



Faculty of Science and Technology

MASTER'S THESIS

Study program/ Specialization: Master in Constructions and Materials (Structure)	Spring semester, 2013 Open
Writer: Abdulkadir Isak Ali (Writer's signature)
Faculty supervisor: Sudath Chaminda Siriwardane External supervisor(s): Kristian Berntsen Eduardo Carlos Hennings-Marianyi	
Thesis title: Human induced vibrations on footbridges	
Credits (ECTS): 30	
Key words: Vibration frequencies Frequencies resonance range Vibration accelerations Analytical calculations. Finite Element Method (FEM) Guidelines: acceleration limits Comfort Class	Pages: 123 + enclosure: 19 pages & CD Stavanger, 01.07.2013 Date/year

Preface

The work of this Master thesis was carried out at the Institute for Construction and Materials Technology (IKM: Institutt for konstruksjonsteknikk og materialteknologi) of Science and Technology Faculty (TEKNAT: Det teknisk-naturvitenskapelige fakultet) at University in Stavanger (UiS) in collaboration with The Norwegian Public Roads Administration (Statens vegvesen), Norway from February to June 2013.

I would like to express my gratitude to all the people who have supported and helped me during this thesis: My supervisor at Institute for Construction and Materials technology (IKM) at the university, Associate professor Sudath Chaminda Siriwardane for his guidance and coordination. I would also like to thank all those at the institute who helped me.

I would like to thank my external supervisor at The Norwegian Public Roads Administration (Statens vegvesen), Kristian Berntsen for directing and connecting to Stavanger Bridge Department (Statens vegvesen), my supervisor at Stavanger Bridge Department: Eduardo Carlos Hennings-Marianyi for his support in ideas and references and Roger Guldvik Ebeltoft (section leader Bridge Department) for task description.

Further I wish to express my deepest gratitude to my family for their unwavering support throughout my education.

Abstract

Most modern footbridges are slender and weight structures which are sensitive to pedestrian induced vibration due to less mass and less stiffness. Pedestrian feel uncomfortable or cannot continue to walk when the step frequencies of pedestrians and natural frequency of the structure coincide or have close range of frequencies in the first 2 modes. Opening ceremony of Millennium Bridge sent a clear signal that only static design is not enough for certain structures.

There are some guidelines on footbridge vibration design, they set critical frequencies range in both vertical and horizontal with simplified SDOF (Single Degree of Freedom) formulas therefore, this thesis will examine whether a designer could be satisfied with these simplified formulas by comparing with FEM (Finite Element Method) results.

In conclusion, the problem which thesis will solve is only confined to this type of bridges i.e. simply supported; other types should be another case to be studied.

Table of Contents

1. Introduction.....	4
1.1. Background.....	4
1.2. Objectives.....	5
2. Vibration theory.....	6
3. Loads	9
3.1. Self-weight	9
3.2. Pedestrian loading	10
4. Design Guidelines.....	14
4.1. Setra [1] and JRC [2]guidelines	14
4.2. Design steps.....	18
4.2.1 Evaluation of natural frequency	19
4.2.2. Check the critical natural frequencies	19
5. Case study	21
5.1. Description of footbridge	22
5.2. Method1: Analytical calculations and results.....	26
5.2.1. Analytical calculations of frequencies and accelerations	31
5.3. Method 2: Dynamic (FEM).....	44
5.3.1. Case 1: Sparse and dense crowds	44
5.3.2. Case 2: Very dense crowd	45
5.4. Method 3: Unconventional Time History created.....	50
5.4.1. Part 1: A group of pedestrians	51
5.4.1. Part 2: Flow of pedestrians gradually increasing/decreasing	53
6. Results of FEM (SAP2000).....	57
6.1. Method 2: Dynamic.....	57
6.1.1. Acceleration results (SAP2000) of dynamic fully loaded (0,5 persons/m ²) direct integration.....	57
6.1.2. Acceleration results (SAP2000) of dynamic fully loaded (0,5 persons/m ²) modal (Ritz vector) 62	62
6.1.3. Acceleration results (SAP2000) of dynamic fully loaded (1 persons/m ²) direct integration.....	68
6.1.4. Acceleration results (SAP2000) of dynamic fully loaded (1 persons/m ²) modal (Ritz vector) 72	72

6.2.	Method 3: (Unconventional Time History).....	78
6.2.1.	Acceleration results (SAP2000) of 2 persons in direct integration	79
6.2.2.	Acceleration results (SAP2000) of 2 persons in modal (Ritz vector)	83
6.2.3.	Acceleration results (SAP2000) of 4 persons in direct integration	89
6.2.4.	Acceleration results (SAP2000) of 4 persons in modal (Ritz vector)	93
6.2.5.	Acceleration results (SAP2000) of fully loaded (0,5 persons/m ²) in direct integration 98	
6.2.6.	Acceleration results (SAP2000) of fully loaded (0,5 persons/m ²) in modal (Ritz vector) 103	
6.2.7.	Acceleration results (SAP2000) of fully loaded (1 persons/m ²) in direct integration 109	
6.2.8.	Acceleration results (SAP2000) of fully loaded (1 persons/m ²) in modal (Ritz vector) 113	
7.	Results	118
7.1.	Collected results from FEM (SAP 2000): Method 2 & Method 3	118
7.2.	Comparing results with the guideline [2]	119
8.	Discussion.....	121
9.	Conclusion.....	123
10.	References	124
11.	Appendices.....	125
11.1.	Appendix 1.	126
11.2.	Appendix 2.....	141
12.	Attachments.....	142

Table of symbols used

a_{limit}	Acceleration limit according to a comfort class	[m/s ²]
a_{max}	maximum acceleration calculated	[m/s ²]
B	useable width of bridge	[m]
d	density of pedestrians on a surface	[P/m ²]
f_n	natural frequency for a considered mode	[Hz] f_s
	step frequency of a pedestrian	[Hz] P
L	length	[m]
k_i	modal stiffness	[N/m]
m_i^*	modal mass	[kg]
M	mass	[kg]
N	number of the pedestrians on the loaded surface S ($N = S \times d$)	
n'	equivalent number of pedestrians on a loaded surface S [P/m ²] $p(t)$ distributed surface load	[kN/m ²]
S	area of the loaded surface	[m ²]
μ	mass distribution per unit length	[kg/m]
$\phi(x)$	mode shape	[-]
Ψ	reduction coefficient account for the probability of a footfall frequency in the range the natural frequency for the considered mode	[-]
ξ	structural damping ratio	[-]

Source:[2]

1. Introduction

1.1. Background

The modern footbridges are mostly slender structure with long span and/or cable stayed and light weighed structure. These have led to decrease mass and stiffness as a consequence. The natural frequencies of these footbridges may coincide with the dynamic response of the moving pedestrians on the bridge. Nowadays this issue become under focus in order to avoid lock-in phenomenon as happened at the Millennium footbridge in 2000 on the opening day started a lateral sway as the many pedestrians started to cross the River Thames, this sent a clear signal that we need breakthrough design and codes for vibration responses.

The Norwegian Public Roads Administration (Statens Vegvesen)/ Bridge Department (Bruseksjon) is interested to analyse footbridges dynamic response by using both Finite Element Method (FEM) and comparing with the analytical calculations of the existing theories; formulas which are state of the art per day.

A proposed footbridge at Gausel train station in Stavanger is considered as the case study of the thesis.



1.2. Objectives

In designing against vibration responses of footbridges there are some guidelines with simplified formulas mainly from Setra: French Footbridge Guideline [1] and Joint Research Centre (Design of Lightweight Footbridges for Human Induced Vibrations) [2] for the calculation of vibration responses.

The main objective of this thesis is to check whether the results of these simplified formulas match with the results of FEM (Finite Element Method) Programme, if these formulas are conservative and still applicable or not close to the results of FEM analyses, which provides more realistic results. Hence this thesis verify that commonly used simple formulas are safe and reliable for footbridges vibration responses by comparing simple formulas with both conventional FEM based approach and newly proposed approach. Motivation of this study is that application of the simple formulas save resources and avoids unnecessary time consumption for design, if those provides a safe and reliable prediction.

Thesis duration is one semester, so this doesn't mean to check all types of footbridges such as cable stayed, arched etc., but it can be an example for the similar types of footbridges.

2. Vibration theory

In vibration theory due to applied dynamic force, excitation force which varies in time, each mode in the structure is usually modelled as a Single Degree Freedom (SDOF) with a harmonic load representing the pedestrian walking along the deck.

In general theory we get the following in SDOF:

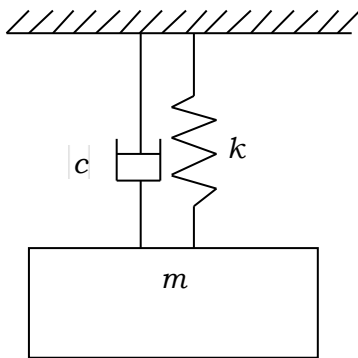

Figur 2.1: Damped free vibration

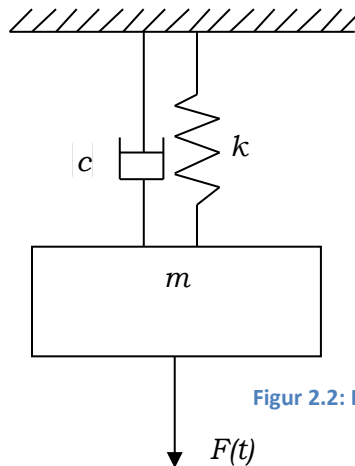

Figur 2.2: Damped forced vibration

Damped free vibration equation

$$m\ddot{x}(t) + c\dot{x}(t) + kx(t) = 0$$

$$\ddot{x} + 2\zeta\omega_n\dot{x} + \omega_n^2x = 0$$

$$\omega_n = \sqrt{\frac{k}{m}} \text{ natural frequency in cycles/sec} = 2\pi f_n \text{ (Hz)}$$

$$\zeta = \frac{c}{2\sqrt{km}} = \text{damping ratio}$$

$$\omega_d = \omega_n\sqrt{1-\zeta^2}$$

$$X = \frac{F_0}{\sqrt{(k - \omega^2m)^2 + (\omega c)^2}} = \frac{\delta_{st}}{\sqrt{(1-r^2)^2 + (2\zeta r)^2}}; \delta_{st} = \frac{F_0}{k}, r = \frac{\omega}{\omega_n}$$

$$\text{Dynamic Amplification Factor (DAF)} = \frac{1}{\sqrt{(1-r^2)^2 + (2\zeta r)^2}} \dots\dots\dots 2.1$$

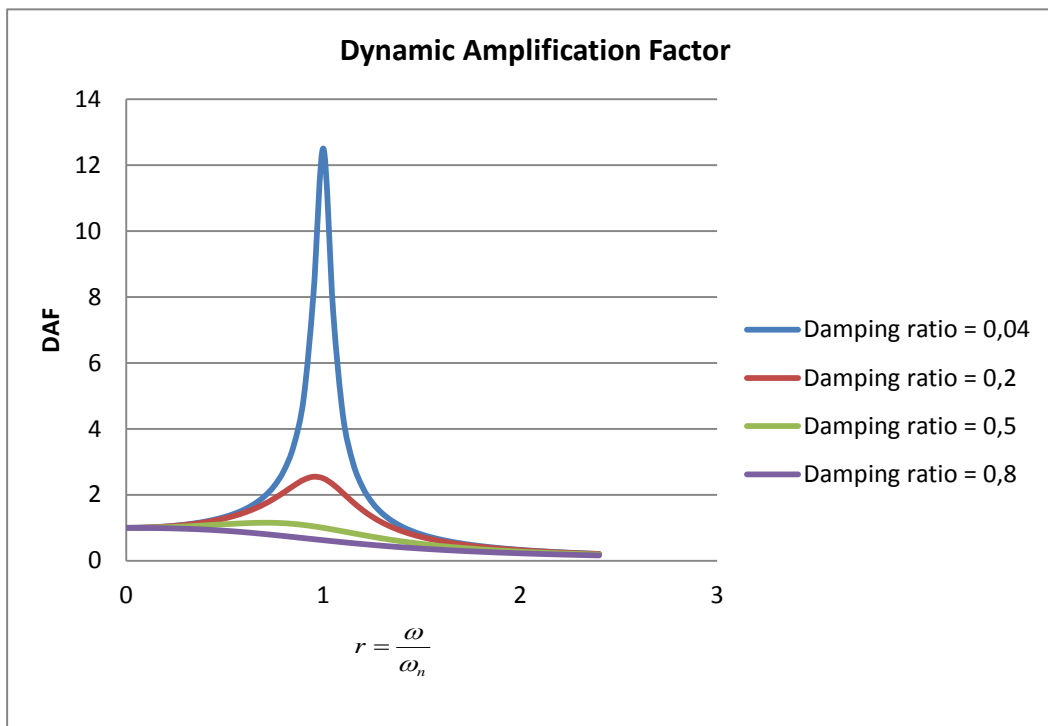

Figur 2.3: Dynamic amplification factor

Damped forced vibration

$$m\ddot{x}(t) + c\dot{x}(t) + kx(t) = F(t)$$

$$\ddot{x}(t) + 2\zeta\omega_n\dot{x}(t) + \omega_n^2 x(t) = \frac{F(t)}{m}$$

$$m\ddot{x}(t) + c\dot{x}(t) + kx(t) = F(t)$$

$$\ddot{x}(t) + 2\zeta\omega_n\dot{x}(t) + \omega_n^2 x(t) = \frac{F(t)}{m} \dots\dots\dots 2.2$$

Whereas :

$\ddot{x}(t)$ = time dependant acceleration.

$\dot{x}(t)$ = time dependent velocity.

$x(t)$ = time dependent displacement.

m = modal mass.

c = Coulomb damping

$F(t)$ = time dependent force

ω_n = natural frequency in cycles/sec = $2\pi f_n$ (Hz)

ω_d = damped frequency in cycles/sec = $2\pi f_d$ (Hz)

f_n = natural frequency in Hz = $\frac{\omega_n}{2\pi}$

3. Loads

Loads are divided mainly in 2 types:

1. Self-weight.
2. Pedestrian weight.

3.1. Self-weight

Include concrete slab, corrugated steel sheet and coating/cover.

Average thickness of concrete slab and coating = $0,13\text{m} + 0,063\text{m} \approx 0,2\text{m}$.

Self-weight for concrete and coating ($2,45 \text{ kN/m}^3$). = $0,2 \text{ m}^3/\text{m}^2 * 2490\text{Kg}/\text{m}^3 =$
498kg/ m²

1 meter length of corrugated steel sheet corresponds to 1,224 m width.

Self-weight of steel sheet = $0,0035 \text{ m}^3/\text{m}^2 * 1,224 * 7850 \text{ Kg}/\text{m}^3 \approx$ **33,63Kg/m²**

Crossbeam (RHS:200*200*10) self-weight = **58,8 kg/m.**

Description		Weight	Corresponding weight /m length
Concrete deck		$498 \text{ kg}/\text{m}^2 * 4,4\text{m}$	2191,2
Steel sheet		$33,63\text{Kg}/\text{m}^2 * 4,4\text{m}$	148
Top and bottom chords (pcs) 300*300*12 (box)		$102 \text{ Kg}/\text{m} * 4\text{m}$	408
Vertical steel boxes	300*300*16	$141\text{Kg}/\text{m} * \frac{1,85}{2} \text{ m}$	130,4
	300*300*12	$104\text{Kg} / \text{m} * \frac{1,85}{2} \text{ m}$	96,2
Braces (tube) 0,1524*0,01		$26,8 \text{ Kg}/\text{m} * 2$	53,6
Cross beam (box) 200*200*10		$58,8 \text{ Kg}/\text{m} * 4,4$	258,72
Total			3286,12*

* = 3184,2 Kg/m² as self-weight (from FEM: calculated from support reaction forces)

3.2. Pedestrian loading

The load of a pedestrian moving at constant speed v can therefore be represented as the product of a time component $F(t)$ by a space component $\delta(x - vt)$, δ being the Dirac operator, that is:

$$P(x,t) = F(t)\delta(x - vt) \quad [1]$$

Several parameters may also affect and modify this load (gait, physiological characteristics and apparel, ground roughness, etc.), but the experimental measurements performed show that it is periodic, characterised by a fundamental parameter: frequency that is the number of steps per second. Below table provides the estimated frequency values.

Designation	Specific features	Frequency range (Hz)
Walking	Continuous contact with the	1.6 to
Running	Discontinuous contact	2 to

Table 3.2.1 [1]

Conventionally, for normal walking (unhampered), frequency may be described by a Gaussian distribution with 2 Hz average and about 0.20 Hz standard deviation (from 0.175 to 0.22, depending on authors). Recent studies and conclusions drawn from recent testing have revealed even lower mean frequencies, around 1.8 Hz - 1.9 Hz.

The periodic function $F(t)$, may therefore be resolved into a Fourier series, that is a constant part increased by an infinite sum of harmonic forces. The sum of all unitary contributions of the terms of this sum returns the total effect of the periodic action.

$$F(t) = G_0 + G_1 \sin 2\pi f_m t + \sum_{i=2}^n G_i \sin(2\pi_i f_m t - \phi_i) \quad 3.2.1.1 \quad [1]$$

with G_0 : static force (pedestrian weight for the vertical component),
 G_1 : first harmonic amplitude,
 G_i : i-th harmonic amplitude,
 f_m : walking frequency,
 ϕ_i : phase angle of the i-th harmonic in relation to the first one,
 n : number of harmonics taken into account.

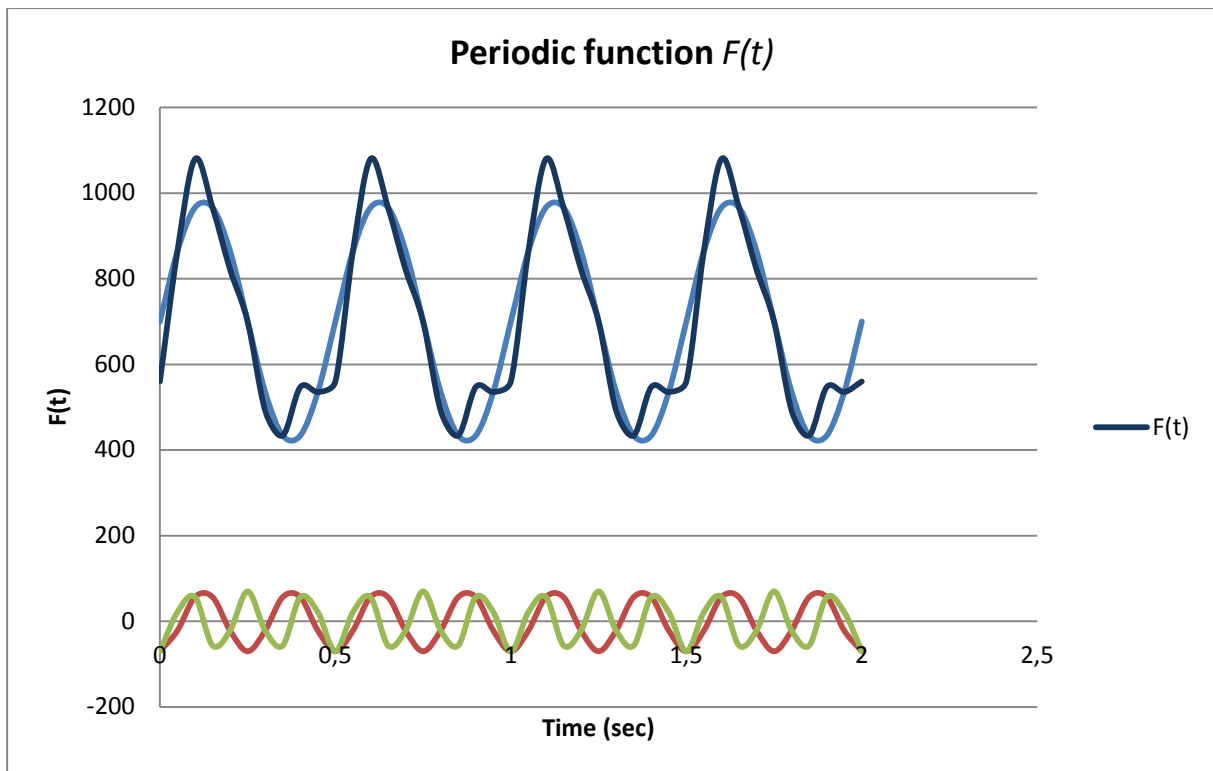

Graph 3.2.1.

The mean value of 700 N may be taken for G_0 , weight of one pedestrian.

At mean frequency, around 2 Hz ($f_m = 2$ Hz) for vertical action, the coefficient values of the Fourier decomposition of $F(t)$ are the following (limited to the first three terms, that is $n = 3$, the coefficients of the higher of the terms being less than 0.1 G_0):

$$G_1 = 0.4 G_0; G_2 = G_3 \approx 0.1 G_0;$$

$$\phi_2 = \phi_3 \approx \pi/2.$$

Vertical component of one-pedestrian load:

$$F_v(t) = G_0 + 0,4G_0 \sin(2\pi f_m t)$$

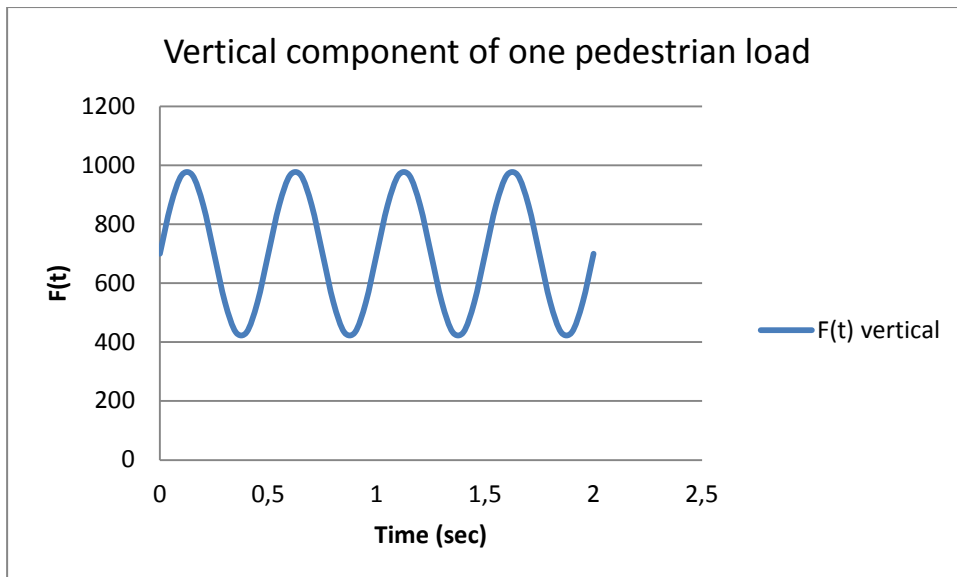

Transverse horizontal component of one-pedestrian load:

$$F_{ht} = 0,05G_0 \sin\left(2\pi\left(\frac{f_m}{2}\right)t\right) \quad 3.2.1.2 \quad [1]$$

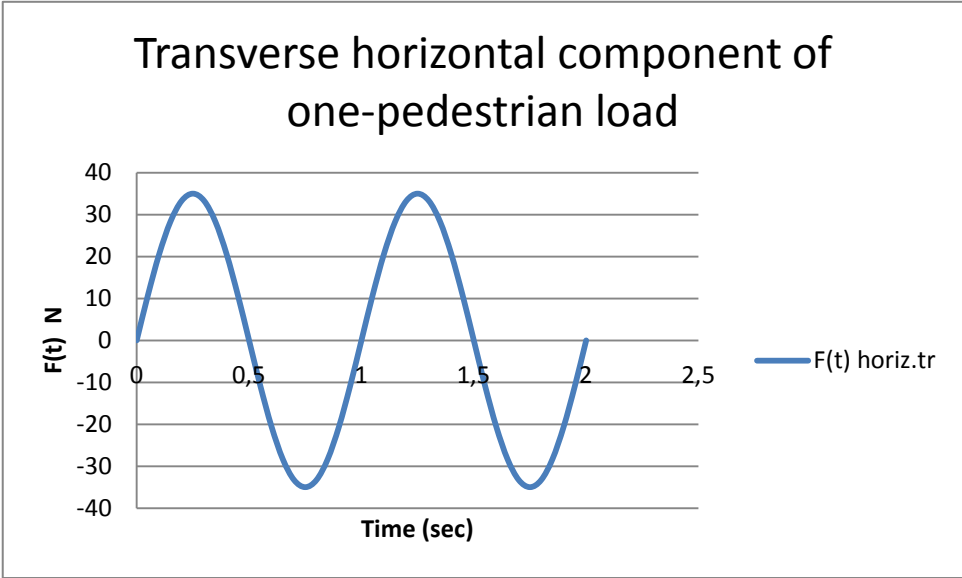

Longitudinal horizontal component of one-pedestrian Load:

$$F_{hl} = 0,2G_0 \sin(2\pi f_n t) \quad 3.2.1.3 \quad [1]$$

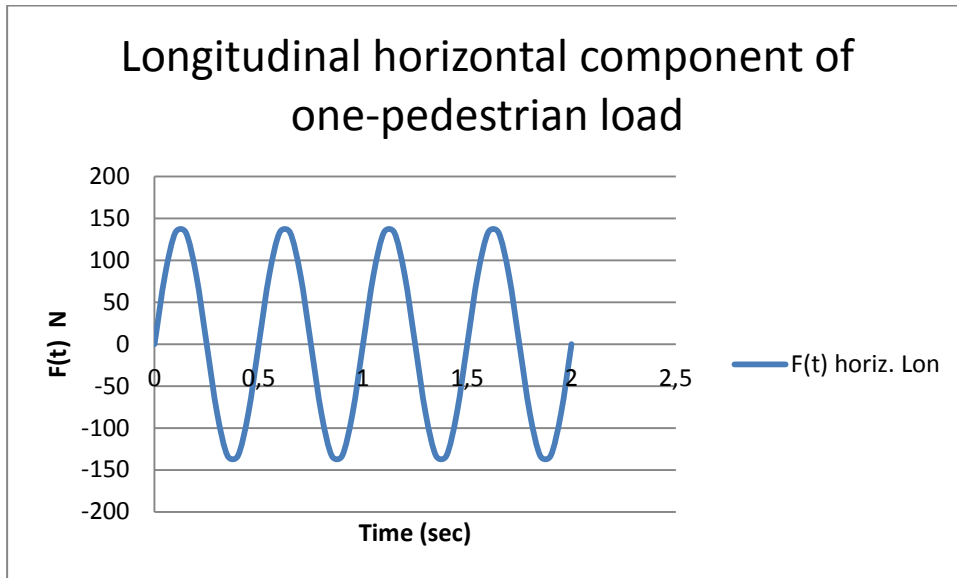

Effects of pedestrians running or deliberate vandal activities or are not dealt here, but follow different groups of pedestrians are in case study.

4. Design Guidelines

Different design guidelines will be taken as reference in this chapter

4.1. Setra [1] and JRC [2] guidelines

These 2 guidelines have common in most of cases, and they set procedures, criteria, formulas and limitations which the case study will follow.

Risk resonance frequencies from Setra Guideline [1]

Factor ψ : reduction factor for 1st harmonic:

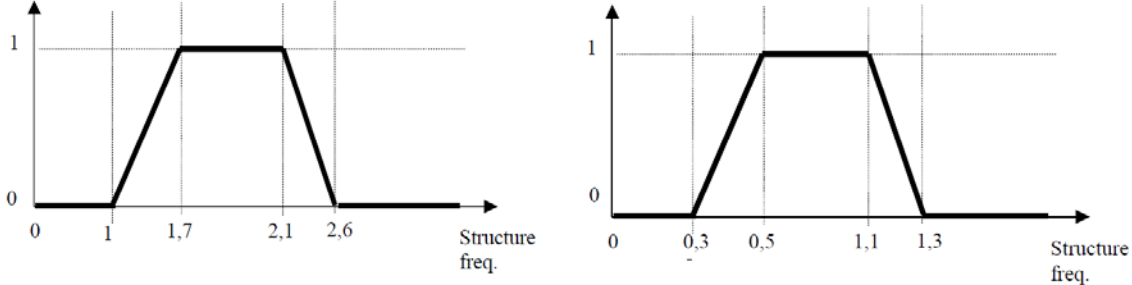

Figure 2.3 : Factor ψ in the case of walking, for vertical and longitudinal vibrations on the left, and for lateral vibrations on the right.

Factor ψ : reduction factor for 2nd harmonic:

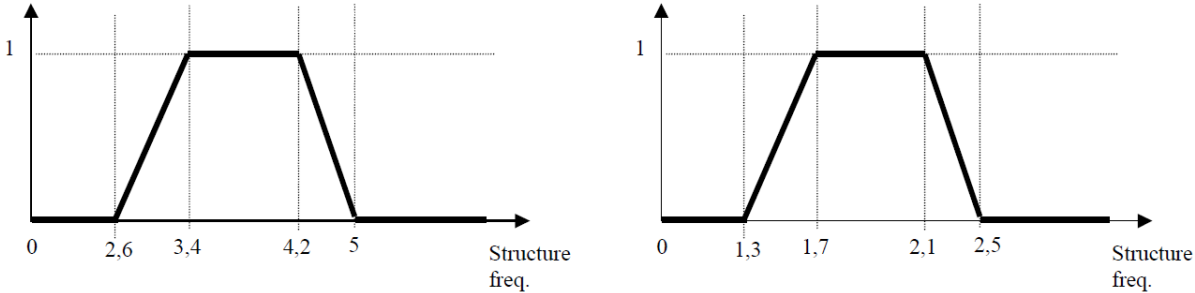

Figure 2.4: Factor ψ for the vertical vibrations on the left and the lateral vibrations on the right

Risk resonance frequencies from JRC Guideline [2] (appendix 2)

Parameters for load model of TC1 to TC5

P [N]		
Vertical 280	Longitudinal 140	Lateral 35
Reduction coefficient ψ		
Equivalent number n' of pedestrians on the loaded surface S for load model of:		
TC1 to TC3 (density $d < 1,0$ P/m ²): $n' = \frac{10,8\sqrt{\xi \times n}}{S}$ [m ²]		
TC4 and TC5 (density $d \geq 1,0$ P/m ²): $n' = \frac{1,85\sqrt{n}}{S}$ [m ²]		

where ξ is the structural damping ratio and,

n is the number of the pedestrians on the loaded surface S ($n = S \times d$).

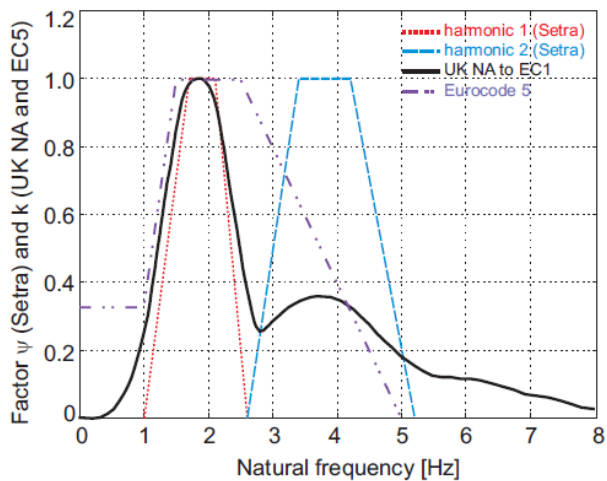

Modelling Spatially Unrestricted Pedestrian Traffic on Footbridges

Stana Živanović*, Aleksandar Pavić[†], Einar Thór Ingólfsson[‡]

JRC [2] has set the following procedures.

The general principles of a proposed design methodology are given in

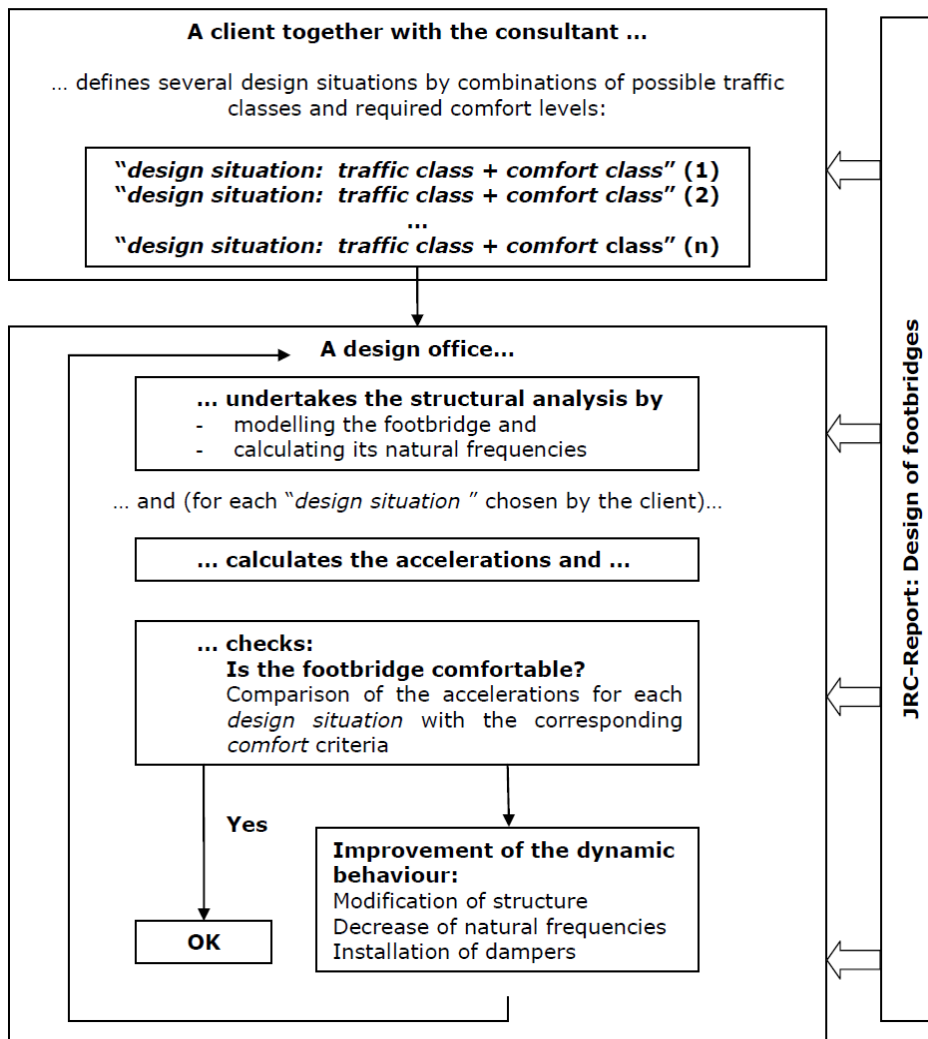

Figure 4.1.1. [2]

4.2. Design steps

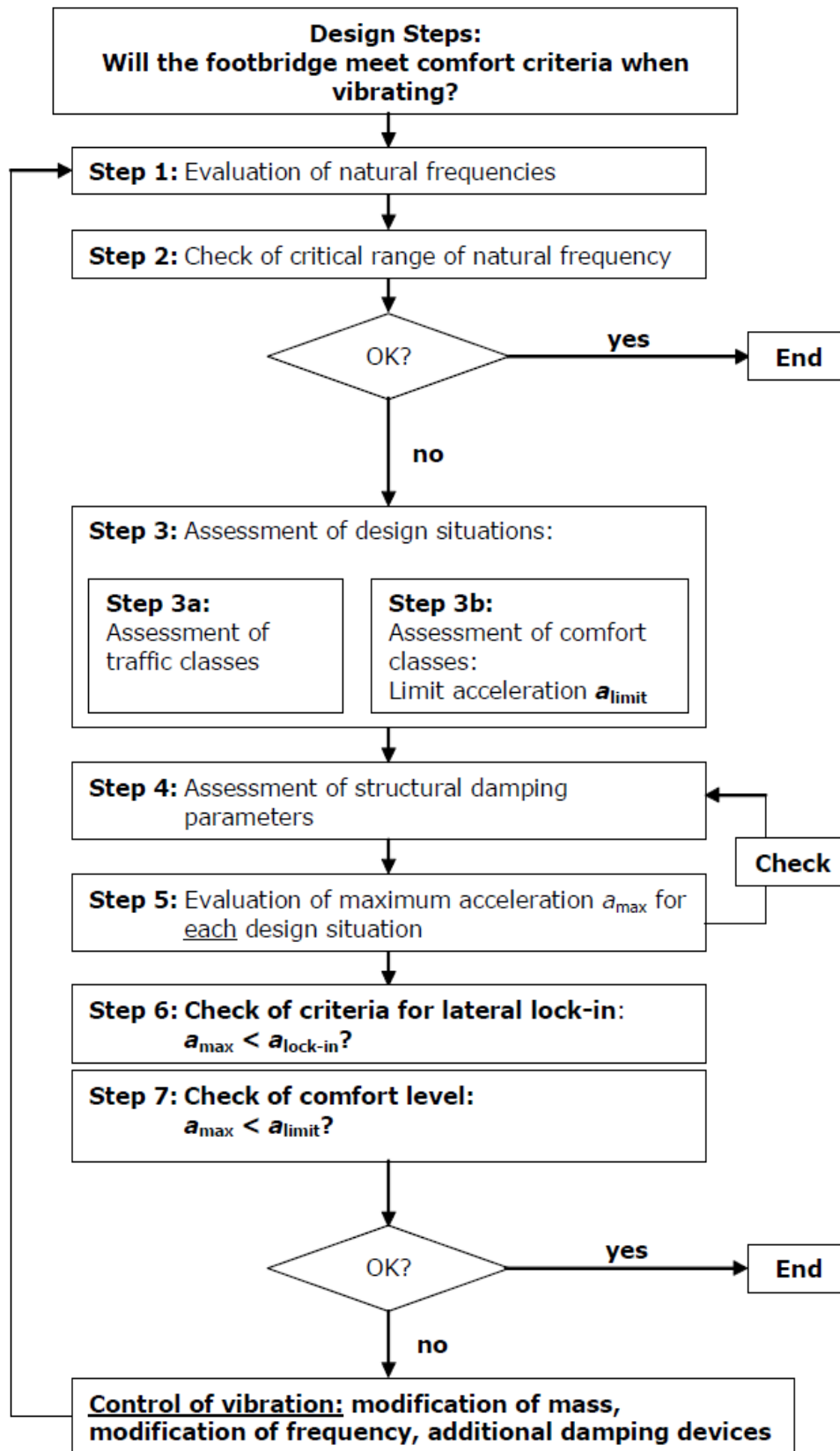

Figure 4.2.1: Flowchart for the use of this guideline [2]

4.2.1 Evaluation of natural frequency

Calculate natural frequency of the bridge by using:

- FEM (Finite Element Method) programme.
- Beam theory vibration, which is suitable for uniform cross-section beam rather than complicated cross-section

4.2.2. Check the critical natural frequencies

Resonance is likely to take place when the natural frequency f_i of the bridge coincide pedestrian step frequency i.e. between following ranges.

- **Range 1:** maximum risk of resonance.
- **Range 2:** medium risk of resonance.
- **Range 3:** low risk of resonance for standard loading situations.
- **Range 4:** negligible risk of resonance.

Frequency	0	1	1.7	2.1	2.6	5
Range 1						
Range 2						
Range 3						

Table 4.2.2: Frequency ranges (Hz) of the vertical and longitudinal vibrations

Frequency	0	0.3	0.5	1.1	1.3	2.5
Range 1						
Range 2						
Range 3						

Table 4.2.3: Frequency ranges (Hz) of the transverse horizontal vibrations [1]

In this thesis we are not deciding comfort class but we are checking the comfort level of the bridge we have here. All the other steps of the follow chart will be followed.

A2.4.3.2 Pedestrian comfort criteria (for serviceability)

(1) The comfort criteria should be defined in terms of maximum acceptable acceleration of any part of the deck.

NOTE The criteria may be defined as appropriate in the National Annex or for the individual project. The following accelerations (m/s^2) are the recommended maximum values for any part of the deck:

- i) 0,7 for vertical vibrations,
- ii) 0,2 for horizontal vibrations due to normal use,
- iii) 0,4 for exceptional crowd conditions.

(2) A verification of the comfort criteria should be performed if the fundamental frequency of the deck is less than:

- 5 Hz for vertical vibrations,
- 2,5 Hz for horizontal (lateral) and torsional vibrations.

NOTE The data used in the calculations, and therefore the results, are subject to very high uncertainties. When the comfort criteria are not satisfied with a significant margin, it may be necessary to make provision in the design for the possible installation of dampers in the structure after its completion. In such cases the designer should consider and identify any requirements for commissioning tests.

[4]

Design situation: this bridge is already designed, only vibration response will be examined.

Methods for calculating the maximum acceleration [1]

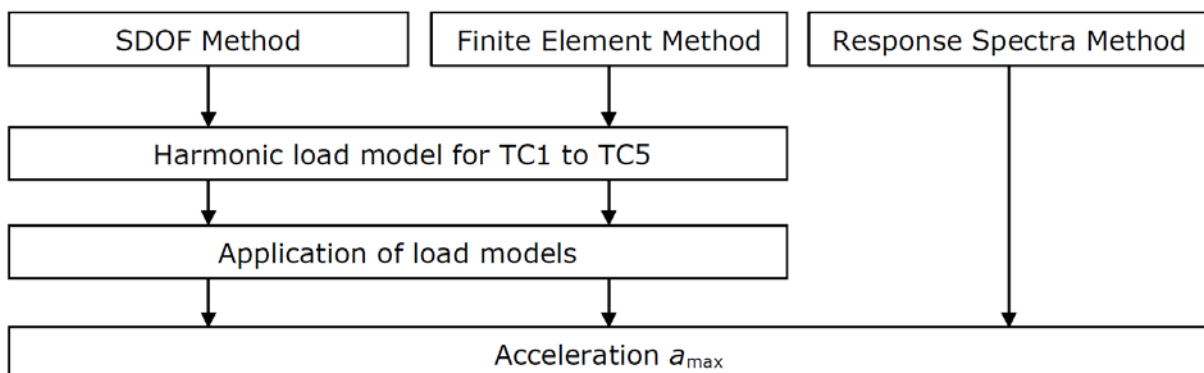

5. Case study

This is the main part of this thesis to study an example footbridge in different methods by using FEM (Finite Element Method) programme and analytical calculations.

This performed as following:

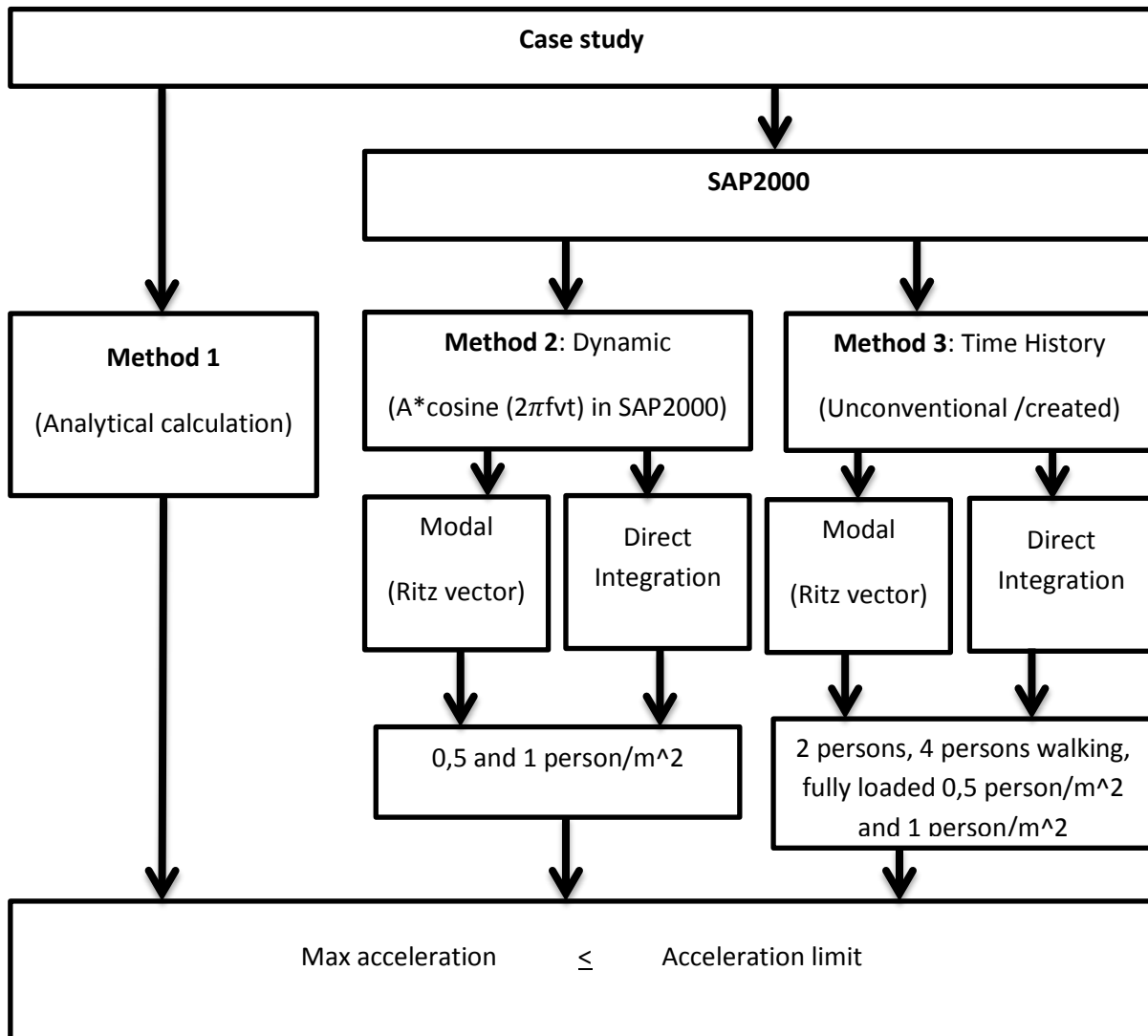

5.1. Description of footbridge

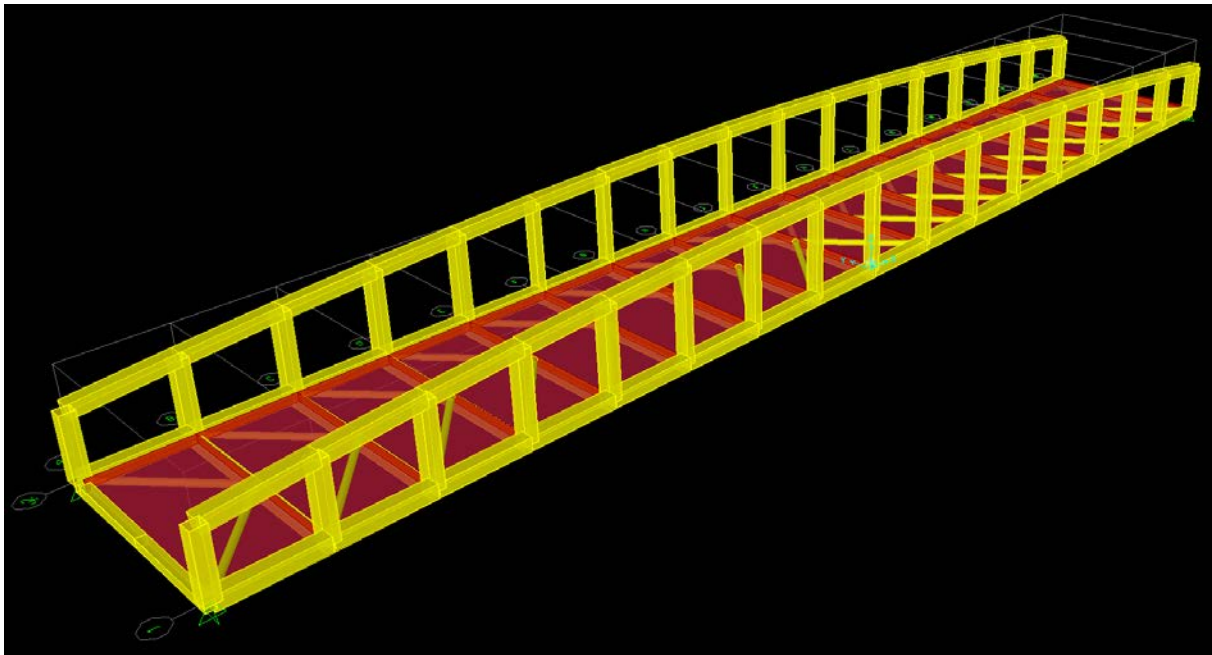

Figure 5.1.1: 3D view of the bridge

Bridge type	:	Steel frame simply supported footbridge with concrete deck
Spann	:	32 m
Useable breadth	:	4 m
Height	:	between 1,4 m to 2,30 m

For more information refer appendix.

Joint numbers:

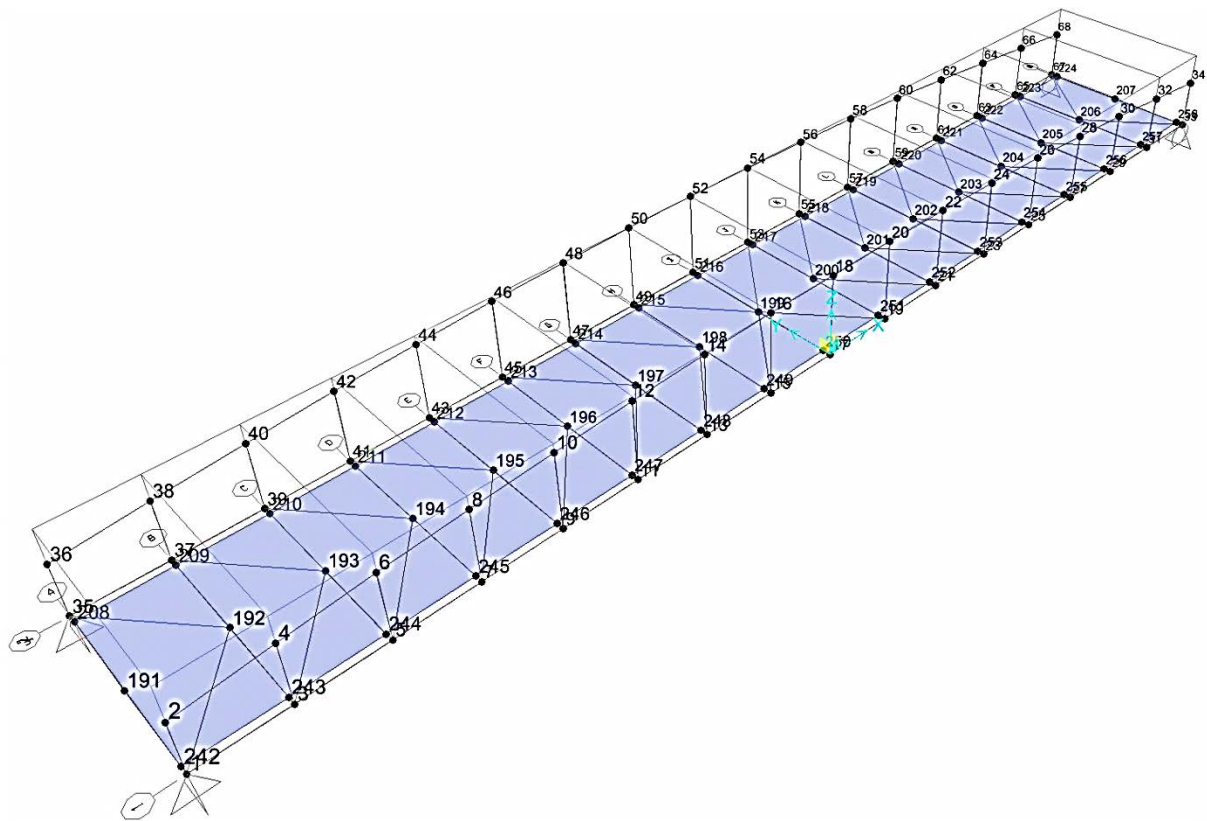

Figure 5.1.2: Joints numbering in 3D

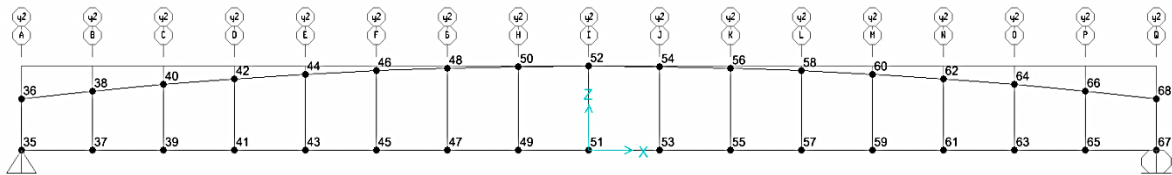

Figure 5.1.3: Joints numbering X-Z plane @ Y= 4,8m

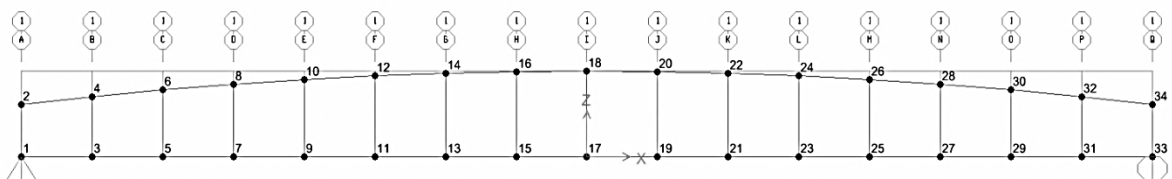

Figure 5.1.4: Joints numbering X-Z plane @ Y= 0

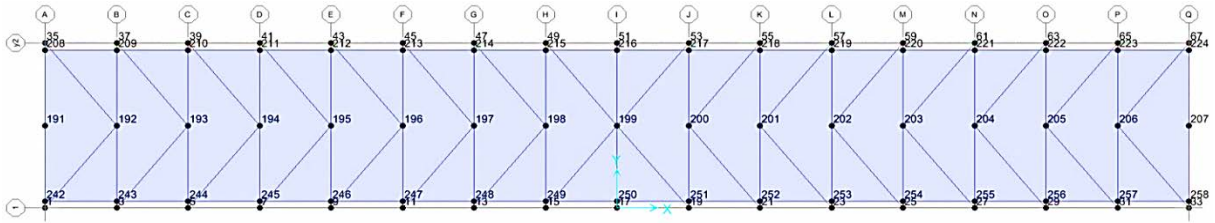

Figure 5.1.5: Joints numbering X-Y plane @ Y=0m

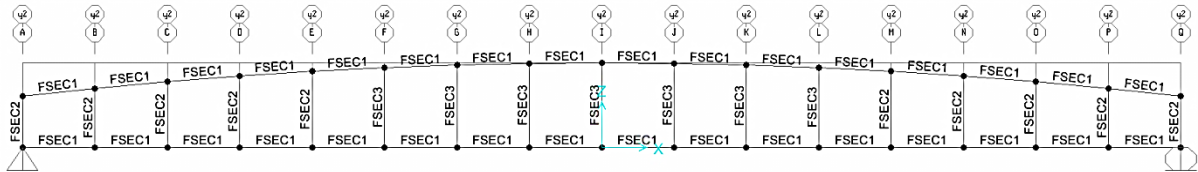

Figure 5.1.6: Section properties 1

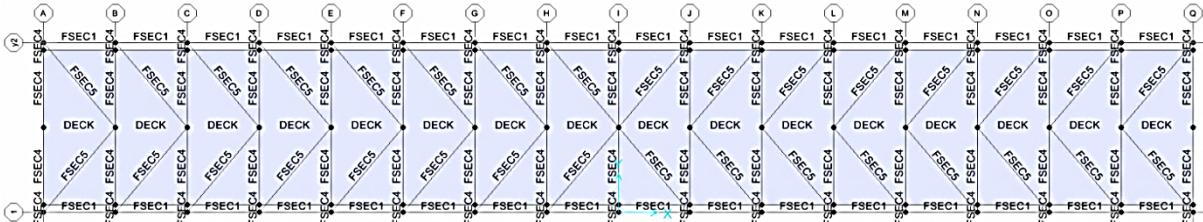

Figure 5.1.7: Section properties 2

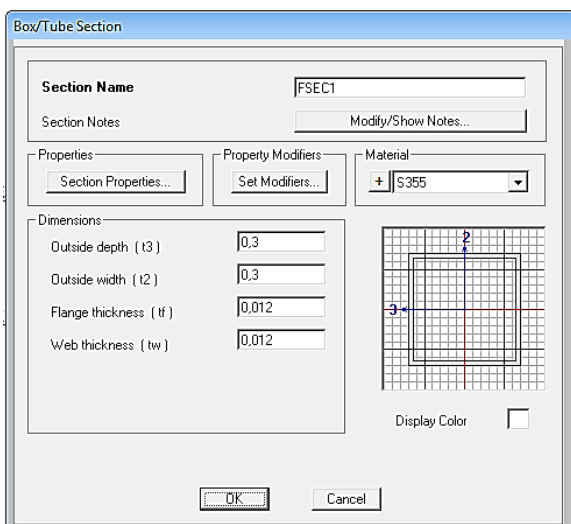

Figure 5.1.8: Section properties : FSEC1 = Steel box (300*300*12)

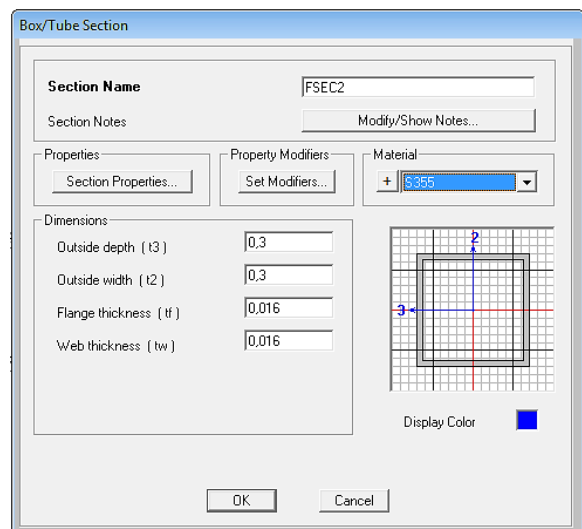

Figure 5.1.9: Section properties : FSEC2 = Steel box (300*300*16)

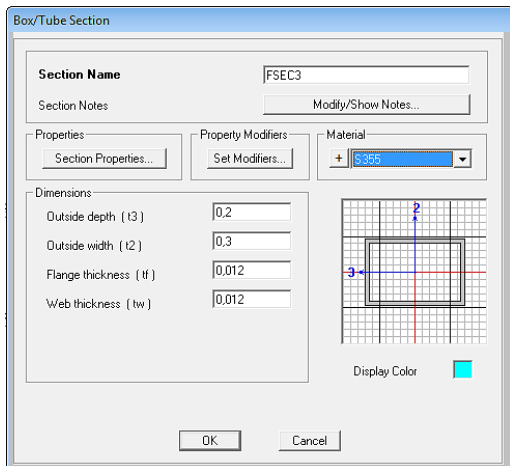

Figure 5.1.10: Section properties : FSEC3 = Steel box (200*300*12)

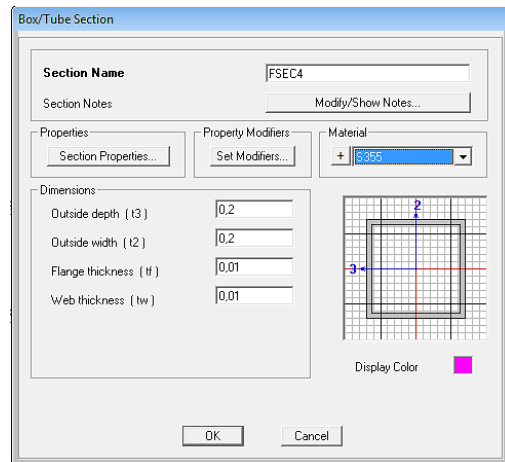

Figure 5.1.11: Section properties : FSEC4 = Steel box (200*200*10)

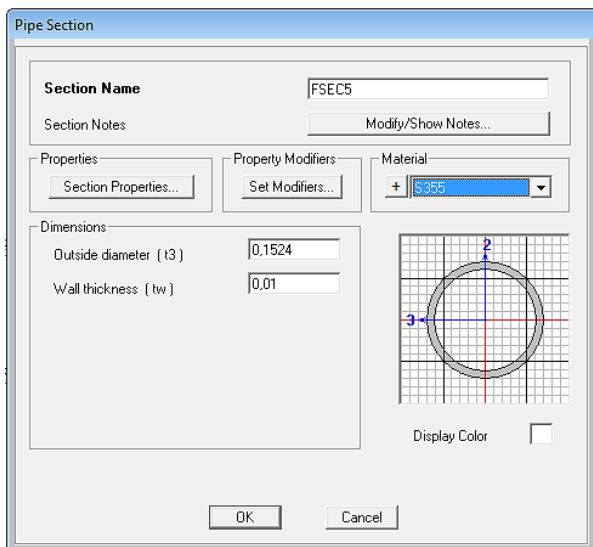

Figure 5.1.12: Section properties : FSEC5 = Steel pipe (D=152,4, t=10)

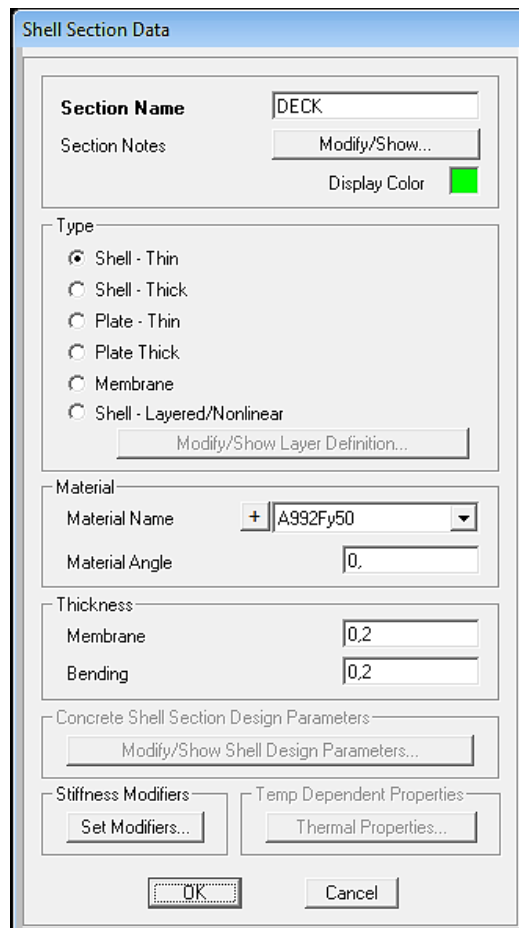

Figure 5.1.13: Section properties : DECK = Concrete (t=200)

5.2. Method1: Analytical calculations and results

To get the most accurate results one has to calculate the 2nd moment of inertia() in both Y and Z directions precisely since most bridges have no uniform cross section geometrically and made of non-homogeneous materials such as steel and concrete.

In this case I_{yy} and I_{zz} are calculated from:

- Normal calculation taking the average height as 1,85 m since the top girder/chord is arched and taking concrete section as homogenized in 1st Y direction and 2nd in Z

direction i.e. $\frac{E_{steel}}{E_{concrete}} = \frac{210 * 10^9 N / m^2}{26 * 10^9 N / m^2} = 8,077$ by dividing 8,077 the width or

thickness of the concrete depending which direction to homogenize.

- Calculating only I_{yy} and I_{zz} of steel frame, this may result frequencies out of resonance range i.e. false sense of security.
- Calculating I_{yy} and I_{zz} from deflections found from FEM programme.

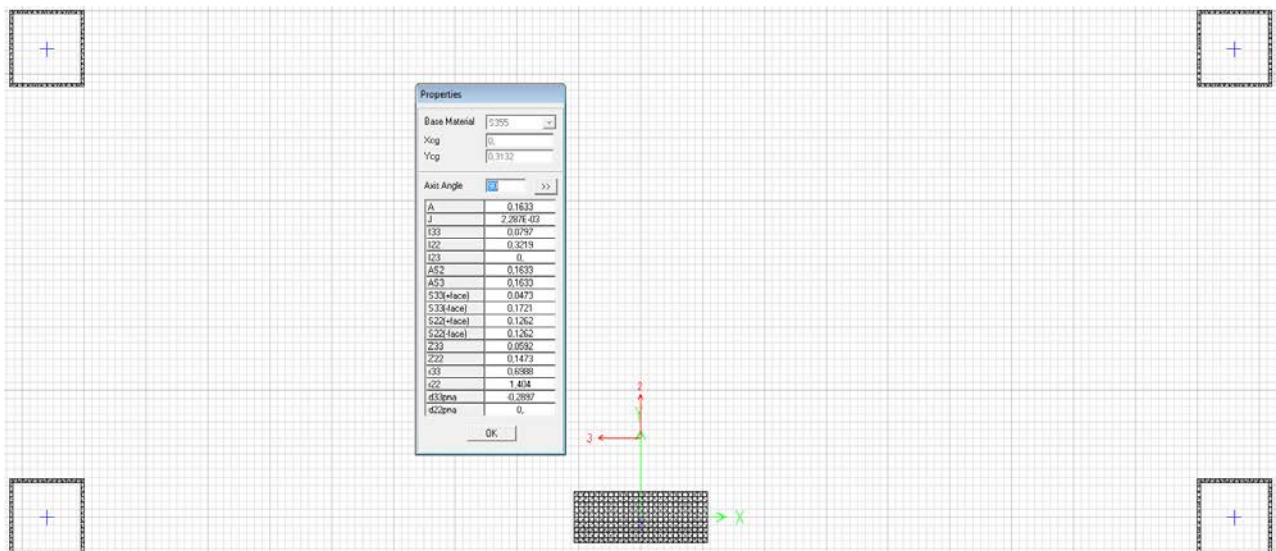

Cross section properties of homogenized different materials (in y-y or 3-3) for vertical stiffness.

$I_{yy} = I_{33} = 0,0797 \text{ m}^4$ in manual 0,05464134

$I_{zz} = I_{22} = 0,3219 \text{ m}^4$

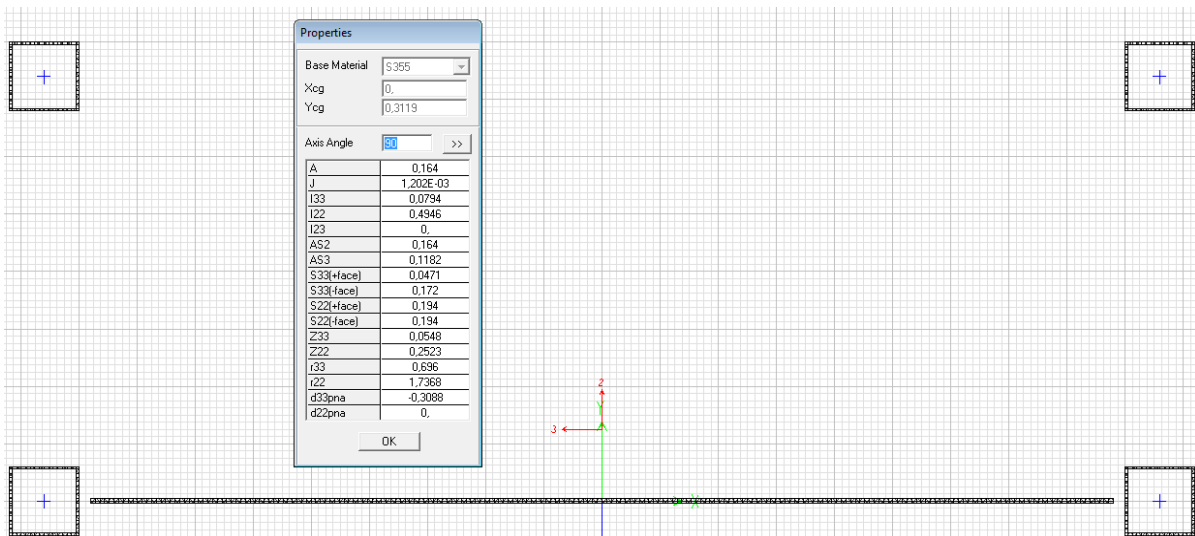

Cross section properties of homogenized different materials (in z-z or y 2-2 axis) for horizontal stiffness.

$$I_{yy} = I_{33} = 0,0794 \text{ m}^4$$

$$I_{zz} = I_{22} = 0,4946 \text{ m}^4$$

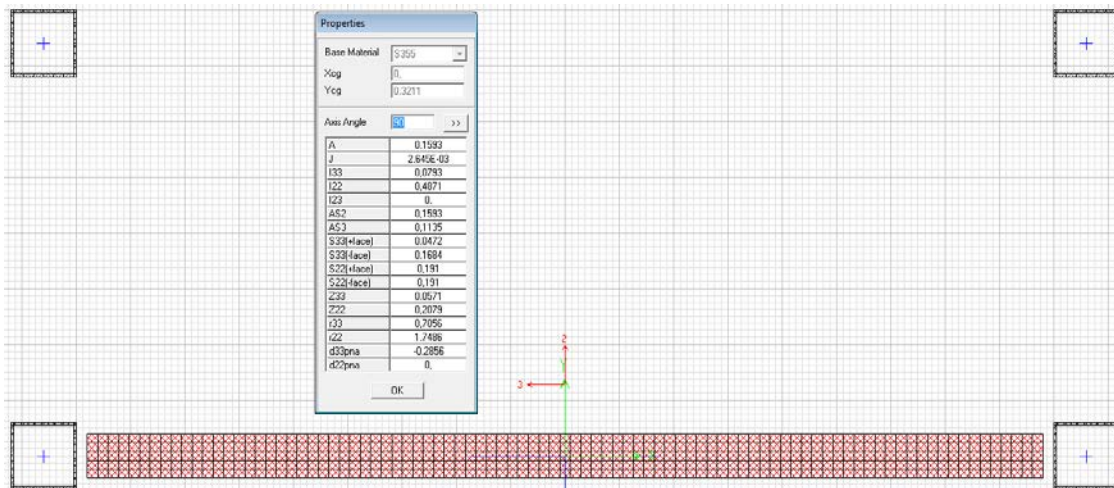

Cross section properties considered different types of materials.

$$I_{yy} = I_{33} = 0,0793 \text{ m}^4$$

$$I_{zz} = I_{22} = 0,4871 \text{ m}^4$$

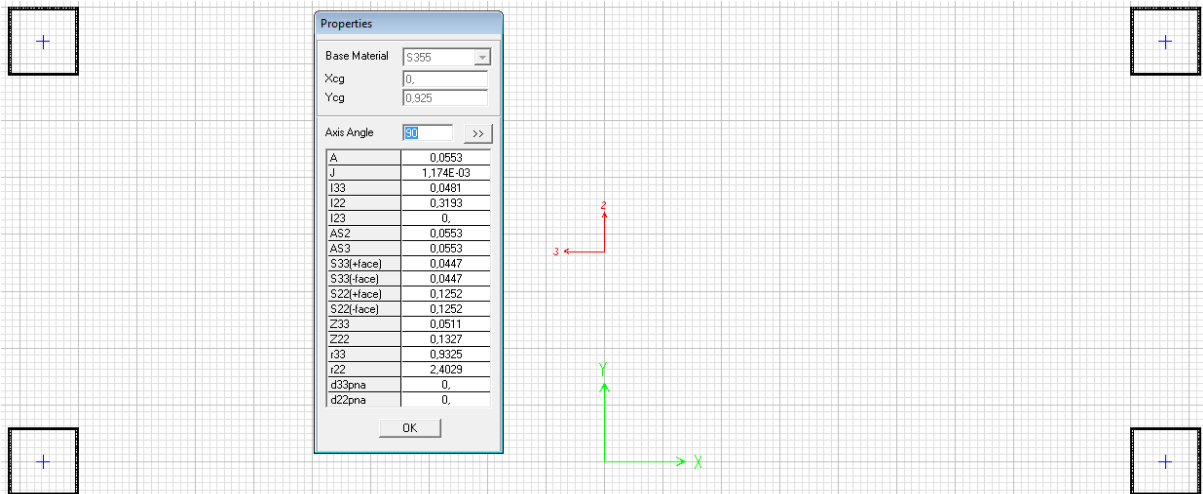

Cross section properties of steel frame, concrete deck is not considered as stiffness contributor.

$I_{yy} = I_{33} = 0,0481 \text{ m}^4$ (reasonable)

$I_{zz} = I_{22} = 0,3193 \text{ m}^4$

Calculation of I (moment of inertia) from the deflection.

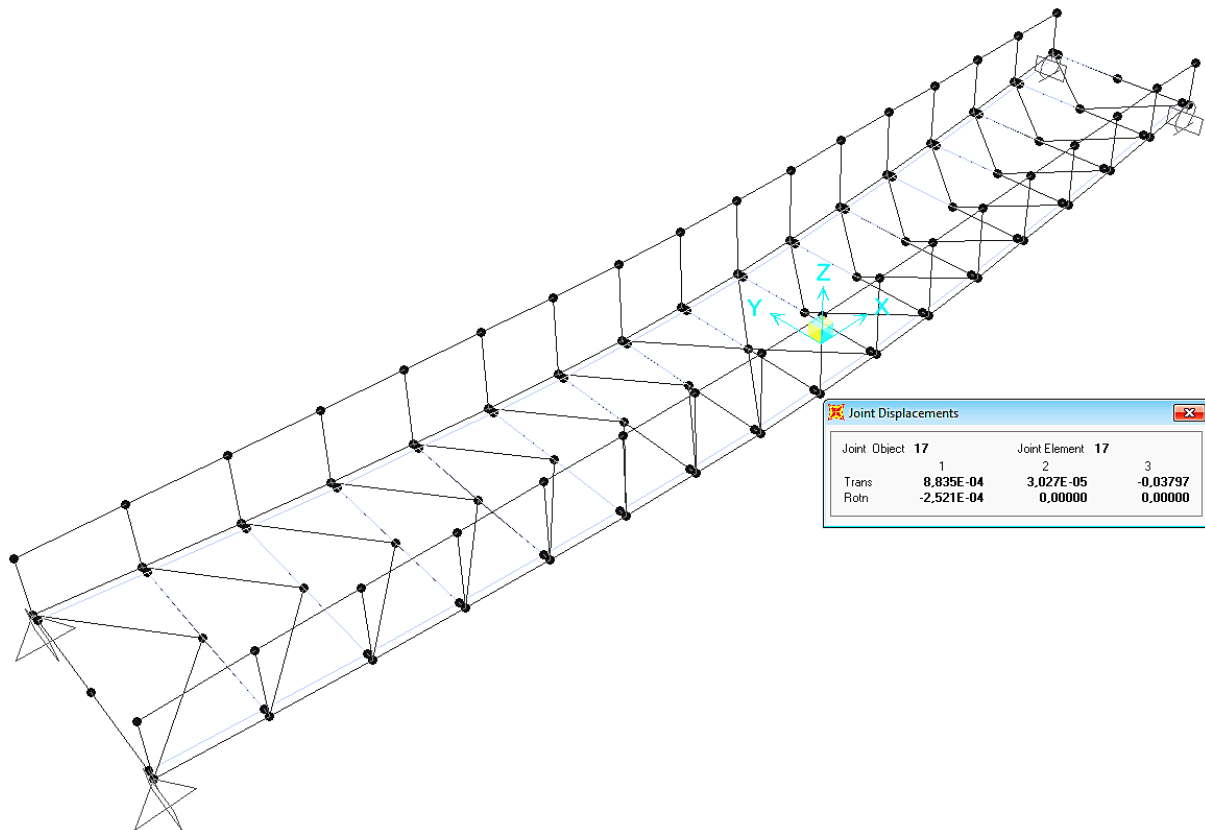

Deflection i vertical direction (Z)

$$W_{\max} = 5 \frac{ql^4}{384 * EI_{\text{vert}}} = 0,03797m$$

Where :

$$E_{\text{steel}} = 210 * 10^9 \text{ N} / \text{m}^2$$

$$q = 3184,2 \text{ Kg} / \text{m} * 9,81 \text{ m} / \text{sec}^2 = 31237 \text{ N}$$

$$l = 32 \text{ m}$$

$$W_{\max} = 5 \frac{31237 * 32^4}{384 * EI} = 0,03797 \text{ m}$$

$$\Rightarrow EI_{\text{vert}} = 5 \frac{31237 * 32^4}{384 * (0,03797)} = 1,123226688 * 10^{10} \text{ Nm}^2$$

$$\Rightarrow I_{\text{vert}} = \frac{1,123226688 * 10^{10} \text{ Nm}^2}{E} = \frac{1,123226688 * 10^{10} \text{ Nm}^2}{210 * 10^6 \text{ kN} / \text{m}^2}$$

$$I_{\text{vert}} = \underline{\underline{0,053487 \text{ m}^4}}$$

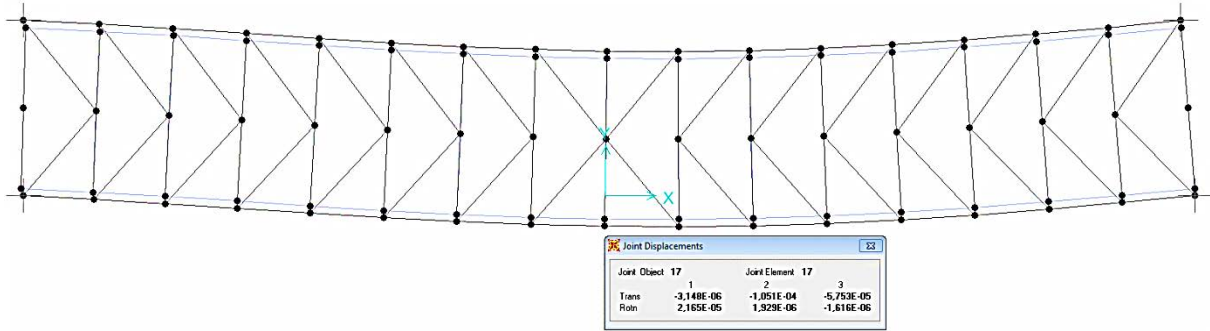

Deflection i horizontal direction (Y):

Uniformly distributed load (UDL) of 981N is applied in -Y direction in order to have a horizontal deflection.

$$W_{\max} = 5 \frac{ql^4}{384 * EI_{\text{horiz}}} = 1,051 * 10^{-4} m$$

Where :

$$E_{\text{steel}} = 210 * 10^9 N / m^2$$

$$q = 100 Kg / m * 9,81 m / \text{sec}^2 = 981 N$$

$$l = 32 m$$

$$W_{\max} = 5 \frac{981 * 32^4}{384 * EI} = 1,051 * 10^{-4} m$$

$$\Rightarrow EI_{\text{horiz}} = 5 \frac{981 * 32^4}{384 * (1,051 * 10^{-4})} = 12,74397716 * 10^{10} Nm^2$$

$$\Rightarrow I_{\text{horiz}} = \frac{12,74397716 * 10^{10} Nm^2}{E} = \frac{12,74397716 * 10^{10} Nm^2}{210 * 10^6 kN / m^2}$$

$$I_{\text{horiz}} = \underline{\underline{0,6068 m^4}}$$

5.2.1. Analytical calculations of frequencies and accelerations

The analytical calculations are taken from Setra [1] and JRC [2] guidelines.

Damping:

An important summary document dealing with the general problem of structure vibrations provides the following values for use in projects:

Type of deck	Critical damping ratio	
	Minimum value	Average value
Reinforced concrete	0.8%	1.3%
Prestressed concrete	0.5%	1.0%
Metal	0.2%	0.4%
Mixed	0.3%	0.6%
Timber	1.5%	3.0%

Table 5.2.1.1 [1]

5.2.1.1. 2 persons walking

Vertical acceleration induced by 2 persons:

$$f_n = \frac{n^2 \pi}{2L^2} \sqrt{\frac{EI}{\rho S}} \quad [1]$$

Where:

- f_n = Natural frequency of mode n in Hz
- n = Mode number
- L = Length of bridge
- E = Elastic modulus
- I = 2nd moment of inertia
- ρS = Density of bridge per meter length (kg/m)

Useable width of the deck	B = 4 m
Length of the span	L = 32 m
Mass (m)* = 3184,2kg/m + 2 persons	$\rho S^* = 3188,6 \text{ Kg/m}$
Stiffness	EI(vertical) = 1,1232E+10 Nm ²
	EI(lateral) = 1,27E+11 Nm ²
Damping ratio	$\xi = 0,004$

$$\rho S^* = 3184,2 \text{ kg/m} + (140 \text{ Kg}/32 \text{ m})$$

Mode	EI(vert)	ρS (kg/m)	L(m)	Freq.Hz (SAP)	Freq. Hz (Analytic)
1	1,1232E+10	3188,6	32	2,88672783	2,87907916
2	1,1232E+10	3188,6	32	5,21263539	11,5163167
3	1,1232E+10	3188,6	32	8,62734954	25,9117125

Acceleration formula [2]

$$a_{\max,d} = k_{a,d} \sigma a$$

Generalized mass: [2]

$$M = \frac{1}{2} \mu L$$

$$M = \frac{1}{2} * 3188,6 * 32 = 51017,6 \text{ Kg.}$$

Taking 1st mode vertical (**2,879 Hz**) which is the closest to resonance frequency range (1,25 – 2,3 Hz) [2], other modes are over the range.

According guidelines [1] & [2] no need to calculate the acceleration of frequencies out of resonance range i.e. reduction factor (ψ) = 0

Resonance frequencies defined by Guidelines				
	Setra [1]		Guideline [2]	
Harmonic	Vertical Hz	Horizontal Hz	Vertical Hz	Horizontal Hz
1 st	1 – 2,6	0,3 – 1,3	1,25 – 2,3	0,5 – 1,2
2 nd	2,6 - 5	1,3 - 25	2,5 – 4,6	-

The guidelines only deal with fully distributed load of different pedestrian densities but we need analytical results to compare with the results from FEM.

f1 (Hz)	a1	a2	a3	k1
2,879079164	-0,07	0,6	0,075	1,22221072

f1 (Hz)	b1	b2	b3	k2
2,879079164	0,003	-0,04	-1	-1,09029588

d (person/m2)	B (m)	L (m)	kF	n	(σ _F) ²
Not applicable	4	2	1,20E-02	2	2,40E-02

k1	k2	ξ	C	(σ _F) ²	Generalized mass (kg)	(σ _a) ²
1,22221072	-1,090295876	0,004	2,95	0,024	51017,6	1,36837E-08

$$a_{\max, d} = k_{a, d} \sigma_a$$

Where:

$$a_{\max, d} = a_{\max, 95\%}$$

$$k_{a,d} = k_{a,95\%}$$

$k_{a,95\%}$	$(\sigma a)^2$	$a_{max,95\%}$
3,92	1,36837E-08	0,000458551

Maximum acceleration = 0,000458 m/sec²

Reduction factor (ψ) = 0 (for 2,88 Hz vertical vibration) i.e.

acceleration = 0 (vertical)

Horizontal acceleration induced by 2 persons

Table: Constants for lateral accelerations [2]

d [P/m ²]	k_F	C	a_1	a_2	a_3	b_1	b_2	b_3	$k_{a,95\%}$
$\leq 0,5$	$2,85 \times 10^{-4}$	6,8	-0,08	0,50	0,085	0,005	-0,06	-1,005	3,77
1,0		7,9	-0,08	0,44	0,096	0,007	-0,071	-1,000	3,73
1,5		12,6	-0,07	0,31	0,120	0,009	-0,094	-1,020	3,63

Horizontal modes for 2 persons

Mode	EI(horiz)	rS (kg/m)	L(m)	Freq. Hz (Analytic)
1	1,27E+11	3188,6	32	9,69778143
2	1,27E+11	3188,6	32	38,7911257
3	1,27E+11	3188,6	32	87,2800329

It is satisfied since the above frequencies are not in the range or coincide the pedestrians' lateral step frequency i.e. reduction factor (ψ) = 0

If continue analytical calculations regardless the reduction factor (ψ) we get the following:

f1 (Hz)	a1	a2	a3	k1
9,69779012	-0,08	0,5	0,085	-2,5898756

f1 (Hz)	b1	b2	b3	k2
9,697790122	0,005	-0,06	-1,005	-1,11663174

d (person/m2)	B (m)	L (m)	kF	n	(σ_F)^2
Not applicable	4	32	2,85E-04	2	5,70E-04

k1	k2	ξ	C	(σ_F)^2	Generalized mass (kg)	(σ_a)^2
-2,589875599	-1,11663174	0,004	6,8	5,70E-04	51017,2	-1,83588E-09

(σ_a)² = **-1,83588E-09** because k1 = -2,589875599 i.e. (σ_a) is a complex number due to the value of frequency (main factor) see the graph.

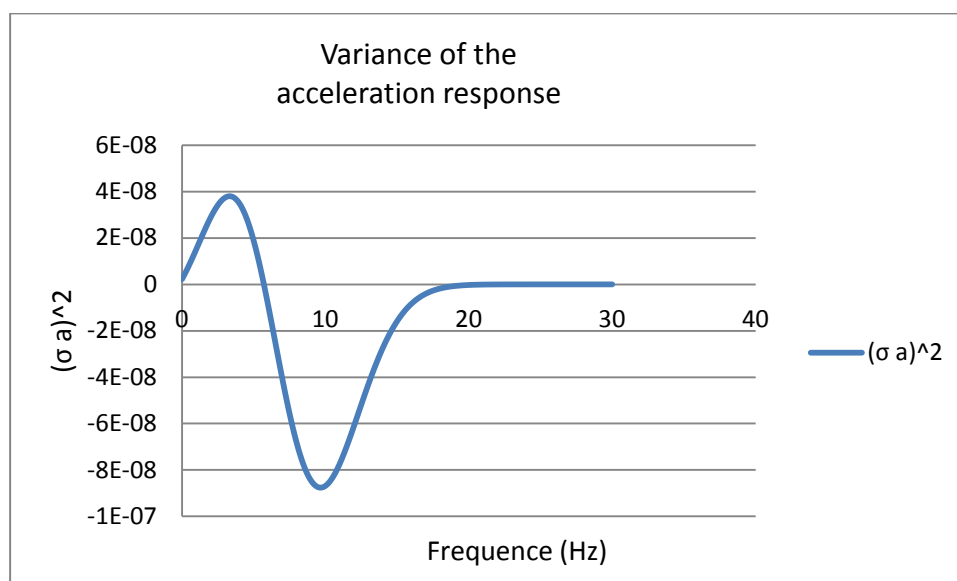

Graph: frequency over 5,7 Hz gives negative variance (σ_a)² of the acceleration response.

Absolute value of variance result:

$$a_{\max,d} = k_{a,d} \sigma_a$$

Where:

$$a_{\max,d} = a_{\max,95\%}$$

$$k_{a,d} = k_{a,95\%}$$

$k_{a,95\%}$	$(\sigma_a)^2$	$a_{\max,95\%}$
3,77	1,84E-09	<u>1,62E-04</u>

5.21.2. 4 persons walking

Vertical acceleration induced by 4 persons:

Vertical modes for 4 persons

Mode	EI(vert)	rS (kg/m)	L(m)	Freq. (Analytic) Hz
1	1,1232E+10	3193	32	2,87709477
2	1,1232E+10	3193	32	11,5083791
3	1,1232E+10	3193	32	25,893853

f1 (Hz)	a1	a2	a3	k1
2,87709477	-0,07	0,6	0,075	1,22181966

f1 (Hz)	b1	b2	b3	k2
2,87709477	0,003	-0,04	-1	-1,09025077

d (person/m2)	B (m)	L (m)	kF	n	$(\sigma F)^2$
Not applicable	4	32	1,20E-02	4	4,80E-02

k1	k2	ξ	C	$(\sigma F)^2$	Generalized mass (kg)	$(\sigma a)^2$
1,22181966	-1,09025077	0,004	2,95	4,80E-02	51088	2,7276E-08

ka,95%	$(\sigma a)^2$	$a_{max,95\%}$
3,92	2,73E-08	6,47E-04

Horizontal acceleration induced by 4 persons:

Horizontal modes for 4 persons

Mode	EI(horiz)		L(m)	fn (Analytic) Hz
1	1,27E+11	3193	32	9,69109729
2	1,27E+11	3193	32	38,7643891
3	1,27E+11	3193	32	87,2198756

f1 (Hz)	a1	a2	a3	k1
9,69109729	-0,08	0,5	0,085	-2,5828406

f1 (Hz)	b1	b2	b3	k2
9,69109729	0,005	- 0,06	-1,005	-1,116879

d (pers/m2)	B (m)	L (m)	kF	n	$(\sigma F)^2$
Not applicable	4	32	2,85E-04	4	1,14E-03

k1	k2	ξ	C	$(\sigma F)^2$	Generalized mass (kg)	$(\sigma a)^2$
-2,5828406	-1,116	0,004	6,8	1,14E-03	51088	-3,656E-09

If we use absolute value of $(\sigma a)^2$ then we get the following maximum acceleration.

<i>ka,95%</i>	$(\sigma a)^2$	<i>amax,95%</i>
3,77	3,66E-09	2,28E-04

Fully loaded with 0,5 person/m² (64 pedestrians of average weight 70 kg each)

d (person/m²)	B (m)	L (m)	kF	n	(σF)²
0,5	4	32	1,20E-02	64	7,68E-01

k1	k2	ξ	C	(σF)²	Generalized mass (kg)	(σa)²
1,22221072	-1,09029588	0,004	2,95	0,768	53251,2	4,0192E-07

<i>ka,95%</i>	$(\sigma a)^2$	<i>amax,95%</i>
3,92	4,0192E-07	0,00248515

Maximum acceleration = 0,002485 m/sec²

Reduction factor (ψ) = 0 (for 2,88 Hz vertical vibration) i.e.

acceleration = 0 (vertical)

5.2.1.2. Fully loaded with 0,5 person/m²

Vertical acceleration induced by fully loaded (0,5 person/m²)

(64 pedestrians of average weight 70 kg each)

Mode	EI(vert)		L(m)	Freq. Hz (Analytic)
1	1,1E+10	3324,2	32	2,8197464
2	1,1E+10	3324,2	32	11,278986
3	1,1E+10	3324,2	32	25,377718

Frequencies (2,819 Hz.) are above the range and no analytical calculations are needed but continuing as started previously.

f1 (Hz)	a1	a2	a3	k1
2,8197464	-0,07	0,6	0,075	1,21027996

f1 (Hz)	b1	b2	b3	k2
2,8197464	0,003	-0,04	-1	-1,08893695

d (person/m²)	B (m)	L (m)	k_F	n	(σ_F)²
0,5	4	32	1,20E-02	64	7,68E-01

k1	k2	ξ	C	(σ_F)²	Generalized mass (kg)	(σ_a)²
1,21027996	-1,08893695	0,004	2,95	0,768	53187,2	3,9597E-07

k_{a,95%}	(σ_a)²	a_{max,95%}
3,92	3,9597E-07	0,0024667

Horizontal acceleration induced by fully loaded (0,5 person/m²)

(64 pedestrians of average weight 70 kg each)

Mode	EI(horiz)	ρ S (kg/m)	L(m)	Freq. Hz (Analytic)
1	1,27E+11	3324,2	32	9,49792728
2	1,27E+11	3324,2	32	37,9917091
3	1,27E+11	3324,2	32	85,4813455

Frequencies continue to be above the range (9,497 Hz) i.e. no analytical calculations needed to perform since reduction factor (ψ) = 0

f1 (Hz)	a1	a2	a3	k1
9,49792728	-0,08	0,5	0,085	-2,38288617

f1 (Hz)	b1	b2	b3	k2
9,49792728	0,005	-0,06	-1,005	-1,12382252

d (person/m2)	B (m)	L (m)	kF	n	(σF)²
0,5	4	32	2,85E-04	64	1,82E-02

k1	k2	ξ	C	(σF)²	Generalized mass (kg)	(σa)²
-2,38288	-1,1238	0,004	6,8	1,82E-02	53187,2	-5,174E-08

If we take the absolute value of (σa)² we get the following:

$k_{a,95\%}$	(σa)²	$a_{max,95\%}$
3,77	5,17E-08	8,58E-04

5.2.1.3. Fully loaded with 1 person/m²

Vertical acceleration induced by fully loaded (1 person/m²)

Vertical modes for 1 person/m²

Mode	EI(vert)		L(m)	fn (Analytic) Hz
1	1,1232E+1 0	3464,2	32	2,7621811
2	1,1232E+1 0	3464,2	32	11,0487244
3	1,1232E+1 0	3464,2	32	24,8596299

f1 (Hz)	a1	a2	a3	k1
2,7621811	-0,07	0,56	0,084	1,09674631

f1 (Hz)	b1	b2	b3	k2
2,7621811	0,004	-0,045	-1	- 1,0937795 7

d (person/m ²)	B (m)	L (m)	kF	n	(σ _F) ²
1	4	32	7,00E- 03	128	8,96E-01

k1	k2	ξ	C	$(\sigma_F)^2$	Generalize d mass (kg)	$(\sigma_a)^2$
1,0967463	-1,09377	0,004	3,7	8,96E-01	55427,2	4,9658E-07

$k_{a,95\%}$	$(\sigma_a)^2$	$a_{max,95\%}$
3,8	4,97E-07	2,68E-03

Horizontal acceleration induced by fully loaded (1 person/m²)

Horizontal modes for 1 person/m²

Mode	EI(horiz)		L(m)	fn (Analytic) Hz
1	1,27E+11	3464,2	32	9,3040264
2	1,27E+11	3464,2	32	37,2161056
3	1,27E+11	3464,2	32	83,7362376

f1 (Hz)	a1	a2	a3	k1
9,3040264	-0,08	0,44	0,096	-2,7354209

f1 (Hz)	b1	b2	b3	k2
9,3040264	0,007	-0,071	-1	-1,054631

d (person/m2)	B (m)	L (m)	kF	n	$(\sigma_F)^2$
1	4	32	2,85E-04	128	3,65E-02

k1	k2	ξ	C	$(\sigma_F)^2$	Generalized mass (kg)	$(\sigma_a)^2$
-2,735420	-1,054631	0,004	7,9	3,65E-02	55427,2	-8,6737E-08

for absolute value of $(\sigma_a)^2$

$k_{a,95\%}$	$(\sigma_a)^2$	$a_{max,95\%}$
3,73	8,67E-08	1,10E-03

Setra guideline [1]

$$\text{Acceleration}_{\max} = \frac{1}{2} \frac{4F}{\xi_n \pi \rho S}$$

F = Fs*lp
lp = 4 m

Where:

F = load

Fs = load /unit area

lp = width

F = Fs*lp

Fs is defined below

Case1 : sparse crowd

Direction	Load per m ²
Vertical (v)	$d \times (280N) \times \cos(2\pi fvt) \times 10.8 \times (\xi/n)^{1/2} \times \psi$
Longitudinal (l)	$d \times (140N) \times \cos(2\pi fvt) \times 10.8 \times (\xi/n)^{1/2} \times \psi$
Transversal (t)	$d \times (35N) \times \cos(2\pi fvt) \times 10.8 \times (\xi/n)^{1/2} \times \psi$

Case 2: very dense crowd

Direction	Load per m ²
Vertical (v)	$1.0 \times (280N) \times \cos(2\pi fvt) \times 1.85 (1/n)^{1/2} \times \psi$
Longitudinal (l)	$1.0 \times (140N) \times \cos(2\pi fvt) \times 1.85 (1/n)^{1/2} \times \psi$
Transversal (t)	$1.0 \times (35N) \times \cos(2\pi fvt) \times 1.85 (1/n)^{1/2} \times \psi$

Setra Guideline [1] Accelerations Results

2 persons

Accel (Vert,max)	Accel (hor,max)
0,421887727	0,052735966

0,5 persons/m2

Accel (Vert,max)	Accel (hor,max)
2,289205484	0,286150685

4 persons

Accel (Vert,max)	Accel (hor,max)
0,595817168	0,074477146

1 person/m2

Accel (Vert,max)	Accel (hor,max)
8,413989011	1,051748626

These guideline [1] shows **8,413989011m/sec²** vertical acceleration but the reduction factor (Ψ) = 0. We can take the results from other guideline; JRC [2] to compare against FEM results.

5.3. Method 2: Dynamic (FEM)

This method is used by FEM programme (SAP2000). The cosine function in in this programme is applied. The guideline [1] gives following:

5.3.1. Case 1: Sparse and dense crowds

$$F_v = d \times 280 \times \text{Cos}(2\pi f_v t) \times 10.8 \times (\xi/n)^{1/2} \times \Psi$$

$$F_l = d \times 140 \times \text{Cos}(2\pi f_v t) \times 10.8 \times (\xi/n)^{1/2} \times \Psi$$

$$F_t = d \times 35 \times \text{Cos}(2\pi f_v t) \times 10.8 \times (\xi/n)^{1/2} \times \Psi$$

Where:

$$n = S \cdot d$$

n = number of pedestrians on the bridge.

S = usable area.

d = density of pedestrians/m²

ξ = 0,004 (damping coefficient)

$\Psi = 1$ (the worst case)

Above all values are in N/mm^2

In short equation:

$$F_v = 45,785N \times \text{Cos}(2\pi f_v t) \times \Psi$$

$$F_l = 22,89N \times \text{Cos}(2\pi f_v t) \times \Psi$$

$$F_t = 5,72N \times \text{Cos}(2\pi f_v t) \times \Psi$$

5.3.2. Case 2: Very dense crowd

$$F_v = 1.0 \times 280 \times \text{Cos}(2\pi f_v t) \times 1.85 \times (1/n)^{1/2} \times \Psi$$

$$F_l = 1.0 \times 140 \times \text{Cos}(2\pi f_v t) \times 1.85 \times (1/n)^{1/2} \times \Psi$$

$$F_t = 1.0 \times 35 \times \text{Cos}(2\pi f_v t) \times 1.85 \times (1/n)^{1/2} \times \Psi$$

Where:

$$n = S \cdot d$$

$\Psi = 1$ (reduction factor: the worst case)

Above all values are in N/mm^2

In short equation:

$$F_t = 11,9534N \times \text{Cos}(2\pi f_v t) \times \Psi$$

$$F_l = 5,977N \times \text{Cos}(2\pi f_v t) \times \Psi$$

$$F_t = 1,494N \times \text{Cos}(2\pi f_v t) \times \Psi$$

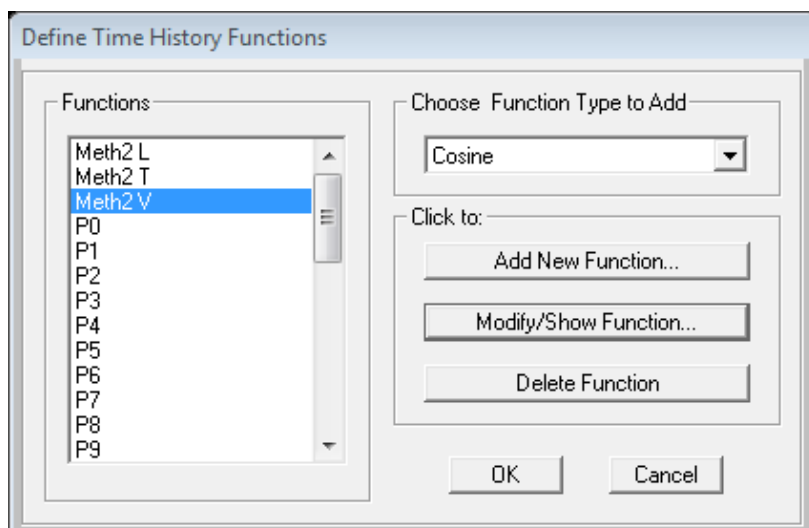

Figure 5.3.2.1 Time History Functions

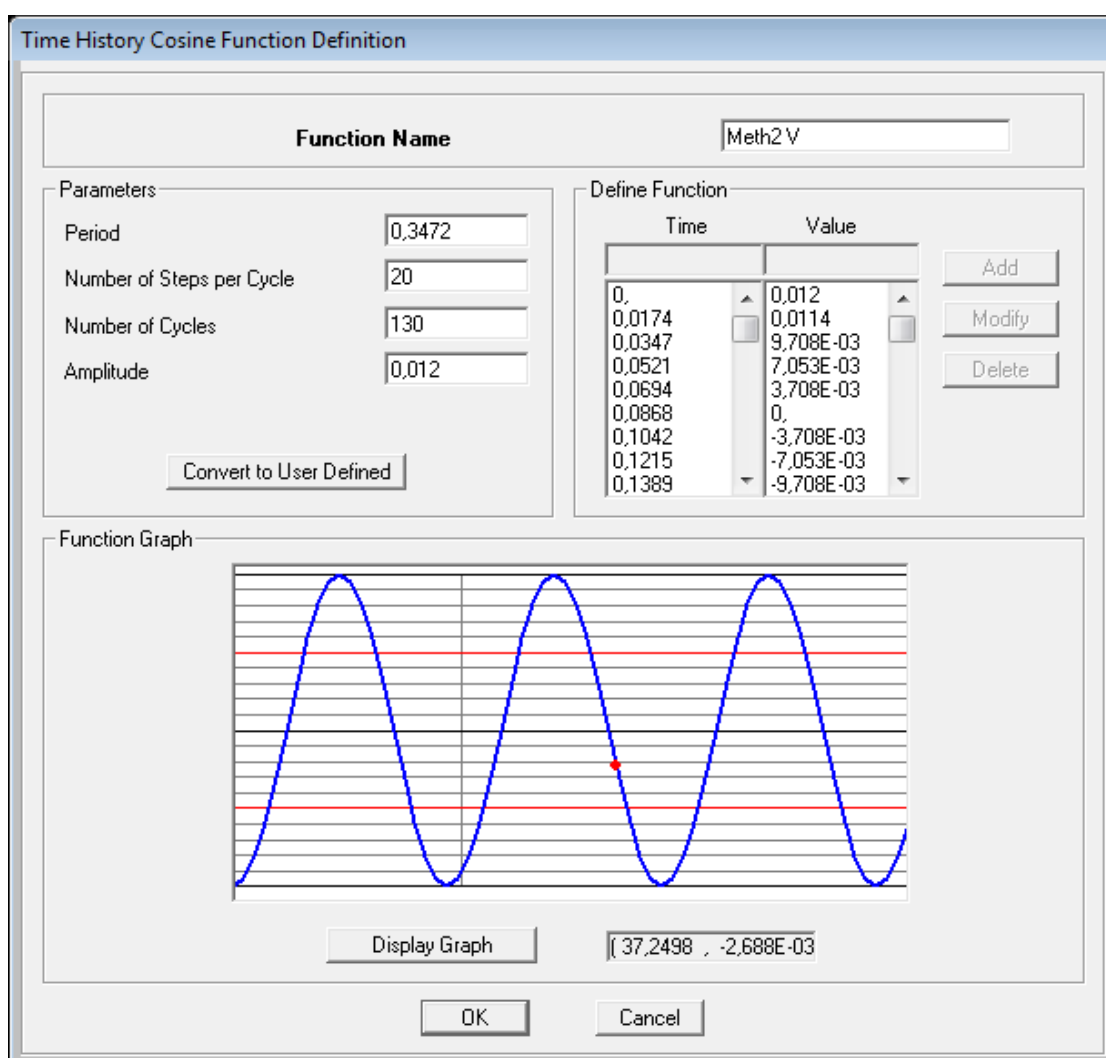

Figure 5.3.2.2 Time History Functions (Cosine function)

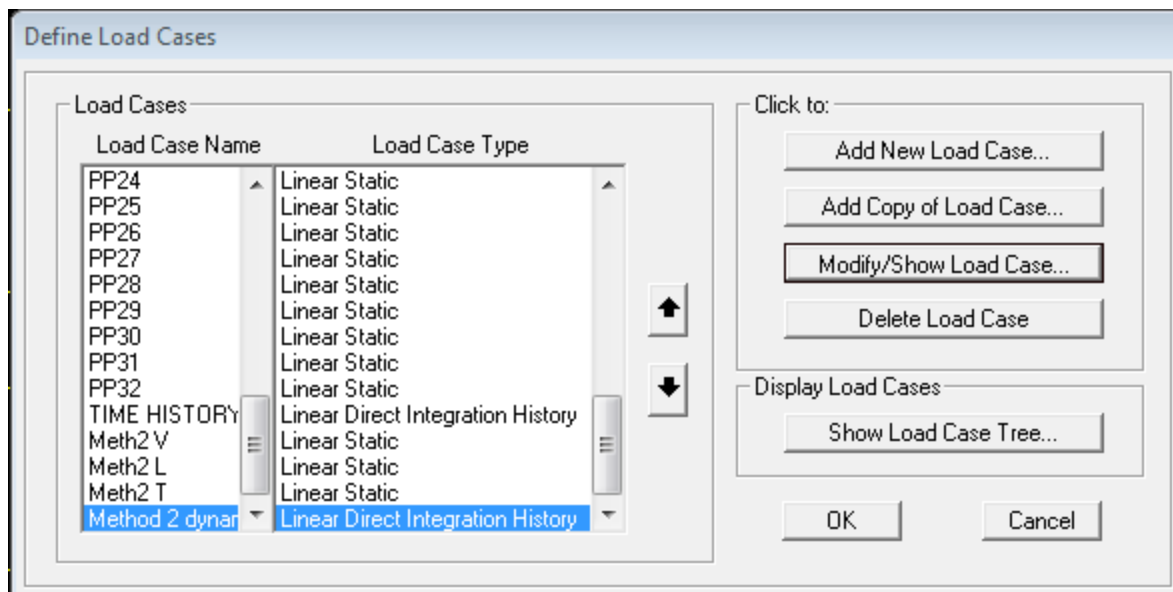

Figure 5.3.2.3 Defining Load Case

Load Case Data - Linear Modal History

Load Case Name: Notes: Load Case Type:

Initial Conditions: Zero Initial Conditions - Start from Unstressed State
 Continue from State at End of Modal History
Important Note: Loads from this previous case are included in the current case

Modal Load Case: Use Modes from Case

Loads Applied:

Load Type	Load Name	Function	Scale Factor
<input type="text" value="Load Pattern"/>	<input type="text" value="Meth2 V"/>	<input type="text" value="Meth2 V"/>	<input type="text" value="1."/>
<input type="text" value="Load Pattern"/>	<input type="text" value="Meth2 L"/>	<input type="text" value="Meth2 L"/>	<input type="text" value="1."/>
<input type="text" value="Load Pattern"/>	<input type="text" value="Meth2 T"/>	<input type="text" value="Meth2 T"/>	<input type="text" value="1."/>

Show Advanced Load Parameters

Time Step Data: Number of Output Time Steps
Output Time Step Size

Other Parameters: Modal Damping

Figure 5.3.2.4 Load Case Data Linear: Modal Analysis

Load Case Data - Linear Direct Integration History

Load Case Name: Notes: Load Case Type:

Stiffness to Use: Zero Initial Conditions - Unstressed State Stiffness at End of Nonlinear Case
 Important Note: Loads from the Nonlinear Case are NOT included in the current case

Modal Load Case:

Analysis Type: Linear Nonlinear Time History Type: Modal Direct Integration

Time History Motion Type: Transient Periodic

Loads Applied

Load Type	Load Name	Function	Scale Factor
<input type="text" value="Load Pattern"/> <input type="button" value="v"/>	<input type="text" value="Meth2 V"/> <input type="button" value="v"/>	<input type="text" value="Meth2 V"/> <input type="button" value="v"/>	<input type="text" value="1."/>
<input type="text" value="Load Pattern"/>	<input type="text" value="Meth2 L"/>	<input type="text" value="Meth2 L"/>	<input type="text" value="1."/>
<input type="text" value="Load Pattern"/>	<input type="text" value="Meth2 T"/>	<input type="text" value="Meth2 T"/>	<input type="text" value="1."/>

Show Advanced Load Parameters

Time Step Data

Number of Output Time Steps:

Output Time Step Size:

Other Parameters

Damping:

Time Integration:

Figure 5.3.2.5 Load Case Data Linear Direct Integration History

5.4. Method 3: Unconventional Time History created

Method 3 is an unconventional Time History created and modelled based on average pedestrian step frequency (2 Hz.) and 70 Kg/pedestrian. It is inconvenient to display huge documents of Excel here, but some graphs can be displayed below. Huge documents will be saved as CD (attachment).

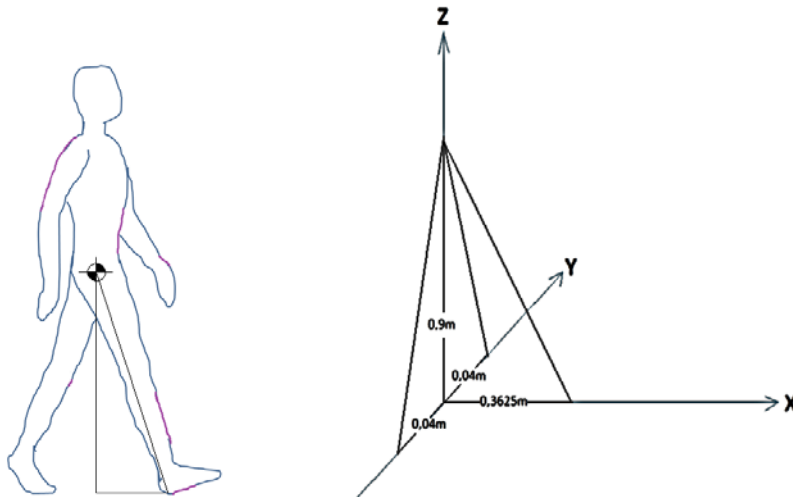

In simple geometry this gives us 70 Kg in vertical (Z), 28 Kg in longitudinal (X) and 3 Kg in transversal (Y) alternatively i.e. right (+Y) and left (-Y).

Time History is divided into 2 parts:

Part 1: A group of pedestrians walking on the bridge from start to end: in this case we take two groups i.e. a group of 2 persons and a group of 4 persons.

Part 2: Flow of pedestrians gradually increasing until the first row reach the end i.e. fully loaded, and then reducing the number of pedestrians as row after row pass/leave the end of the bridge. In this case we have two cases:

1st case has its highest number of pedestrians as 0,5 person/m², that means each row is 2 persons with 1 meter between rows.

2nd case: 4 persons/row which gives its highest as 1 person/m².

5.4.1. Part 1: A group of pedestrians

Some examples of Time History graphs for groups of pedestrians

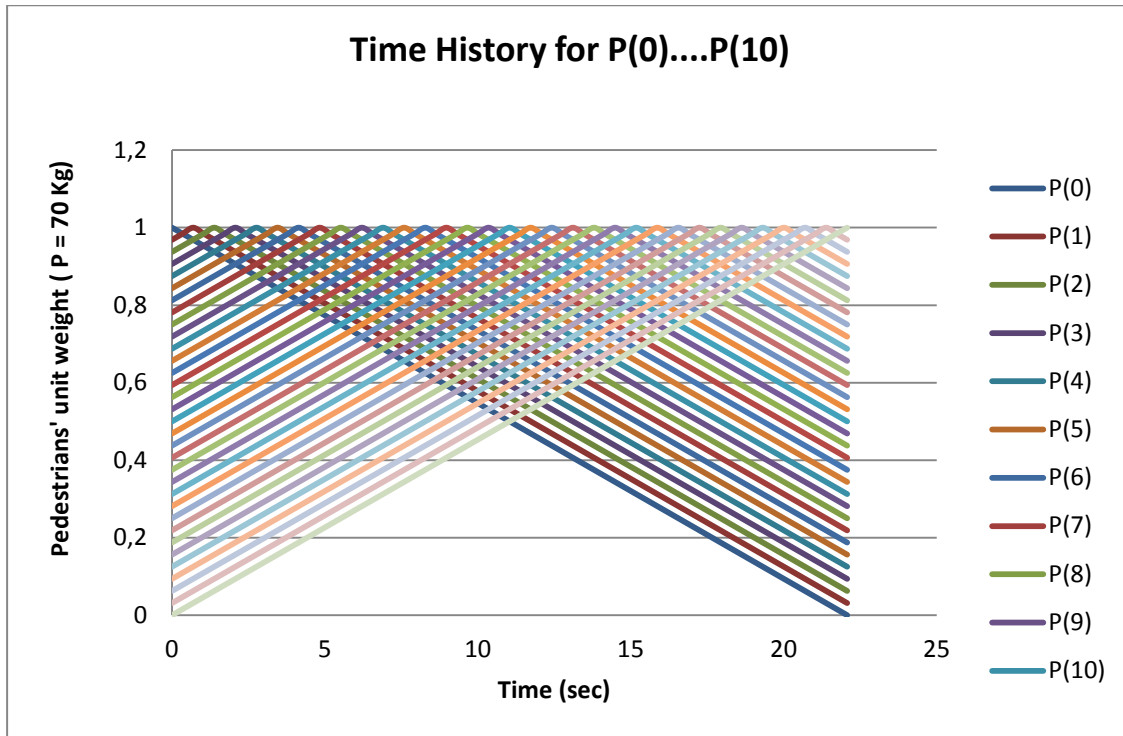

Time history for P(0), P(1), P(2)P(09) represent points on bridge i.e. P(4) is point at 4 meters from the start

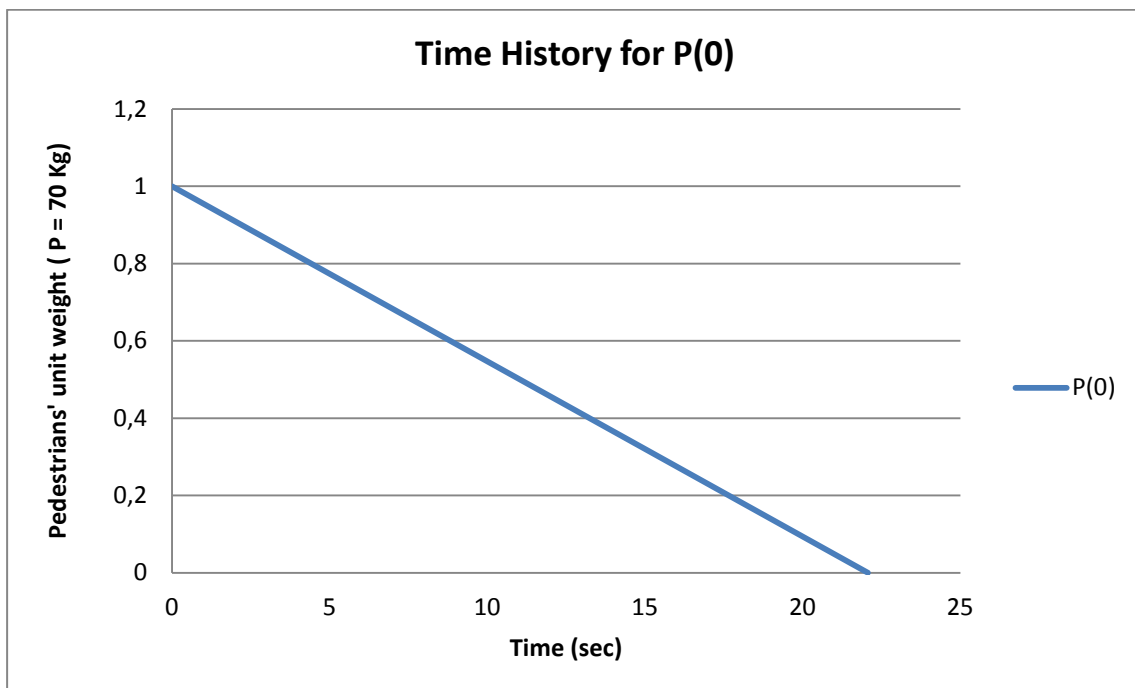

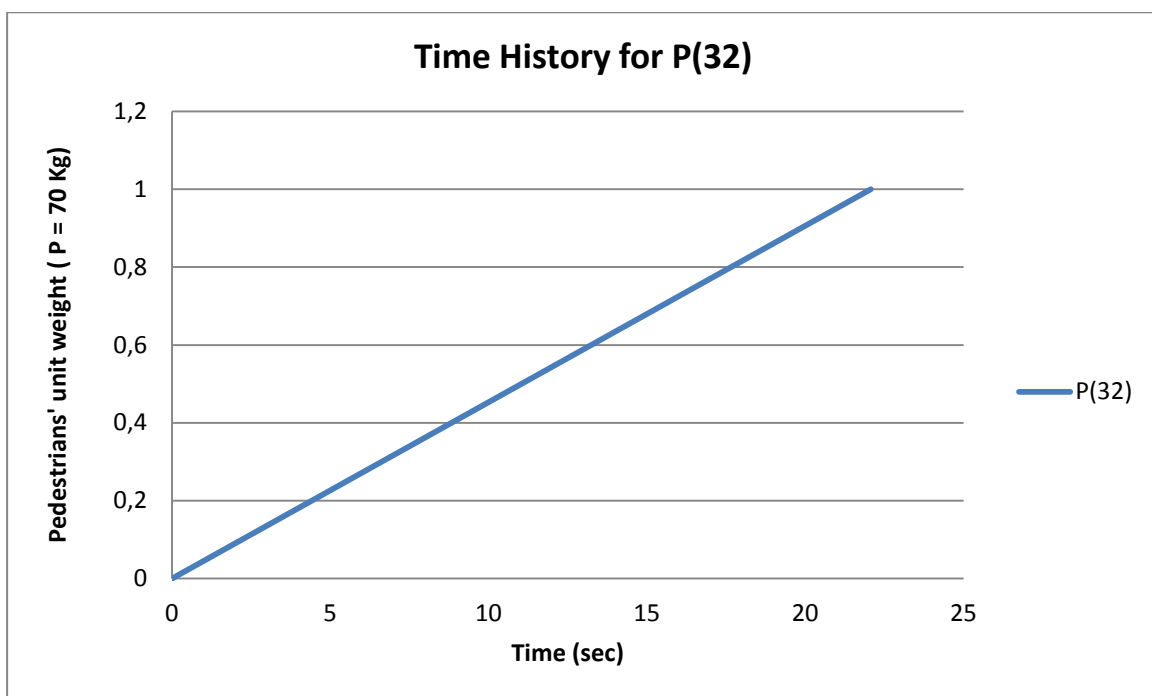
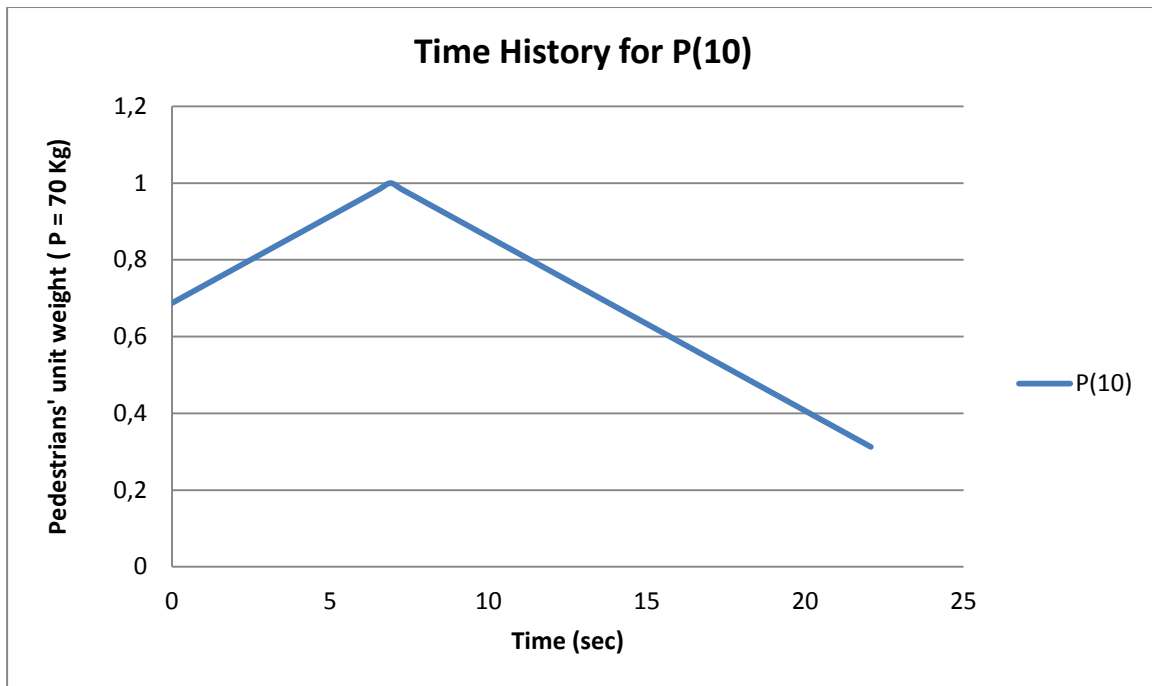

5.4.1. Part 2: Flow of pedestrians gradually increasing/decreasing

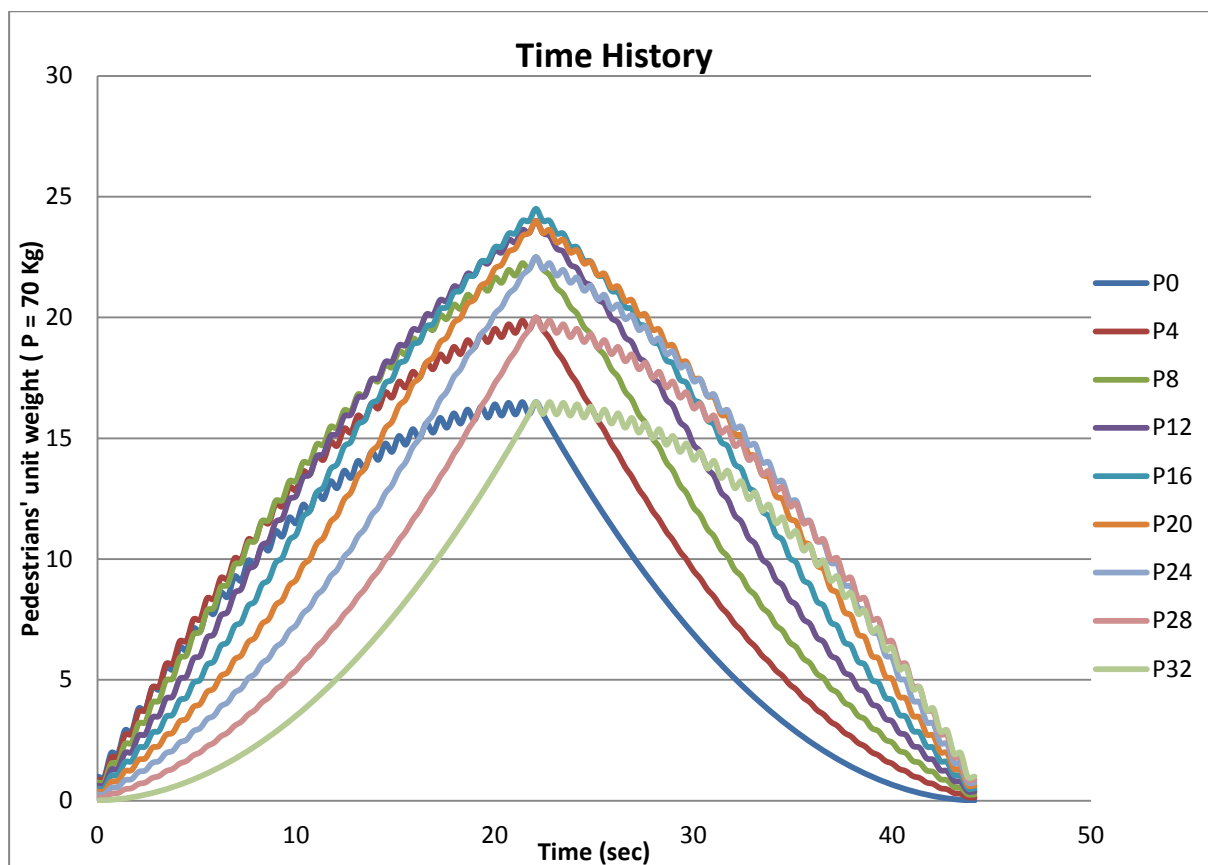

Time History of some points randomly selected to see the how it changes; it can be complicated to represent all points in one graph. P0, P4.....P32 represent points on bridge i.e. P4 is point at 4 meters from the start.

Graph shows increasing pedestrians until the first row reach the other end of the bridge at 22,068 sec, then gradual reduction begins until the last row pass the end at 44,13sec.

Below are showed graphs of different points Time History.

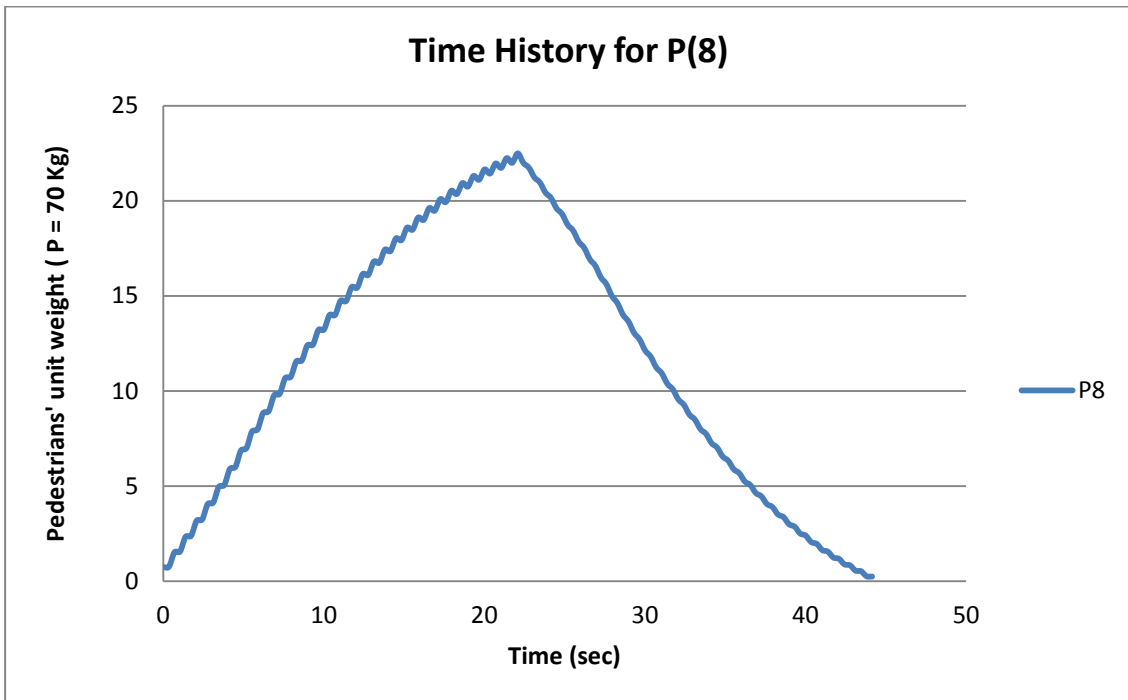
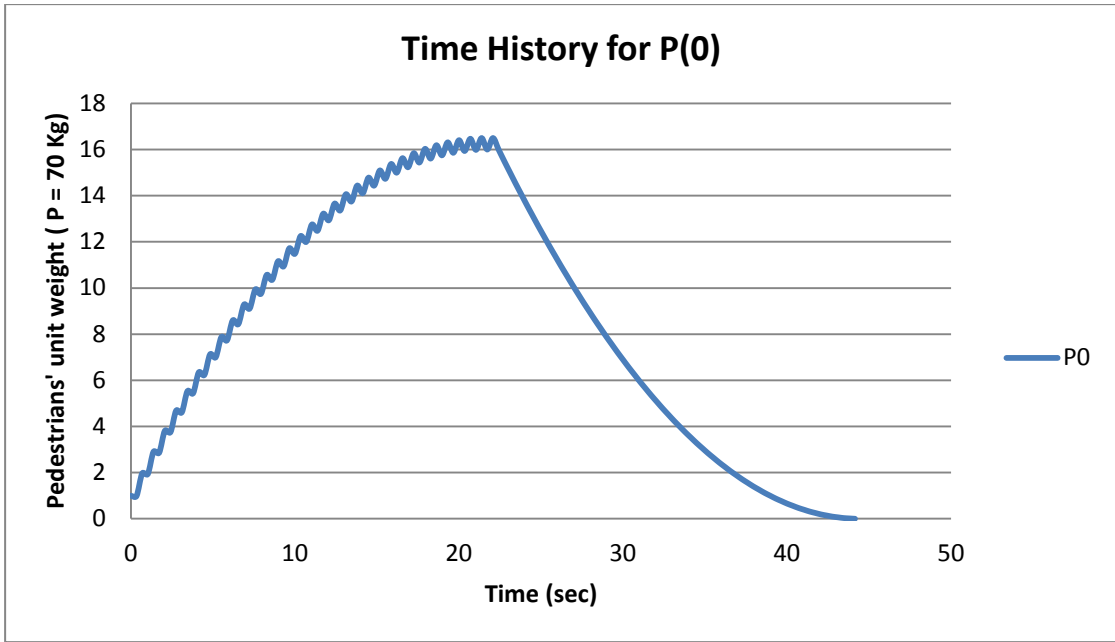

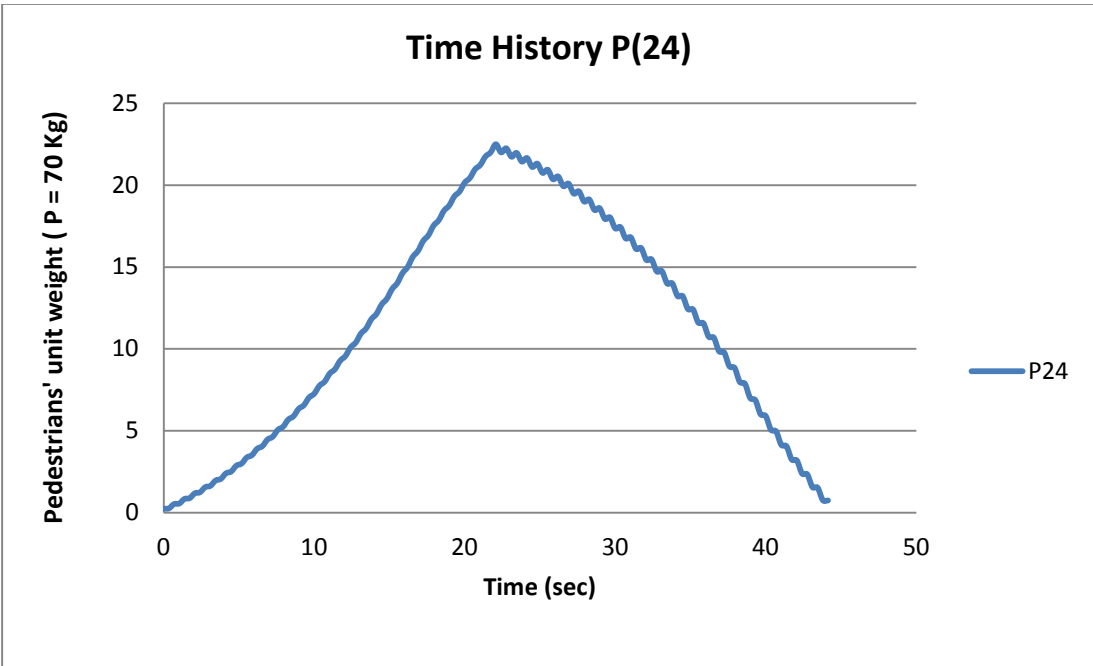
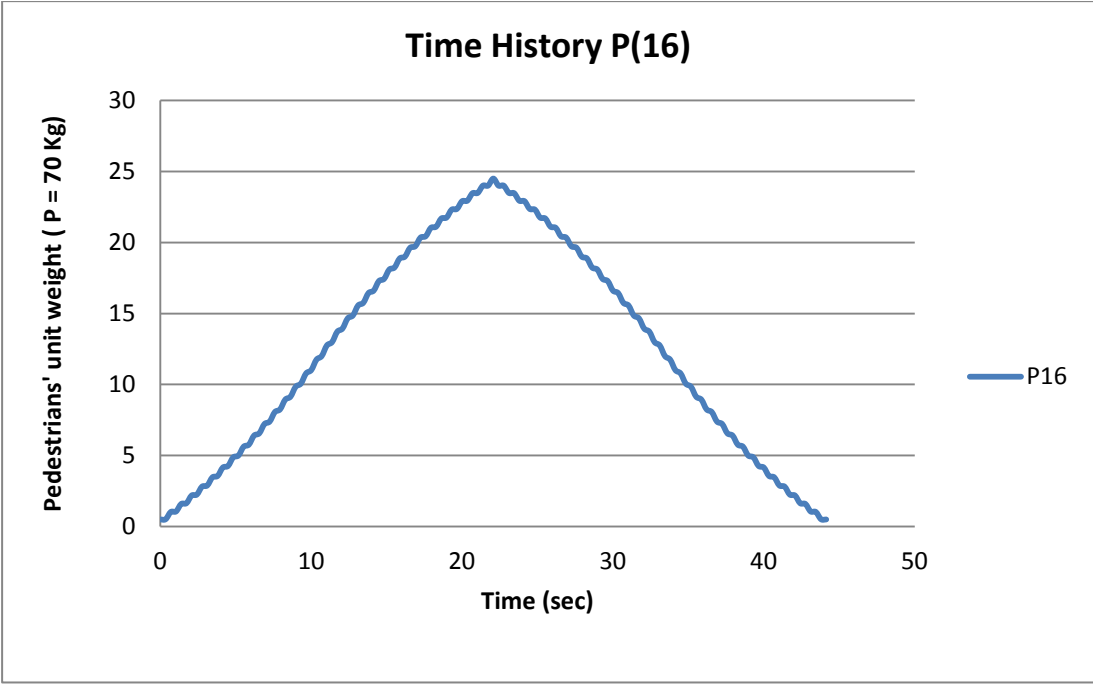

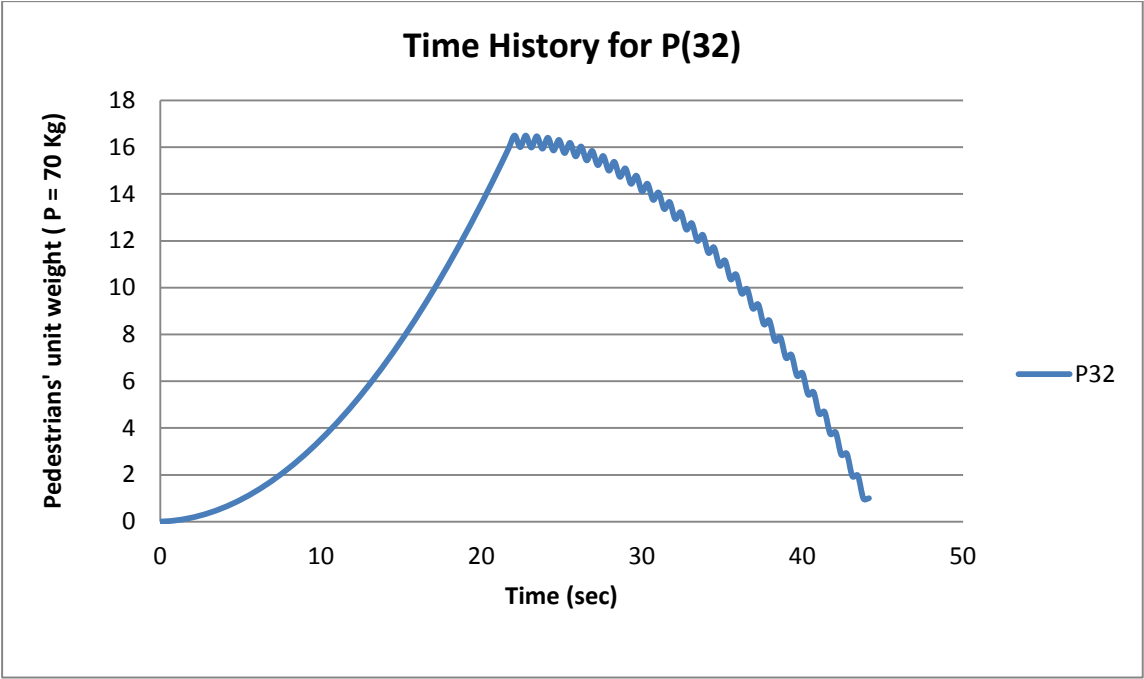

6. Results of FEM (SAP2000)

Method 2: (Dynamic) and Method 3: (Unconventional Time History) accelerations and Pseudo Spectral Acceleration results will be displayed in global coordinates' directions: X, Y and Z which means longitudinal, transversal/horizontal and vertical respectively.

10 maximum and 10 minimum accelerations are selected from each case in 3 directions (X,Y,Z). The joint which has highest absolute value is shown in the tables, acceleration graph and Pseudo Spectral acceleration at the same joint.

6.1. Method 2: Dynamic

In this method, pedestrian loads are modelled by using Cosine function in Time History Functions in SAP2000 as described on 5.3. (Method 2: Dynamic)

6.1.1. Acceleration results (SAP2000) of dynamic fully loaded (0,5 persons/m²) direct integration

Max. acceleration in X (longitudinal)		Min. acceleration in X (longitudinal)	
Joint	(m/s ²)	Joint	(m/s ²)
67	0,000351138	33	-0,00022894
206	0,0003386	31	-0,00022858
33	0,000338368	67	-0,00022763
65	0,000316373	65	-0,00022733
31	0,000303883	29	-0,0002251
205	0,000285701	63	-0,00022397
63	0,000266684	206	-0,0002239
29	0,000255122	205	-0,00022318
204	0,000239703	204	-0,0002195
224	0,000238733	27	-0,00021826

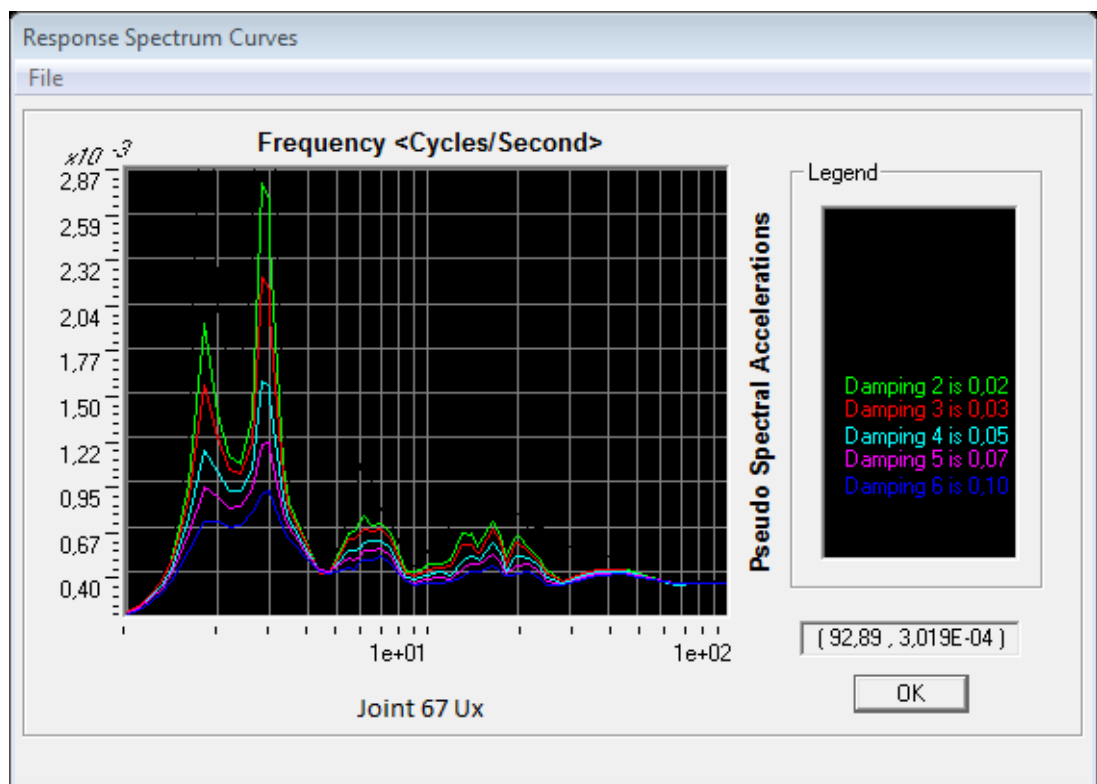
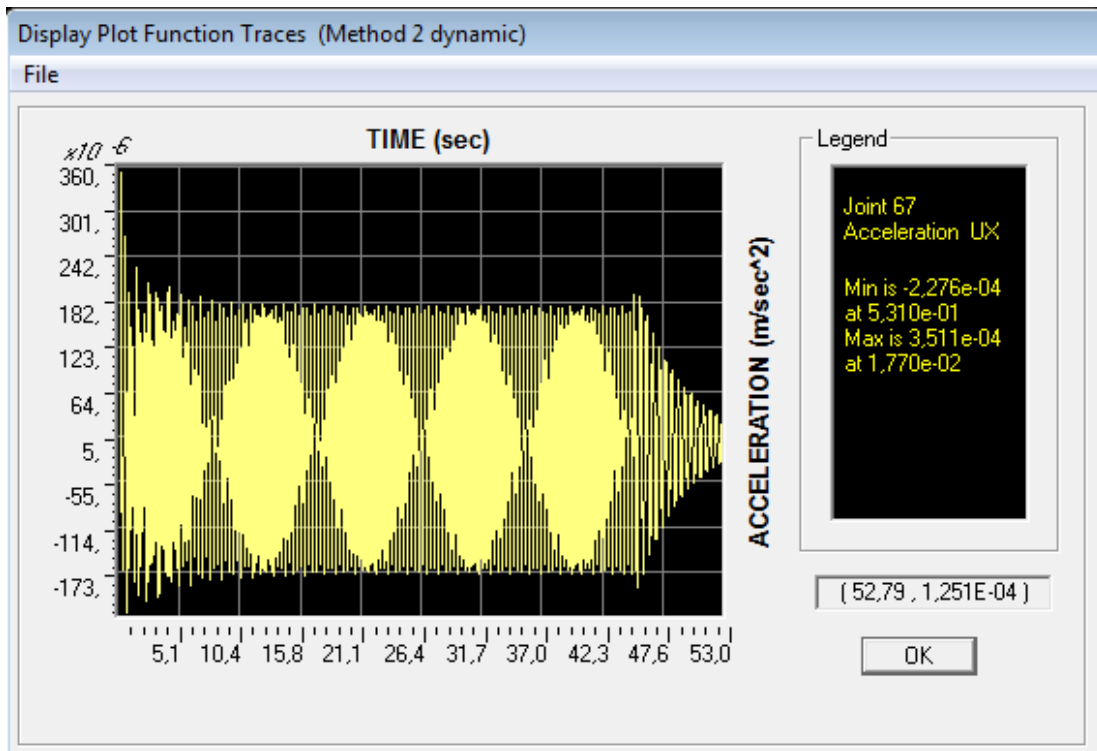

Max. acceleration in Y (horizontal)		Min. acceleration in Y (horizontal)	
Joint	(m/s ²)	Joint	(m/s ²)
17	0,000030887	17	-0,000039812
29	0,000030414	19	-0,000038772
25	0,000030100	15	-0,000037821
5	0,000029857	21	-0,000034337
250	0,000029743	250	-0,000032781
19	0,000029731	199	-0,000032708
21	0,000029428	13	-0,000032611
27	0,000029401	217	-0,000032584
15	0,000029399	200	-0,000032468
251	0,000029209	216	-0,000032318

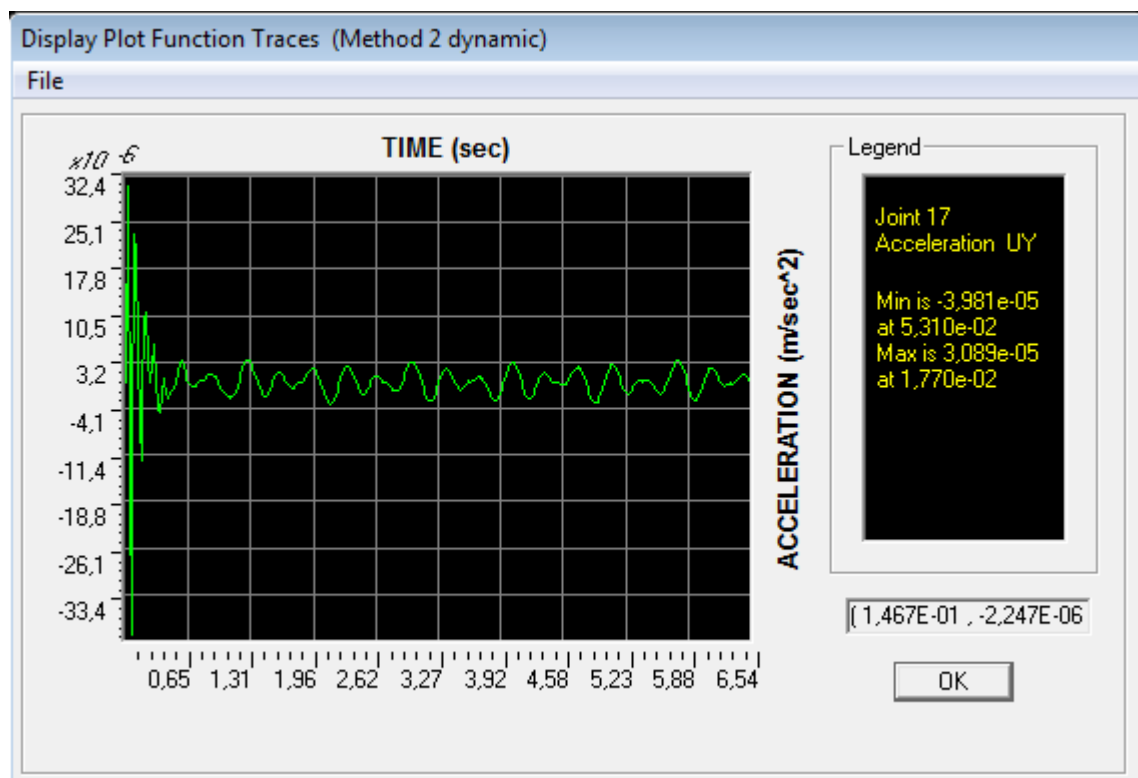

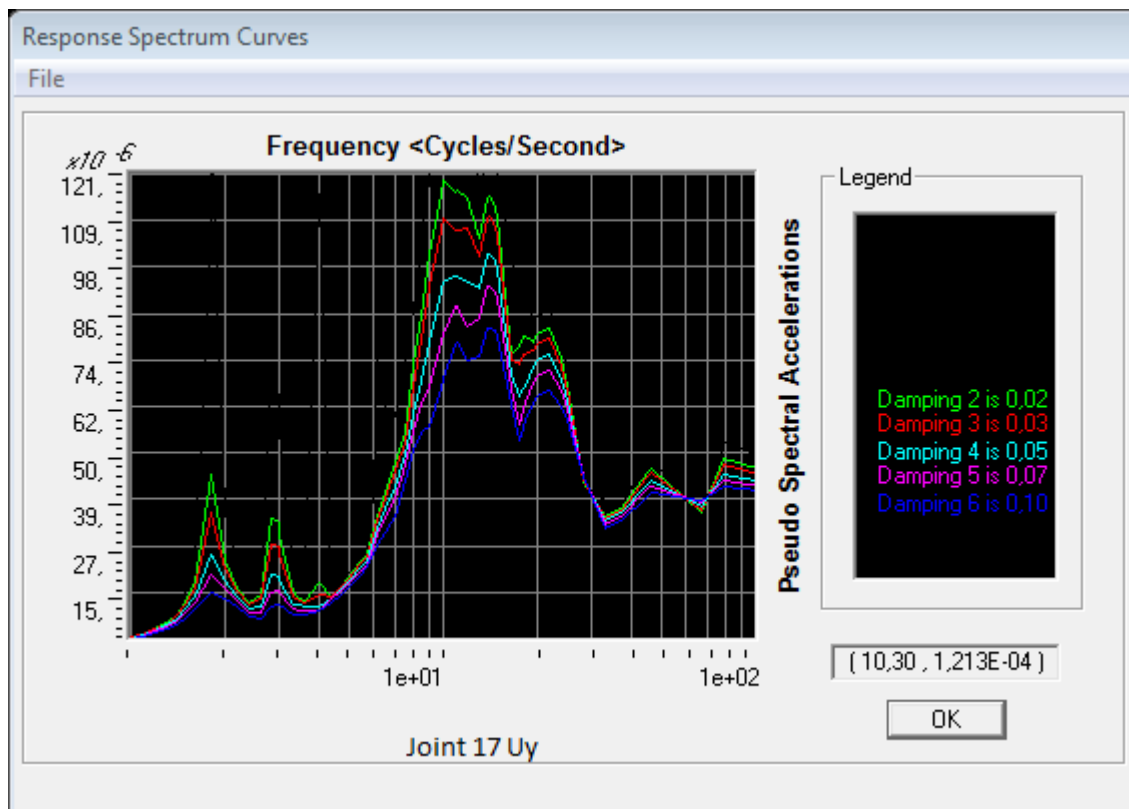

Max. acceleration in Z (vertical)		Min. acceleration in Z (vertical)	
Joint	(m/s ²)	Joint	(m/s ²)
51	0,017502161	17	-0,01611051
17	0,01750029	51	-0,01610883
216	0,017460226	250	-0,0160718
250	0,017458518	216	-0,01607025
199	0,017389134	199	-0,01602658
53	0,016837582	19	-0,01559288
19	0,01683604	53	-0,01559111
49	0,016835134	15	-0,01558666
15	0,016833058	49	-0,01558512
217	0,016797263	251	-0,01555505

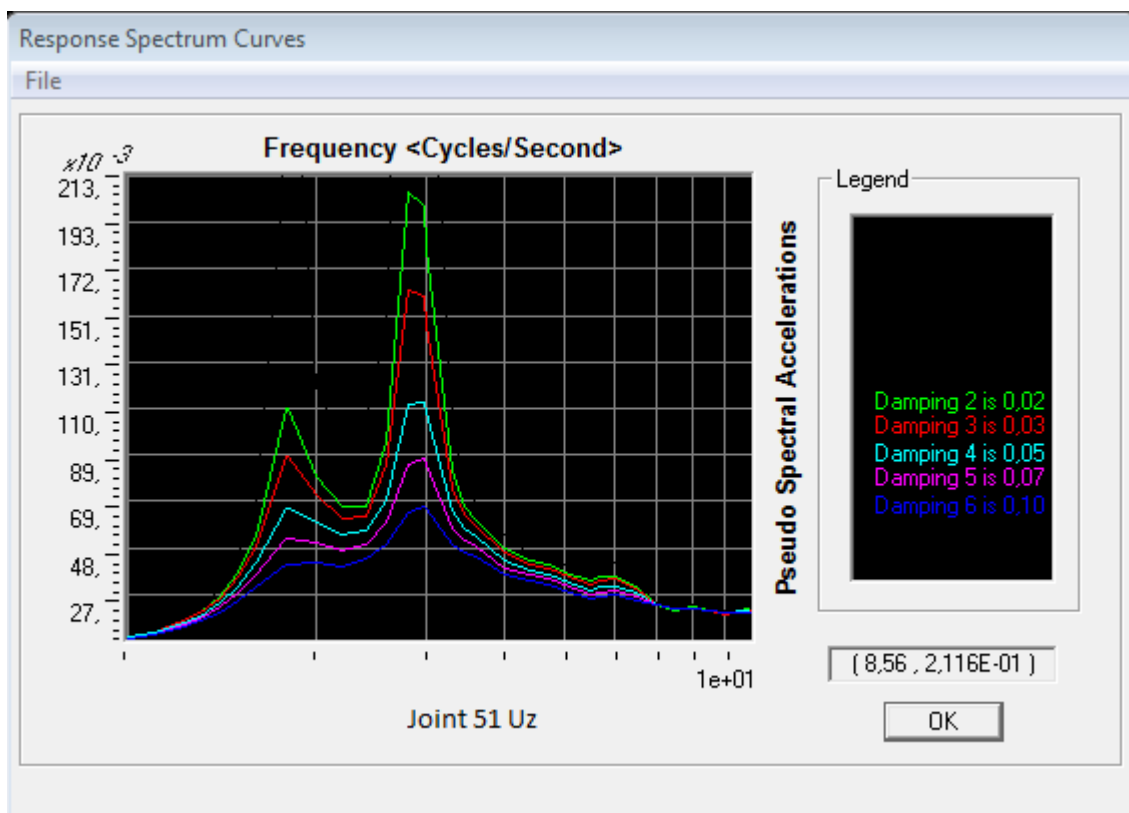
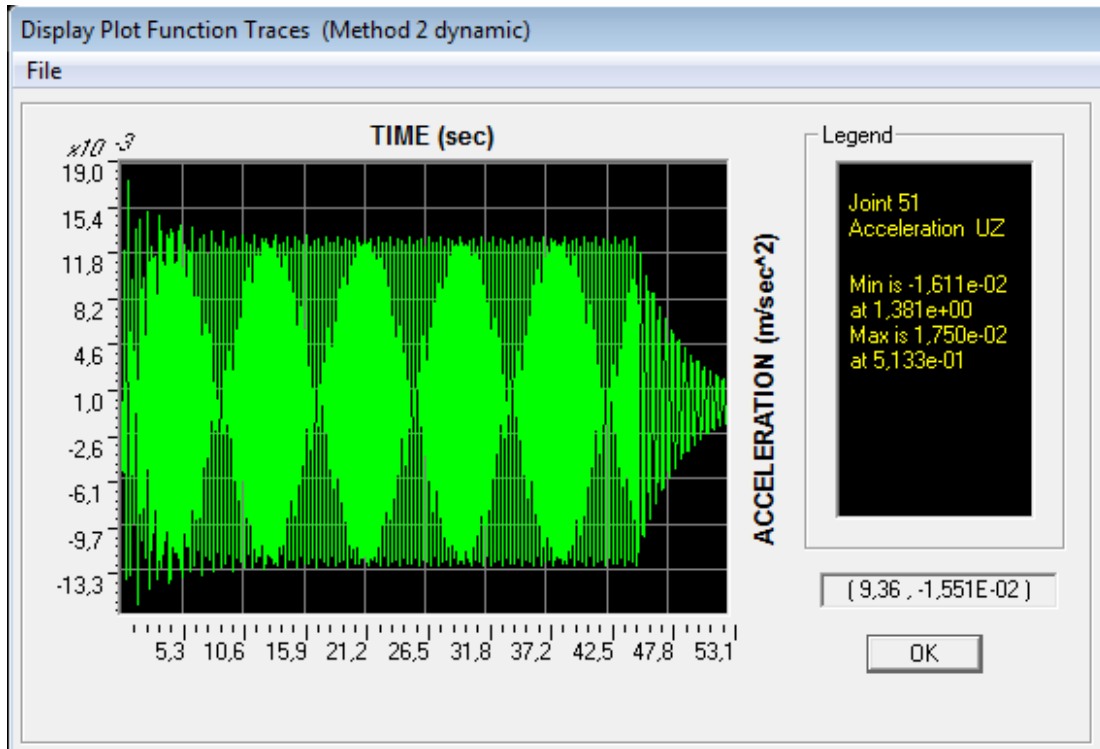

6.1.2. Acceleration results (SAP2000) of dynamic fully loaded (0,5 persons/m²) modal (Ritz vector)

Max. acceleration in X (longitudinal)		Min. acceleration in X (longitudinal)	
Joint	(m/s ²)	Joint	(m/s ²)
205	0,00070359	207	-0,00074148
206	0,00067535	31	-0,00058652
198	0,00062068	33	-0,00058013
193	0,00060622	65	-0,00057302
207	0,00059683	206	-0,00056992
192	0,00058962	67	-0,0005676
197	0,00057541	205	-0,00055844
204	0,00056695	29	-0,00055443
194	0,00055421	63	-0,0005403
195	0,0004986	204	-0,00052651

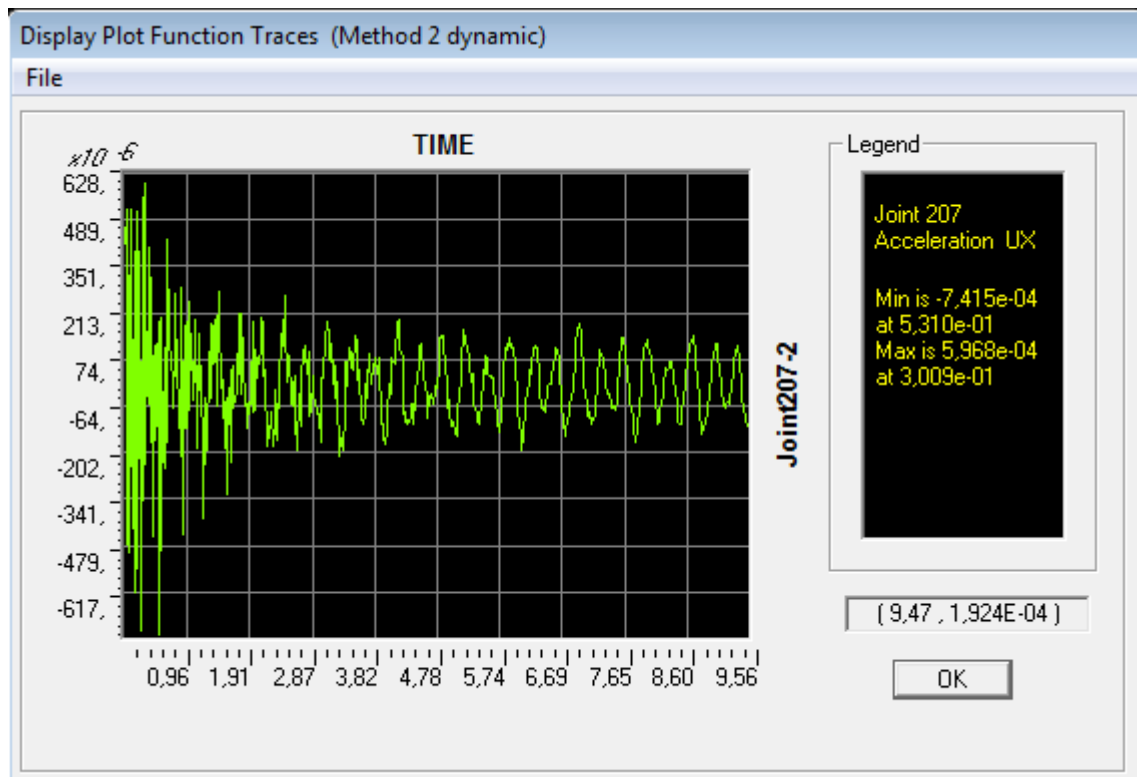

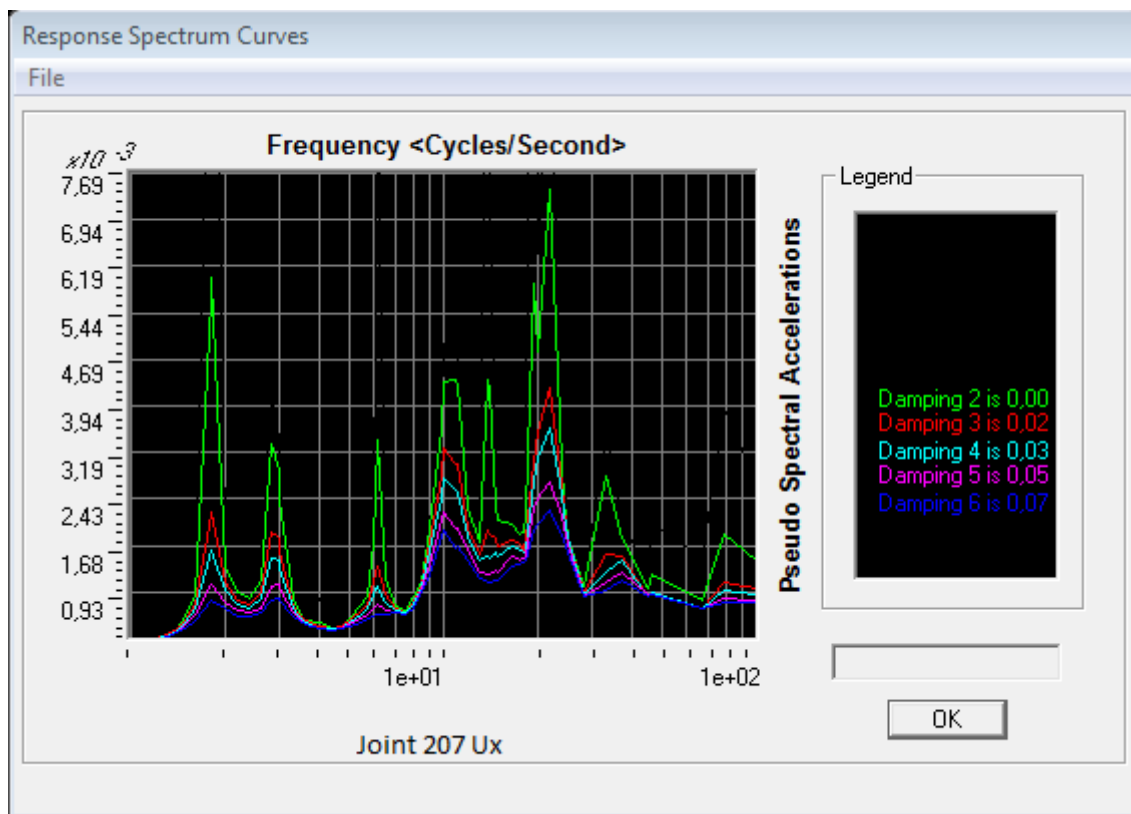

Max. acceleration in Y (horizontal)		Min. acceleration in Y (horizontal)	
Joint	(m/s ²)	Joint	(m/s ²)
13	0,00074222	55	-0,00066085
21	0,00073832	47	-0,00066044
11	0,00070345	57	-0,00062168
23	0,0006991	45	-0,00062033
15	0,00069315	53	-0,00061427
19	0,00069167	49	-0,00061346
17	0,00059782	21	-0,00057445
55	0,00059511	13	-0,00057181
47	0,00059456	23	-0,00053918
57	0,00056074	11	-0,00053341

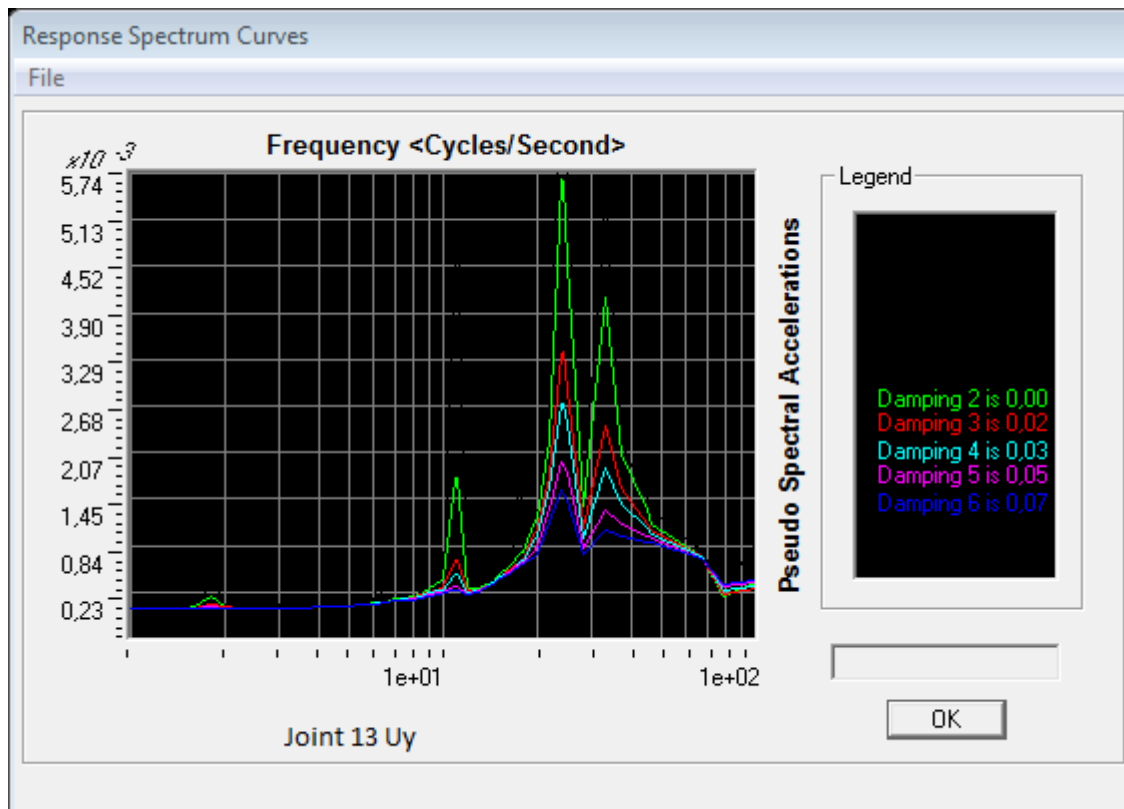
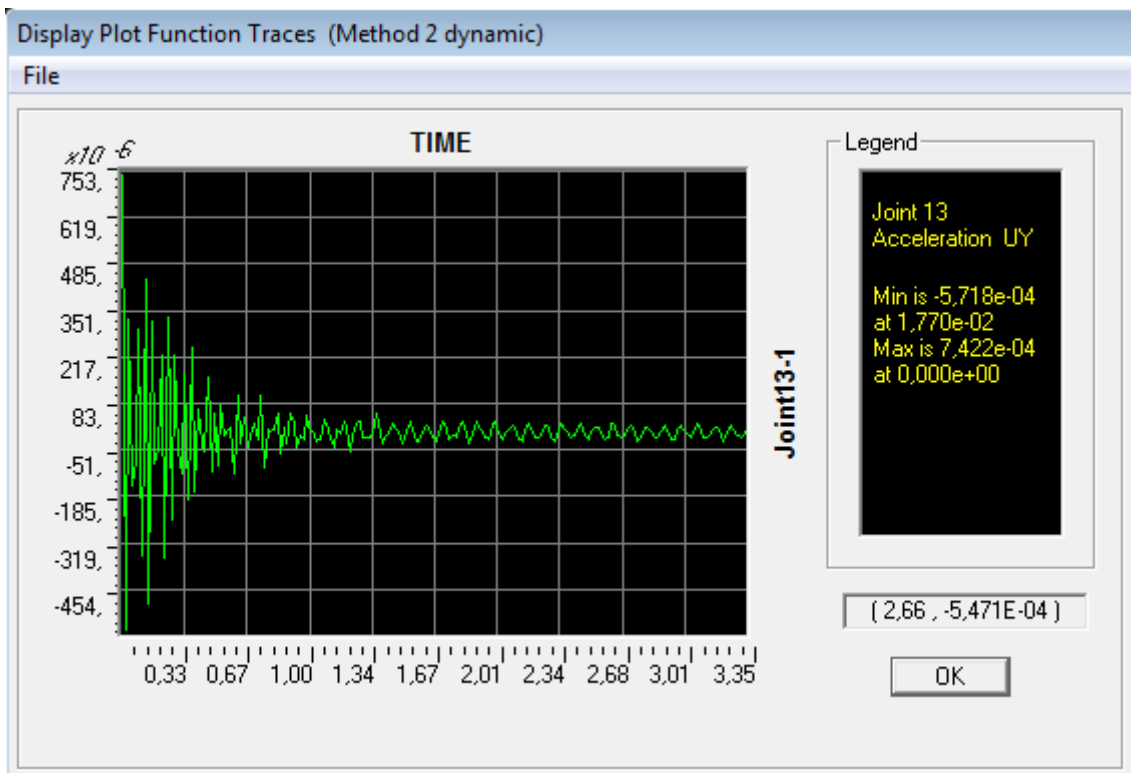

Max. acceleration in Z (vertical)		Min. acceleration in Z (vertical)	
Joint	(m/s ²)	Joint	(m/s ²)
17	0,01957858	199	-0,02117706
51	0,01955574	17	-0,02032972
250	0,0195088	51	-0,02032354
216	0,01948914	250	-0,02023254
199	0,01914819	216	-0,02022597
15	0,01819457	200	-0,01923146
19	0,01817351	198	-0,01912232
49	0,01816762	19	-0,01897286
53	0,01815455	53	-0,01896479
249	0,0181317	251	-0,0188705

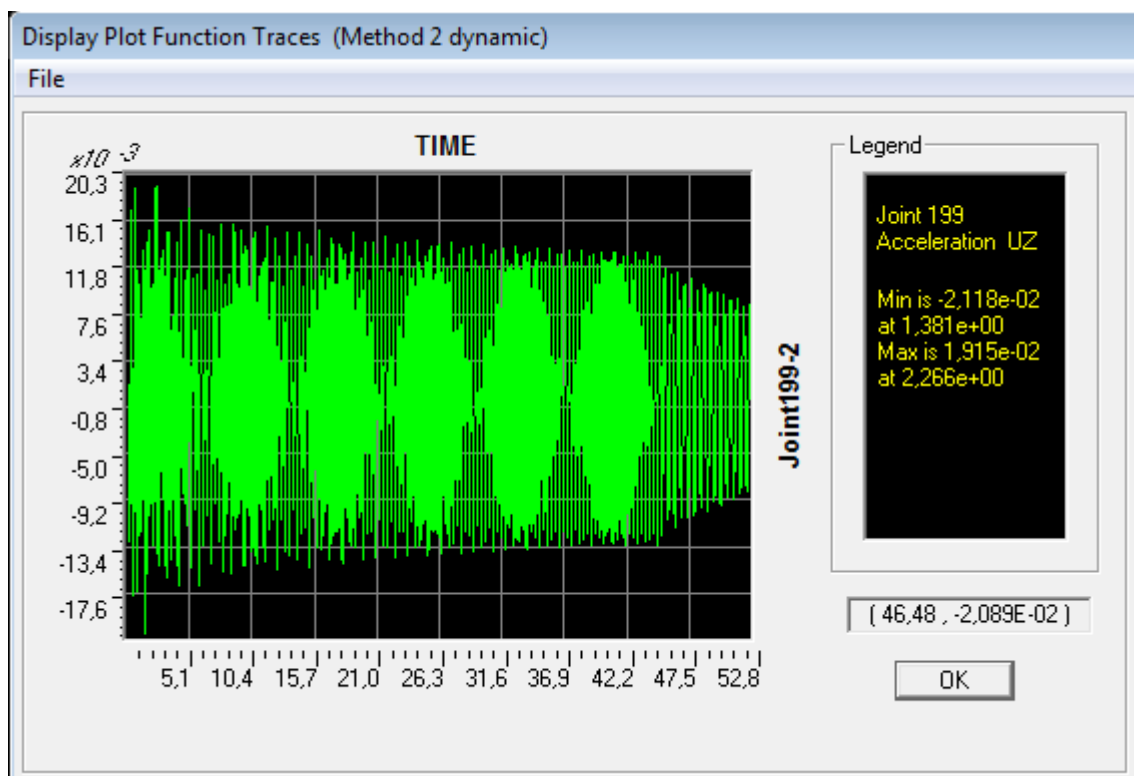

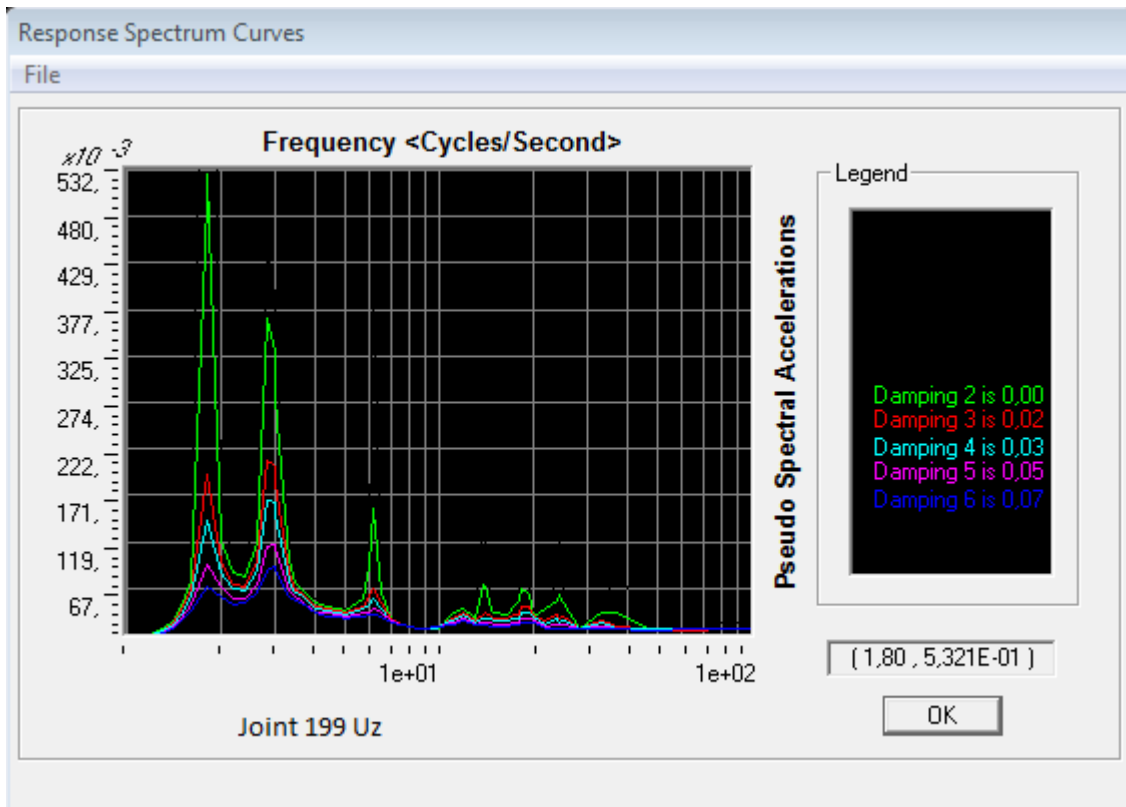

Modes for Time History: Dynamic fully loaded (1 persons/m²) direct integration

OutputCase	StepType	StepNum	Period	Frequency	CircFreq	Eigenvalue
MODAL	Mode	1	0,47346237	2,11210025	13,2707173	176,111937
MODAL	Mode	2	0,38799139	2,57737676	16,1941358	262,250034
MODAL	Mode	3	0,26138577	3,82576301	24,0379779	577,824382
MODAL	Mode	4	0,21177509	4,72199072	29,6691427	880,258028
MODAL	Mode	5	0,15764695	6,3432881	39,8560546	1588,50509
MODAL	Mode	6	0,10463197	9,55730793	60,0503367	3606,04294
MODAL	Mode	7	0,10453807	9,56589353	60,1042817	3612,52467
MODAL	Mode	8	0,09672025	10,339096	64,9624562	4220,12072
MODAL	Mode	9	0,07754682	12,895436	81,024414	6564,95567
MODAL	Mode	10	0,07093172	14,0980656	88,5807588	7846,55084
MODAL	Mode	11	0,06181572	16,1771136	101,643803	10331,4626
MODAL	Mode	12	0,05036634	19,854528	124,749679	15562,4823
MODAL	Mode	13	0,04929214	20,2872119	127,468312	16248,1705
MODAL	Mode	14	0,04702276	21,2662976	133,620088	17854,328
MODAL	Mode	15	0,03381255	29,5748179	185,824061	34530,5818
MODAL	Mode	16	0,0330964	30,2147653	189,84497	36041,1125
MODAL	Mode	17	0,02576352	38,8145764	243,879176	59477,0526
MODAL	Mode	18	0,01695985	58,9627937	370,474159	137251,102
MODAL	Mode	19	0,01612055	62,0326217	389,762457	151914,773
MODAL	Mode	20	0,00771497	129,618054	814,414255	663270,578

6.1.3. Acceleration results (SAP2000) of dynamic fully loaded (1 persons/m²) direct integration

Max. acceleration in X (longitudinal)		Min. acceleration in X (longitudinal)	
Joint	(m/s ²)	Joint	(m/s ²)
33	0,00555699	33	-0,00501753
67	0,00554052	67	-0,00500488
206	0,00551794	206	-0,0049859
31	0,00550485	31	-0,00497827
65	0,00548899	65	-0,00496621
205	0,00540723	205	-0,00489058
29	0,00533647	29	-0,00484238
63	0,00532208	63	-0,00483158
204	0,0052174	204	-0,00473679
27	0,00506663	27	-0,00461652

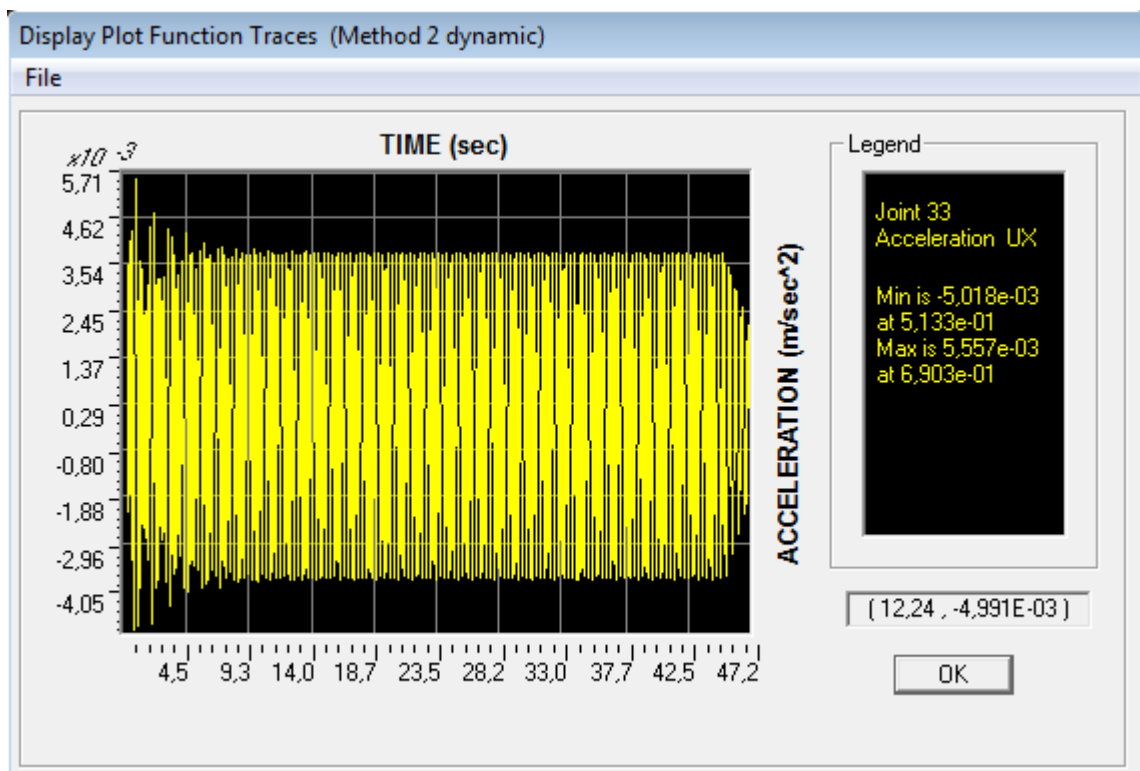

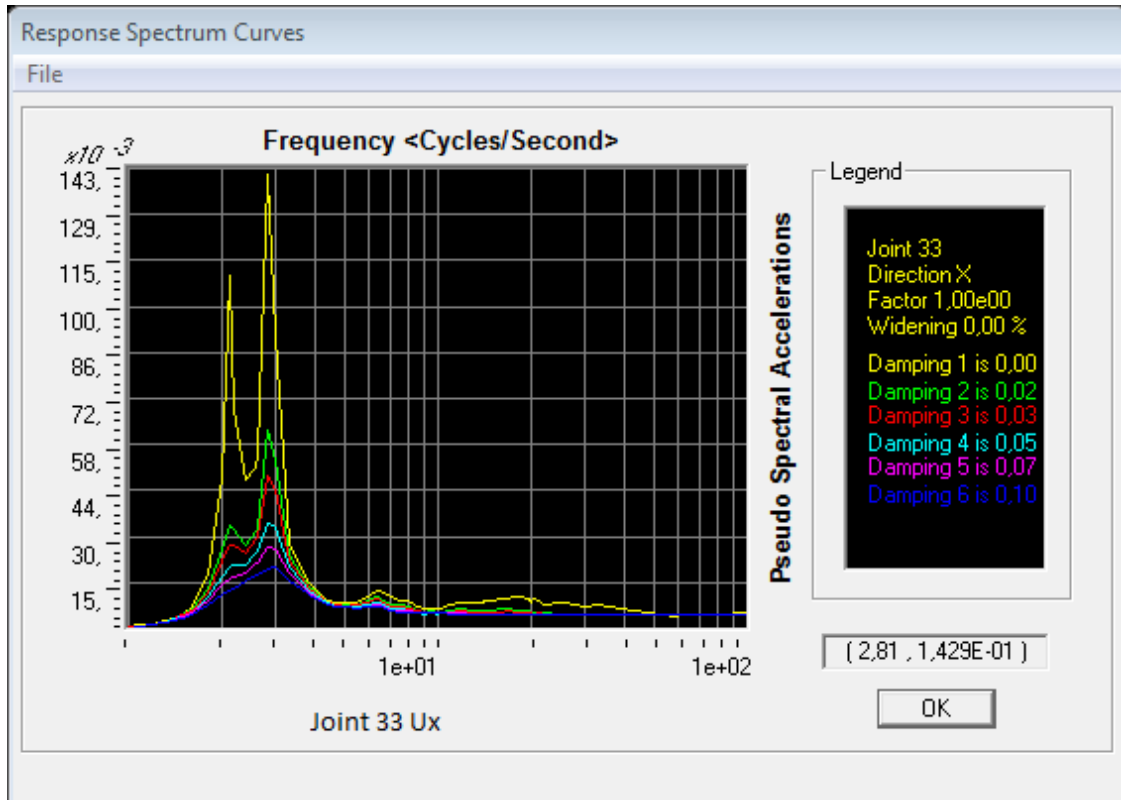

Max. acceleration in Y (horizontal)		Min. acceleration in Y (horizontal)	
Joint	(m/s ²)	Joint	(m/s ²)
25	0,00043603	19	-0,00044089
17	0,00043434	21	-0,00043704
21	0,000427	17	-0,00043672
19	0,00042586	15	-0,00041095
23	0,00041724	23	-0,00040297
15	0,00041454	13	-0,00038091
13	0,00040322	250	-0,00035354
27	0,00040097	251	-0,00034644
9	0,00039606	252	-0,0003423
11	0,0003816	25	-0,00034043

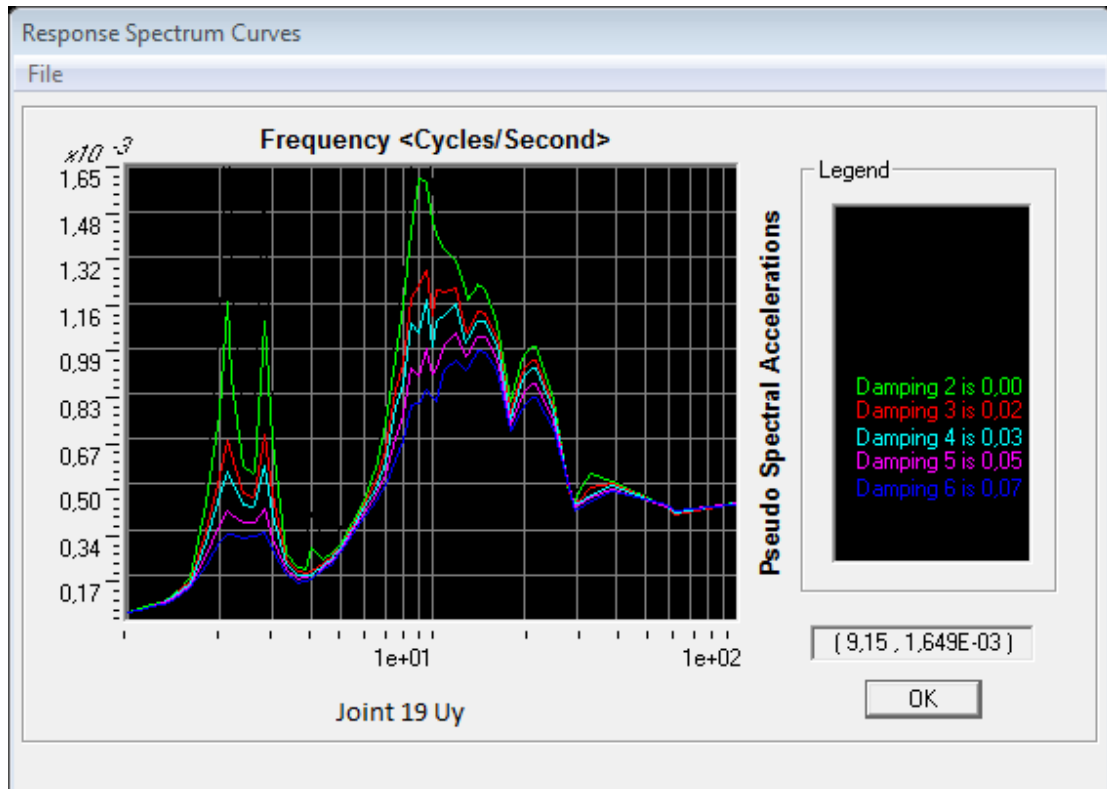
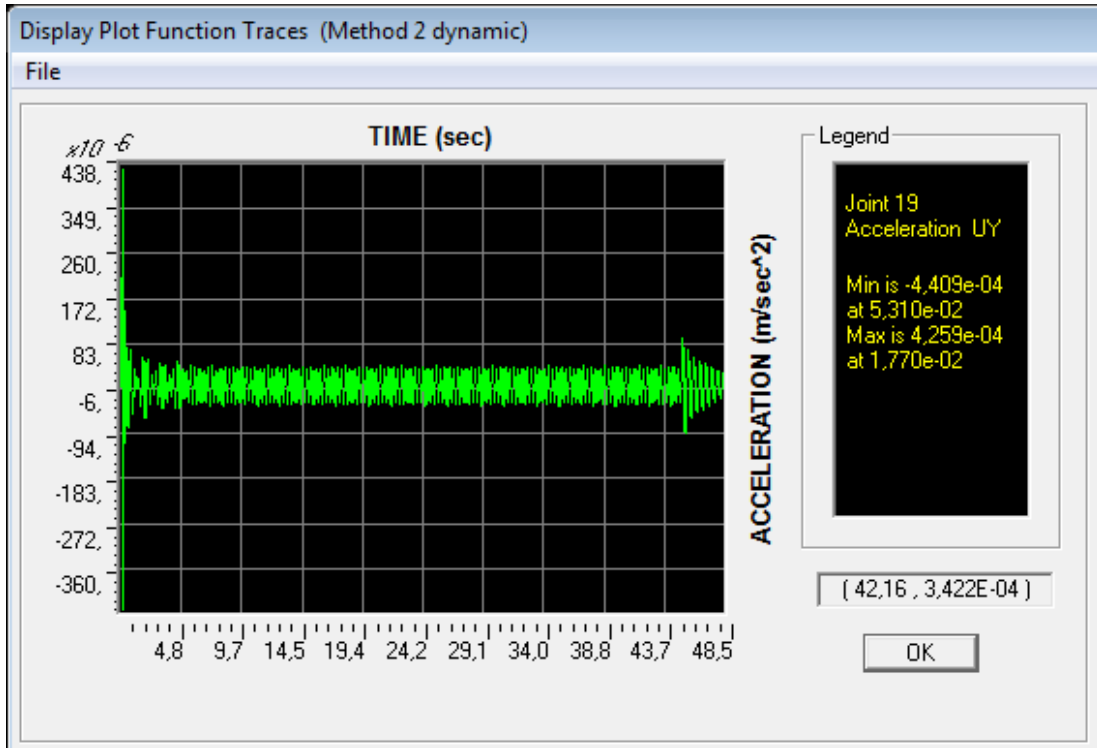

Max. acceleration in Z (vertical)		Min. acceleration in Z (vertical)	
Joint	(m/s ²)	Joint	(m/s ²)
199	0,13623379	199	-0,14223252
51	0,13563978	51	-0,14170662
216	0,13552117	17	-0,14155994
17	0,13550426	216	-0,14149262
250	0,13539722	250	-0,14135785
198	0,13074275	198	-0,13728926
200	0,13073	200	-0,13727948
49	0,13040086	49	-0,1369702
53	0,13038135	53	-0,13695936
215	0,13027478	15	-0,13682679

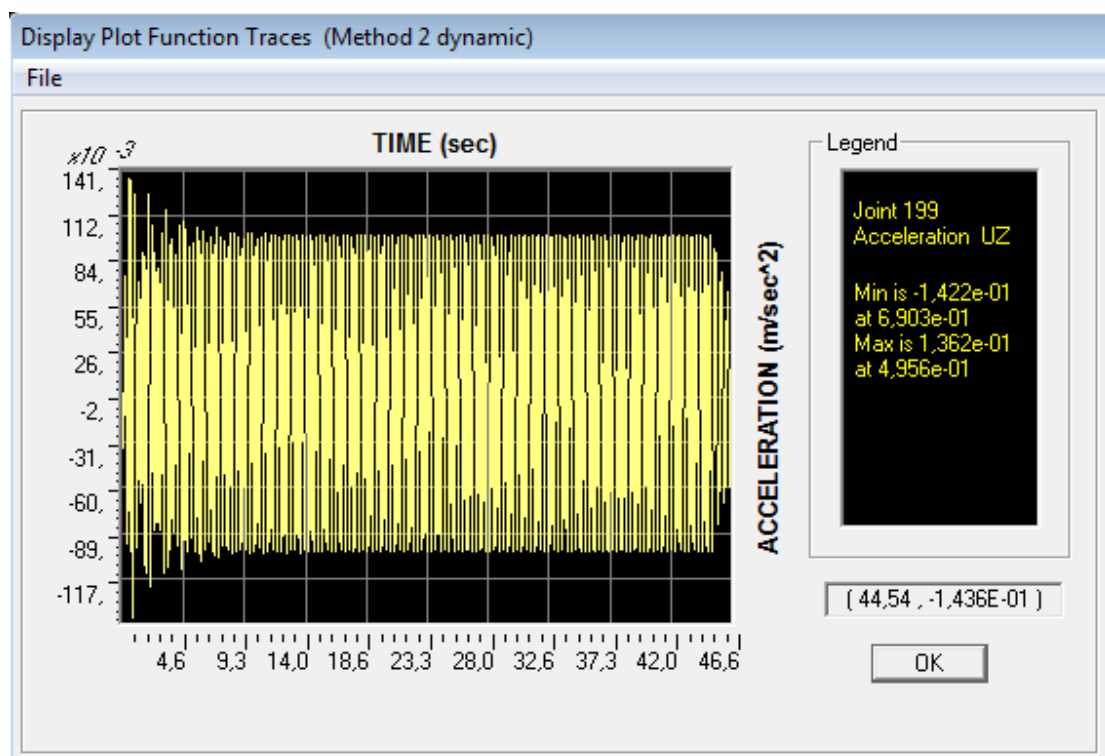

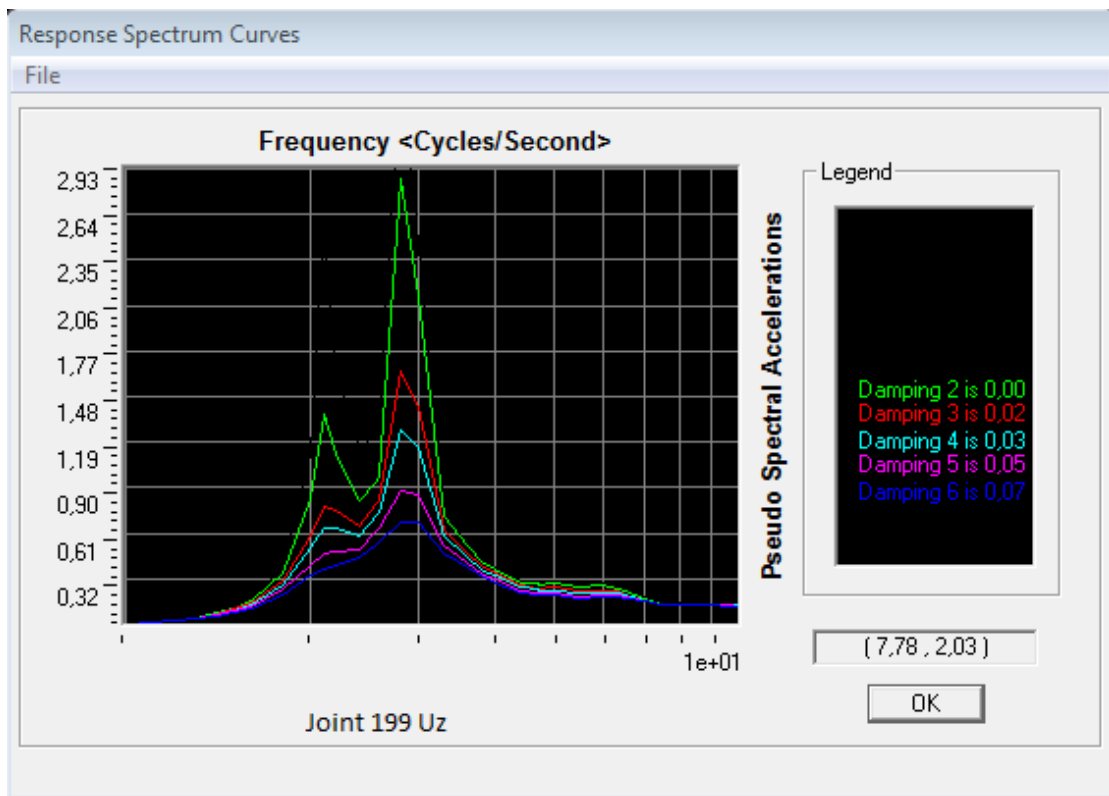

6.1.4. Acceleration results (SAP2000) of dynamic fully loaded (1 persons/m²) modal (Ritz vector)

Max. acceleration in X (longitudinal)		Min. acceleration in X (longitudinal)	
Joint	(m/s ²)	Joint	(m/s ²)
205	0,01174551	207	-0,00867575
204	0,0104825	67	-0,0085327
206	0,00958878	206	-0,00848905
203	0,00945867	33	-0,00842045
67	0,00918833	205	-0,00827945
33	0,00905206	65	-0,00825056
65	0,00847435	31	-0,00813962
31	0,00834835	204	-0,00773152
202	0,00830699	63	-0,00768963
224	0,00824871	224	-0,00761442

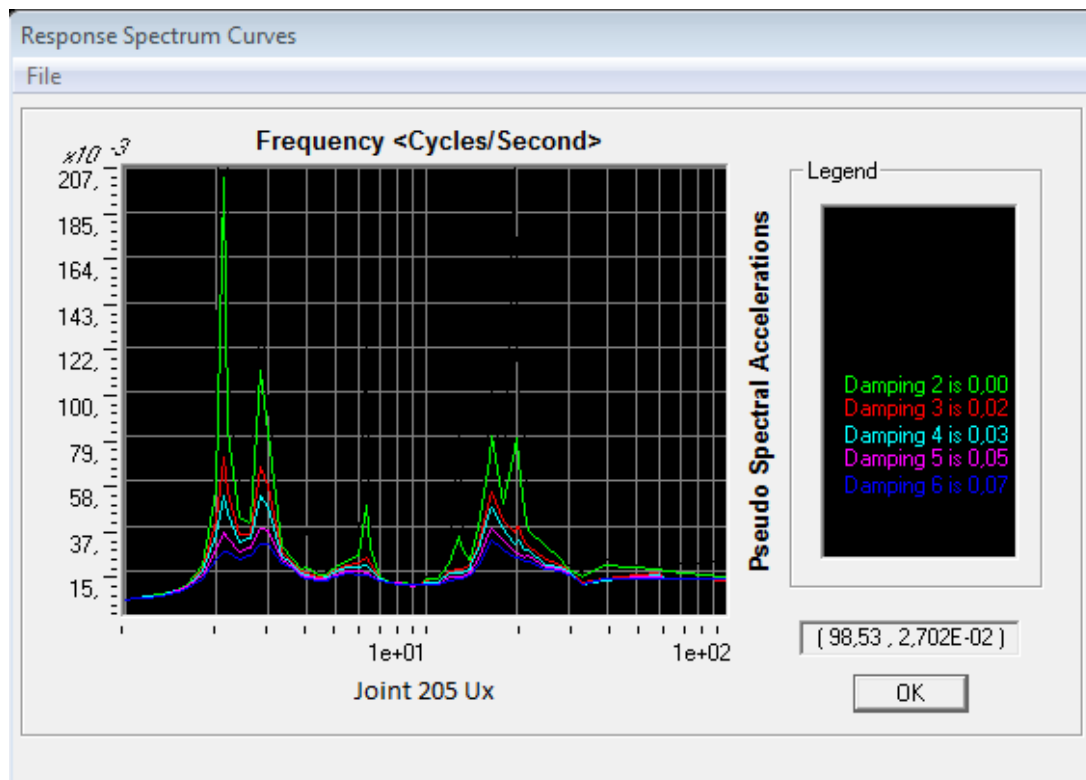
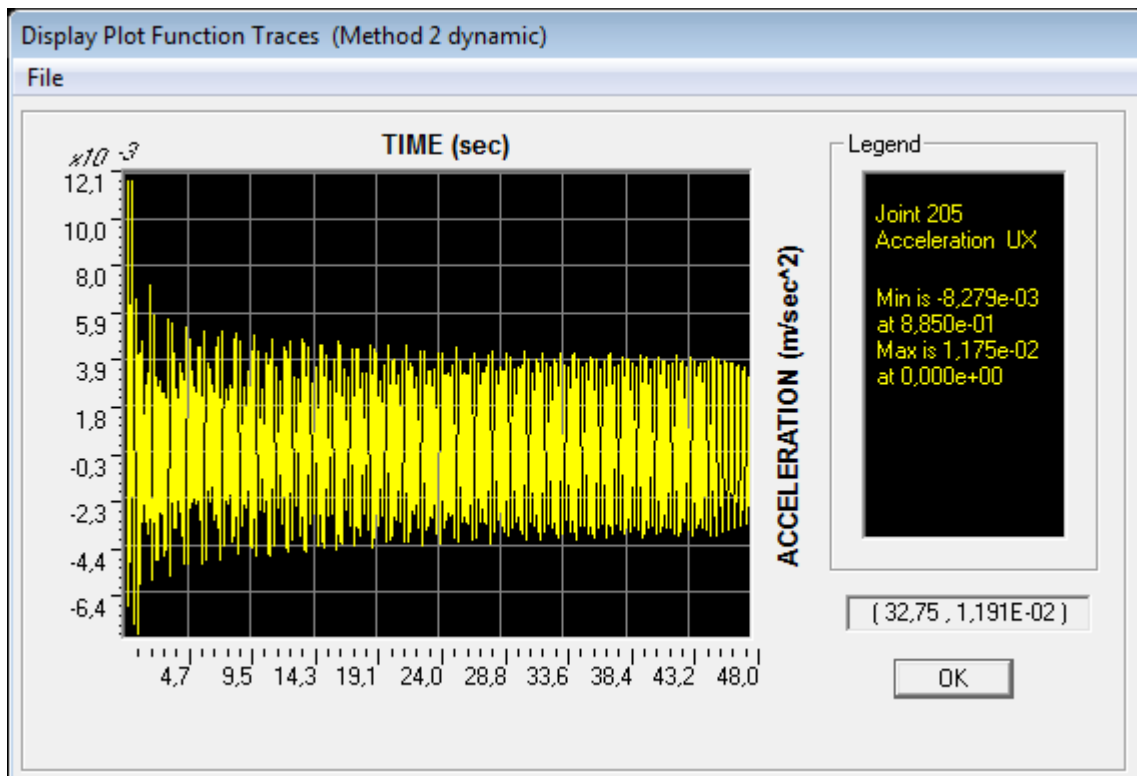

Max. acceleration in Y (horizontal)		Min. acceleration in Y (horizontal)	
Joint	(m/s ²)	Joint	(m/s ²)
242	0,01040409	208	-0,01033657
258	0,01038046	224	-0,01033244
208	0,00728987	242	-0,007326
224	0,00727529	258	-0,00730126
65	0,00658972	31	-0,00628395
37	0,00657483	3	-0,0062738
63	0,00509884	37	-0,00501471
39	0,0050409	65	-0,0049732
31	0,00499976	29	-0,0045982
3	0,00495604	5	-0,0045367

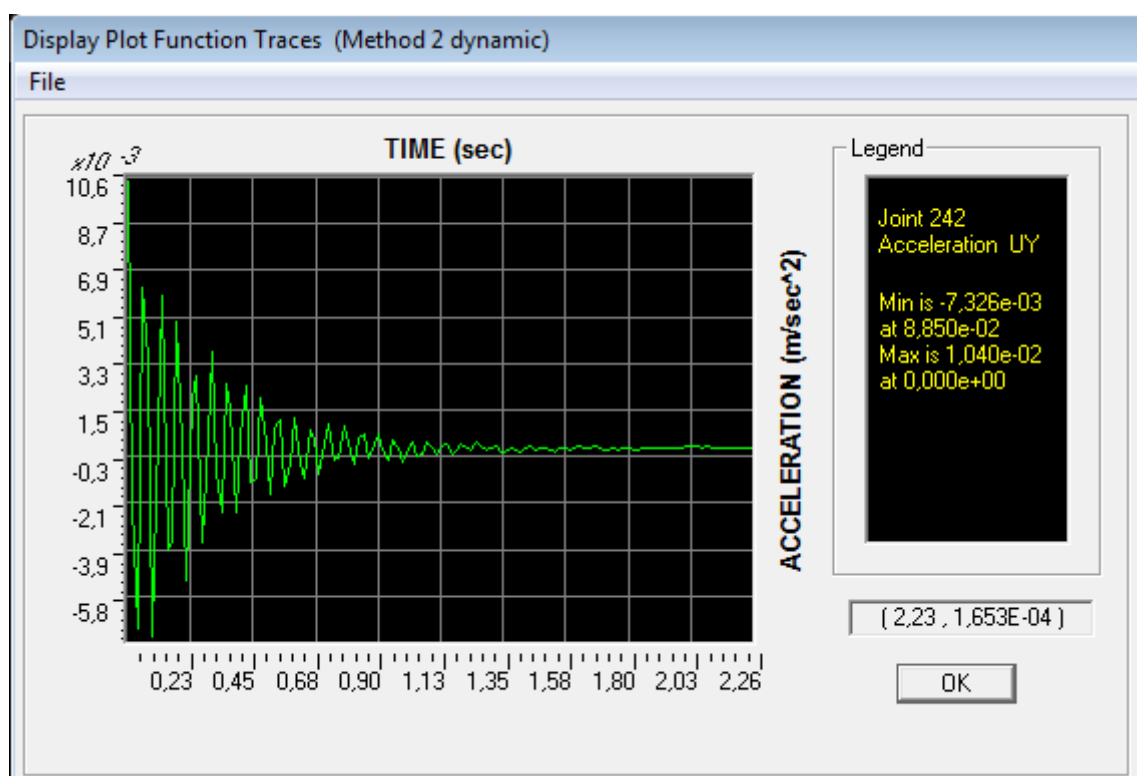

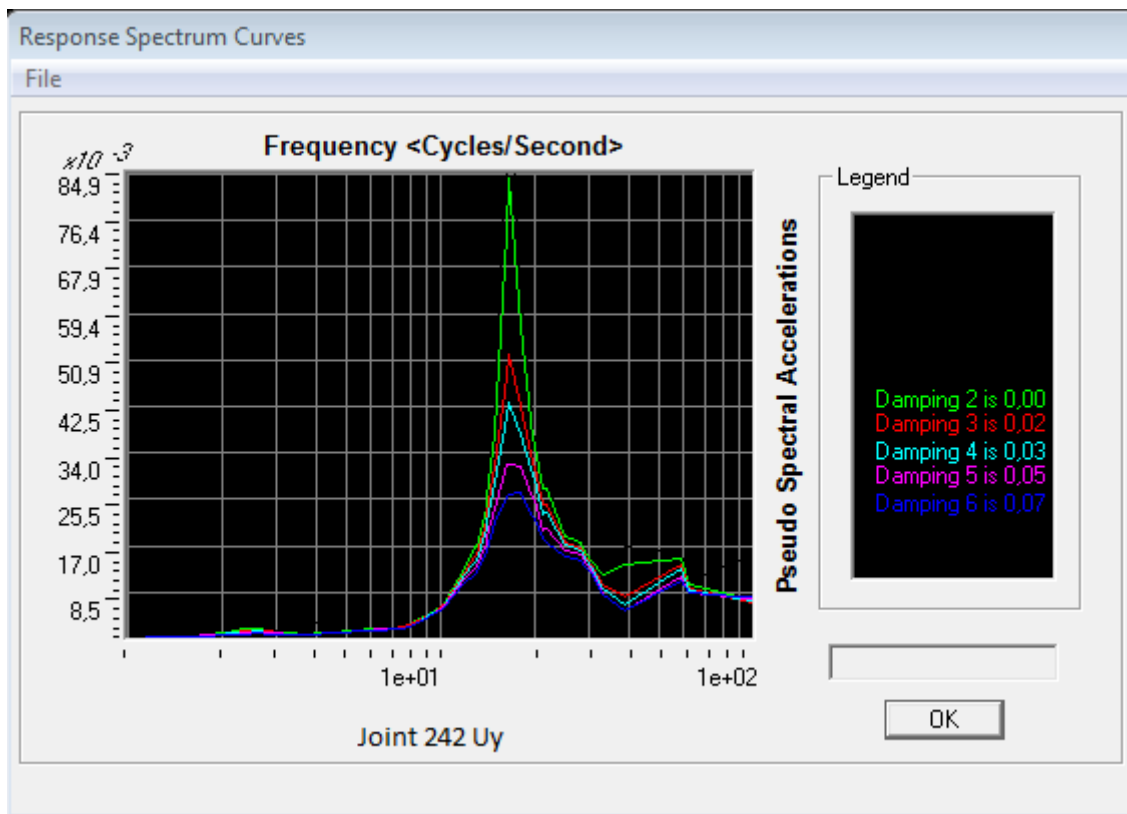

Max. acceleration in Z (vertical)		Min. acceleration in Z (vertical)	
Joint	(m/s ²)	Joint	(m/s ²)
191	0,18618532	191	-0,26776178
207	0,18615769	207	-0,26764265
199	0,16468491	199	-0,17827948
51	0,1627597	51	-0,17584017
17	0,16244634	17	-0,17532317
216	0,16227348	216	-0,16755842
250	0,1617737	250	-0,16708025
198	0,15443355	198	-0,16353126
200	0,15435511	200	-0,16349926
53	0,15356755	49	-0,16127576

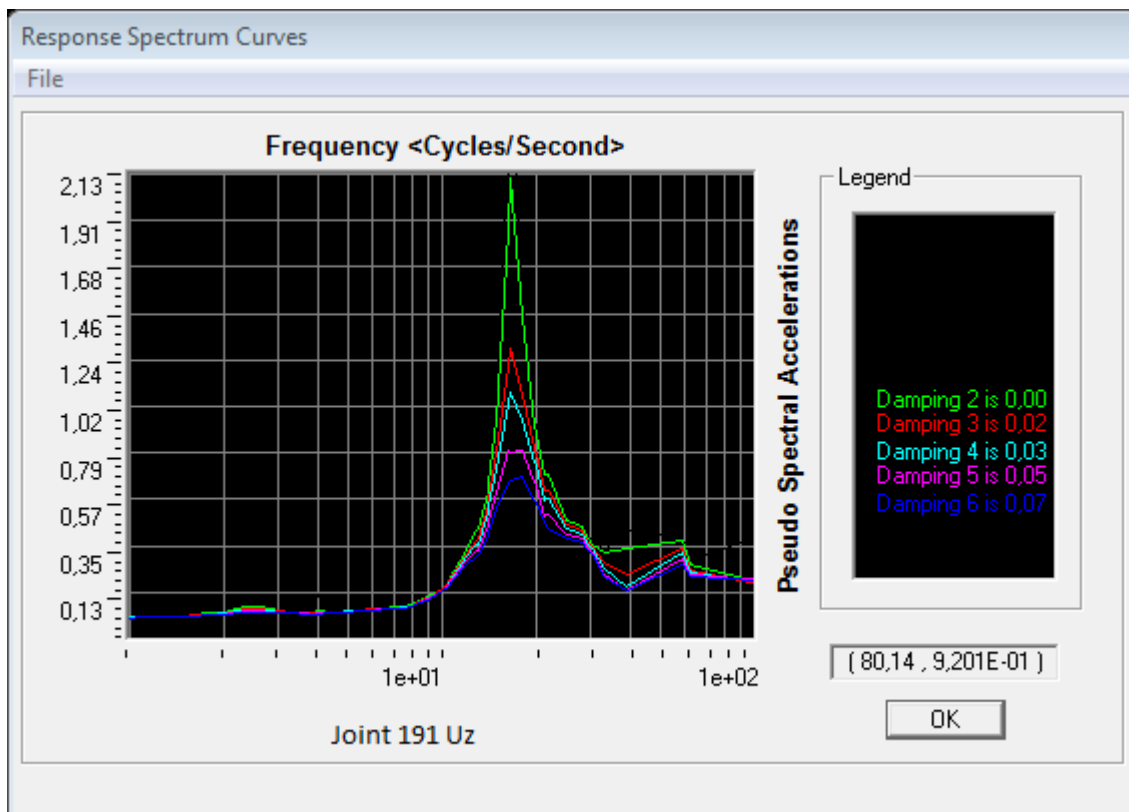
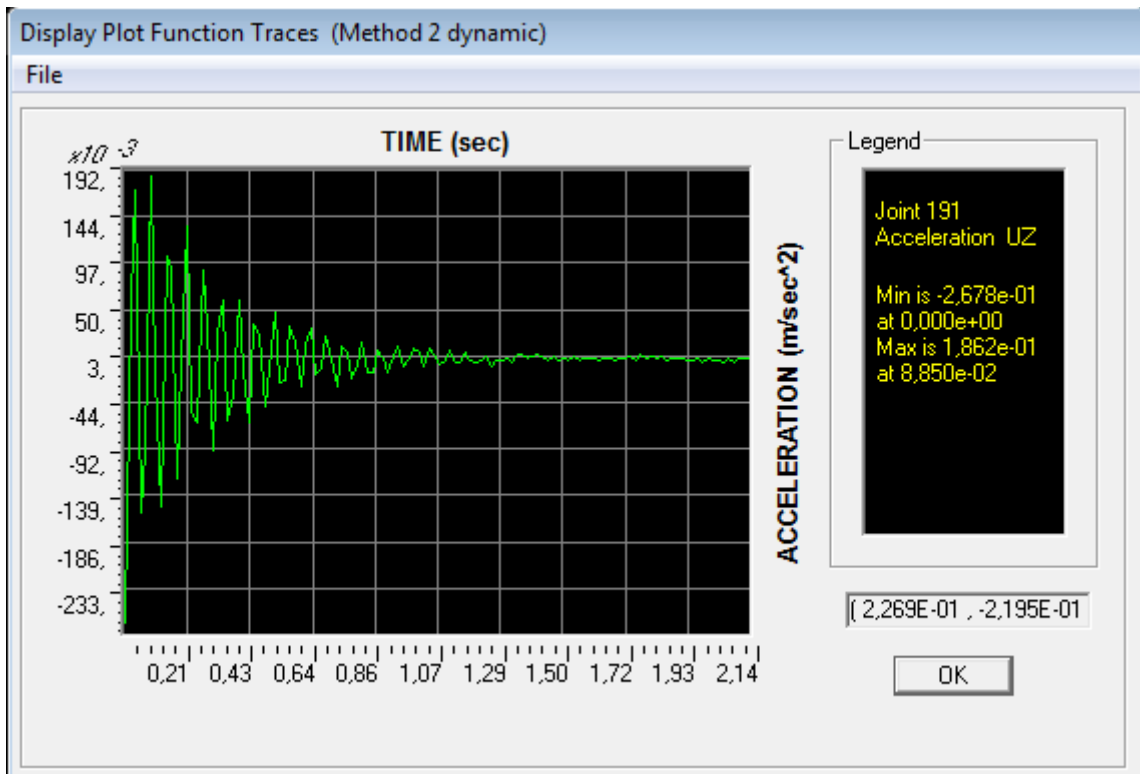

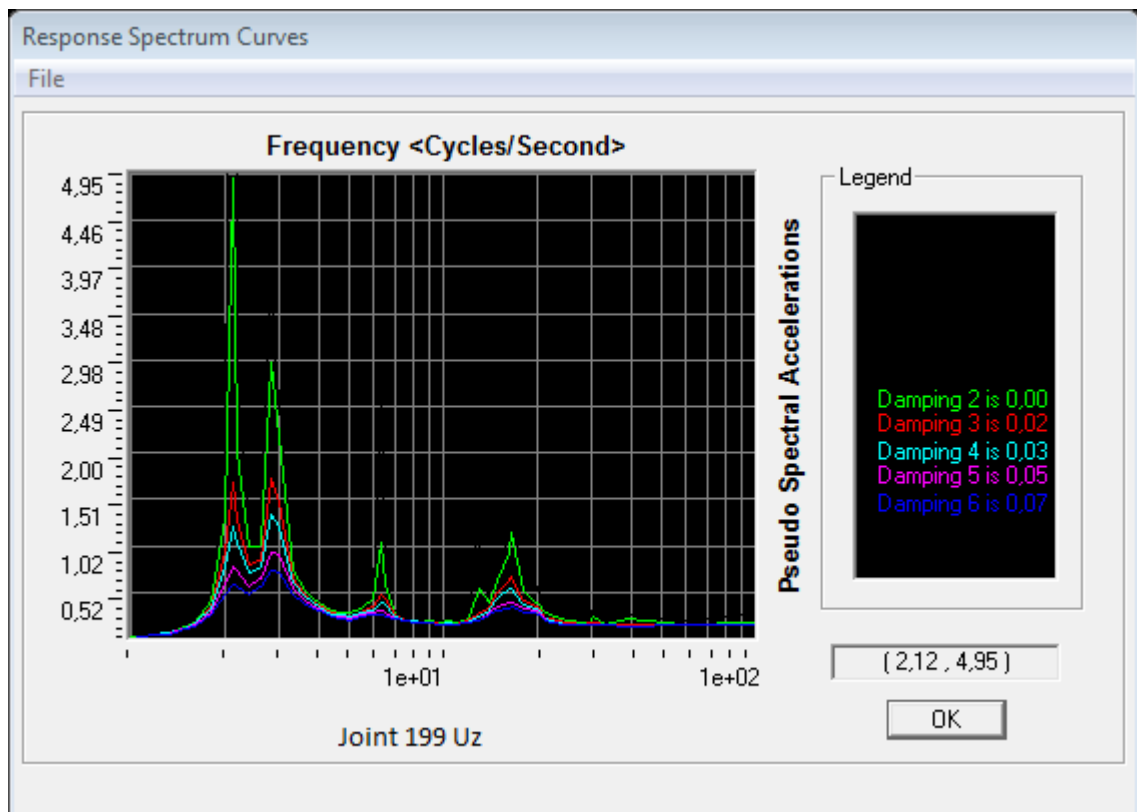
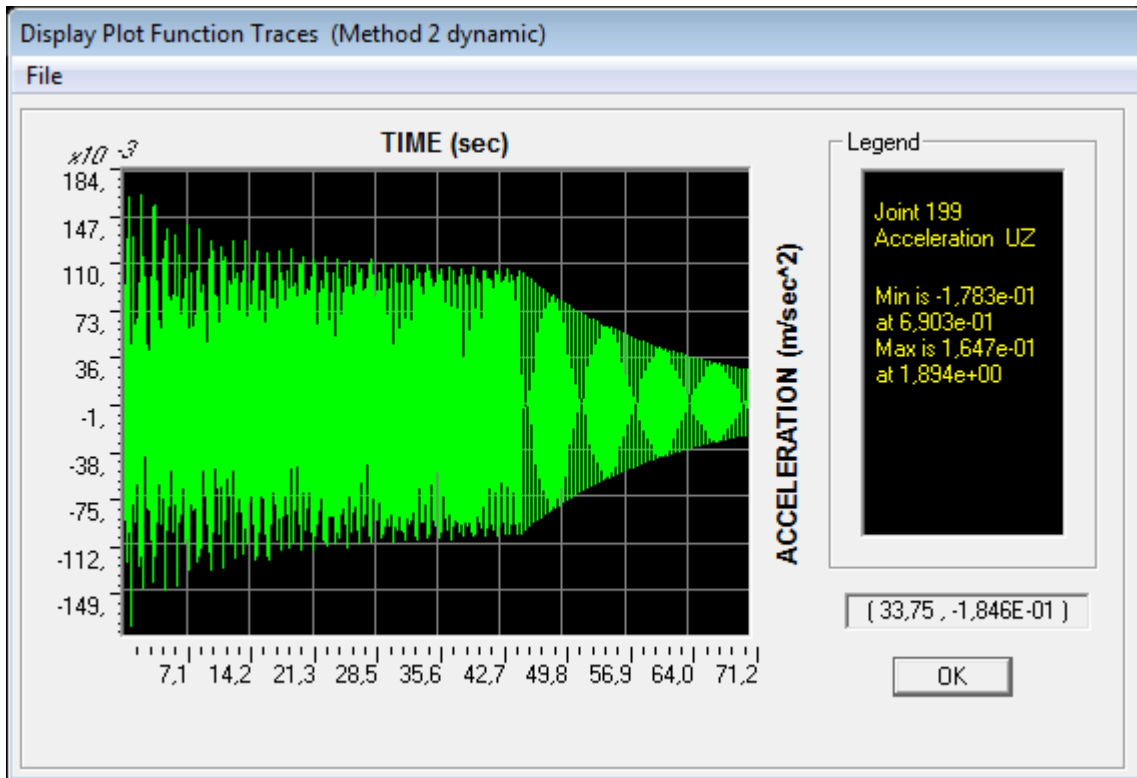

6.2. Method 3: (Unconventional Time History)

This method is described on chapter 5.3

Modes for 2 persons

OutputCase	StepType	StepNum	Period	Frequency	CircFreq	Eigenvalue	Nature of mode
MODAL	Mode	1	0,34641298	2,88672783	18,1378459	328,981454	1st vertical
MODAL	Mode	2	0,28014054	3,56963682	22,4286896	503,046117	1st torsion
MODAL	Mode	3	0,19184154	5,21263539	32,7519541	1072,6905	2nd vertical
MODAL	Mode	4	0,1523192	6,56516056	41,2501204	1701,57243	2nd torsion
MODAL	Mode	5	0,11591045	8,62734954	54,2072359	2938,42442	3rd vertical
MODAL	Mode	6	0,10266766	9,7401652	61,1992628	3745,34977	1st lateral
MODAL	Mode	7	0,07705883	12,9770977	81,5375096	6648,36548	
MODAL	Mode	8	0,07049868	14,1846633	89,1248682	7943,24213	
MODAL	Mode	9	0,05754283	17,3783589	109,191449	11922,7726	
MODAL	Mode	10	0,05587253	17,8978822	112,455711	12646,2868	
MODAL	Mode	11	0,04889914	20,4502581	128,492761	16510,3897	
MODAL	Mode	12	0,04787905	20,8859634	131,230378	17221,4122	
MODAL	Mode	13	0,0452965	22,0767594	138,71237	19241,1217	
MODAL	Mode	14	0,03720374	26,8790145	168,885829	28522,4232	
MODAL	Mode	15	0,03111804	32,1357036	201,914581	40769,4979	
MODAL	Mode	16	0,02399318	41,678506	261,873776	68577,8748	
MODAL	Mode	17	0,02163815	46,214672	290,375348	84317,8427	
MODAL	Mode	18	0,01511887	66,1425045	415,585612	172711,401	
MODAL	Mode	19	0,012854	77,7968147	488,811803	238936,979	
MODAL	Mode	20	0,00148422	673,752807	4233,31374	17920945,2	

6.2.1. Acceleration results (SAP2000) of 2 persons in direct integration

Max. acceleration in X (longitudinal)		Min. acceleration in X (longitudinal)	
Joint	(m/s ²)	Joint	(m/s ²)
31	0,03396317	9	-0,02632128
65	0,03396125	43	-0,02631509
33	0,03393293	7	-0,02600638
67	0,03393191	41	-0,0260008
29	0,03391624	11	-0,0257169
63	0,03391398	45	-0,02571024
27	0,03379529	196	-0,02508288
61	0,03379277	13	-0,02470531
205	0,03369689	47	-0,02469839
204	0,03367956	195	-0,02462383

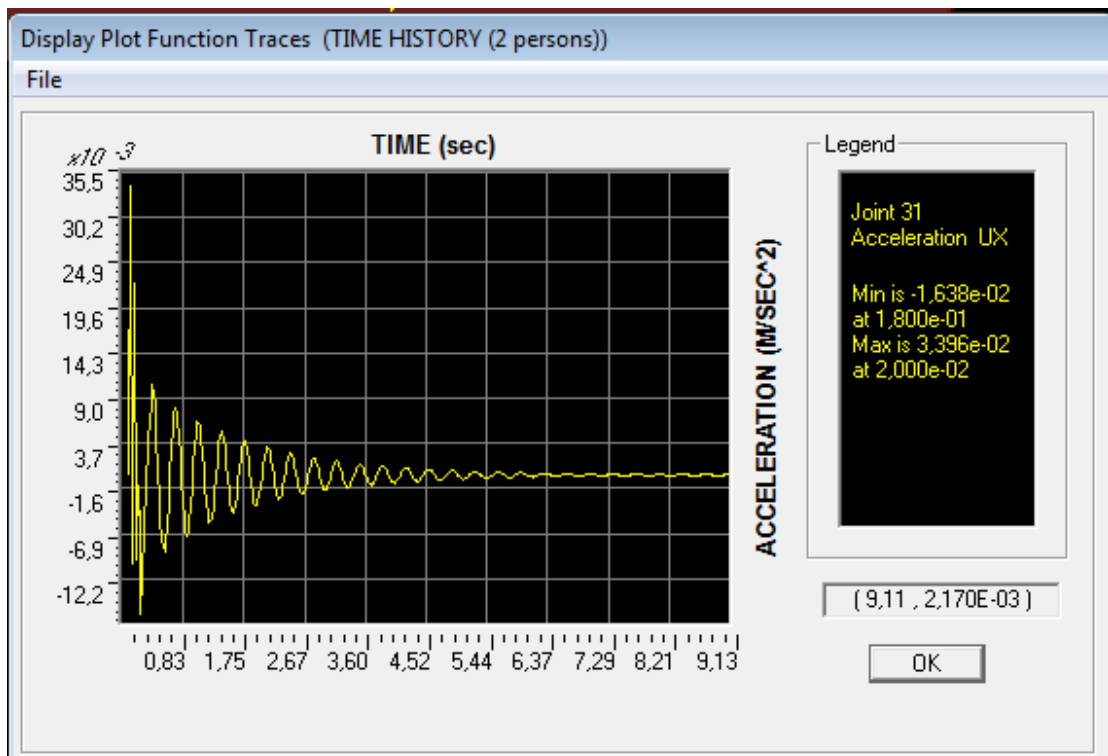

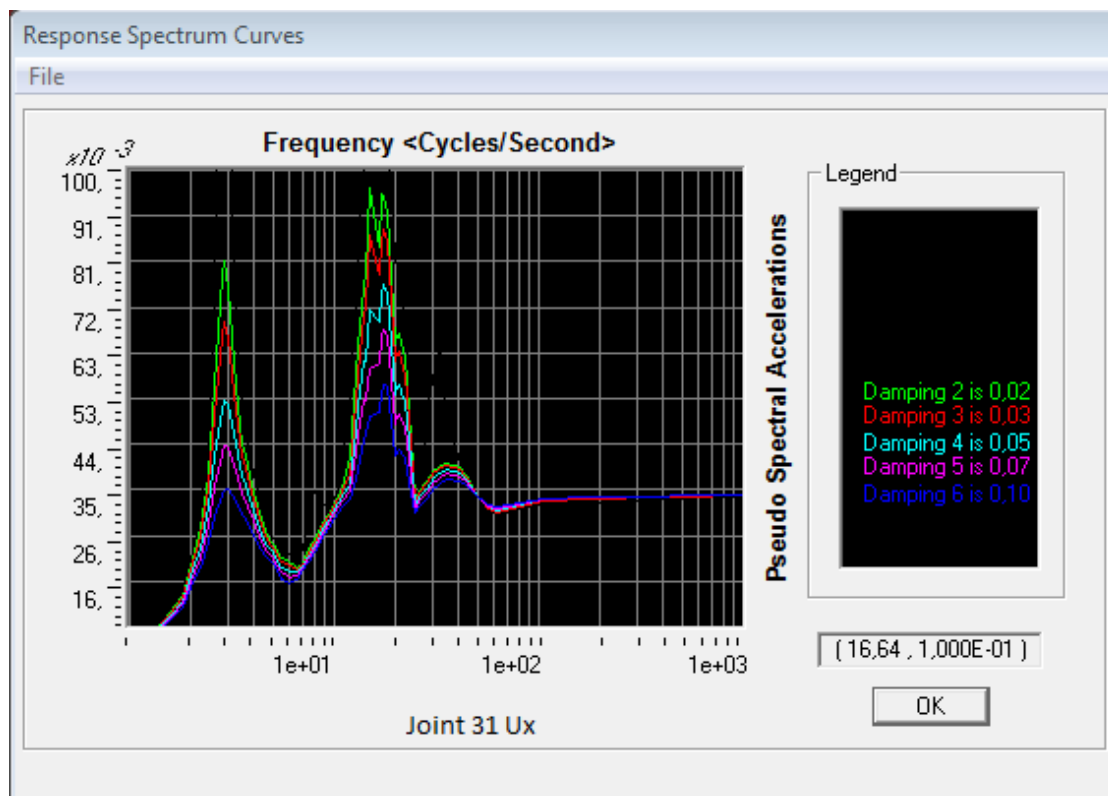

Max. acceleration in Y (horizontal)		Min. acceleration in Y (horizontal)	
Joint	(m/s ²)	Joint	(m/s ²)
39	0,00244544	5	-0,00244471
41	0,00226118	7	-0,00226101
9	0,00222664	43	-0,00222776
37	0,00199394	3	-0,00199136
7	0,0019742	41	-0,00197596
5	0,0019294	39	-0,00193152
43	0,00186641	9	-0,00186679
3	0,00159161	37	-0,00159364
47	0,00143182	13	-0,00143085
49	0,00140636	15	-0,00140591

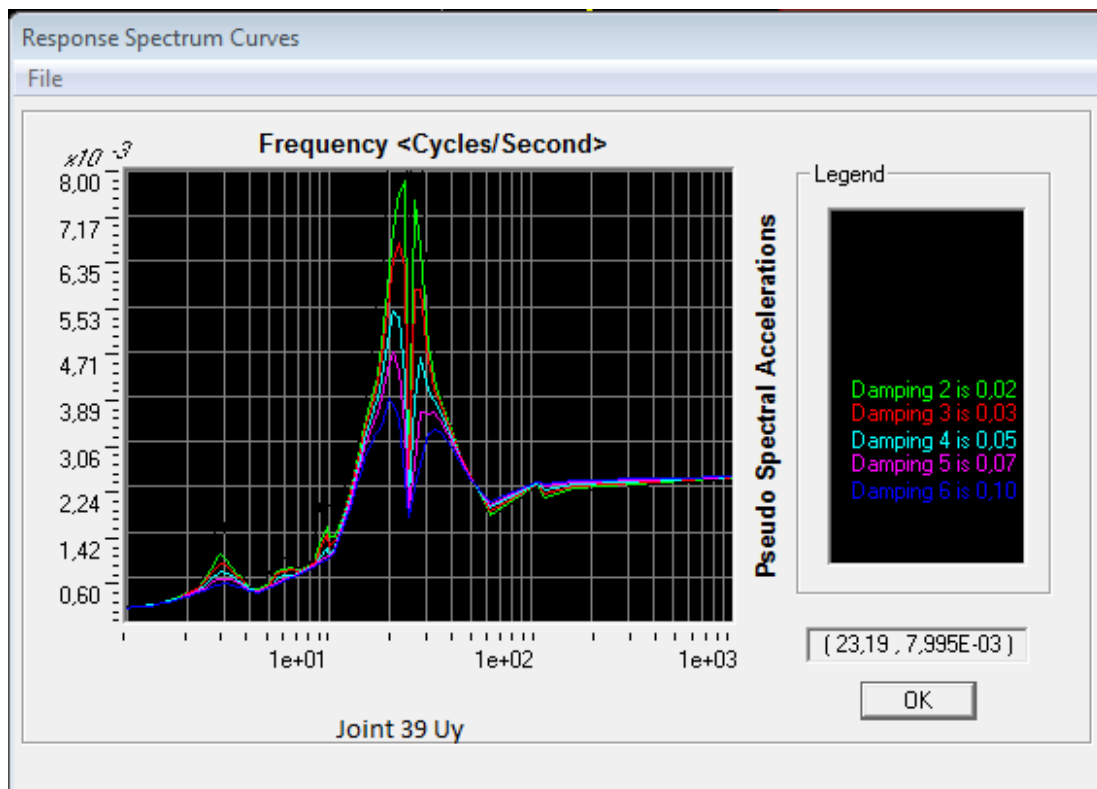
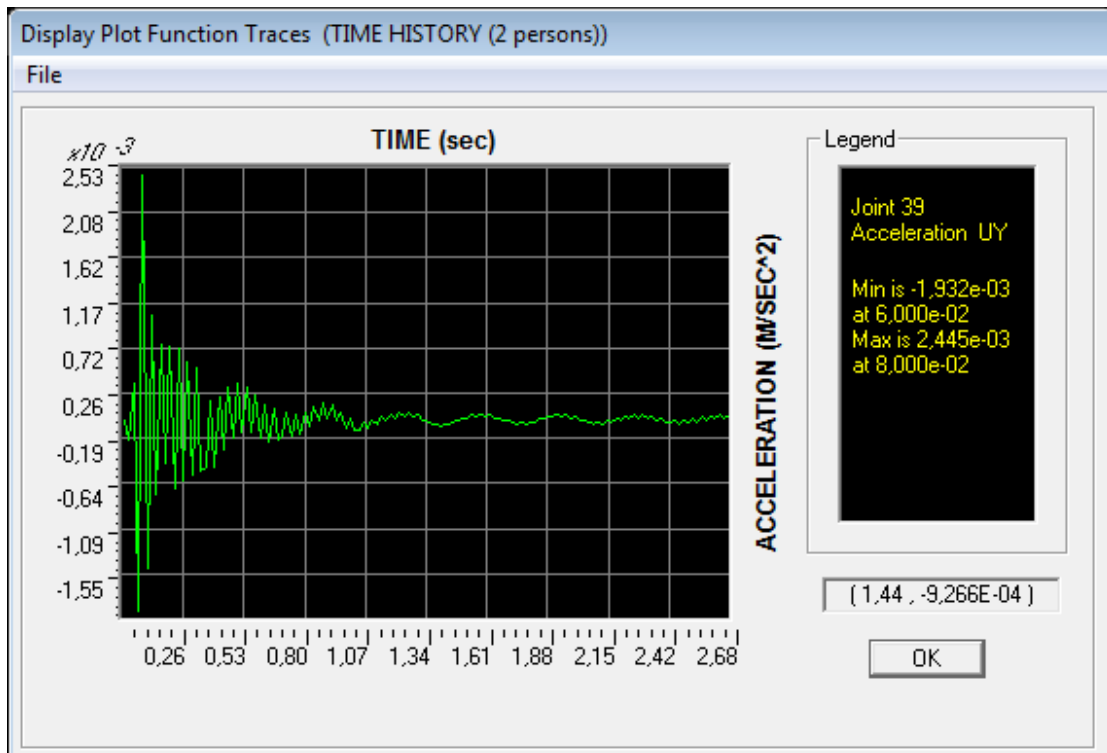

Max. acceleration in Z (vertical)		Min. acceleration in Z (vertical)	
Joint	(m/s ²)	Joint	(m/s ²)
202	0,28308867	196	-0,39560349
203	0,28116482	197	-0,37969695
57	0,28056524	195	-0,36873922
23	0,28056512	198	-0,34315022
219	0,27362052	43	-0,33980347
253	0,27362049	9	-0,33980308
59	0,27348172	7	-0,33480865
25	0,27348155	41	-0,33480855
220	0,26934374	212	-0,32835443
254	0,26934361	246	-0,32835414

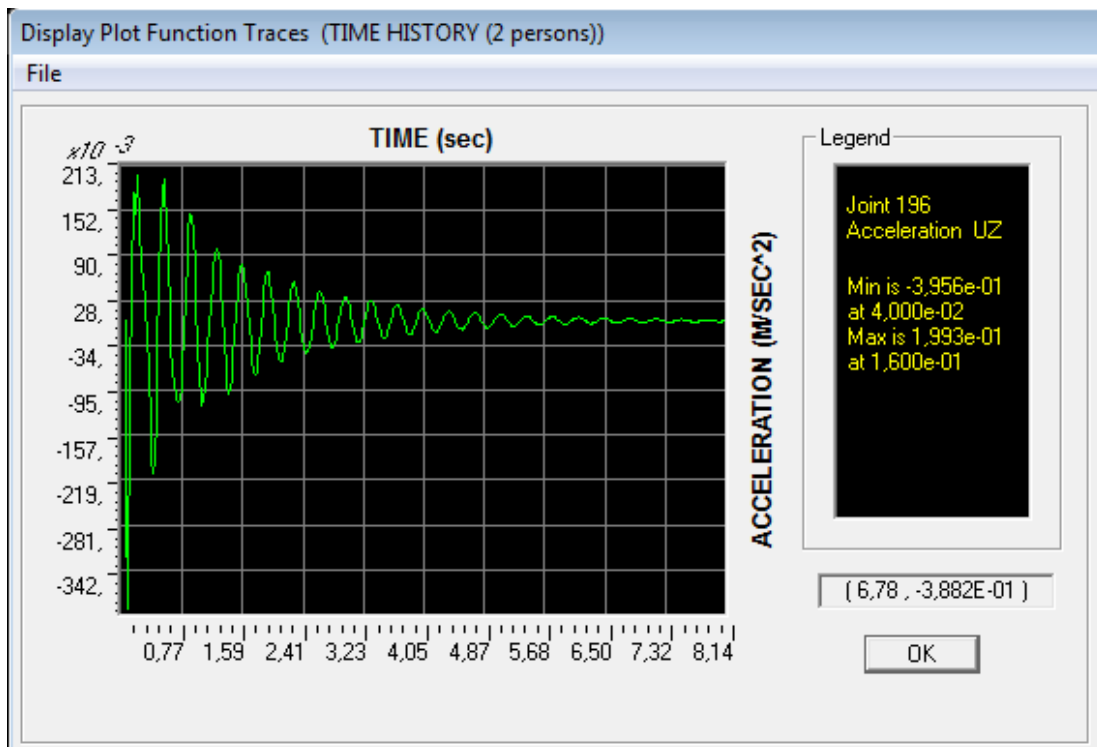

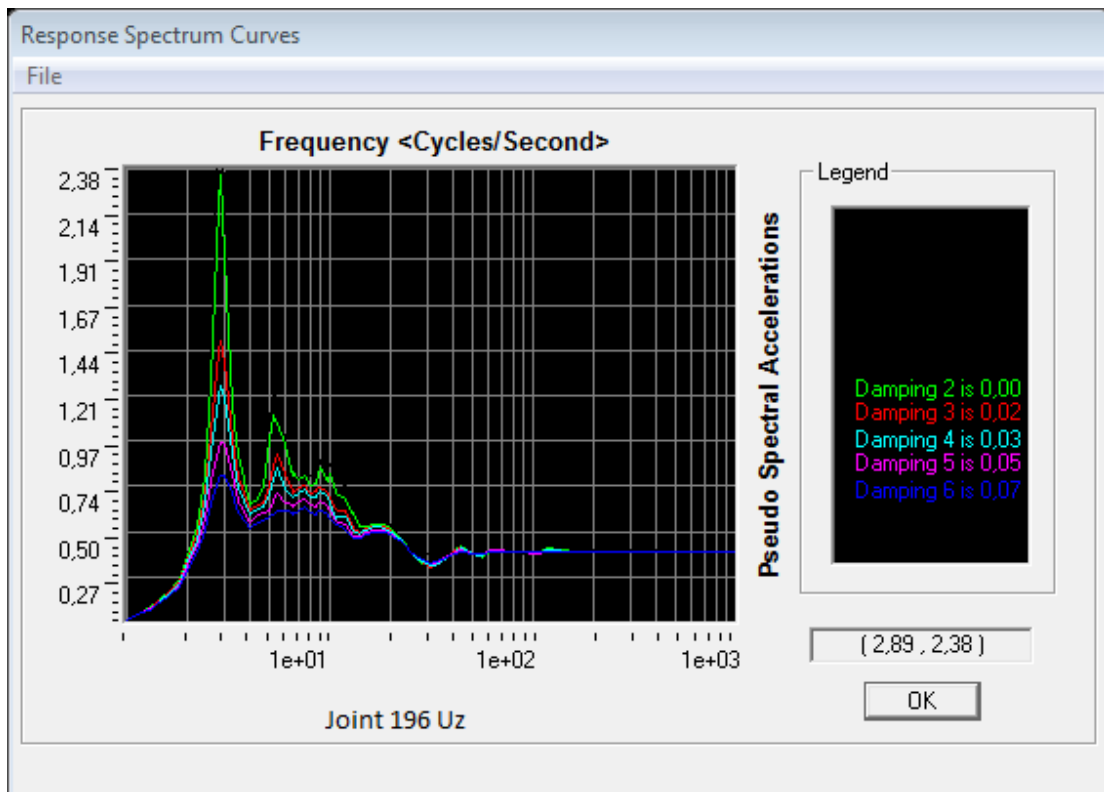

6.2.2. Acceleration results (SAP2000) of 2 persons in modal (Ritz vector)

Max. acceleration in X (longitudinal)		Min. acceleration in X (longitudinal)	
Joint	(m/s ²)	Joint	(m/s ²)
194	0,403781	205	-0,30584615
193	0,40231765	193	-0,26439413
195	0,40213697	194	-0,26224906
196	0,38153996	204	-0,26118655
197	0,31495194	195	-0,2548254
198	0,2922181	206	-0,25052945
192	0,24466201	196	-0,23814903
205	0,22309243	203	-0,23413056
204	0,19386292	202	-0,19938486
206	0,18299688	197	-0,19347999

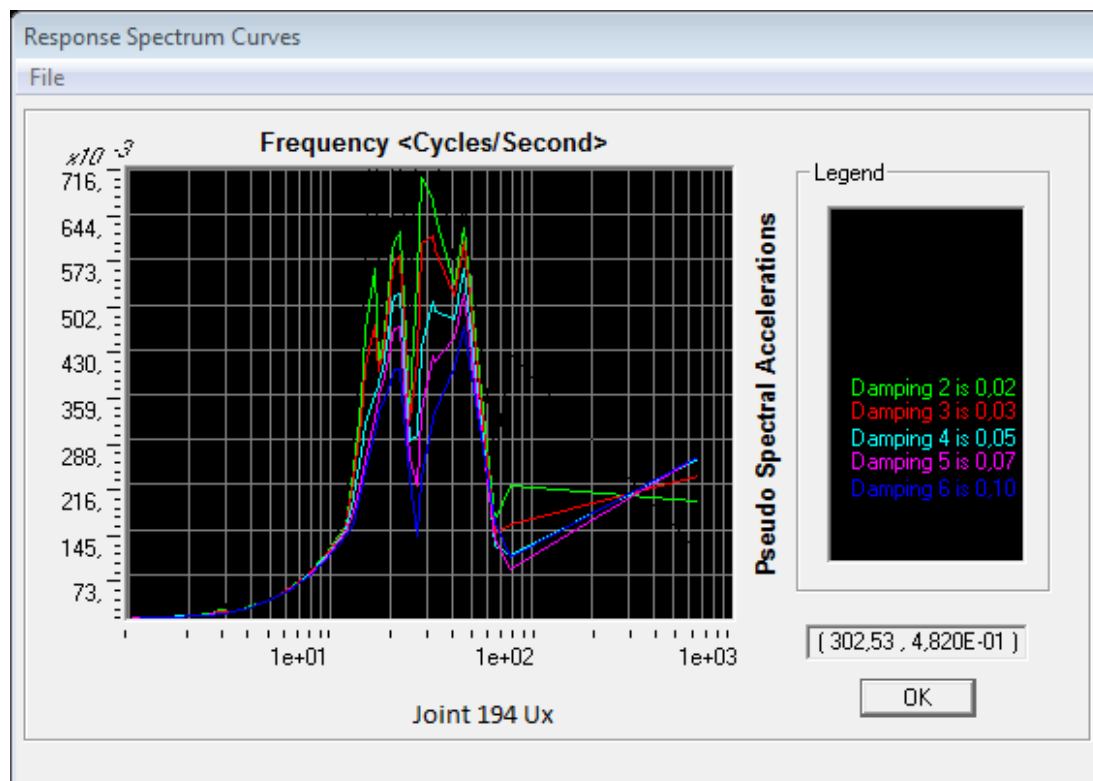
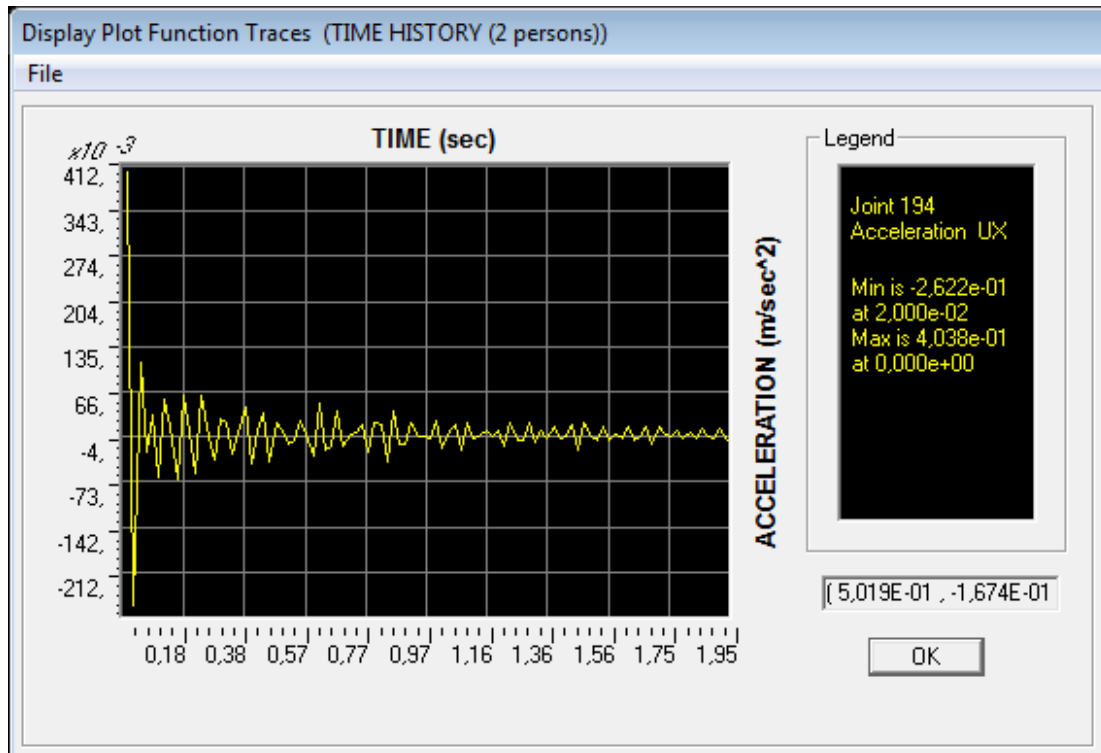

Max. acceleration in Y (horizontal)		Min. acceleration in Y (horizontal)	
Joint	(m/s ²)	Joint	(m/s ²)
224	0,16922037	258	-0,16922112
208	0,1661082	242	-0,1661092
258	0,11321954	224	-0,11321995
242	0,11141448	208	-0,11141498
3	0,10682455	37	-0,10682796
31	0,10344261	65	-0,10344481
5	0,08928671	39	-0,08929152
29	0,08186795	63	-0,08187052
37	0,07464979	3	-0,07465134
65	0,0729418	31	-0,07294285

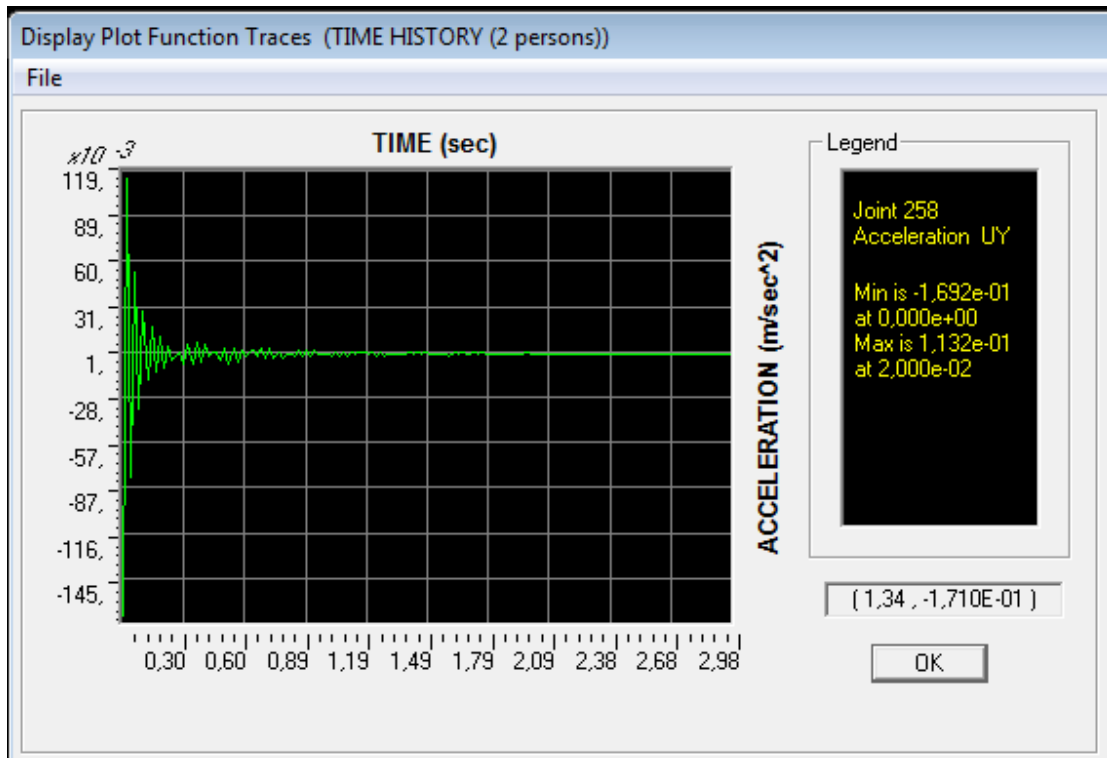

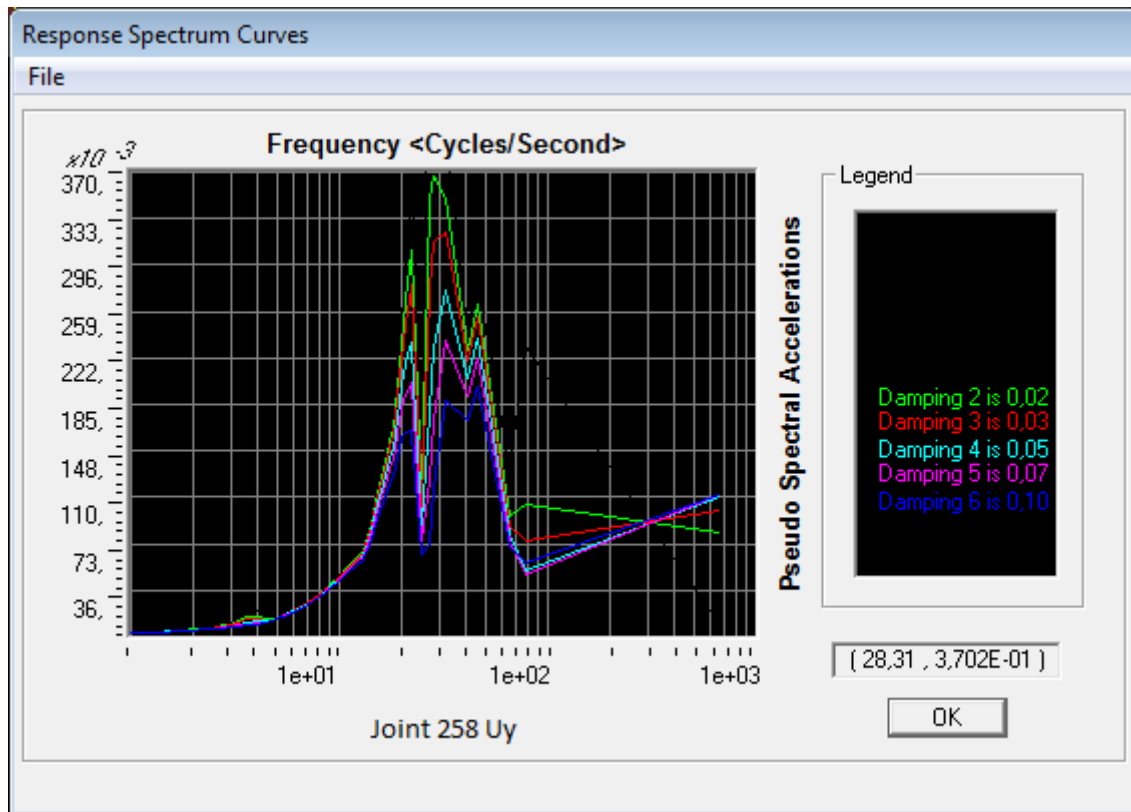

Max. acceleration in Z (vertical)		Min. acceleration in Z (vertical)	
Joint	(m/s ²)	Joint	(m/s ²)
199	0,54878945	45	-0,91202917
201	0,54100848	11	-0,91202785
202	0,52643358	39	-0,88192839
207	0,51899828	5	-0,8819283
191	0,51637986	13	-0,83332496
196	0,46983353	47	-0,83332467
198	0,46466499	192	-0,82549282
195	0,43489439	43	-0,81803976
213	0,42042437	9	-0,81803786
247	0,42042406	15	-0,80006747

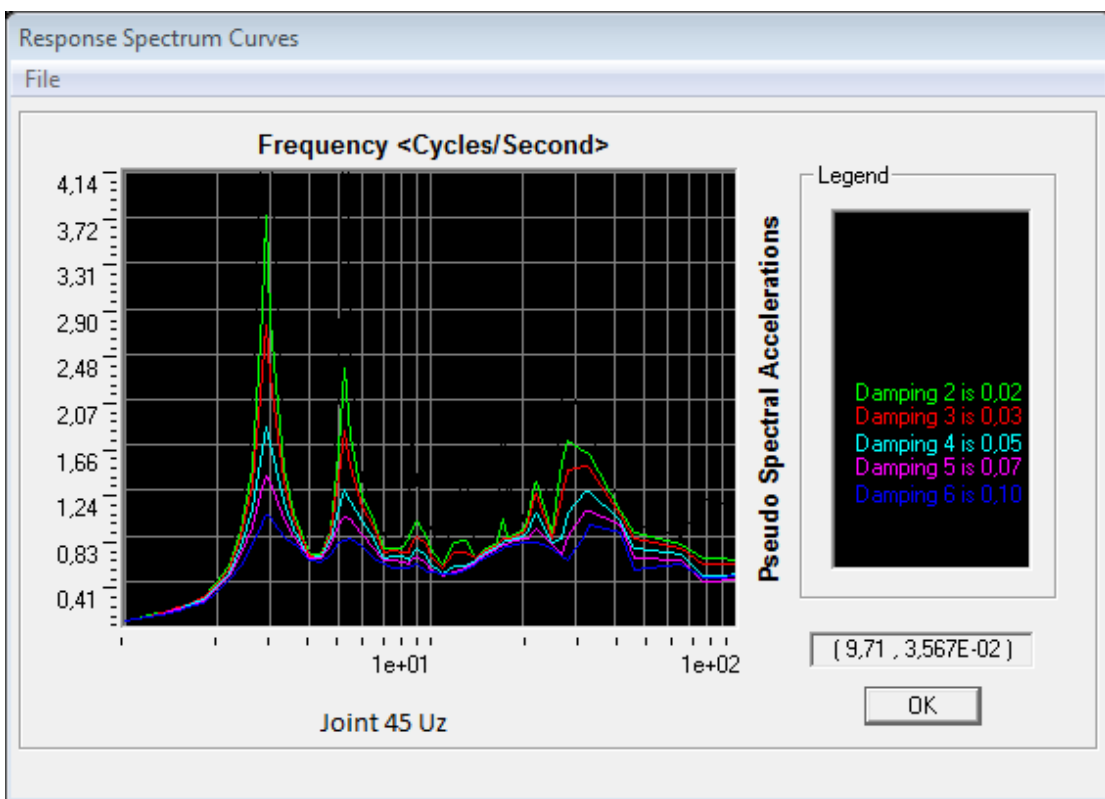
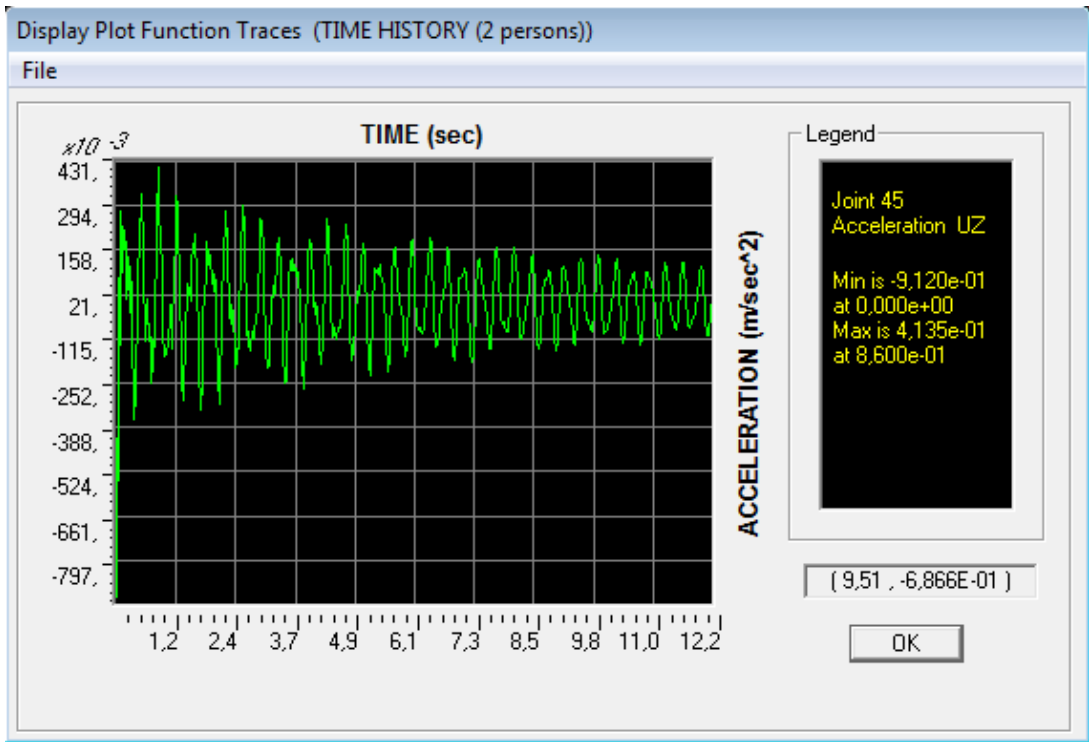

Modes for 4 persons

OutputCase	StepType	StepNum	Period	Frequency	CircFreq	Eigenvalue
MODAL	Mode	1	0,50151859	1,99394402	12,5283198	156,958797
MODAL	Mode	2	0,30313299	3,2988821	20,7274875	429,62874
MODAL	Mode	3	0,26273983	3,80604652	23,9140956	571,883967
MODAL	Mode	4	0,15855047	6,30713996	39,6289291	1570,45202
MODAL	Mode	5	0,14670947	6,81619237	42,8273997	1834,18617
MODAL	Mode	6	0,0926618	10,7919333	67,807717	4597,88649
MODAL	Mode	7	0,08988002	11,1259427	69,9063596	4886,89911
MODAL	Mode	8	0,06559428	15,2452315	95,7886146	9175,45869
MODAL	Mode	9	0,06261063	15,9717283	100,353329	10070,7906
MODAL	Mode	10	0,05577853	17,9280456	112,645233	12688,9484
MODAL	Mode	11	0,05130466	19,4914078	122,468127	14998,4422
MODAL	Mode	12	0,04846964	20,631472	129,631362	16804,29
MODAL	Mode	13	0,04076427	24,5312859	154,134615	23757,4795
MODAL	Mode	14	0,0376536	26,5578882	166,868133	27844,9737
MODAL	Mode	15	0,02622274	38,1348375	239,608251	57412,1139
MODAL	Mode	16	0,02161133	46,2720296	290,735737	84527,2686
MODAL	Mode	17	0,02028893	49,2879604	309,685389	95905,04
MODAL	Mode	18	0,01381581	72,3808246	454,782134	206826,789
MODAL	Mode	19	0,01129683	88,5204014	556,190086	309347,411
MODAL	Mode	20	0,00106983	934,731301	5873,08998	34493185,9

6.2.3. Acceleration results (SAP2000) of 4 persons in direct integration

Max. acceleration in X (longitudinal)		Min. acceleration in X (longitudinal)	
Joint	(m/s ²)	Joint	(m/s ²)
13	0,02729716	7	-0,03057785
47	0,02729209	41	-0,03056704
15	0,02727883	9	-0,02986675
49	0,02727366	43	-0,02985526
11	0,0272668	11	-0,02899022
45	0,02726188	45	-0,02897817
200	0,02721185	5	-0,02849569
17	0,02705619	39	-0,0284861
51	0,02705086	13	-0,0279359
201	0,02698028	47	-0,02792359

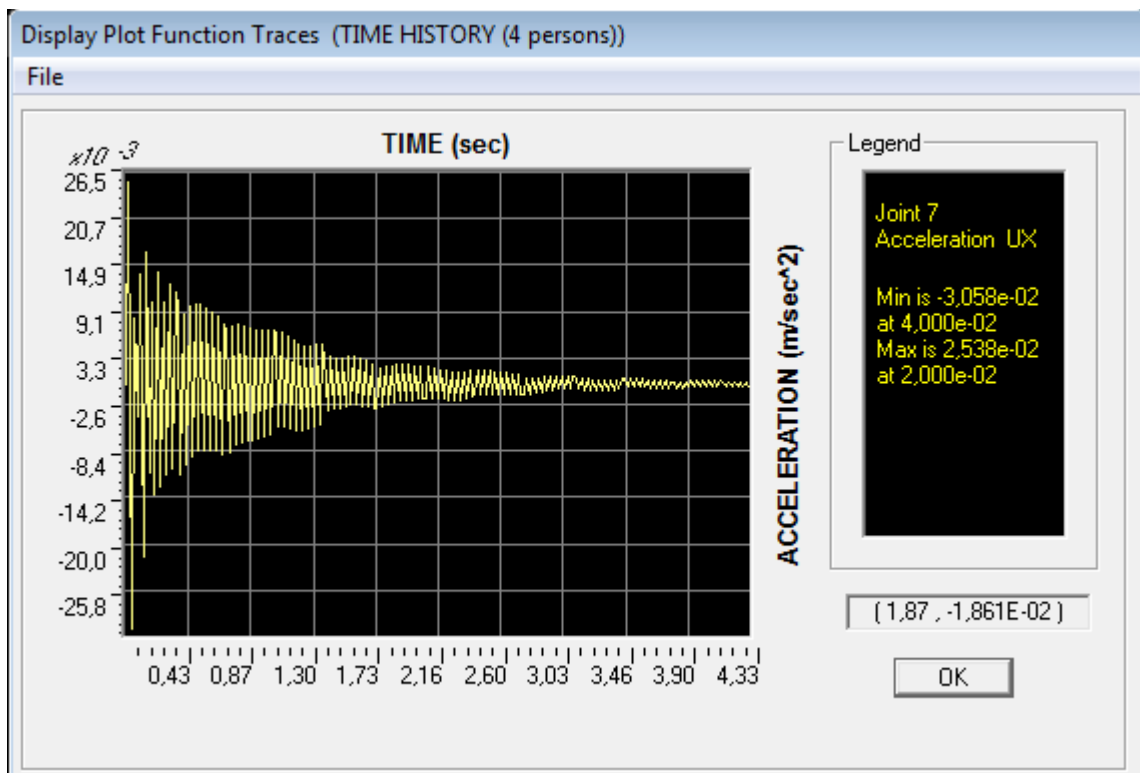

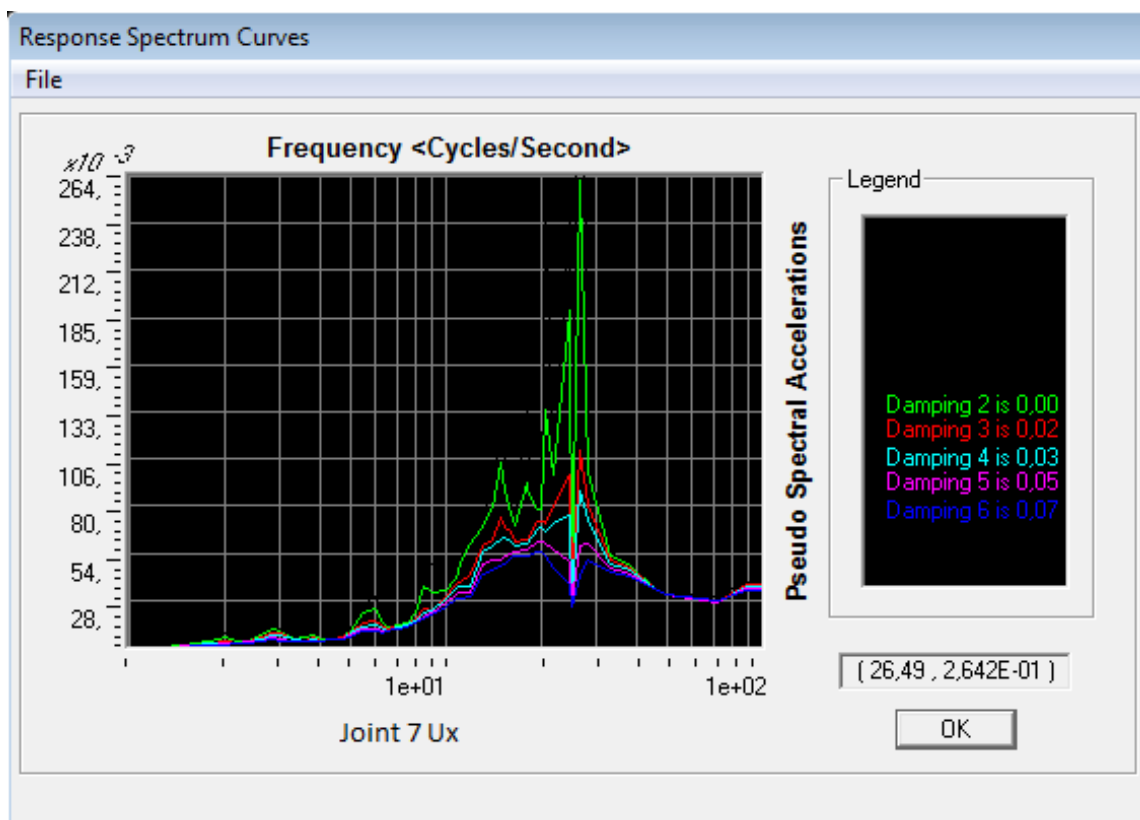

Max. acceleration in Y (horizontal)		Min. acceleration in Y (horizontal)	
Joint	(m/s ²)	Joint	(m/s ²)
7	0,0037768	41	-0,0037741
11	0,00335573	45	-0,00335365
5	0,00318367	39	-0,00318101
9	0,00315656	43	-0,00315421
13	0,00302076	47	-0,0030215
45	0,00289041	11	-0,00289019
47	0,00279823	13	-0,00279856
15	0,00278985	49	-0,00279029
17	0,00258512	51	-0,0025858
49	0,00254214	15	-0,00254278

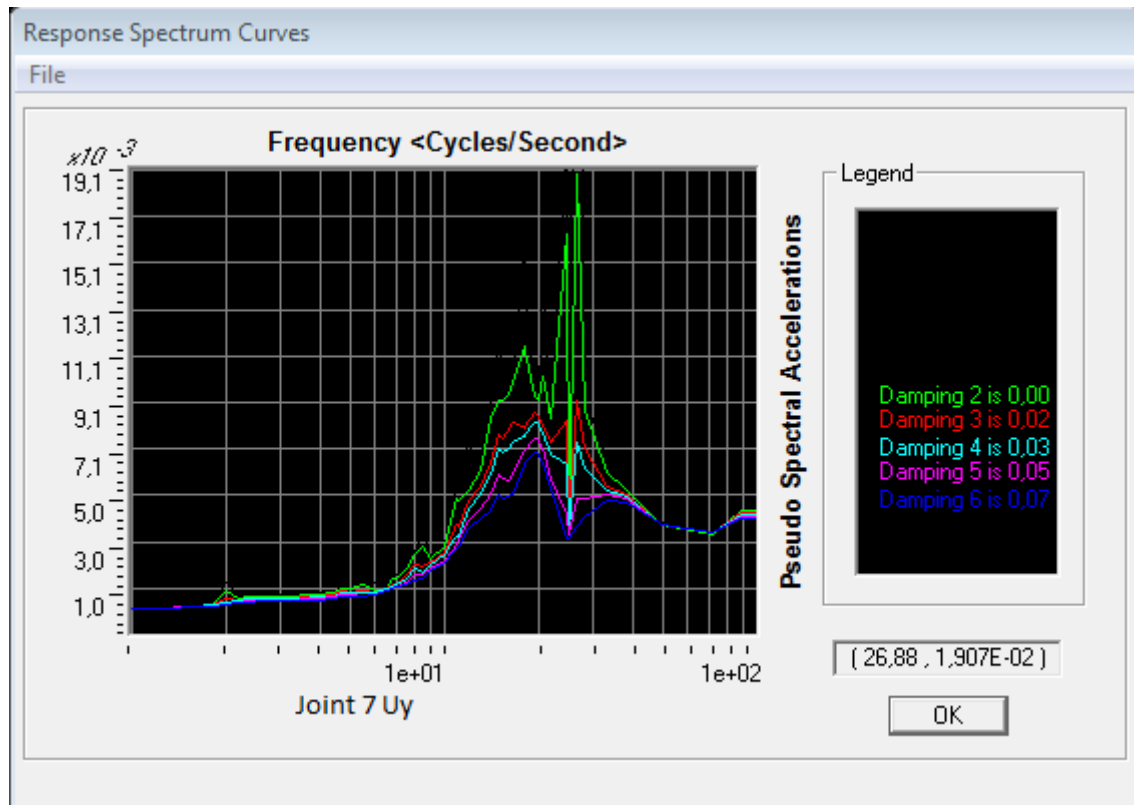
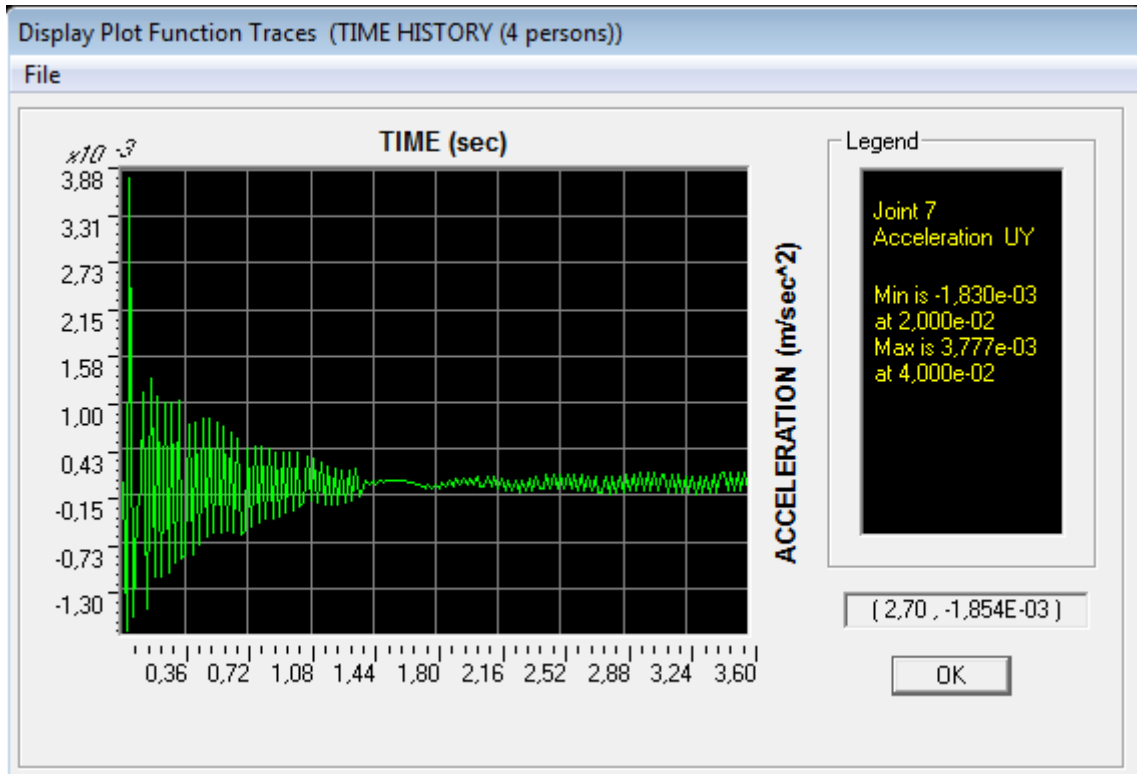

Max. acceleration in Z (vertical)		Min. acceleration in Z (vertical)	
Joint	(m/s ²)	Joint	(m/s ²)
55	0,27204988	196	-0,33976603
21	0,27204966	195	-0,33612924
253	0,26121099	197	-0,31196433
219	0,26121097	7	-0,30246906
53	0,26083456	41	-0,30246892
19	0,26083431	43	-0,29288659
57	0,2580203	9	-0,29288616
23	0,25802018	245	-0,28672156
202	0,25778347	211	-0,28672147
218	0,25559656	194	-0,28574536

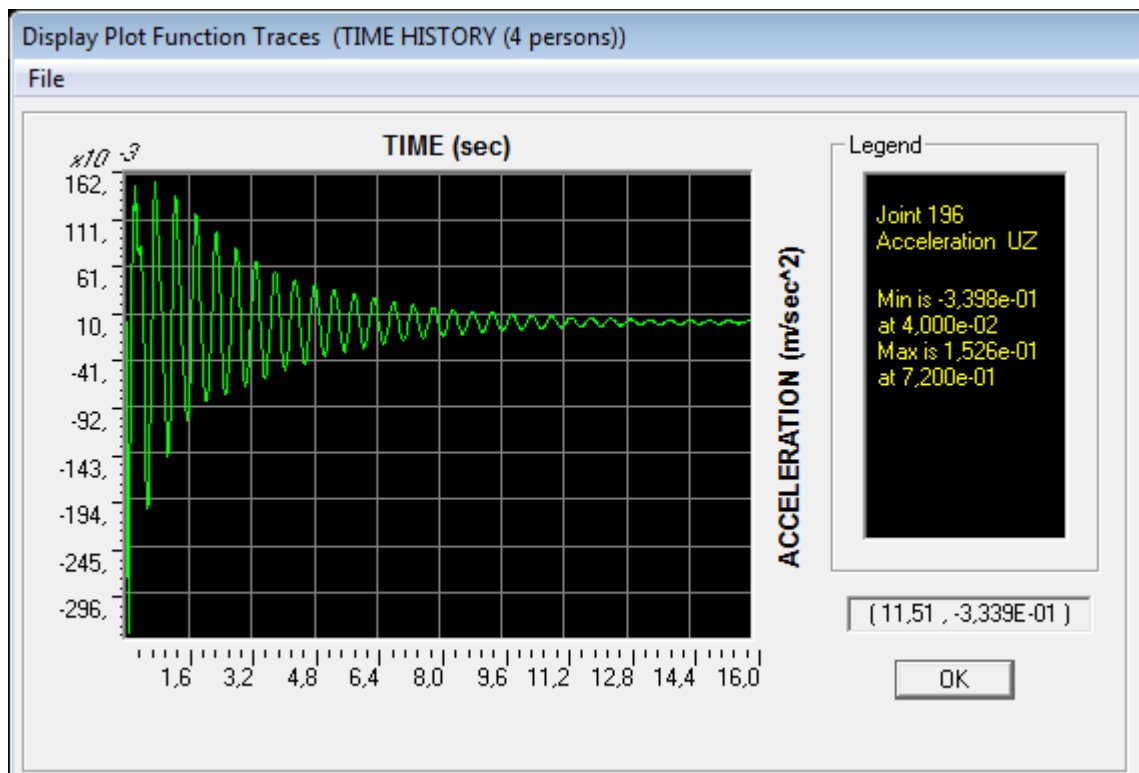

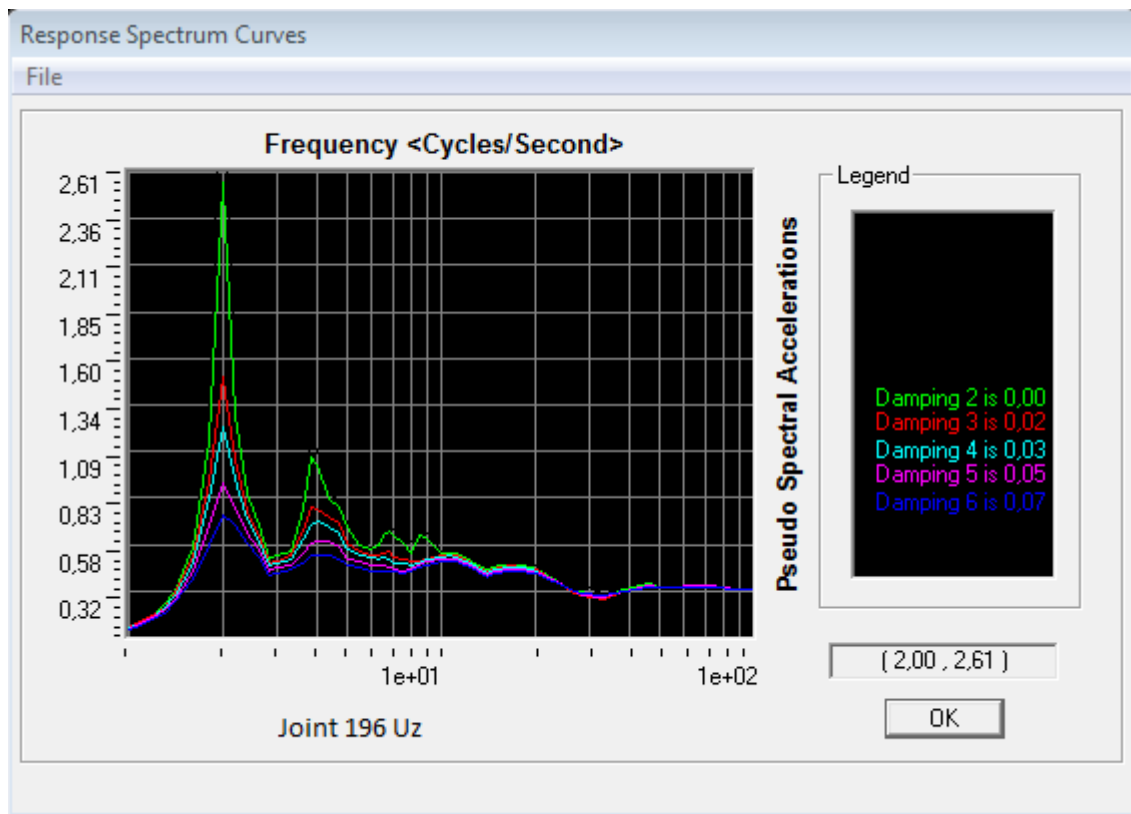

6.2.4. Acceleration results (SAP2000) of 4 persons in modal (Ritz vector)

Max. acceleration in X (longitudinal)		Min. acceleration in X (longitudinal)	
Joint	(m/s ²)	Joint	(m/s ²)
192	0,59407062	206	-0,52292593
193	0,5851228	205	-0,47526643
194	0,53894534	204	-0,41569669
195	0,50594404	203	-0,37722336
196	0,44991886	202	-0,32597533
197	0,31158282	201	-0,19288096
198	0,28106318	200	-0,16421775
206	0,16495172	193	-0,15890557
208	0,16422688	192	-0,15272893
242	0,16422645	194	-0,14926459

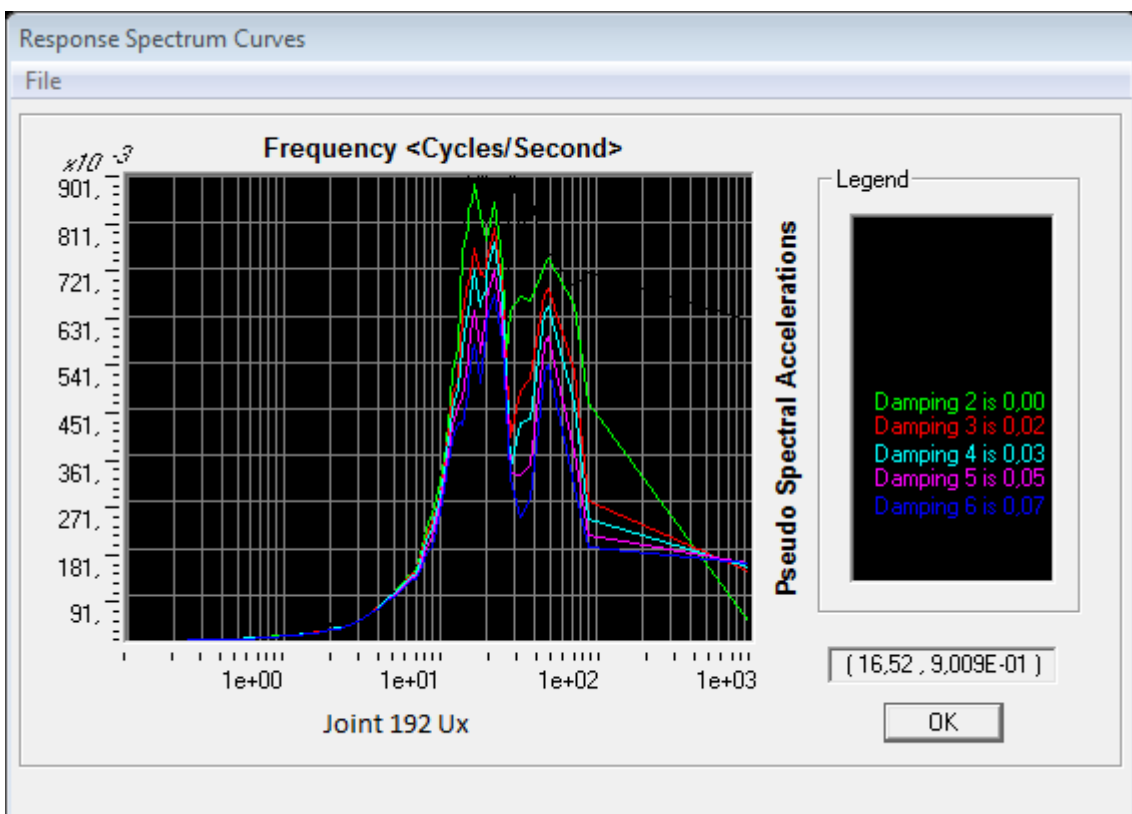
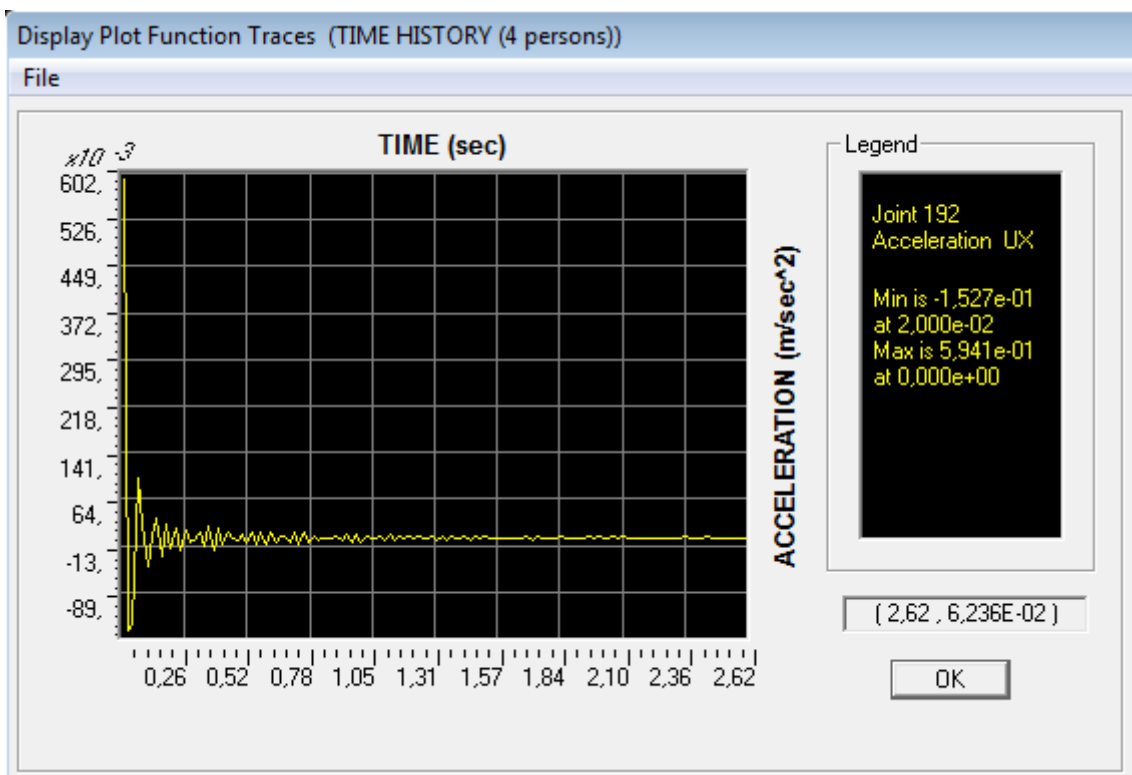

Max. acceleration in Y (horizontal)		Min. acceleration in Y (horizontal)	
Joint	(m/s ²)	Joint	(m/s ²)
47	0,27487242	13	-0,27487392
55	0,27481518	21	-0,27481639
45	0,2626433	11	-0,26264504
57	0,26094186	23	-0,26094323
53	0,19992485	19	-0,19992598
49	0,19928535	15	-0,19928664
43	0,13890867	9	-0,13891059
59	0,13847491	25	-0,13847643
224	0,10537598	258	-0,10537665
61	0,10378932	27	-0,10379092

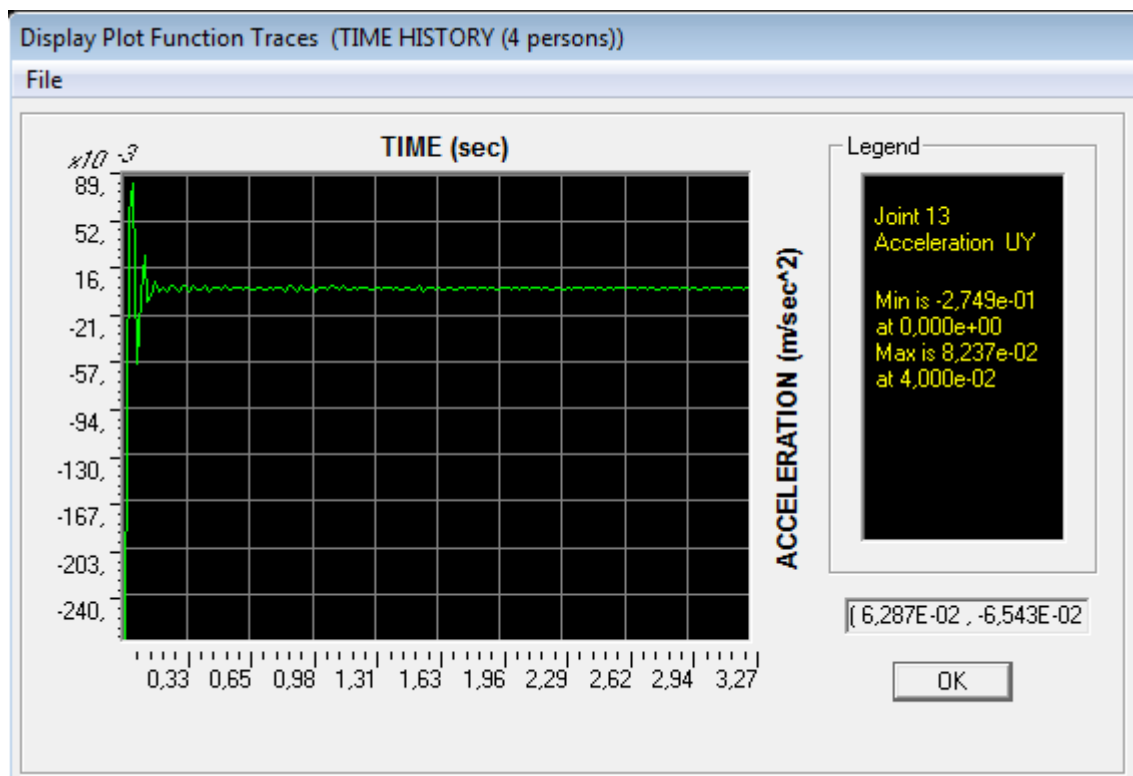

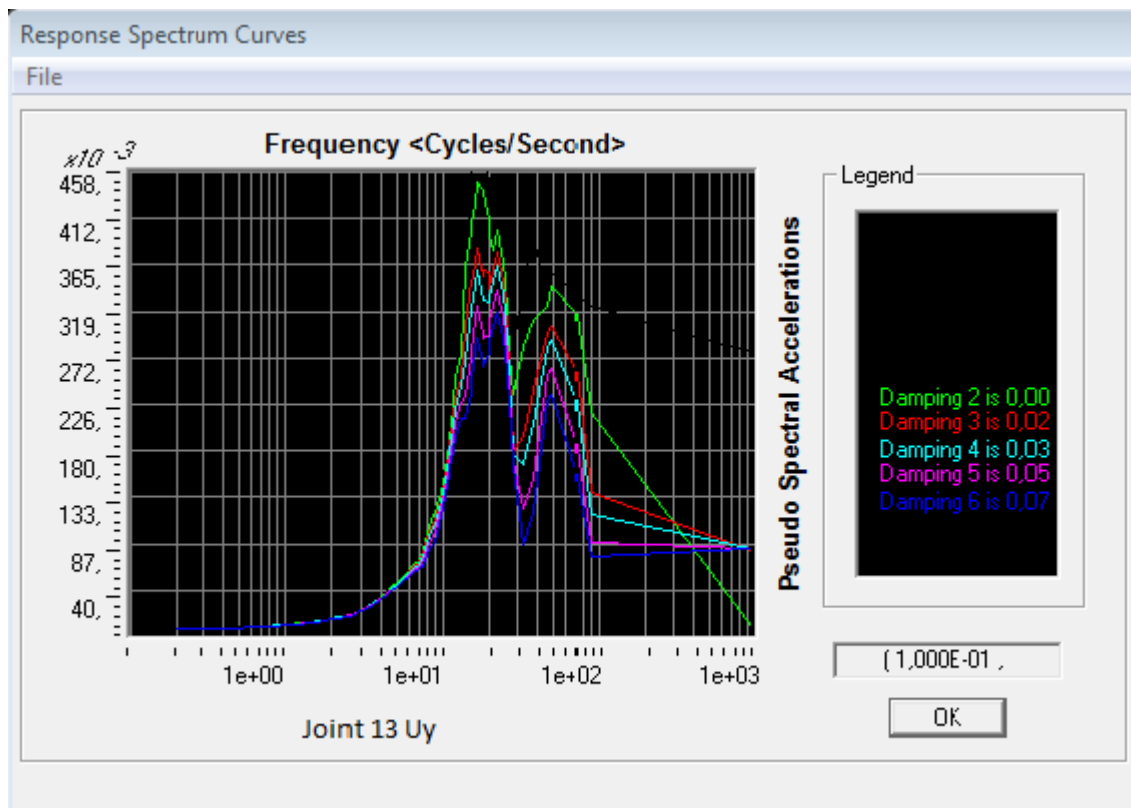

Max. acceleration in Z (vertical)		Min. acceleration in Z (vertical)	
Joint	(m/s ²)	Joint	(m/s ²)
207	0,53519155	192	-1,10494811
191	0,48366753	45	-1,08427175
202	0,34348269	11	-1,08427098
201	0,33855605	23	-1,03244006
51	0,33713679	57	-1,03243969
17	0,33713659	43	-0,96877124
216	0,33374114	9	-0,9687708
250	0,3337409	47	-0,9385127
253	0,33089146	13	-0,9385121
219	0,33089133	5	-0,93764842

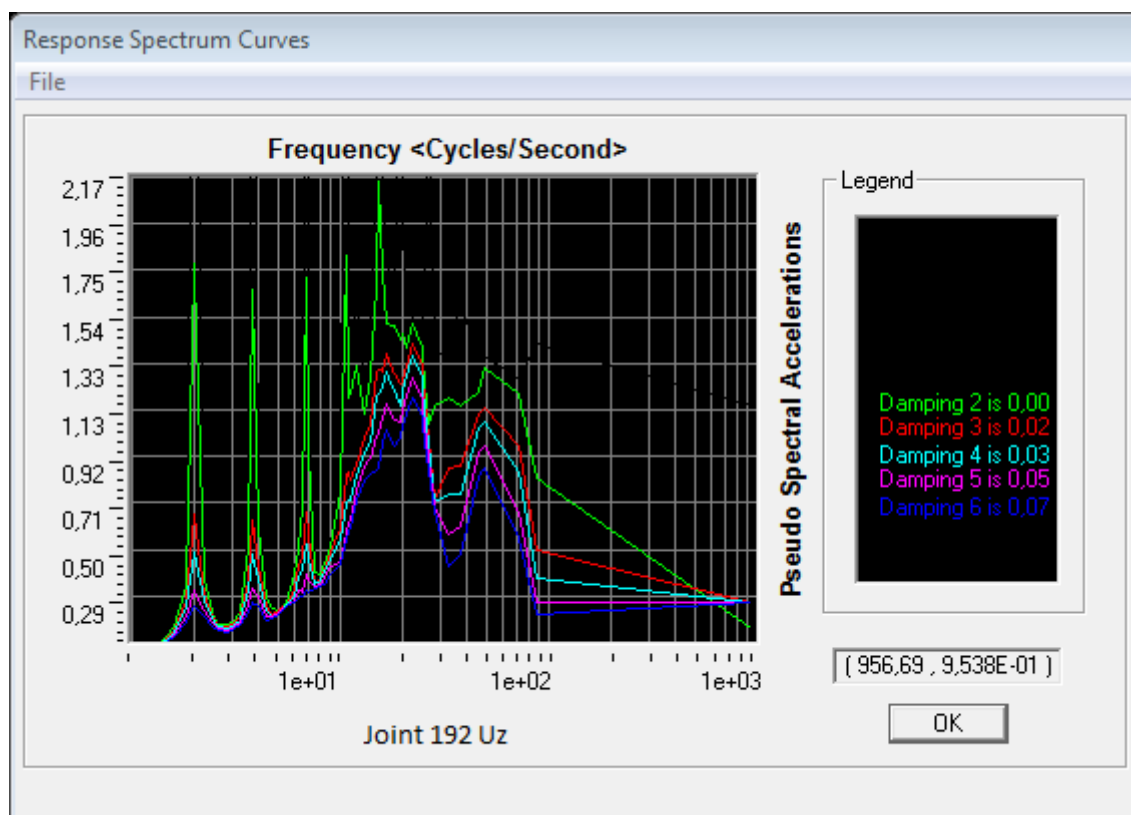
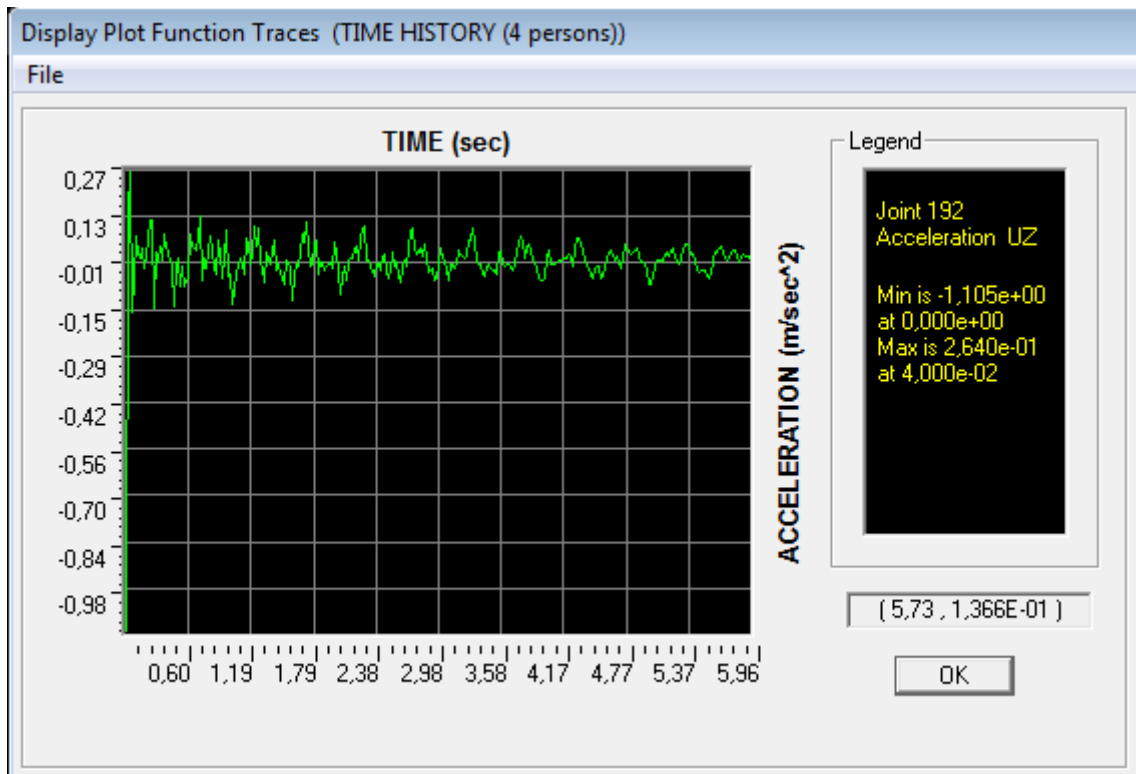

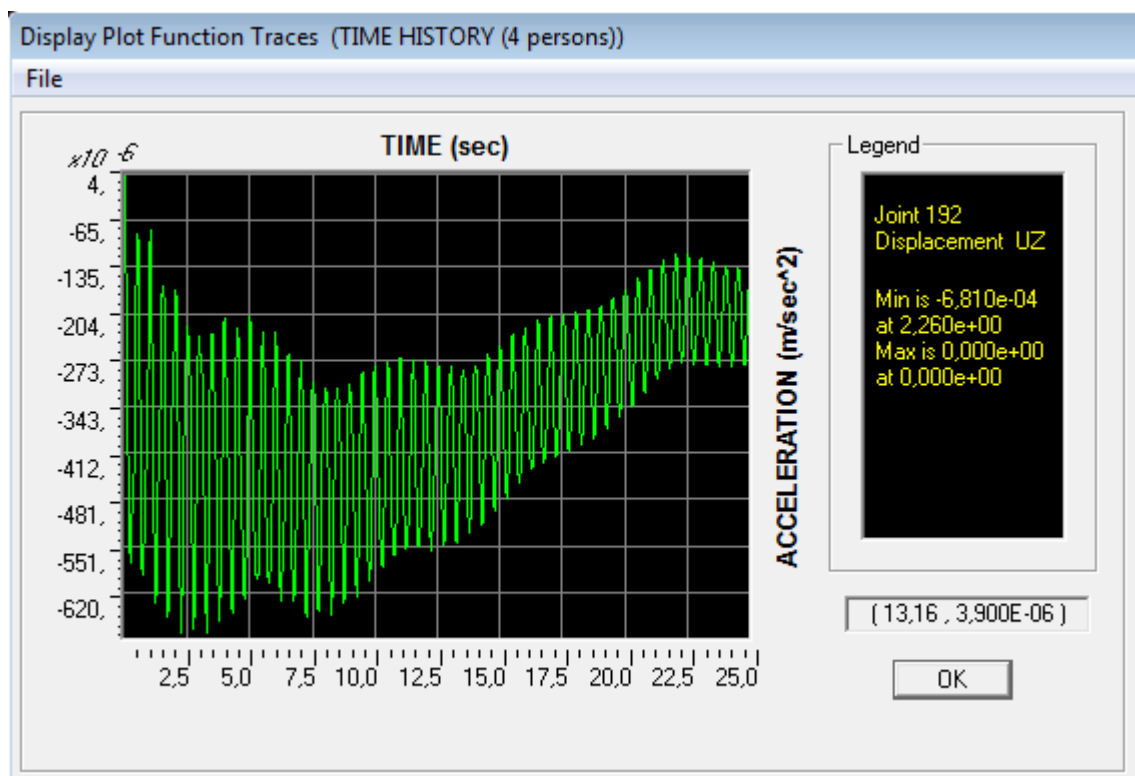

6.2.5. Acceleration results (SAP2000) of fully loaded (0,5 persons/m²) in direct integration

Max. acceleration in X (longitudinal)		Min. acceleration in X (longitudinal)	
Joint	(m/s ²)	Joint	(m/s ²)
11	0,01368707	7	-0,015515094
45	0,01368449	41	-0,015509418
13	0,01368047	9	-0,015206936
47	0,01367781	43	-0,01520091
15	0,01365462	11	-0,014874844
49	0,01365192	45	-0,014868526
9	0,01353559	5	-0,014512693
43	0,01353314	39	-0,014507654
17	0,01353234	13	-0,014401991
51	0,01352955	47	-0,014395534

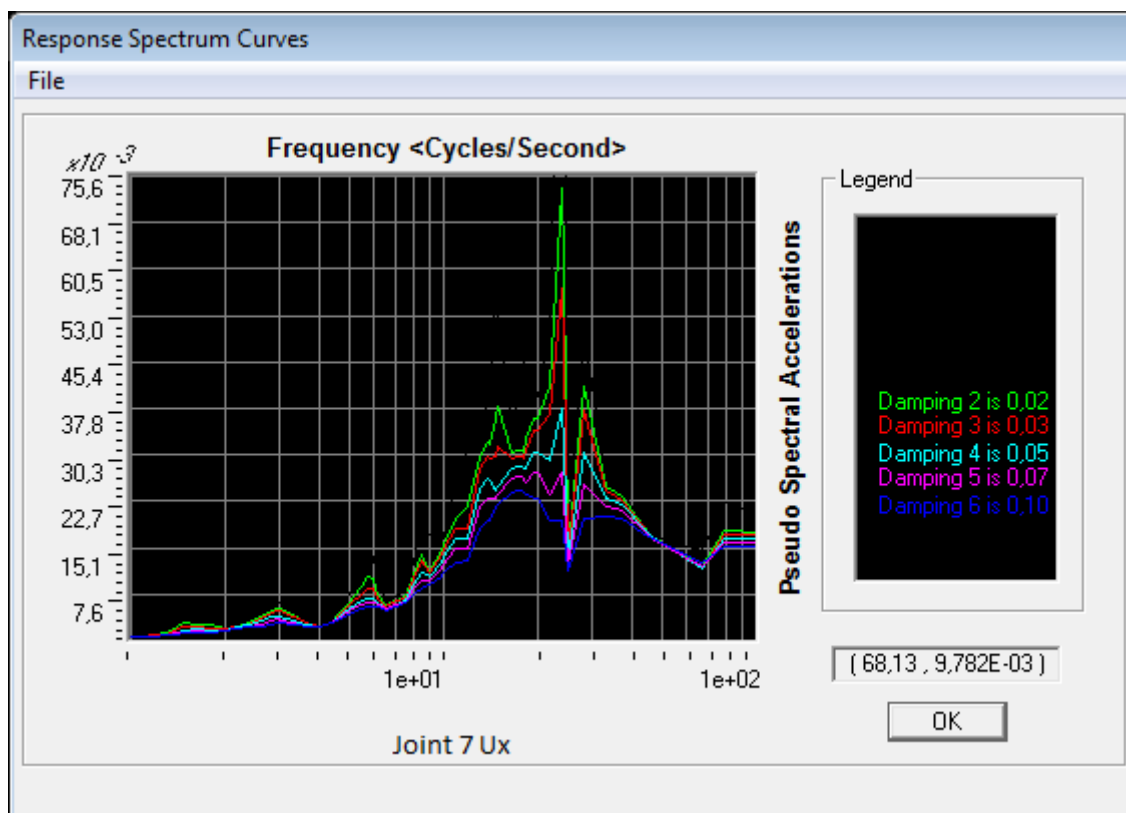
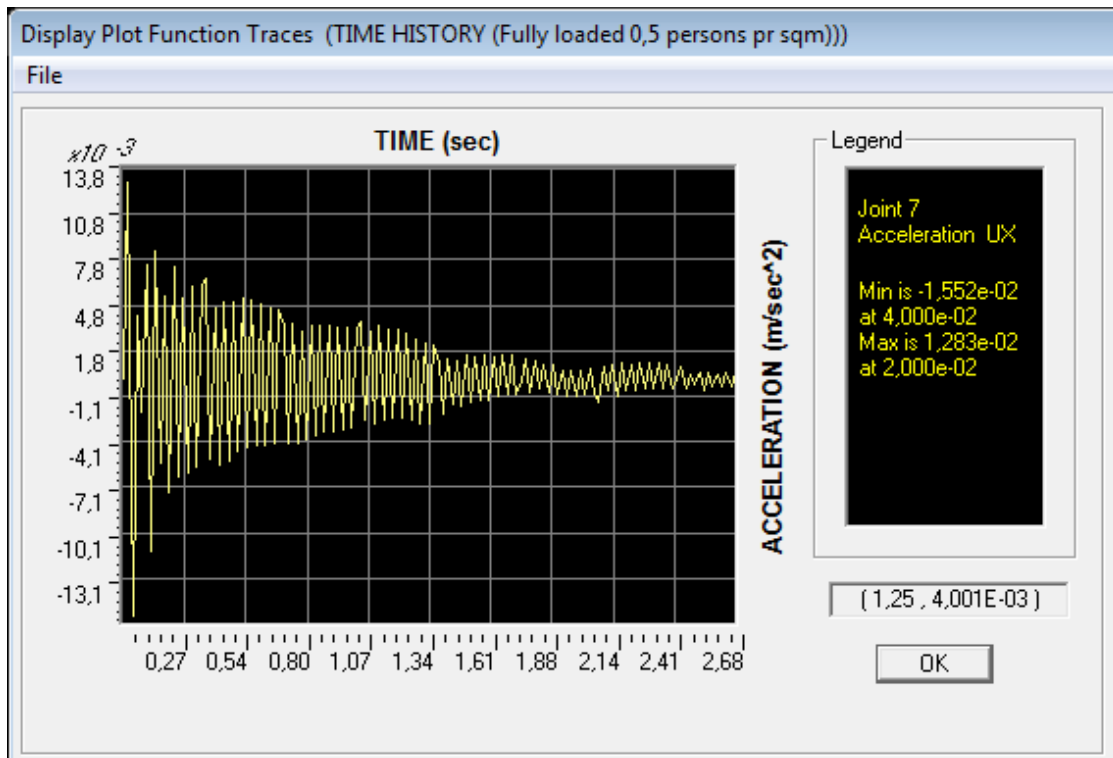

Max. acceleration in Y (horizontal)		Min. acceleration in Y (horizontal)	
Joint	(m/s ²)	Joint	(m/s ²)
7	0,00163807	41	-0,0016367
11	0,00143484	45	-0,001433789
5	0,00139088	39	-0,001389535
9	0,00132481	43	-0,001323624
13	0,00119482	47	-0,001195206
47	0,00115155	13	-0,001151709
15	0,00113922	49	-0,001139441
45	0,0011051	11	-0,001105228
49	0,0010498	15	-0,001050122
17	0,00104676	51	-0,001047108

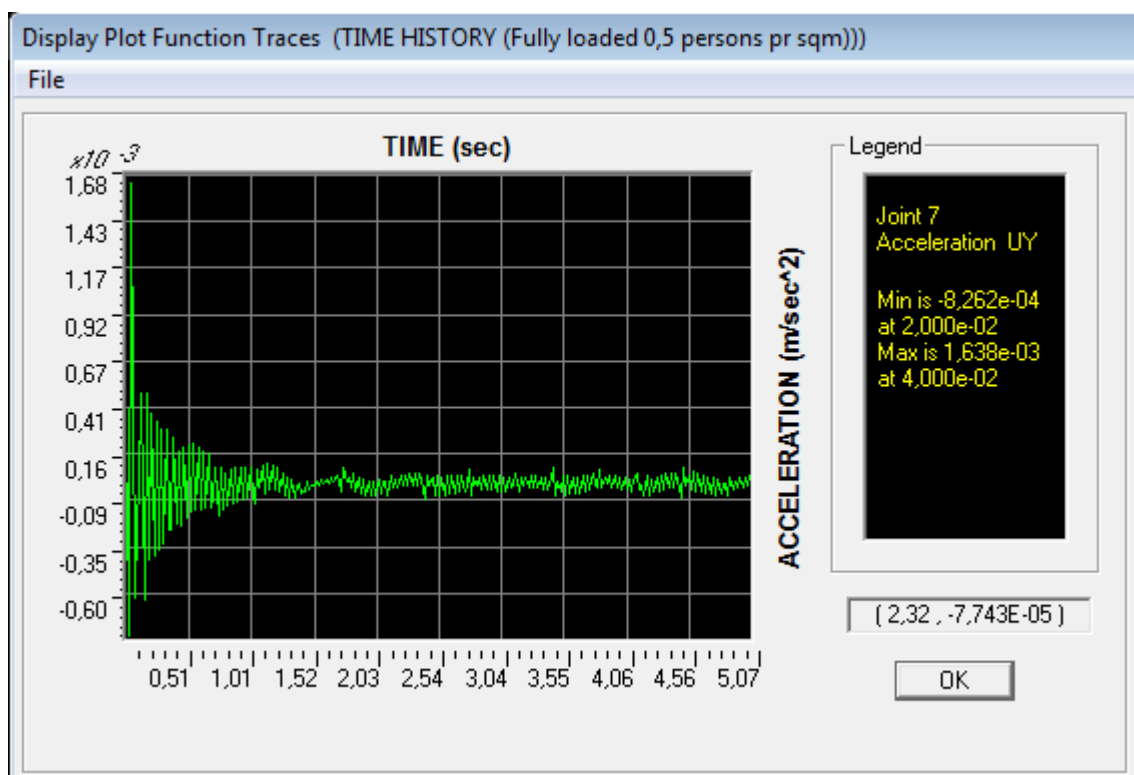

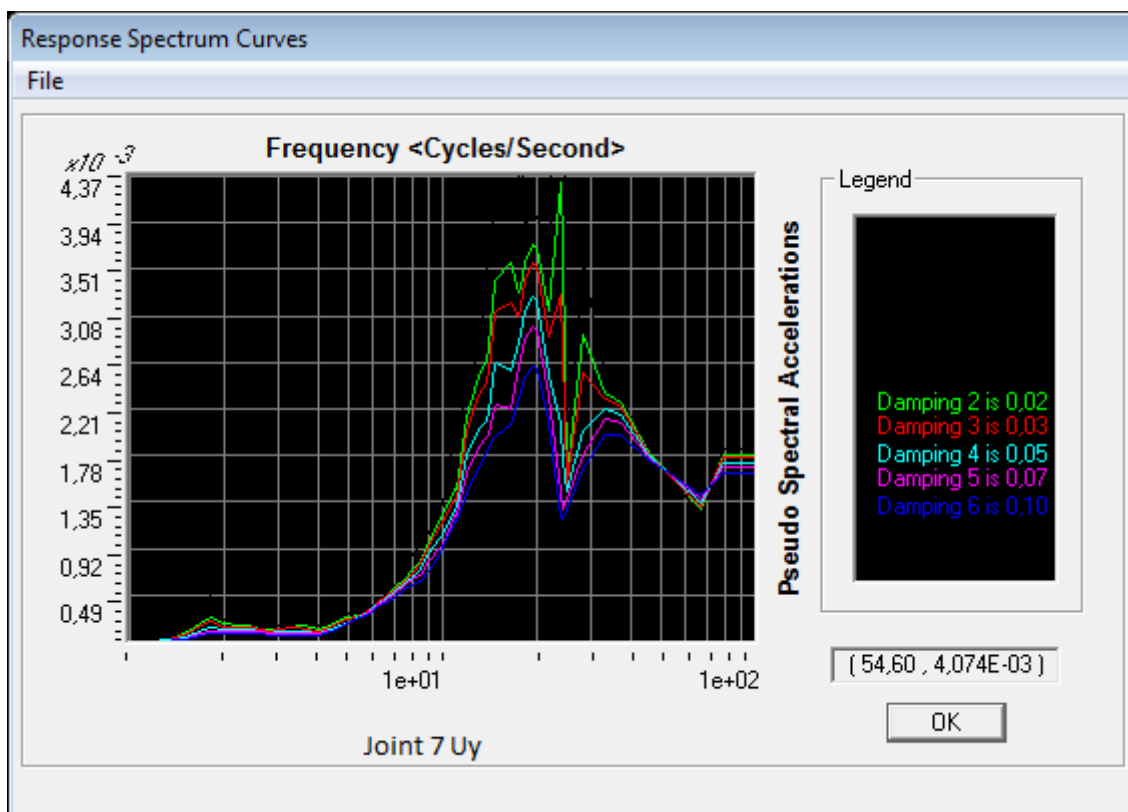

Max. acceleration in Z (vertical)		Min. acceleration in Z (vertical)	
Joint	(m/s ²)	Joint	(m/s ²)
199	0,12772058	195	-0,150387435
216	0,12768631	196	-0,148253902
250	0,1276863	197	-0,133936969
51	0,12767536	17	-0,133395348
17	0,12767534	51	-0,133395341
49	0,12546391	250	-0,132777889
15	0,12546388	216	-0,132777882
215	0,12535784	199	-0,132294429
249	0,12535782	49	-0,132257223
217	0,12519678	15	-0,132257221

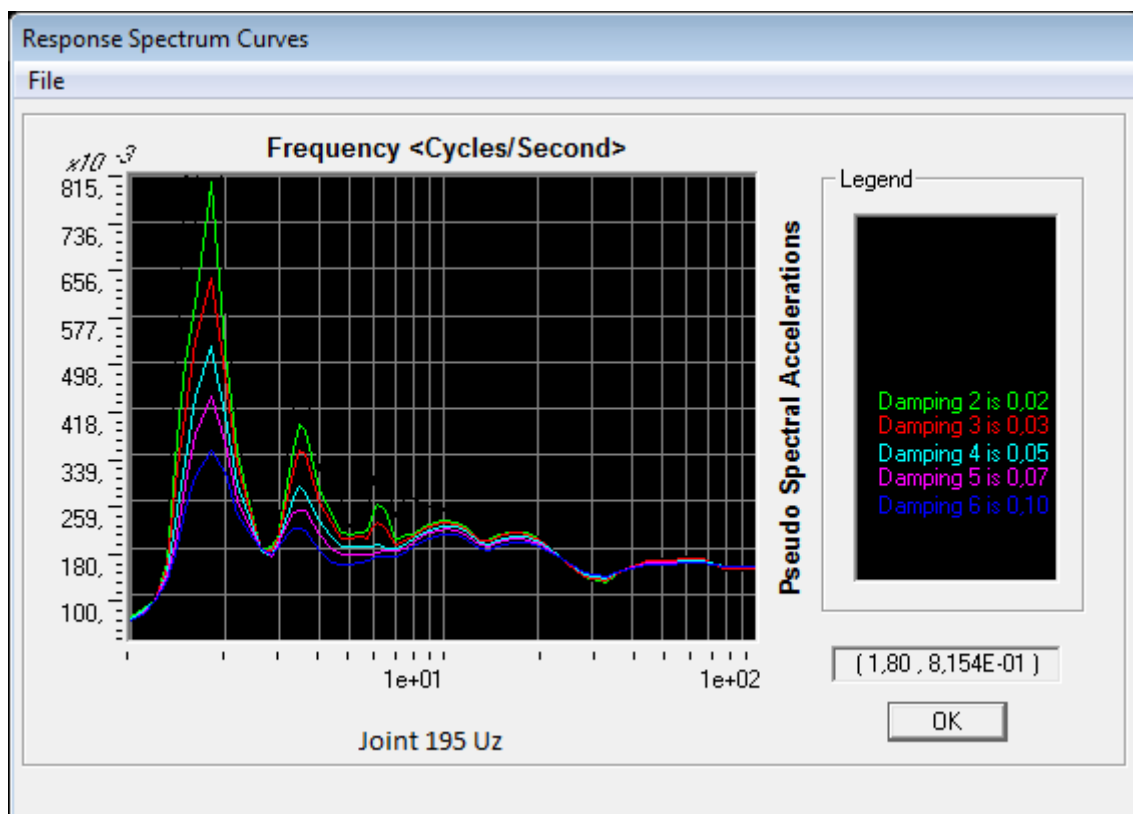
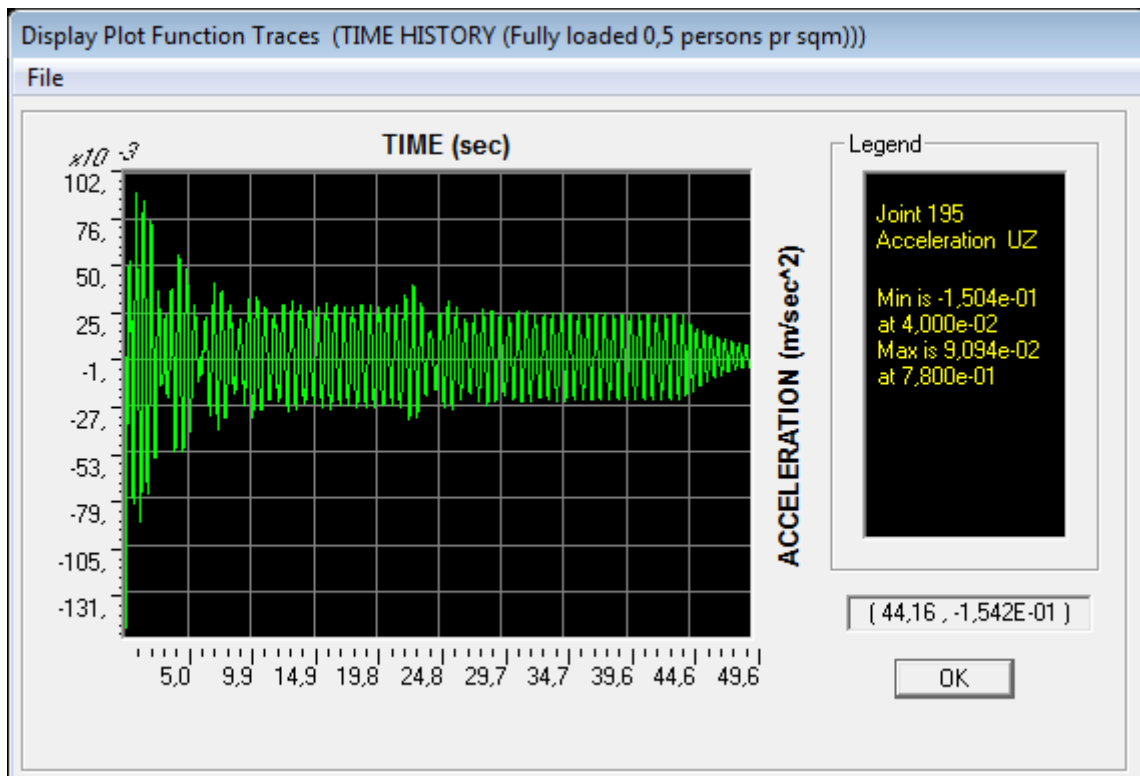

6.2.6. Acceleration results (SAP2000) of fully loaded (0,5 persons/m²) in modal (Ritz vector)

Max. acceleration in X (longitudinal)		Min. acceleration in X (longitudinal)	
Joint	(m/s ²)	Joint	(m/s ²)
193	0,04543275	207	-0,04076497
194	0,04523066	198	-0,03285053
200	0,04494322	205	-0,03277131
195	0,04201696	197	-0,03100617
201	0,04168429	204	-0,03036045
210	0,03609383	206	-0,02959934
244	0,03609369	203	-0,02664861
211	0,03587099	224	-0,02559566
245	0,03587093	258	-0,02559554
209	0,03575102	63	-0,02558613

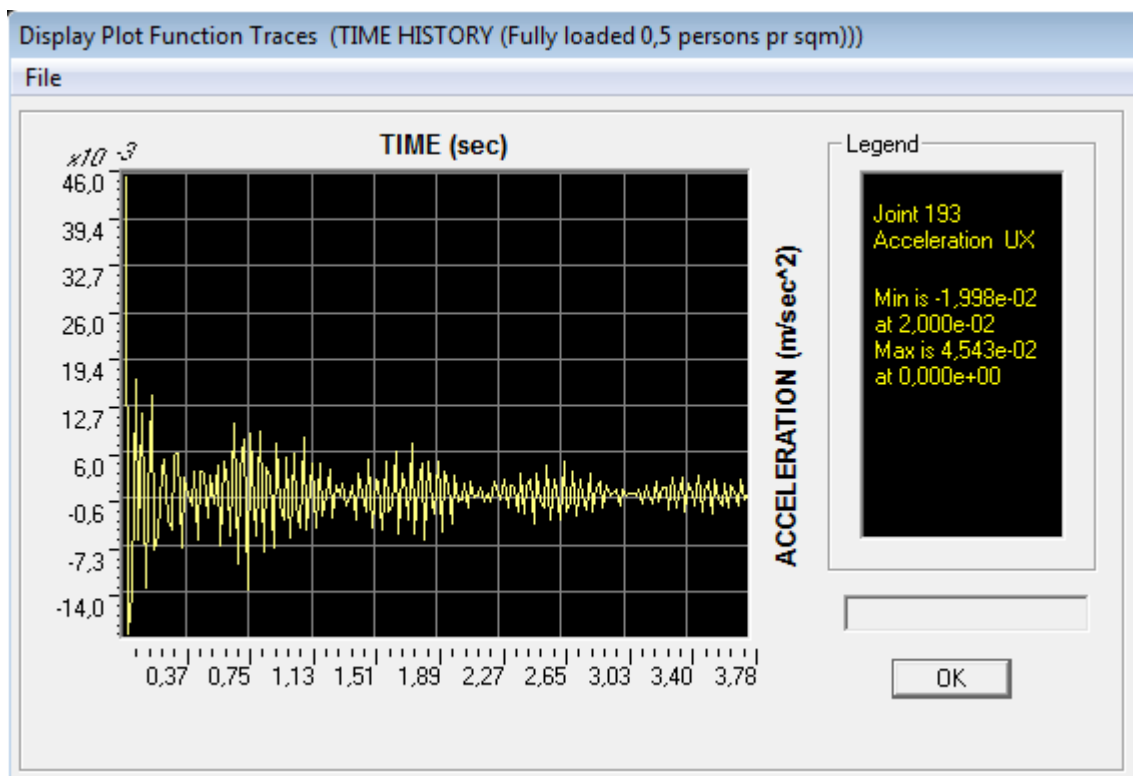

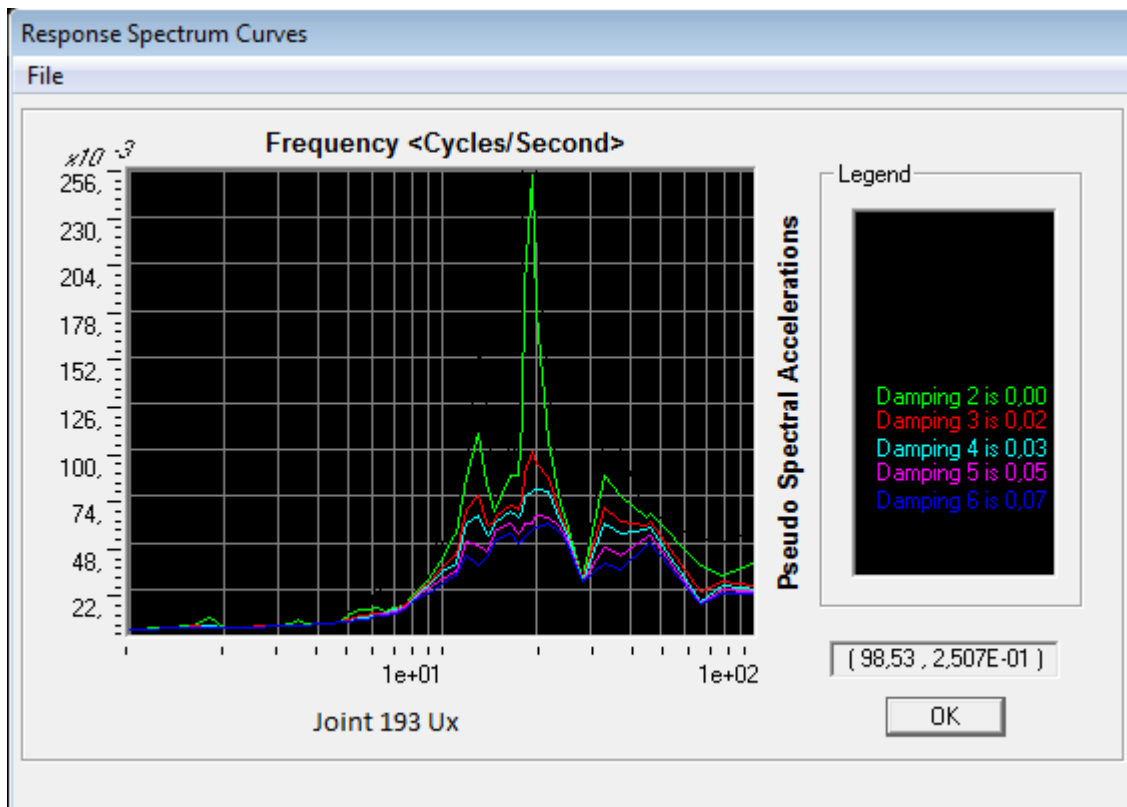

Max. acceleration in Y (horizontal)		Min. acceleration in Y (horizontal)	
Joint	(m/s ²)	Joint	(m/s ²)
55	0,21486031	5	-0,00671963
47	0,19927567	39	-0,00596359
45	0,19752965	7	-0,00962851
57	0,21464816	41	-0,00822099
53	0,20283265	43	-0,01033026
49	0,22231401	9	-0,01488664
13	0,19927621	45	-0,02189375
21	0,21486027	11	-0,02929934
15	0,22231442	3	-0,00190657
19	0,20283257	37	-0,00199727

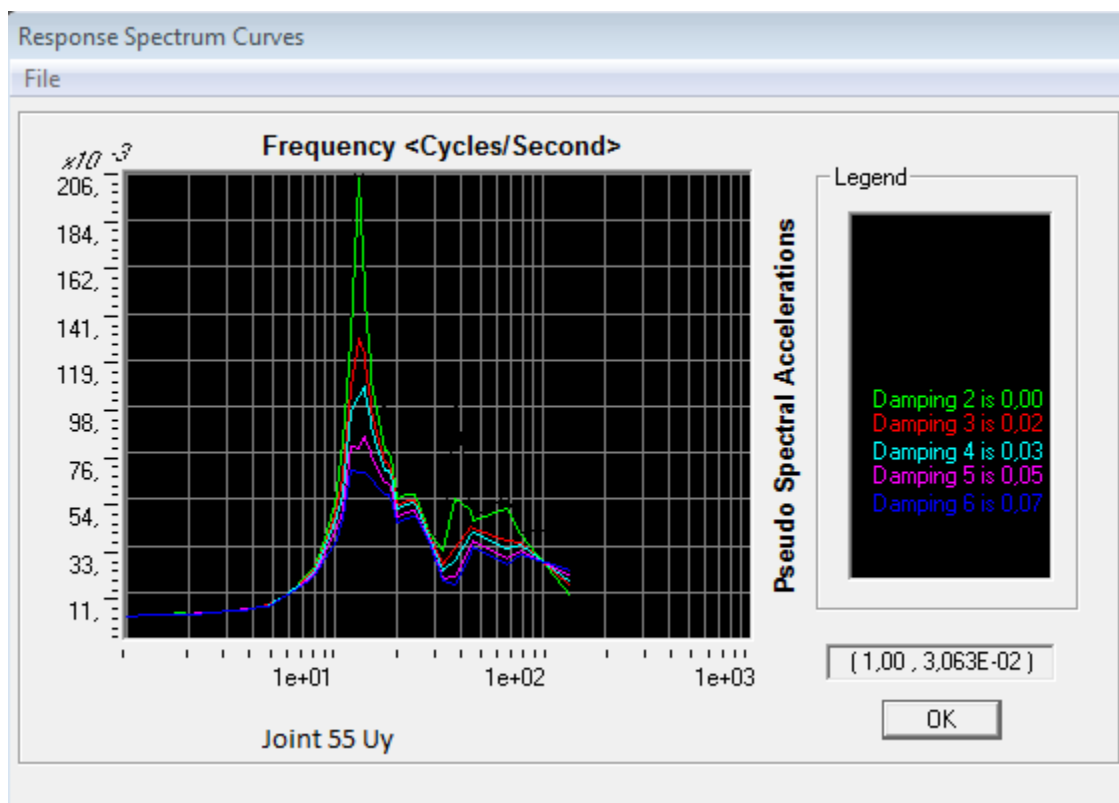
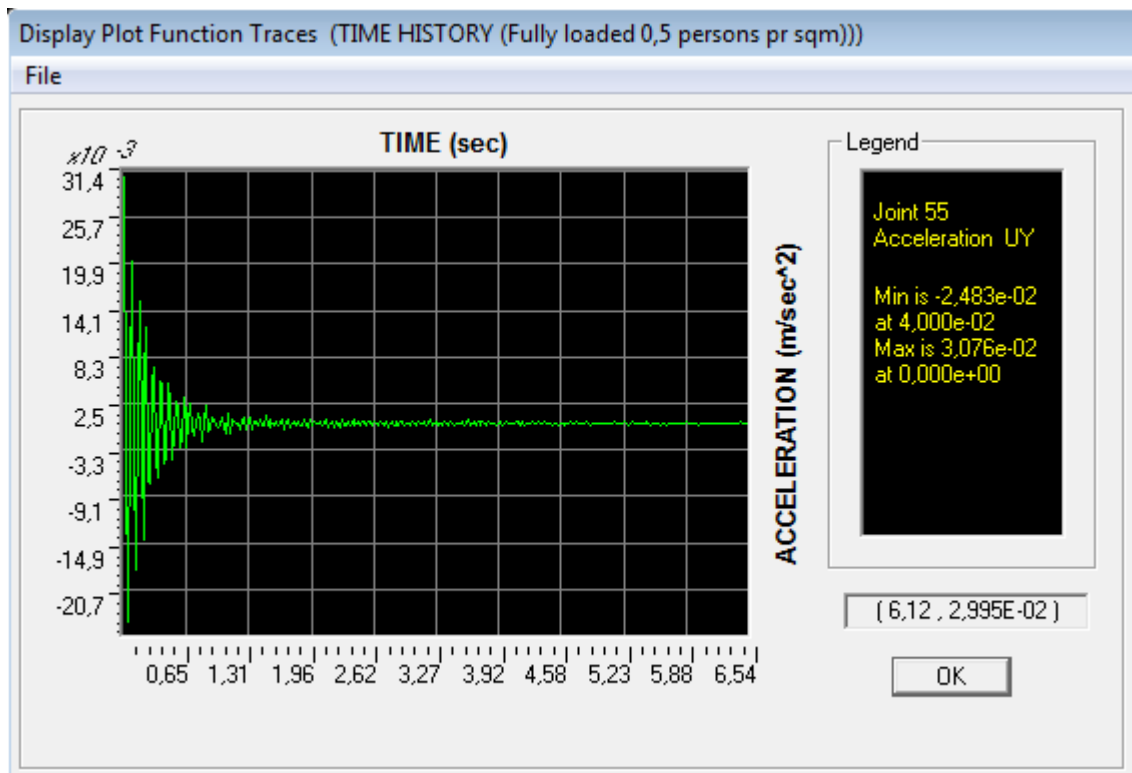

Max. acceleration in Z (vertical)		Min. acceleration in Z (vertical)	
Joint	(m/s ²)	Joint	(m/s ²)
15	0,22231442	5	-0,37840861
49	0,22231401	39	-0,37840815
198	0,21653779	7	-0,36873059
197	0,21609538	41	-0,36873043
199	0,2148949	43	-0,3679749
55	0,21486031	9	-0,3679747
21	0,21486027	45	-0,36557986
23	0,2146482	11	-0,36557947
57	0,21464816	3	-0,36460968
3	0,21292525	37	-0,36460929

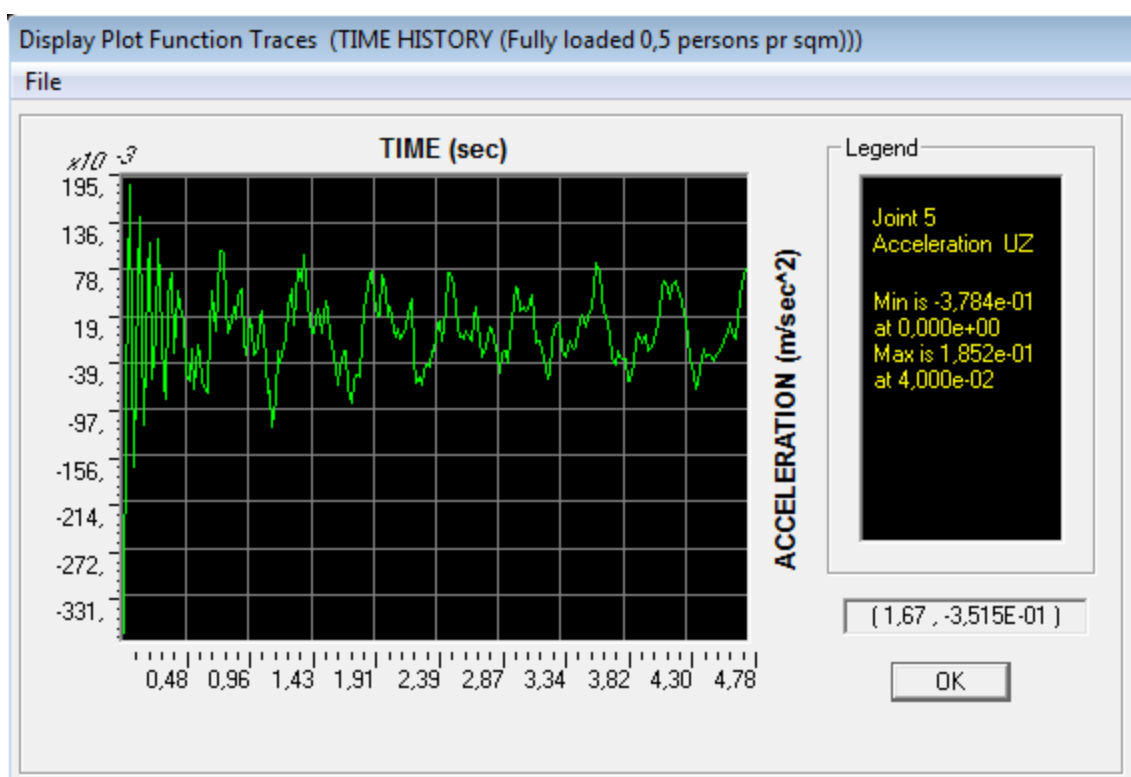

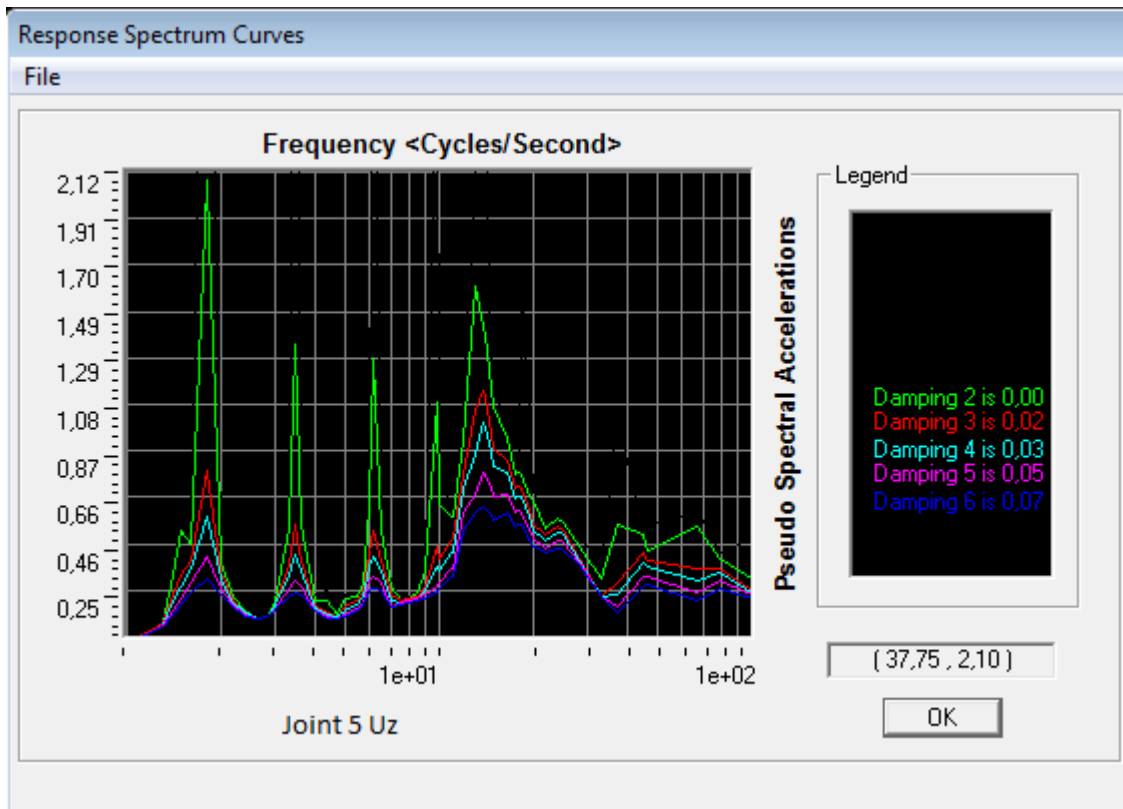

Modes of fully loaded (1 persons/m²) in direct integration

OutputCase	StepType	StepNum	Period	Frequency	CircFreq	Eigenvalue
MODAL	Mode	1	0,47346237	2,11210025	13,2707173	176,111937
MODAL	Mode	2	0,38799139	2,57737676	16,1941358	262,250034
MODAL	Mode	3	0,26138577	3,82576301	24,0379779	577,824382
MODAL	Mode	4	0,21177509	4,72199072	29,6691427	880,258028
MODAL	Mode	5	0,15764695	6,3432881	39,8560546	1588,50509
MODAL	Mode	6	0,10463197	9,55730793	60,0503367	3606,04294
MODAL	Mode	7	0,10453807	9,56589353	60,1042817	3612,52467
MODAL	Mode	8	0,09672025	10,339096	64,9624562	4220,12072
MODAL	Mode	9	0,07754682	12,895436	81,024414	6564,95567
MODAL	Mode	10	0,07093172	14,0980656	88,5807588	7846,55084
MODAL	Mode	11	0,06181572	16,1771136	101,643803	10331,4626
MODAL	Mode	12	0,05036634	19,854528	124,749679	15562,4823
MODAL	Mode	13	0,04929214	20,2872119	127,468312	16248,1705
MODAL	Mode	14	0,04702276	21,2662976	133,620088	17854,328
MODAL	Mode	15	0,03381255	29,5748179	185,824061	34530,5818
MODAL	Mode	16	0,0330964	30,2147653	189,84497	36041,1125
MODAL	Mode	17	0,02576352	38,8145764	243,879176	59477,0526
MODAL	Mode	18	0,01695985	58,9627937	370,474159	137251,102
MODAL	Mode	19	0,01612055	62,0326217	389,762457	151914,773
MODAL	Mode	20	0,00771497	129,618054	814,414255	663270,578

6.2.7. Acceleration results (SAP2000) of fully loaded (1 persons/m²) in direct integration

Max. acceleration in X (longitudinal)		Min. acceleration in X (longitudinal)	
Joint	(m/s ²)	Joint	(m/s ²)
207	0,06661988	11	-0,05457523
27	0,05782624	45	-0,05456191
61	0,05782121	13	-0,05445748
25	0,05781226	47	-0,05444364
59	0,05780685	15	-0,05364175
29	0,05773029	49	-0,05362763
63	0,05772576	9	-0,05353553
31	0,05758093	43	-0,05352317
65	0,05757709	197	-0,05214919
23	0,05755386	17	-0,05214837

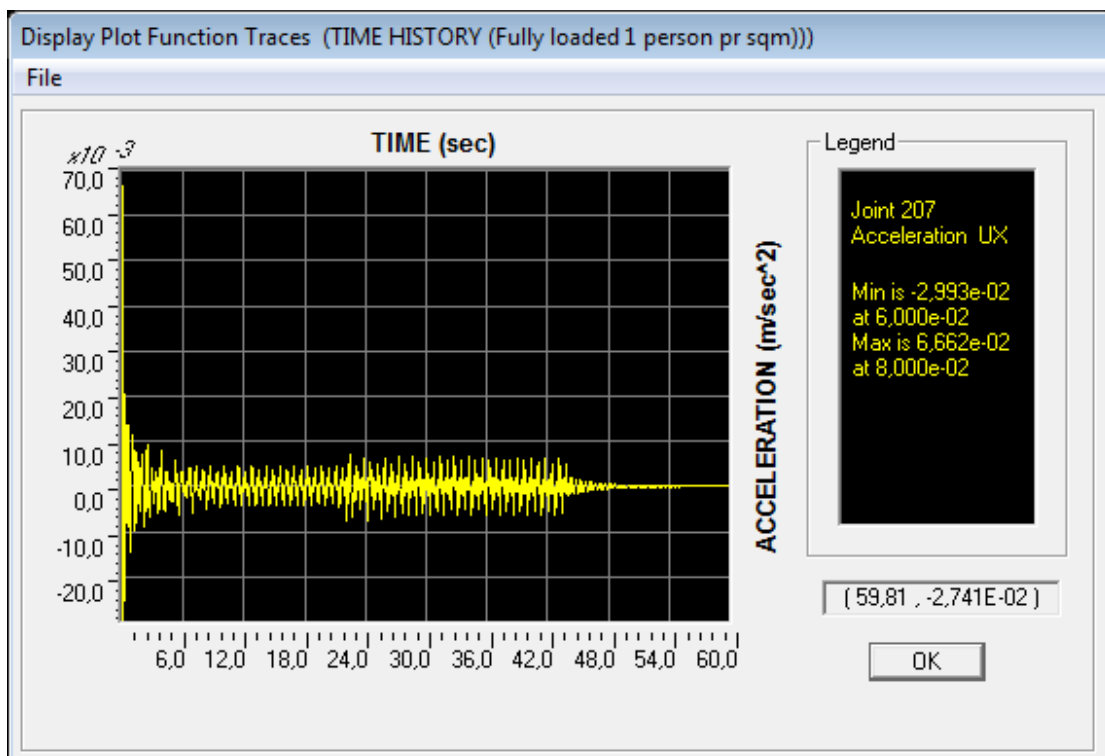

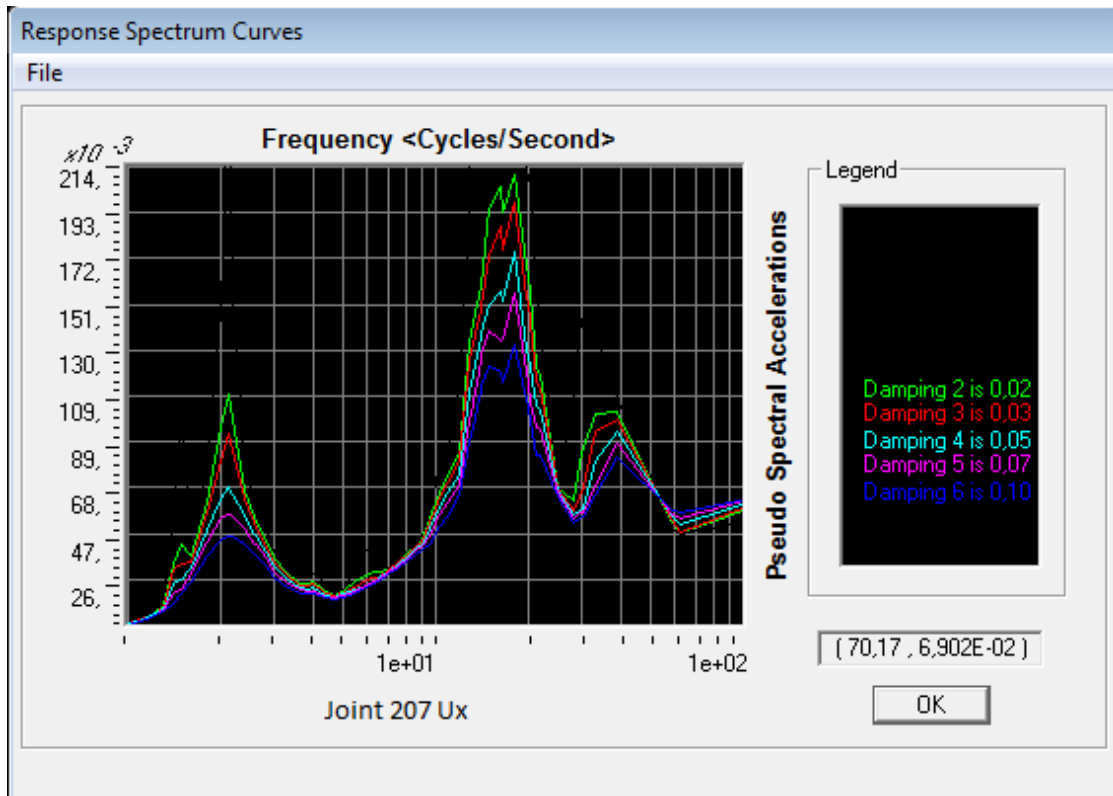

Max. acceleration in Y (horizontal)		Min. acceleration in Y (horizontal)	
Joint	(m/s ²)	Joint	(m/s ²)
9	0,0023912	43	-0,0023934
5	0,0023548	39	-0,00235904
39	0,00223649	5	-0,00223502
7	0,00205115	41	-0,00205464
41	0,00185659	7	-0,00185626
37	0,00185514	3	-0,00184999
47	0,00173337	13	-0,00173145
49	0,00172233	15	-0,00172146
249	0,00159368	215	-0,00159468
45	0,0015841	11	-0,00158184

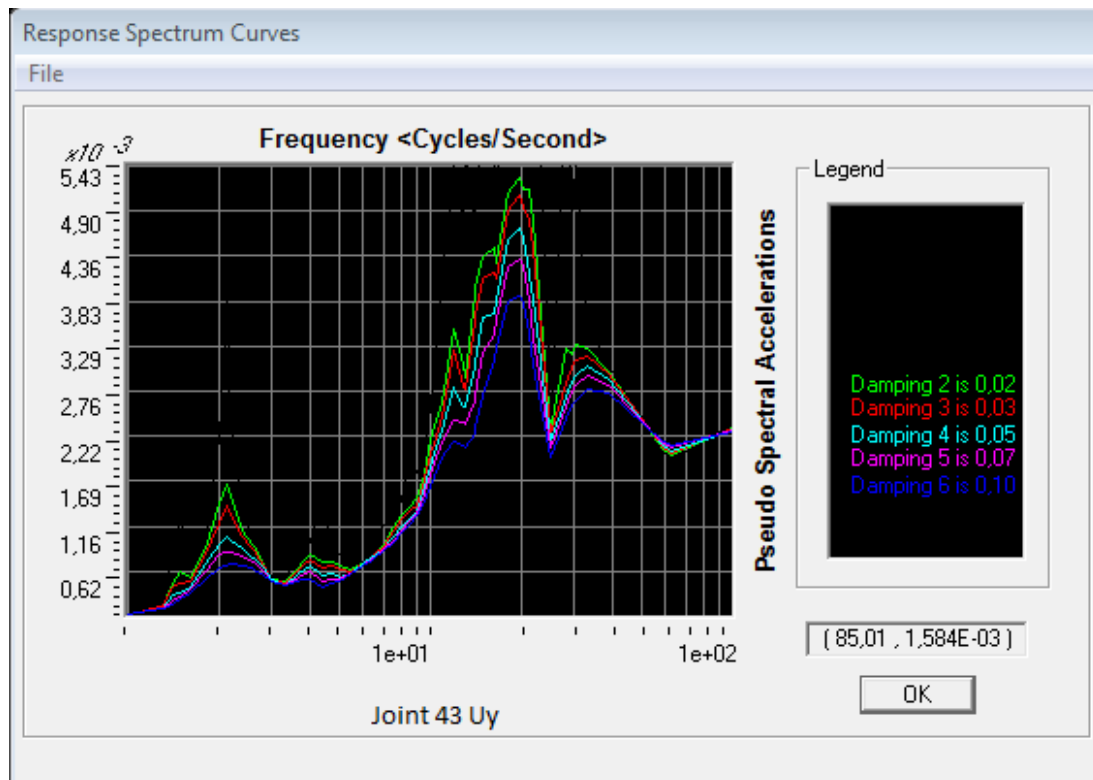
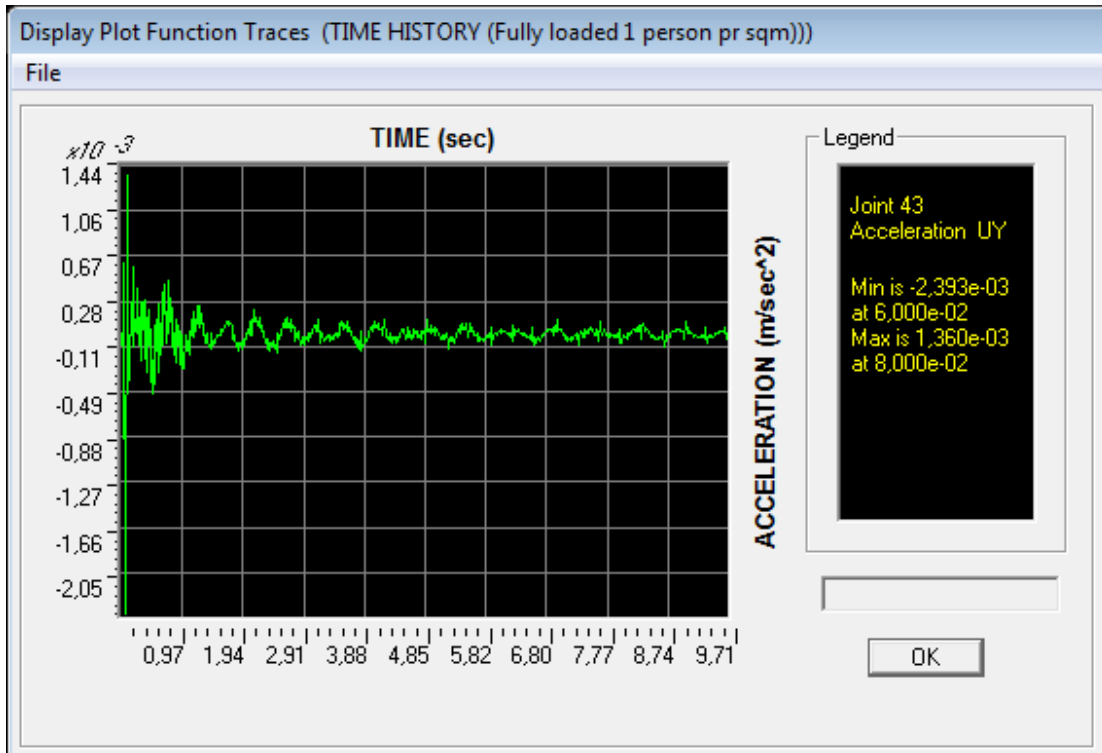

Max. acceleration in Z (vertical)		Min. acceleration in Z (vertical)	
Joint	(m/s ²)	Joint	(m/s ²)
202	0,33288757	195	-0,47077732
198	0,33228888	196	-0,46689191
253	0,33184827	197	-0,42201811
219	0,33184818	194	-0,41551938
49	0,32955176	7	-0,38206929
15	0,32955165	41	-0,38206913
215	0,32943711	198	-0,3705626
249	0,32943709	43	-0,37007044
23	0,32697867	9	-0,37006989
57	0,32697846	245	-0,36950631

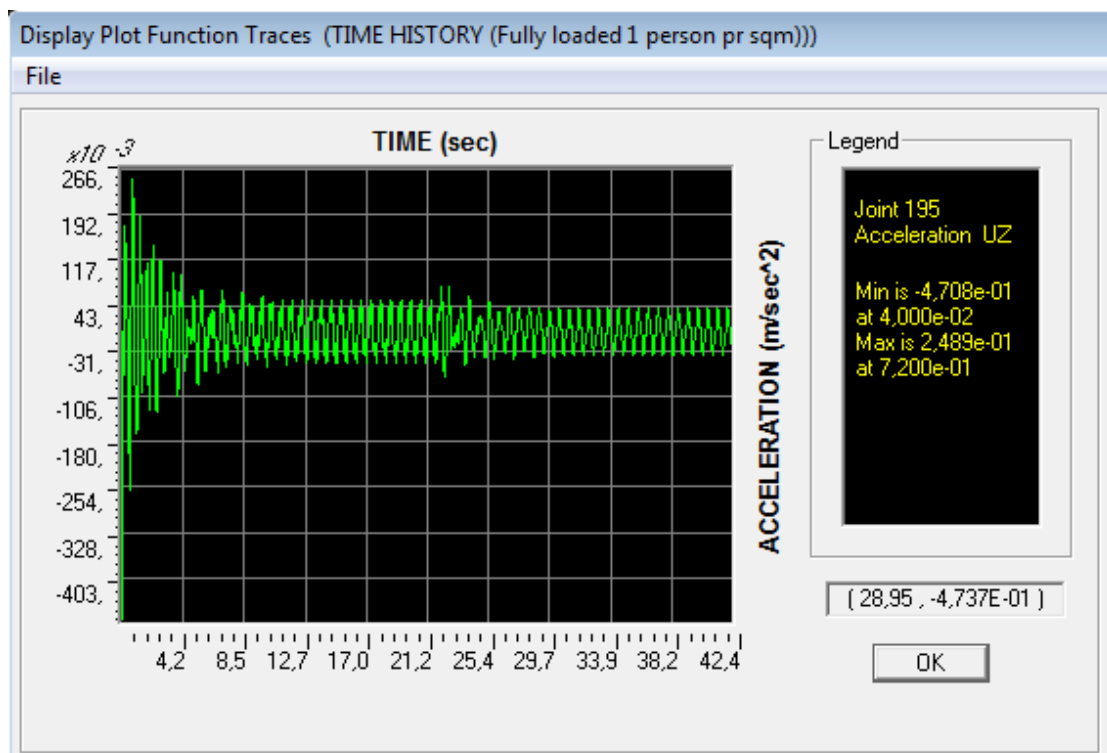

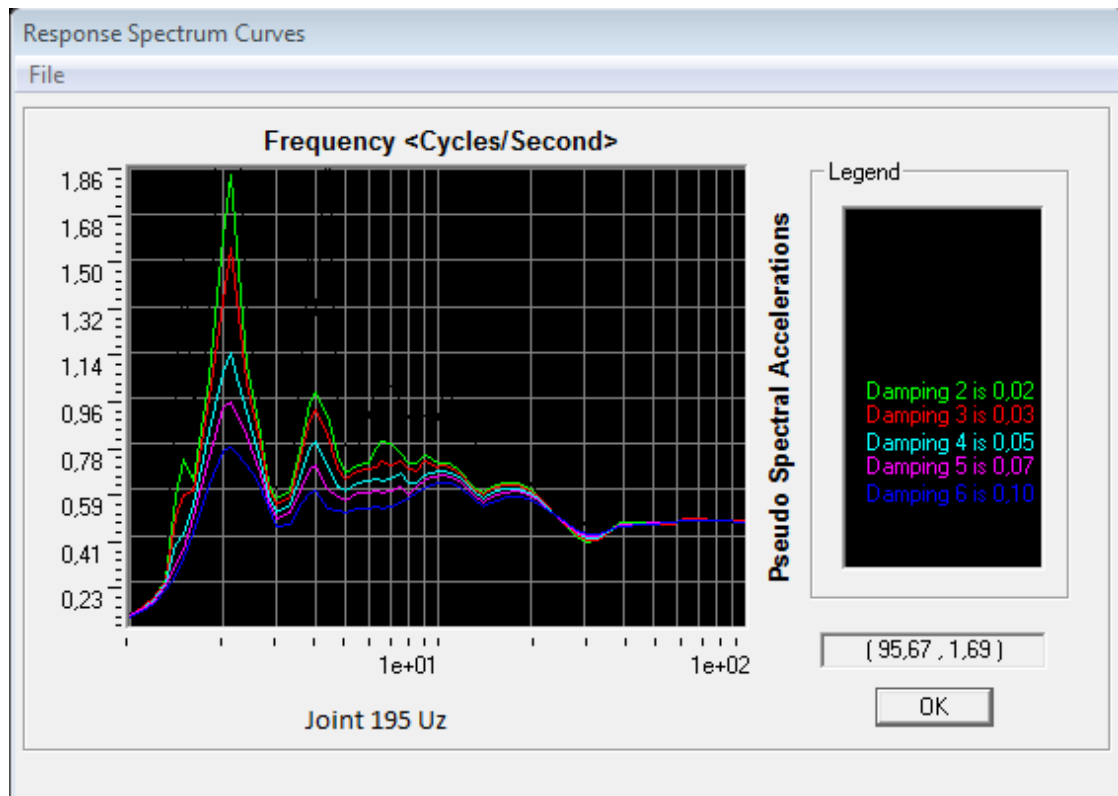

6.2.8. Acceleration results (SAP2000) of fully loaded (1 persons/m²) in modal (Ritz vector)

Max. acceleration in X (longitudinal)		Min. acceleration in X (longitudinal)	
Joint	(m/s ²)	Joint	(m/s ²)
191	0,36604137	191	-0,31659986
207	0,30801498	207	-0,28287235
195	0,26109326	195	-0,19939199
196	0,25333824	196	-0,19504778
194	0,25188989	194	-0,19242512
197	0,2268157	197	-0,17721214
246	0,21774684	246	-0,17315677
212	0,21774609	212	-0,17315579
211	0,21472616	245	-0,17249202
245	0,21472612	211	-0,17249174

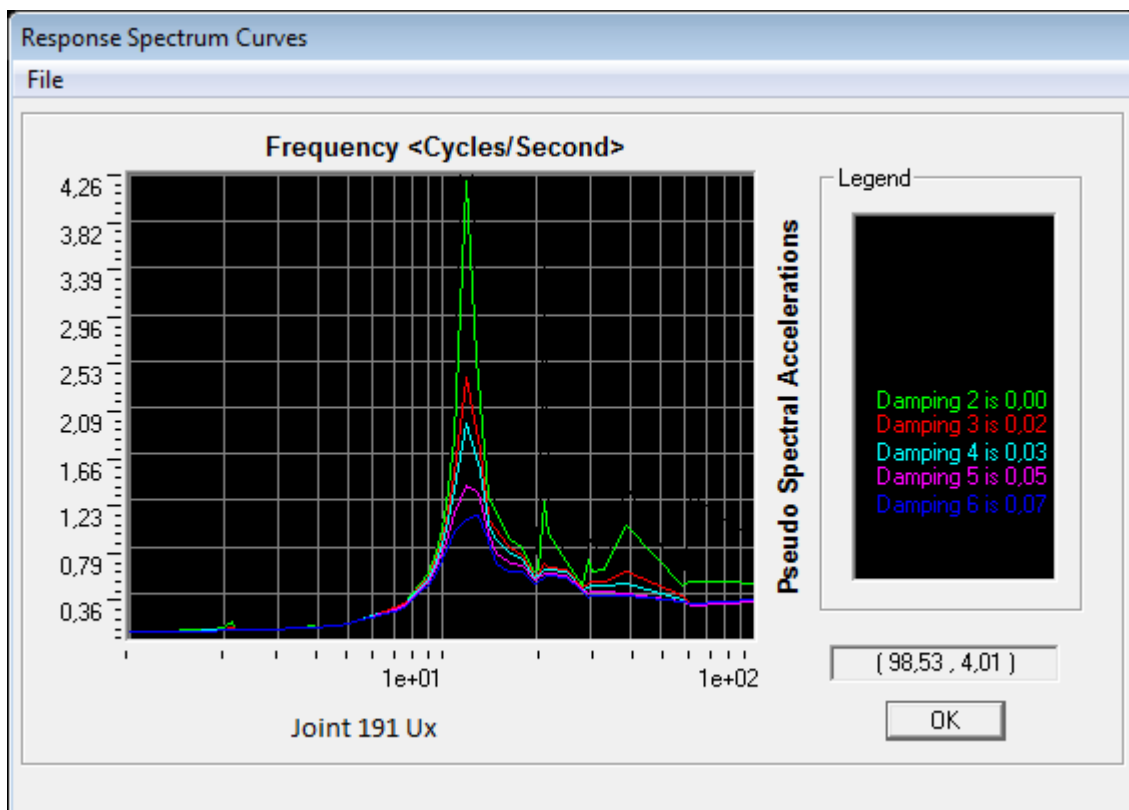
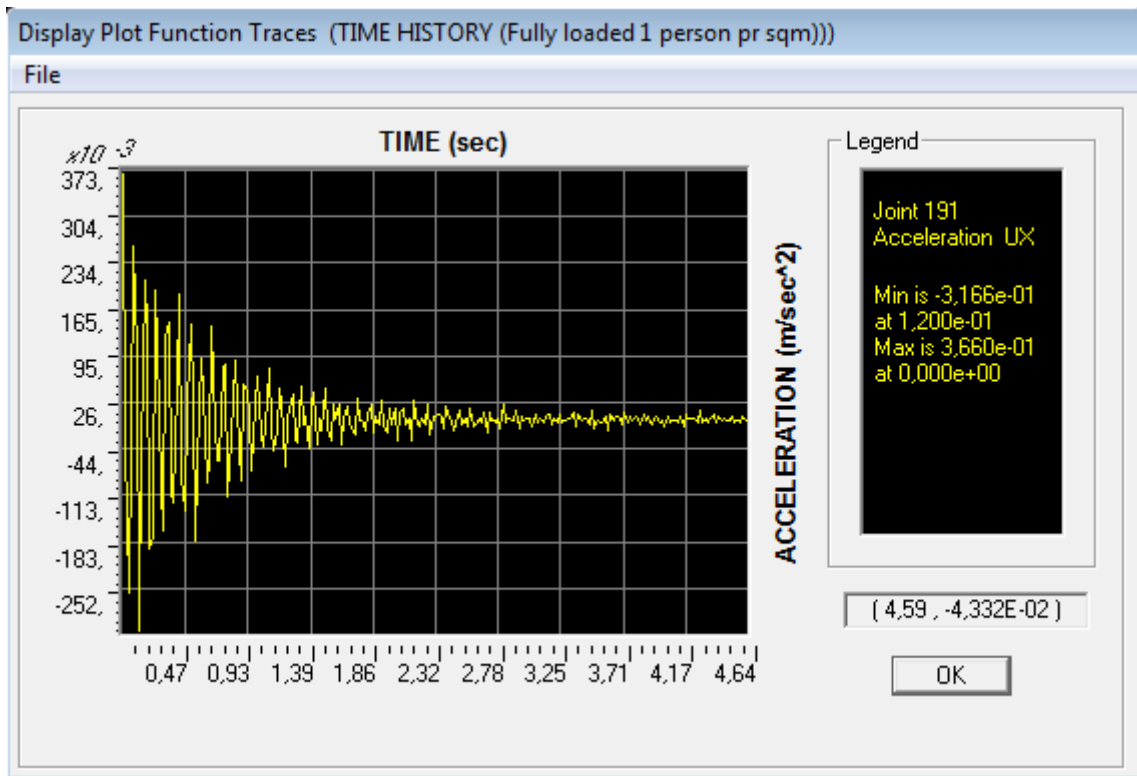

Max. acceleration in Y (horizontal)		Min. acceleration in Y (horizontal)	
Joint	(m/s ²)	Joint	(m/s ²)
258	0,03629975	224	-0,03629906
242	0,03559797	208	-0,035597
3	0,03064776	37	-0,03065209
5	0,03043727	39	-0,03044367
224	0,02951614	258	-0,02951697
31	0,02784033	65	-0,02784314
208	0,02621272	242	-0,0262139
29	0,02327594	63	-0,0232795
37	0,02037222	3	-0,02036882
65	0,01978204	31	-0,01978009

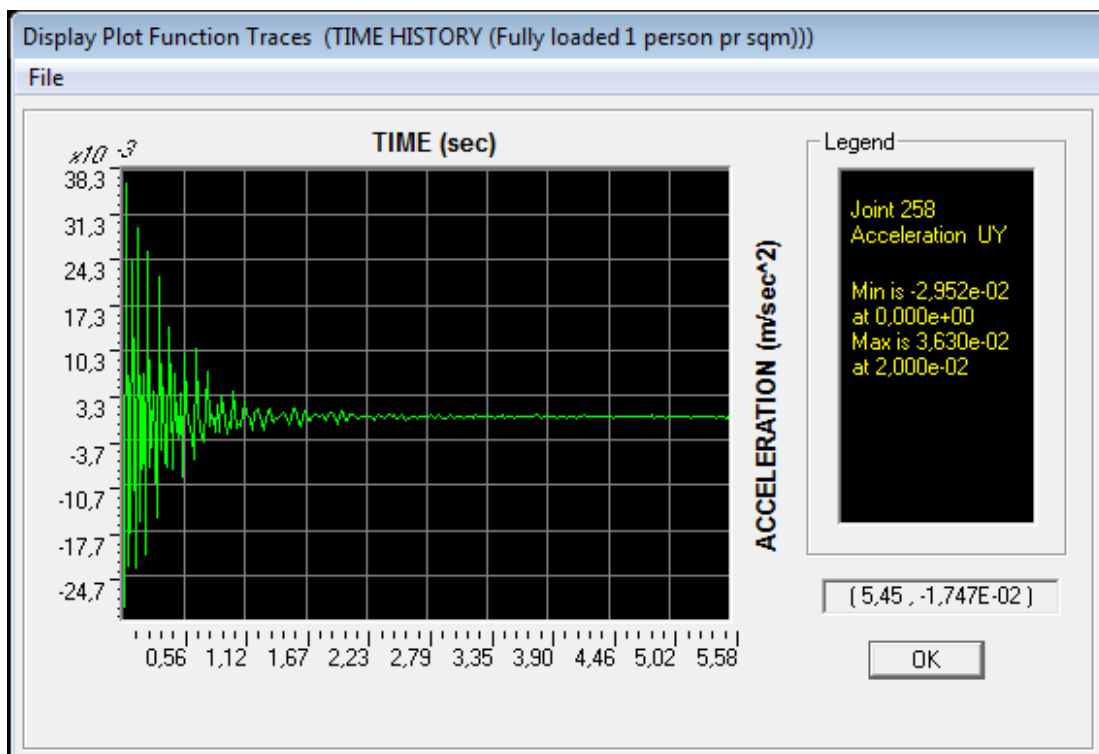

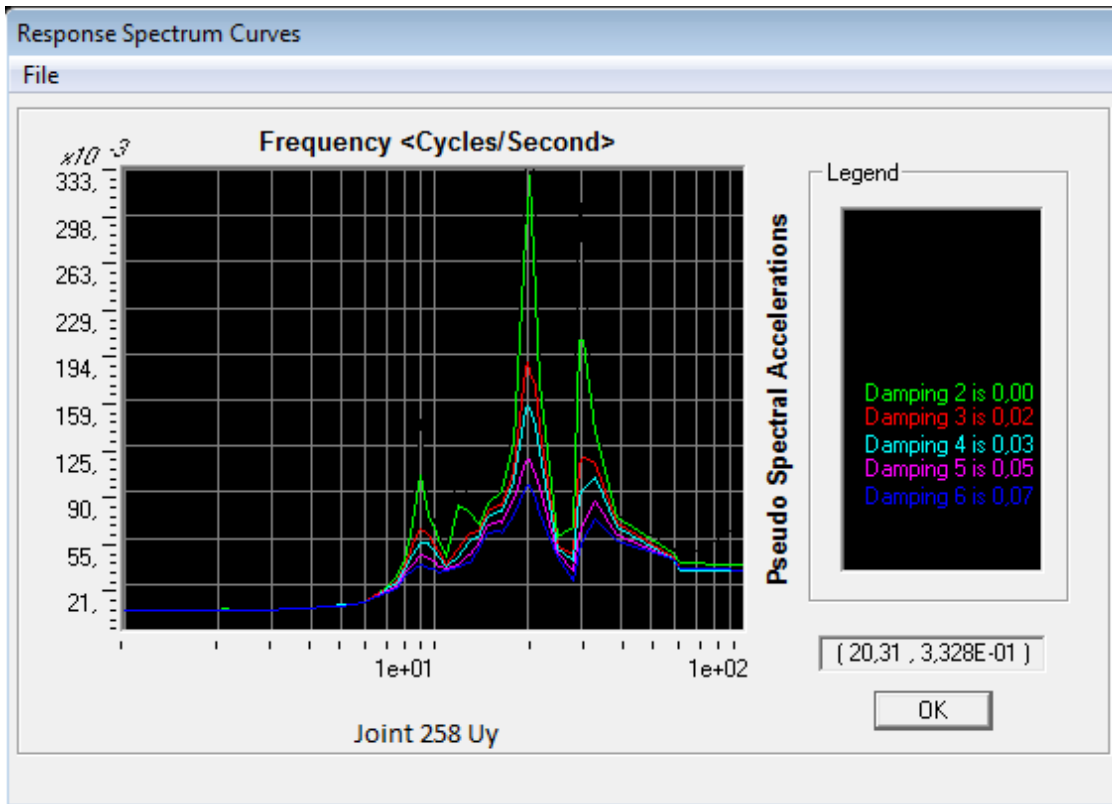

Max. acceleration in Z (vertical)		Min. acceleration in Z (vertical)	
Joint	(m/s ²)	Joint	(m/s ²)
191	0,67470002	207	-0,88865273
207	0,67424523	191	-0,88753997
199	0,6511739	196	-0,86288825
200	0,58952402	197	-0,73641395
252	0,53015516	199	-0,72115762
218	0,53015477	200	-0,66862771
198	0,50942281	201	-0,65449917
219	0,5073109	198	-0,62783053
253	0,50730999	195	-0,62032061
23	0,50613502	211	-0,60902668

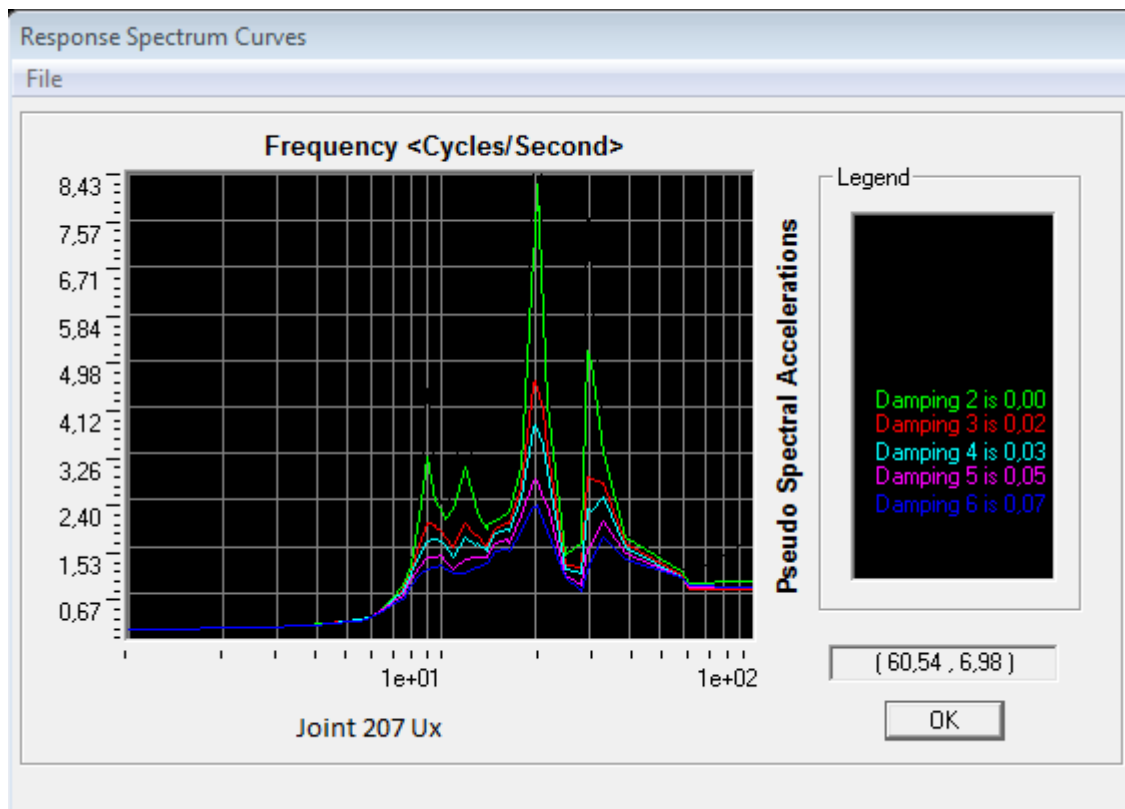
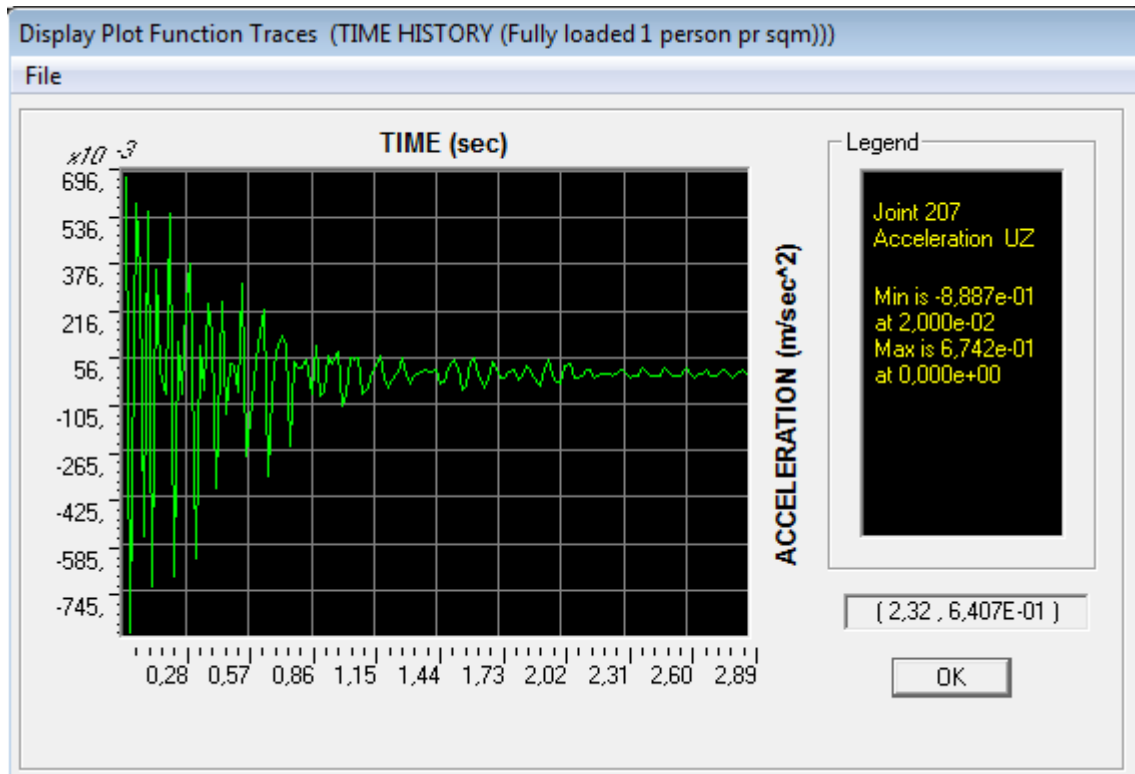

7. Results

7.1. Collected results from FEM (SAP 2000): Method 2 & Method 3

Method 3: 2 persons in direct integration			
Joint	Horizontal acceleration (m/sec ²)	Joint	Vertical acceleration (m/sec ²)
39	0,00244544	196	-0,39560349
Method 3: 2 persons in modal (Ritz vector)			
258	-0,16922112	45	-0,91202917
Method 3: 4 persons in direct integration			
7	0,0037768	196	-0,33976603
Method 3: 4 persons in modal (Ritz vector)			
13	-0,27487392	192	-1,10494811
Method 3: 0,5 persons/m² in direct integration			
7	0,00163807	195	-0,150387435
Method 3: 0,5 persons/m² in modal (Ritz vector)			
55	0,21486031	5	-0,37840861
Method 3: 1 persons/m² in direct integration			
43	-0,0023934	195	-0,47077732
Method 3: 1 persons/m² in modal (Ritz vector)			
258	0,03629975	207	-0,88865273
Method 2: 0,5 persons/m² direct integration			
17	-0,000039812	51	0,017502161
Method 2: 0,5 persons/m² modal (Ritz vector)			
13	0,00074222	199	-0,02117706
Method 2: 1 persons/m² direct integration			
19	-0,00044089	199	-0,14223252
Method 2: 1 persons/m² modal (Ritz vector)			
242	0,01040409	191	-0,26776178

7.2. Comparing results with the guideline [2]

Type of pedestrian loading		Method 1 SDOF			Method 2 Dynamic A_{max} (m/sec ²)		Method 3 [2] Time History A_{max} (m/sec ²)		Comfort Class	Acceleration limits (m/sec ²)
		A_{max} ,95% (m/sec ²)	ψ	A_{max} ,d (m/sec ²)	Modal analysis	Direct integrat	Modal analyse	Direct integrati		
2 persons	Vertical	4,5855E-4	0	0	-	-	- 0,91202	- 0,3956	CL 2 (Medium)	0,50 – 1,00 m/s ²
	Horizontal	1,62E-04*	0	0	-	-	- 0,16922	0,00244	CL 2 (Medium)	0,10 – 0,30 m/s ²
4 persons	Vertical	6,47E-04	0	0	-	-	- 1,10494	- 0,3397	CL 3 (Min) very close to CL 2 (Medium)	1,00 – 2,50 m/s ²
	Horizontal	2,28E-04*	0	0	-	-	- 0,27487	0,00377	CL 2 (medium)	0,10 – 0,30 m/s ²
0,5 person/m ²	Vertical	2,47E-03	0	0	- 0,021	0,01750	- 0,37840	- 0,1503	CL 1 (Maximum)	<0,50 m/s ²
	Horizontal	8,58E-04*	0	0	7,4E-4	-4E-5	0,21486	0,00163	CL 2 (Medium)	0,10 – 0,30 m/s ²
1 person/m ²	Vertical	2,68E-03	0	0	- 0,267	- 0,1422	- 0,88865	- 0,4707	CL 2 (Medium)	0,50 – 1,00 m/s ²
	Horizontal	1,10E-03	0	0	0,01	-4,4E-4	0,03629	- 0,0023	CL 1 (Maximum)	< 0,10 m/s ²

* = These results came from the absolute value acceleration variance

Table: Defined comfort classes with common acceleration ranges 7.2.1 [2]

Comfort class	Degree of comfort	Vertical a_{limit}	Lateral a_{limit}
CL 1	Maximum	$< 0,50 \text{ m/s}^2$	$< 0,10 \text{ m/s}^2$
CL 2	Medium	$0,50 - 1,00 \text{ m/s}^2$	$0,10 - 0,30 \text{ m/s}^2$
CL 3	Minimum	$1,00 - 2,50 \text{ m/s}^2$	$0,30 - 0,80 \text{ m/s}^2$
CL 4	Unacceptable discomfort	$> 2,50 \text{ m/s}^2$	$> 0,80 \text{ m/s}^2$

Results show all accelerations are under control.

8. Discussion

The findings and results show some hindering and shortcomings. There are some limits in analytical calculations i.e. the guidelines satisfy when the frequencies are out of resonance range, which means no calculations needed since the reduction factor (ψ) = 0.

Luckily or unluckily the bridge in this thesis is not in resonance range therefore guidelines formulas are not in position to deal with this situation. One guideline: Setra [1] gives this acceleration formula:

$$\text{Acceleration}_{\max} = \frac{1}{2\xi_n} \frac{4F}{\pi\rho S}$$

Where:

F = load

Fs = load /unit area: as a cosine functions depending Case 1: disperse crowd or Case 2: very dense crowd as defined previous chapters.

lp = usable width

F = Fs*lp

If the frequency is out of the range, this formula gives very high acceleration.

The other guideline JRC [2] gives following acceleration formula:

$$a_{\max,95\%} = k_{a,95\%} * \sqrt{\sigma_a^2} \quad [2]$$

Where :

$a_{\max,95\%}$ = acceleration (95th percentile)

$k_{a,95\%}$ = constant

$(\sigma a)^2$ = acceleration variance which takes minus sign in case the frequency is out of range

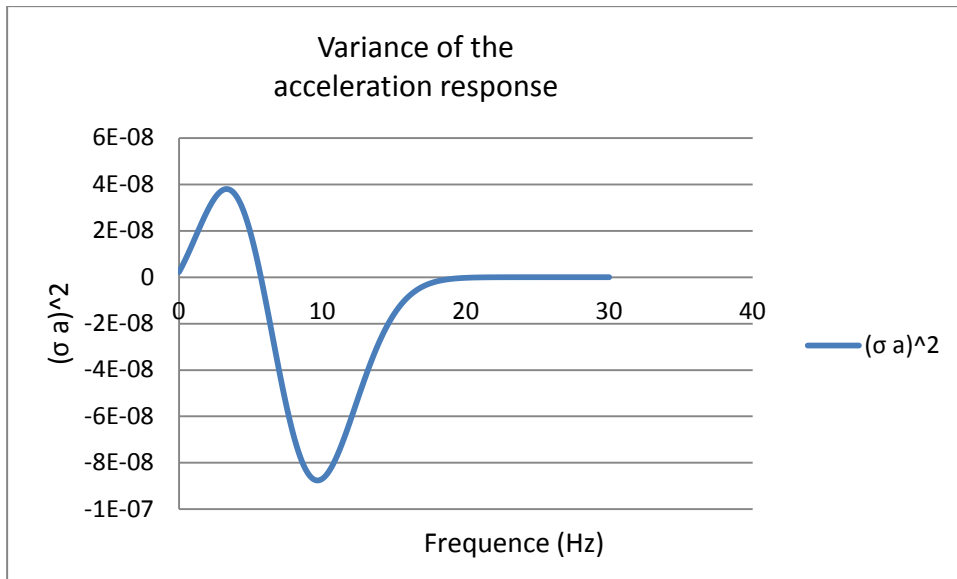

Graph: in this case lateral frequency over 5,7 Hz gives negative variance $(\sigma a)^2$ of the acceleration response.

This footbridge vibration accelerations are satisfied in both analytical and FEM i.e. analytically in frequency range before acceleration calculation also some analytical accelerations without reduction factor (ψ) showed good results, under acceleration limit. In FEM accelerations results satisfied.

In my opinion it is better to analyses a footbridge which coincide resonance frequency range in order to reach final results in both analytical and FEM.

9. Conclusion

This thesis was performed using FEM (Finite Element method) programme: SAP2000 and analytical calculations based on guidelines, mainly from Setra [1] and JRC [2].

Results from guidelines formulas were compared against FEM with conventional dynamic method load analysis and FEM with unconventional Time History loads created in this process which showed promising results. Different pedestrian densities were used in the analysis. All methods were analysed in both modal and direct integration

Frequencies calculations analytically and SAP2000 showed that they have almost same results in the first mode only, the analytical modes rise steeply as the mode number increases instead of SAP2000 frequencies rise gently. In analytical calculation, mass of the structure and pedestrians loads are added while FEM separate as mass and load.

Footbridge guidelines do not deal with vertical and horizontal frequencies beyond resonance range i.e. vibration criteria is satisfied and further calculations are unnecessary. Guidelines have no limits for torsional and longitudinal accelerations at all.

The analytical calculations are based on simple beam theories and sometimes unsuitable for complicated bridge sections of different geometry and material i.e. more studies are needed of different types of footbridges.

More accurate calculation of 2nd areal moment (I) both in vertical and horizontal are very important, especially for complicated bridge cross-sections is vital to get more accurate results.

Guidelines [1], [2] have different formulas for accelerations and slightly different range of resonance frequencies, but they are common in satisfying when the frequencies are out of the resonance range.

10. References

- [1] Sétra, Assessment of vibrational behaviour of footbridges under pedestrian loading Published by the Sétra, realized within a Sétra/Afgc (French association of civil engineering) working group
- [2] Design of Lightweight Footbridges for Human Induced Vibrations (JCR, Christoph Heinemeyer, Christiane Butz, Andreas Keil, Mike Schlaich, Arndt Goldack, Stefan Trometer, Mladen Lukić, Bruno Chabrolin, Arnaud Lemaire, Pierre-Olivier Martin, Álvaro Cunha, Elsa Caetano)
- [3] Modelling Spatially Unrestricted Pedestrian Traffic on Footbridges
Stana Živanović*, Aleksandar Pavić†, Einar Thór Ingólfsson‡
- [4] Norsk Standard NS-EN 1990:2002/A1:2005+NA:2010

11. Appendices

11.1. *Appendix 1.*

Selfweighth modes

SAP2000

3.18.13 16:18:26

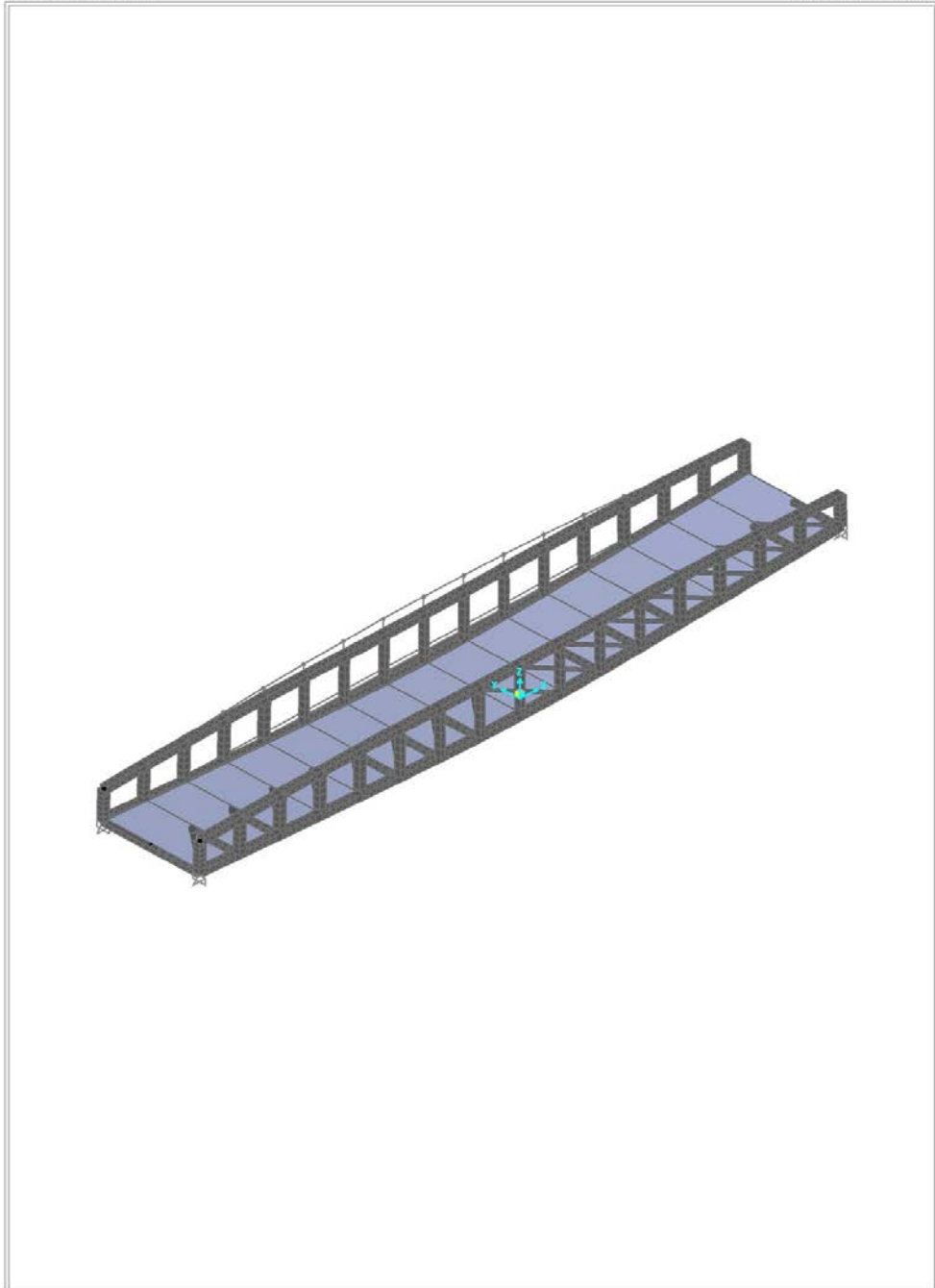

SAP2000 v15.1.0 - File:Selfweight Modes2 - Deformed Shape (MODAL) - Mode 1 - T = 0,34641; f = 2,88673 - KN, m, C Unit

Vertical mode 1

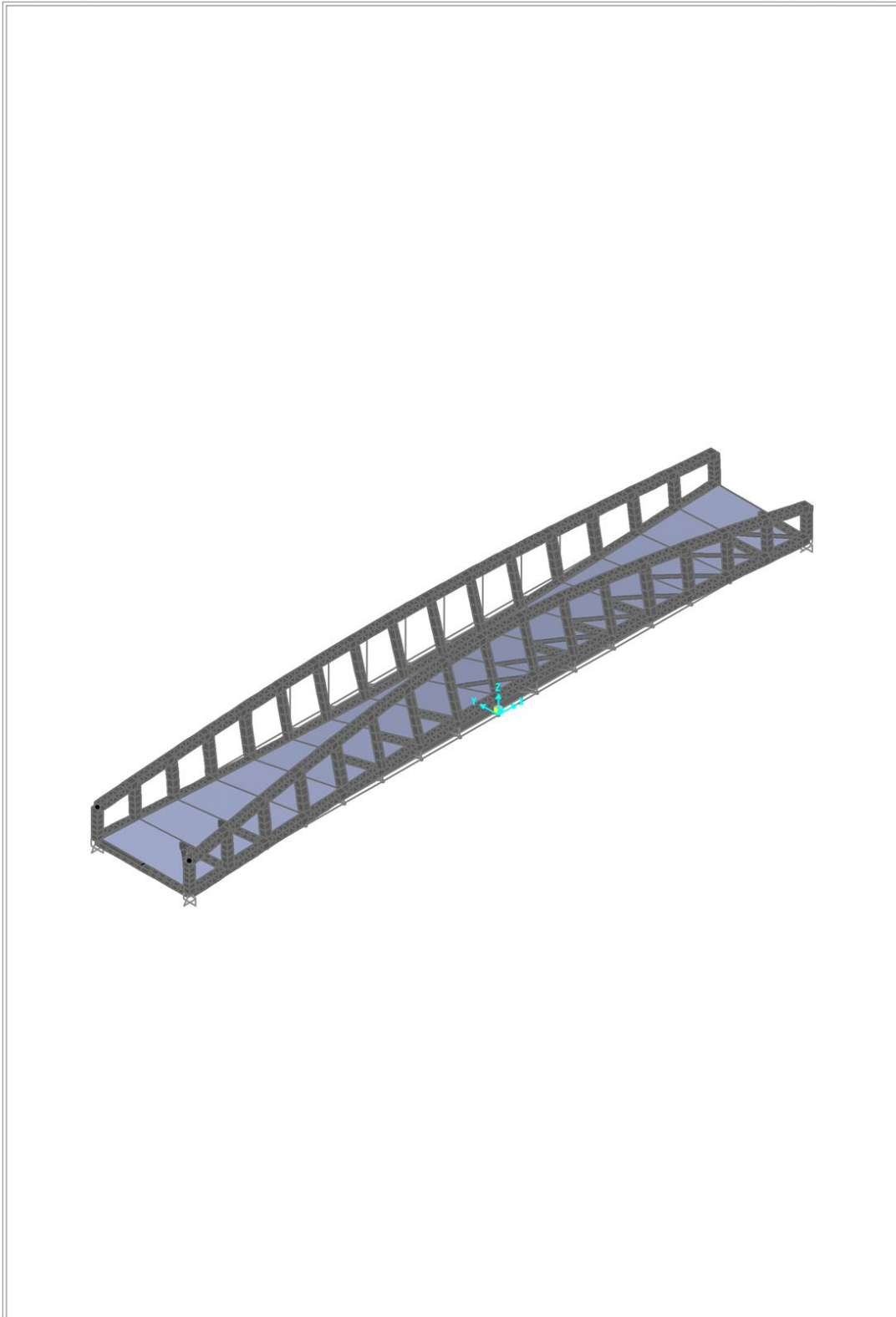

SAP2000 v15.1.0 - File:Selfweight Modes2 - Deformed Shape (MODAL) - Mode 2 - T = 0,28014; f = 3,56964 - KN, m, C Unit

Torsional mode 1

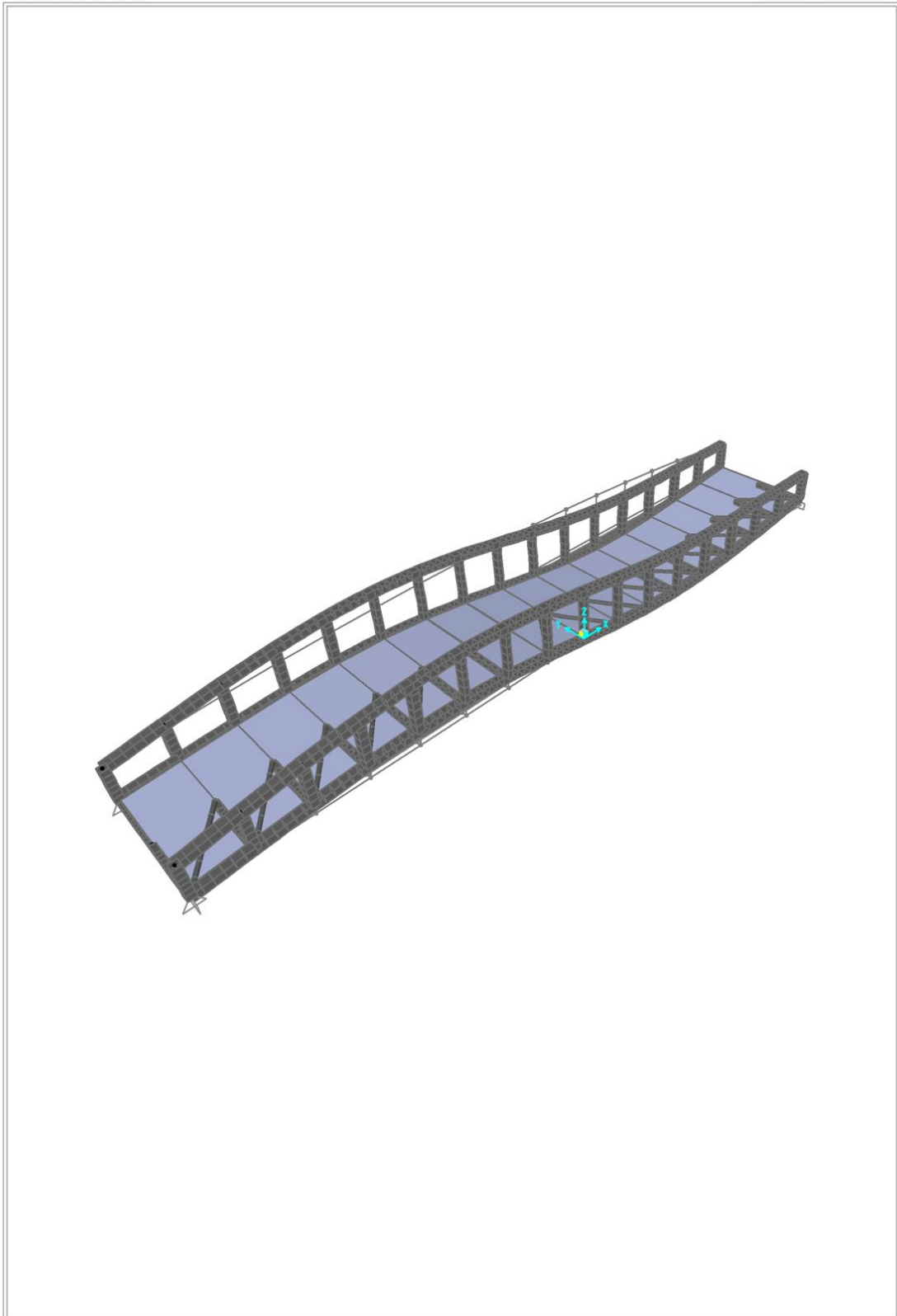

SAP2000 v15.1.0 - File:Selfweight Modes2 - Deformed Shape (MODAL) - Mode 3 - T = 0,19184; f = 5,21264 - KN, m, C Unit

Vertical mode 2

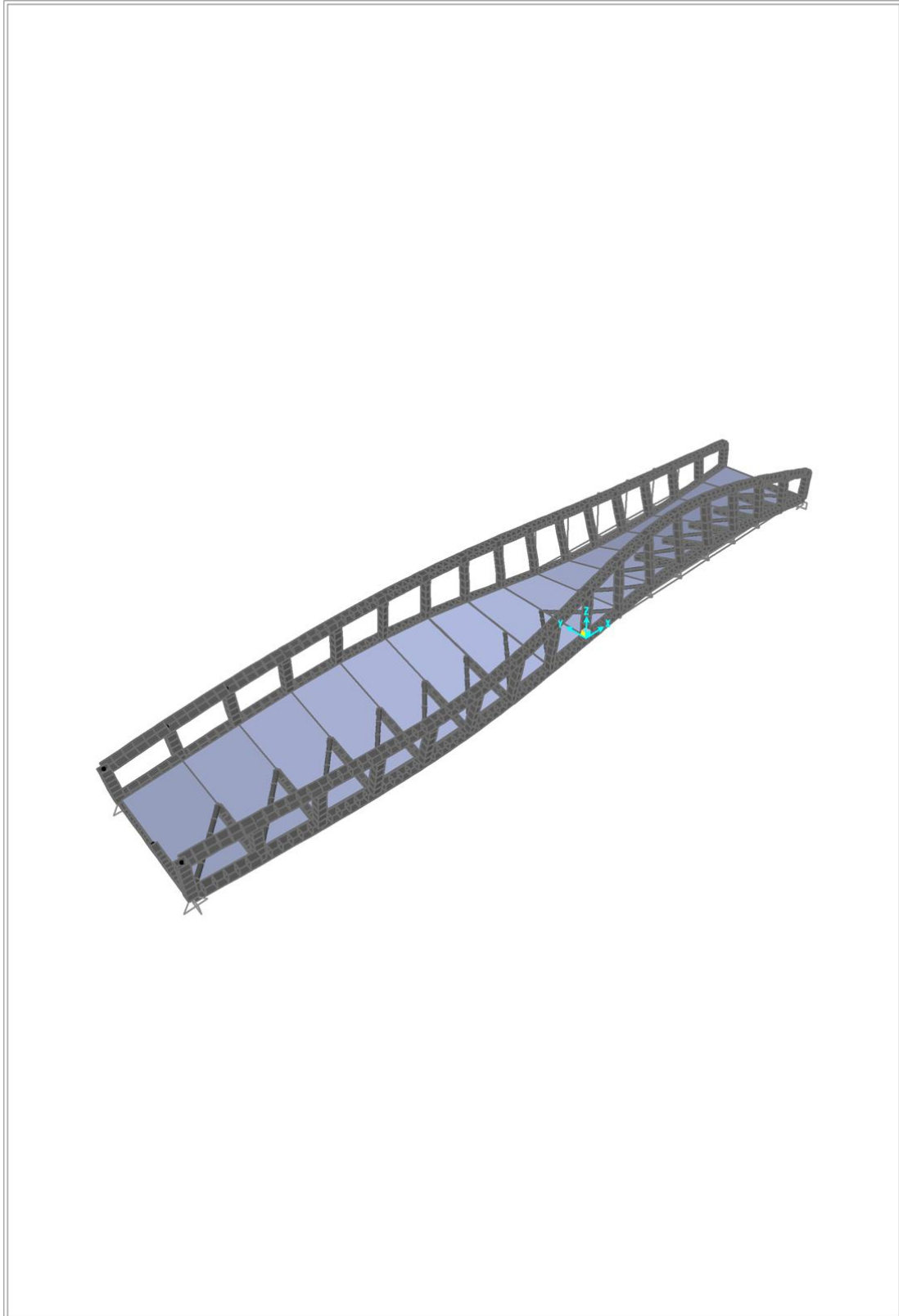

SAP2000 v15.1.0 - File:Selfweight Modes2 - Deformed Shape (MODAL) - Mode 4 - T = 0,15232; f = 6,56507 - KN, m, C Unit

Torsional mode 2

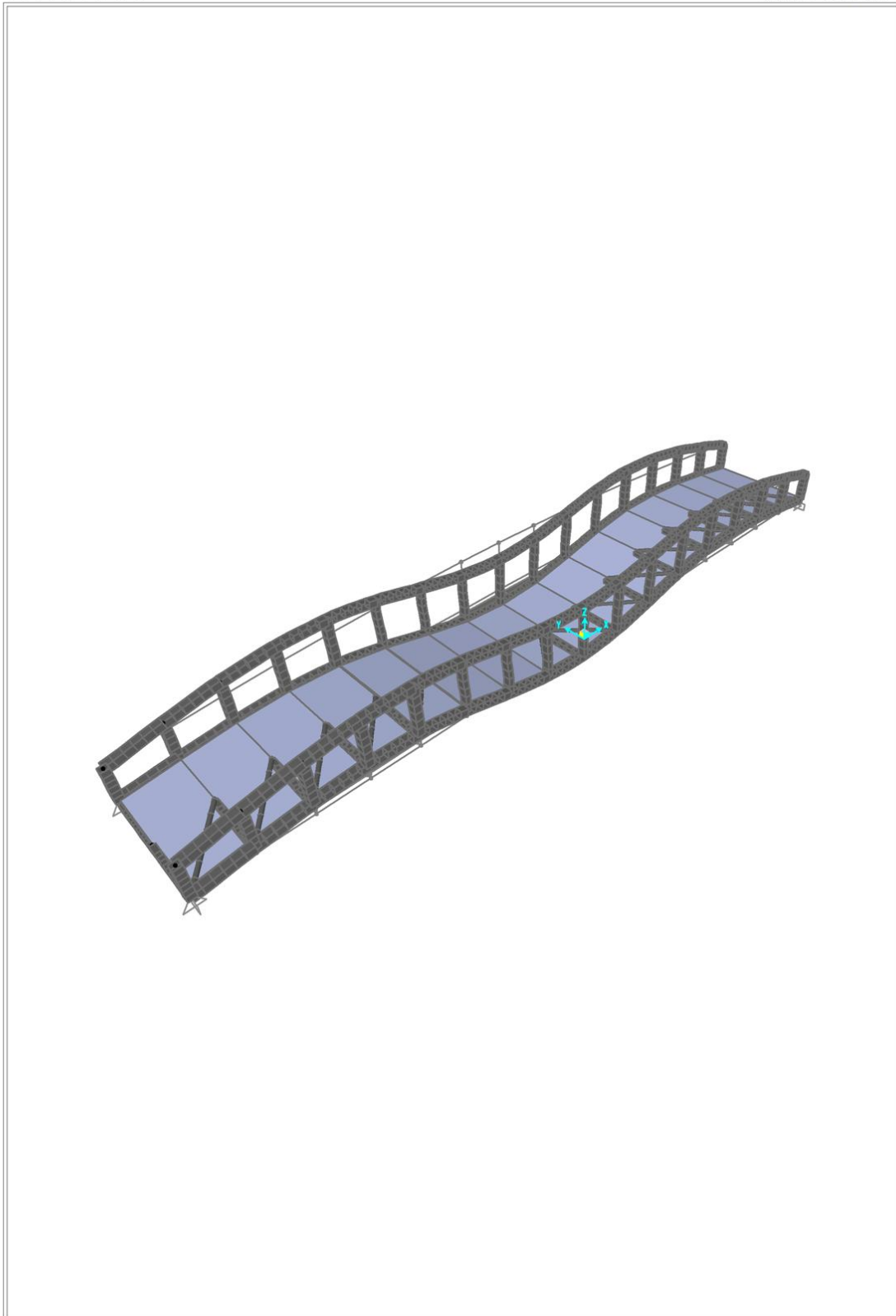

SAP2000 v15.1.0 - File:Selfweight Modes2 - Deformed Shape (MODAL) - Mode 5 - T = 0,11591; f = 8,62735 - KN, m, C Unit

Vertical mode 3

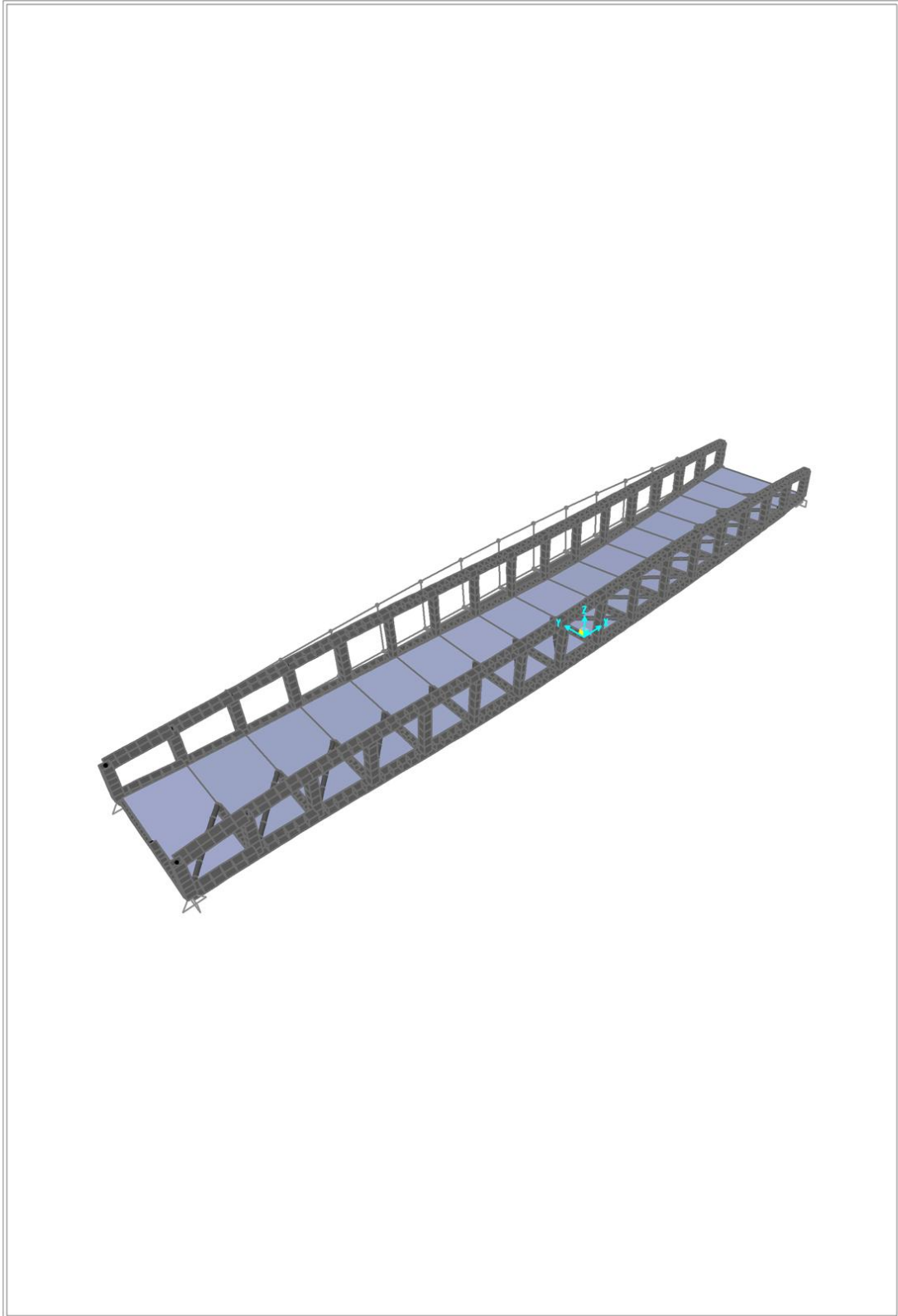

SAP2000 v15.1.0 - File:Selfweight Modes2 - Deformed Shape (MODAL) - Mode 6 - T = 0,10268; f = 9,73931 - KN, m, C Unit

Horizontal/transverse mode 1

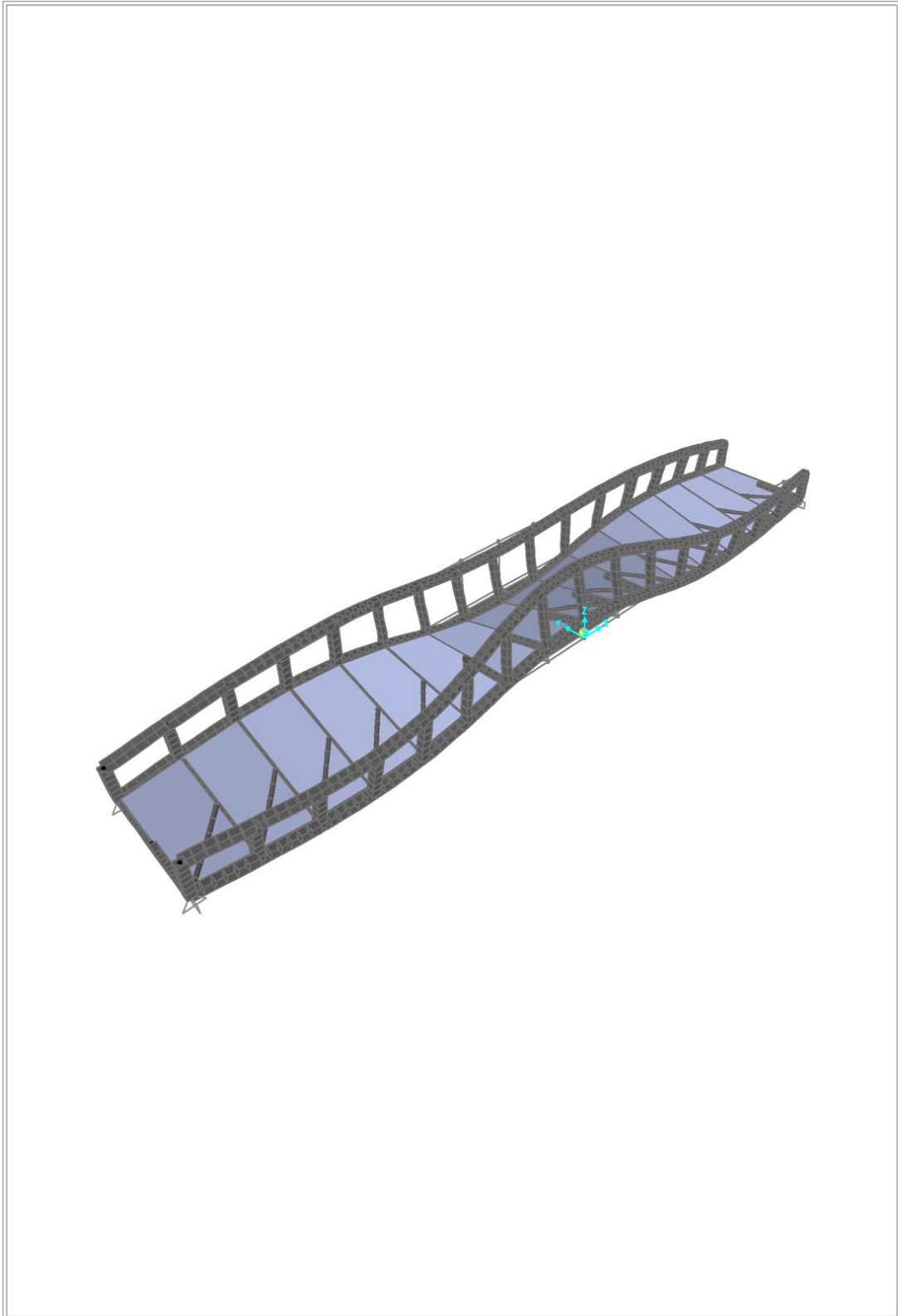

SAP2000 v15.1.0 - File:Selfweight Modes2 - Deformed Shape (MODAL) - Mode 7 - T = 0,09431; f = 10,60315 - KN, m, C Un

Torsional mode 3

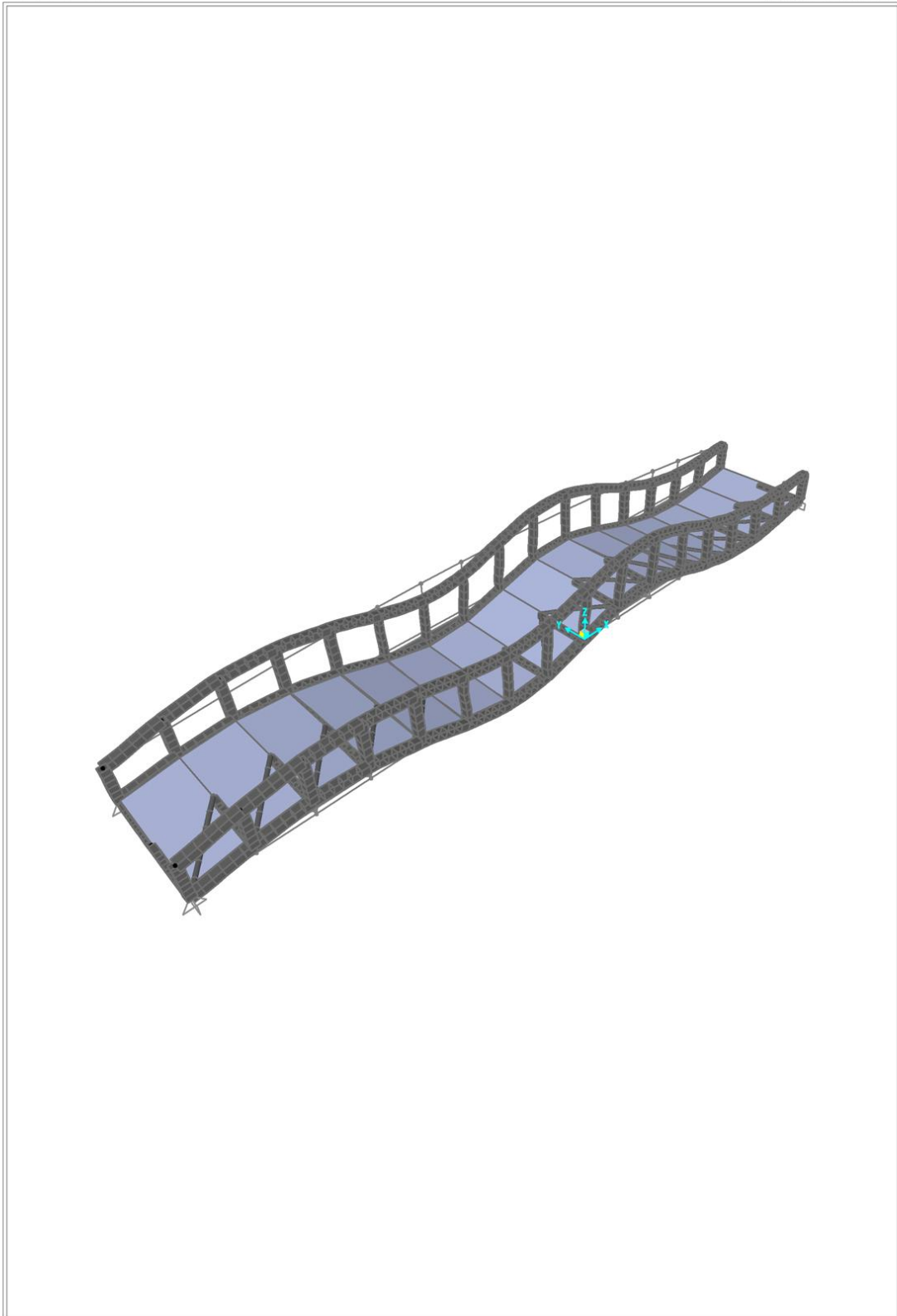

SAP2000 v15.1.0 - File:Selfweight Modes2 - Deformed Shape (MODAL) - Mode 8 - T = 0,07706; f = 12,97695 - KN, m, C Un

Vertical mode 4

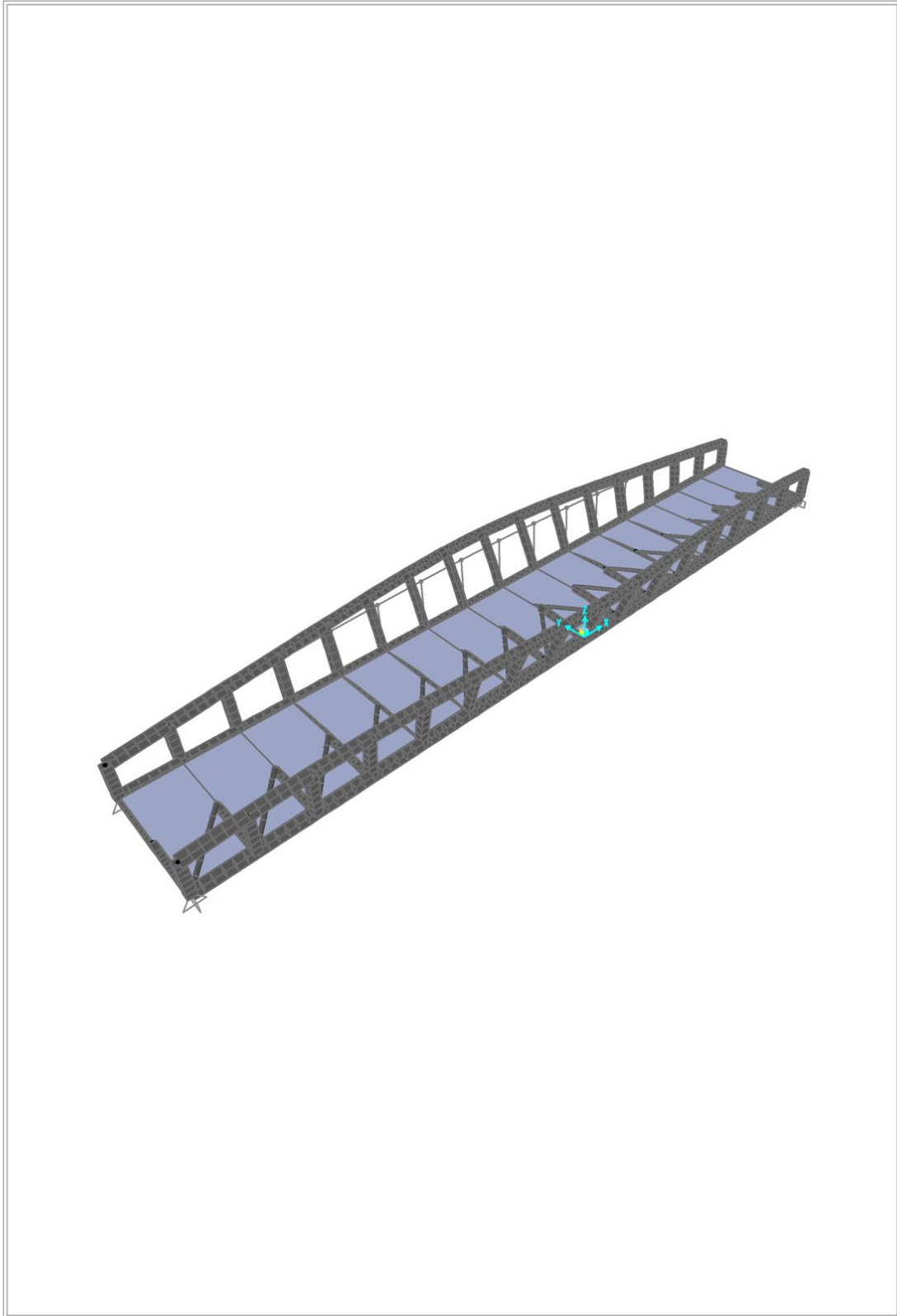

SAP2000 v15.1.0 - File:Selfweight Modes2 - Deformed Shape (MODAL) - Mode 9 - T = 0,07050; f = 14,18466 - KN, m, C Un

Horizontal mode 1 (upper chords in opposite directions)

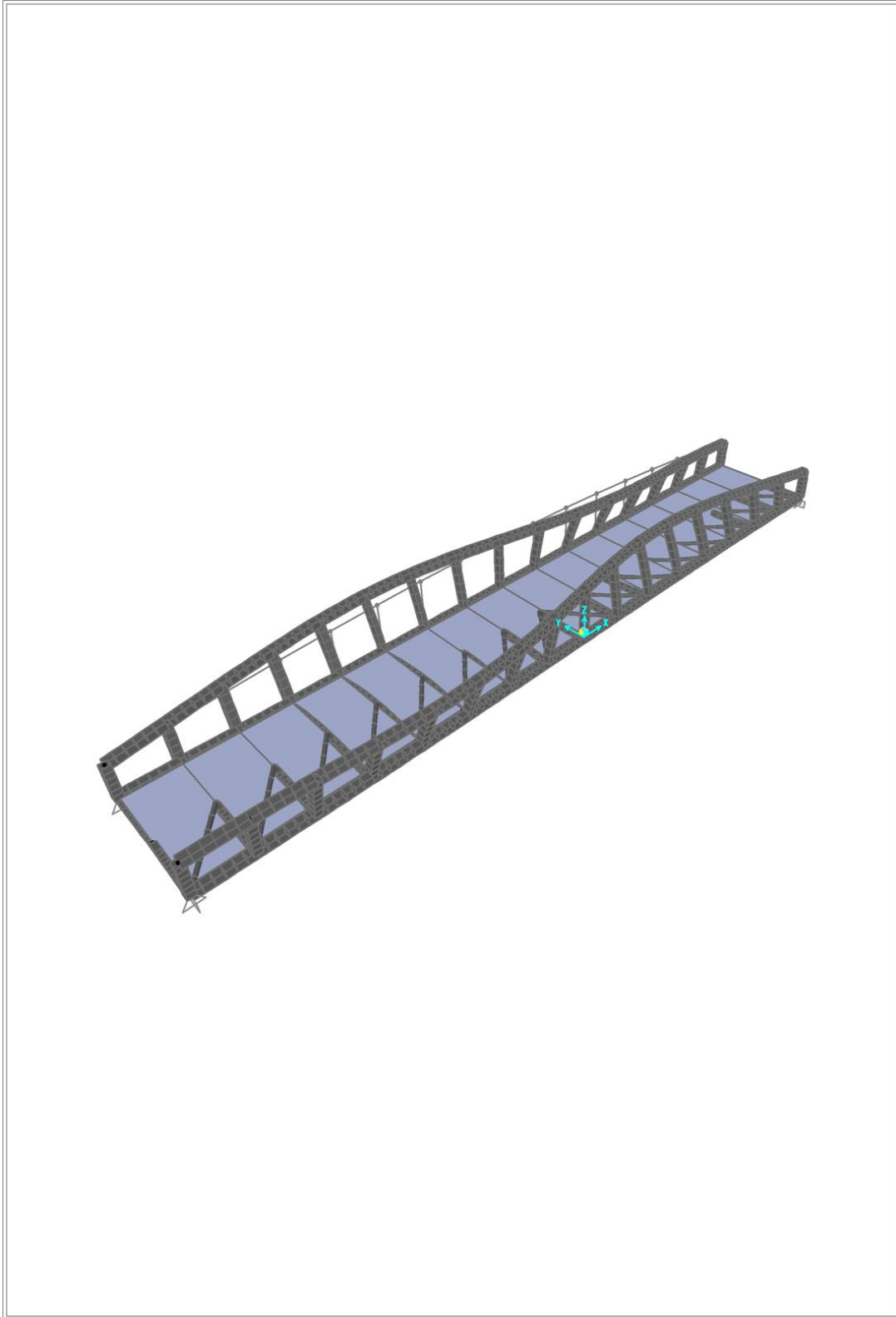

SAP2000 v15.1.0 - File:Selfweight Modes2 - Deformed Shape (MODAL) - Mode 10 - T = 0,05875; f = 17,02174 - KN, m, C U

Horizontal mode 2

(Upper chords in opposite direction)

SAP2000

3.18.13 17:27:10

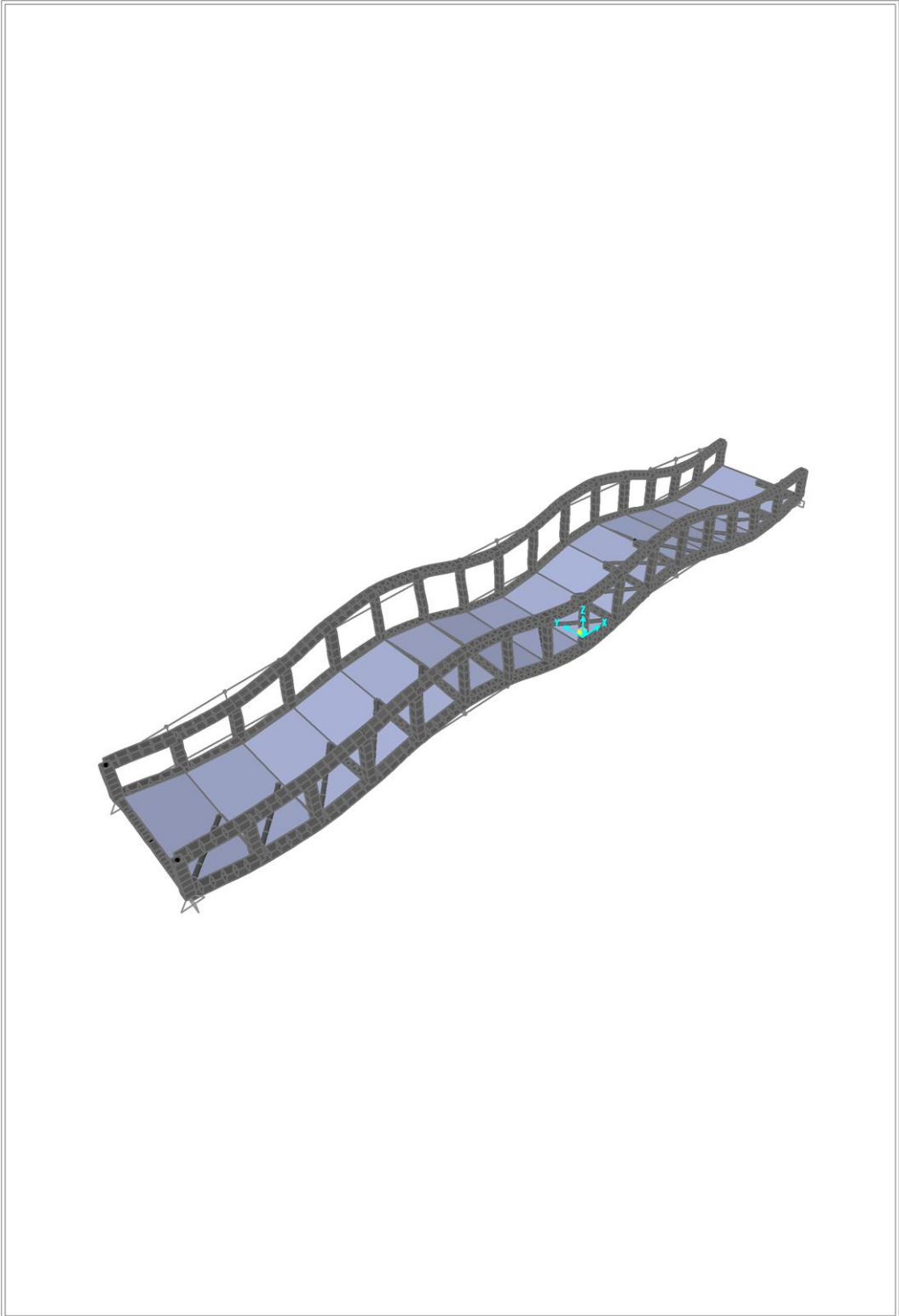

SAP2000 v15.1.0 - File:Selfweight Modes2 - Deformed Shape (MODAL) - Mode 11 - T = 0,05755; f = 17,37703 - KN, m, C U

Vertical mode 5

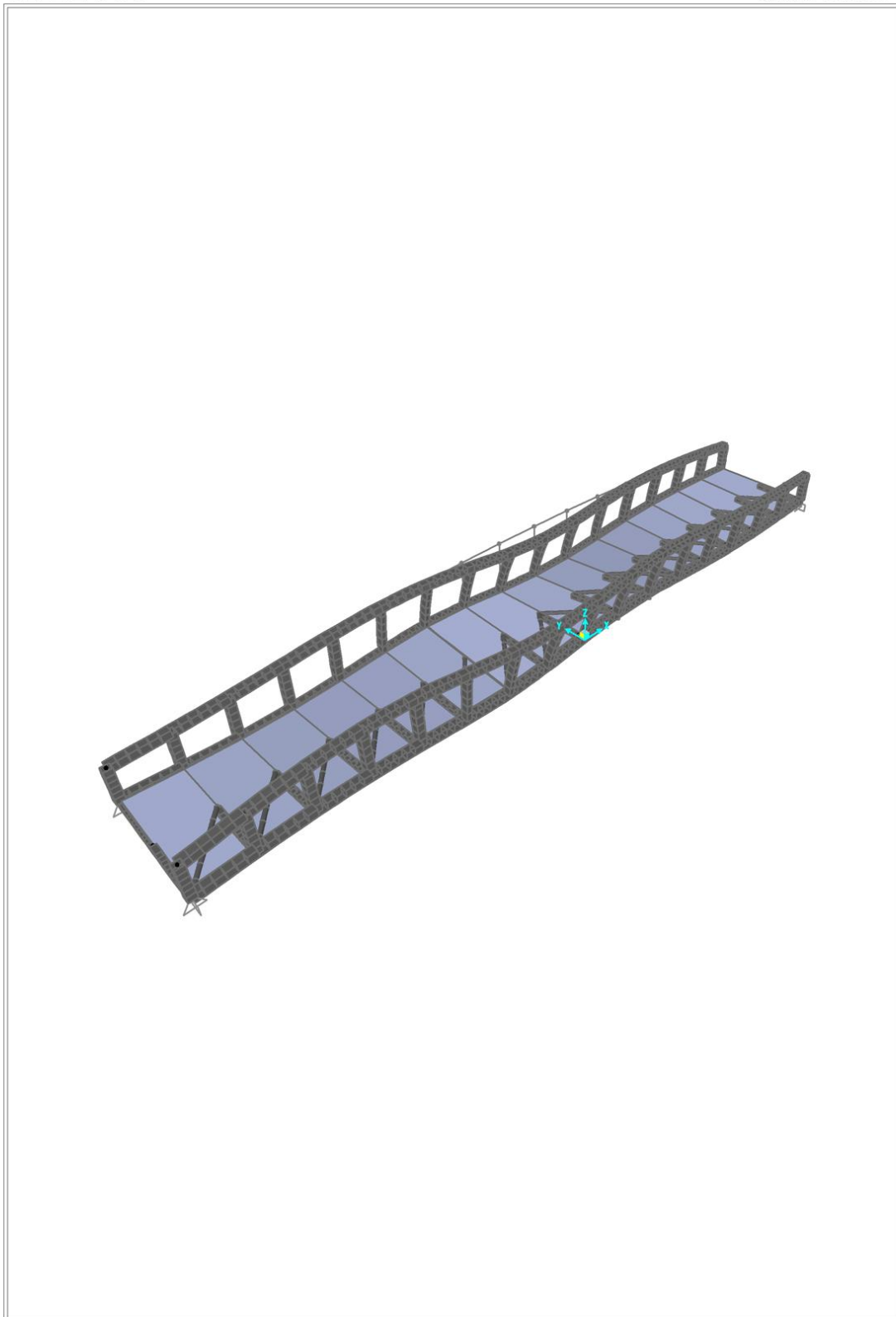

SAP2000 v15.1.0 - File:Selfweight Modes2 - Deformed Shape (MODAL) - Mode 12 - T = 0,05715; f = 17,49660 - KN, m, C U

Torsional mode 4

SAP2000

3.18.13 17:42:59

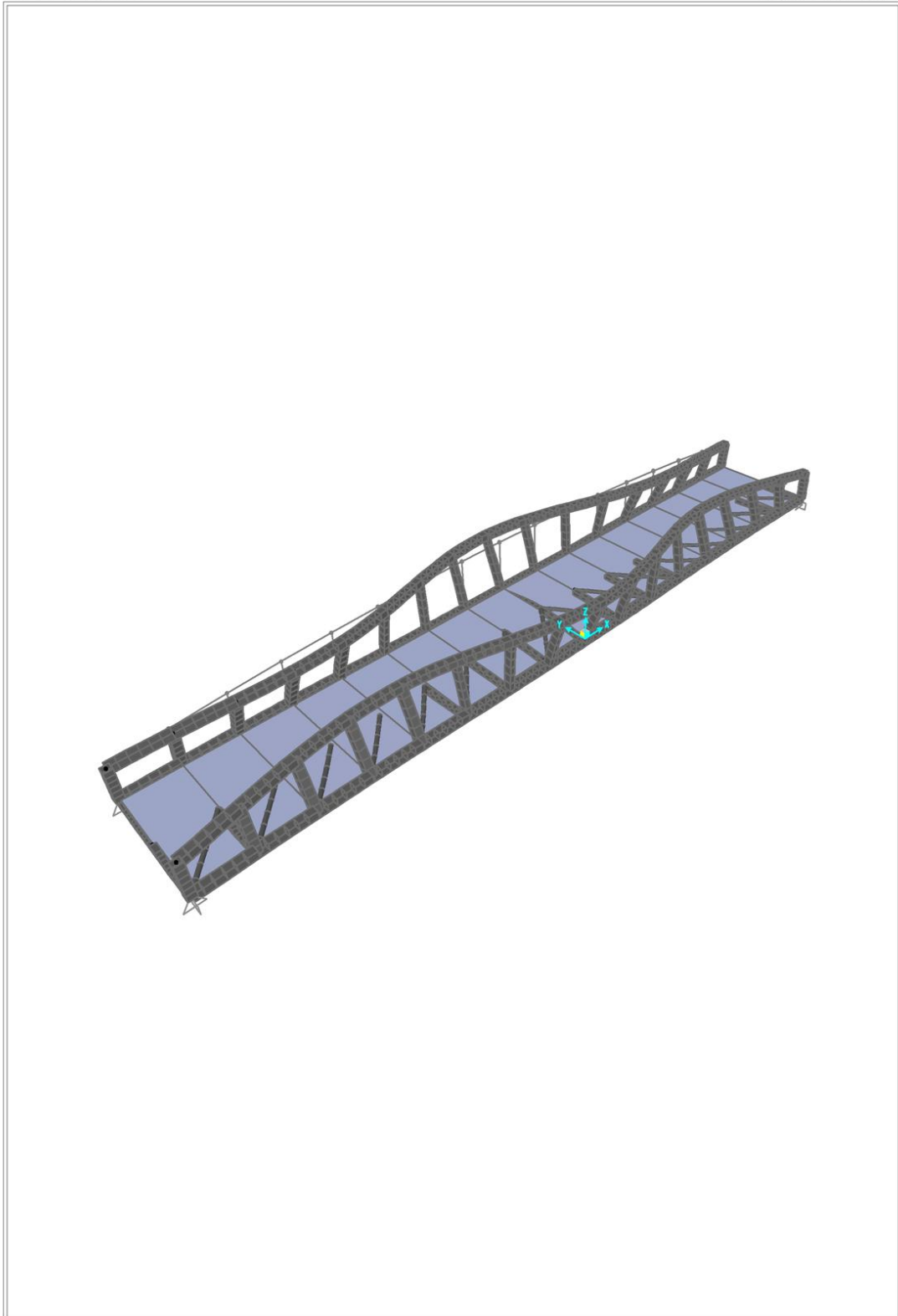

SAP2000 v15.1.0 - File:Selfweight Modes2 - Deformed Shape (MODAL) - Mode 13 - T = 0,04890; f = 20,44932 - KN, m, C U

Horisontal mode 3

(Upper chord in opposite directions)

SAP2000

3.18.13 17:47:46

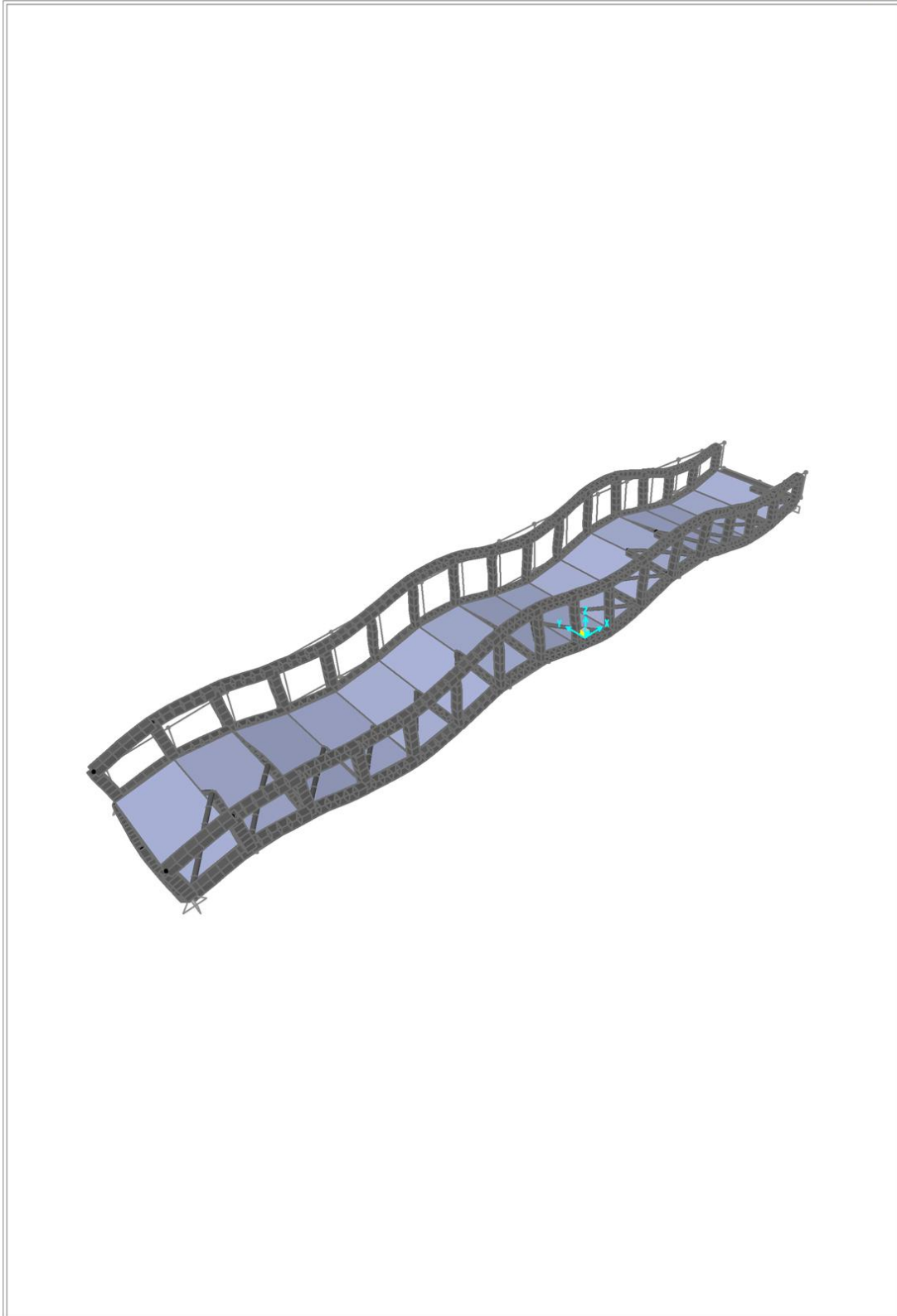

SAP2000 v15.1.0 - File:Selfweight Modes2 - Deformed Shape (MODAL) - Mode 14 - T = 0,04796; f = 20,84973 - KN, m, C U

Vertical mode 6

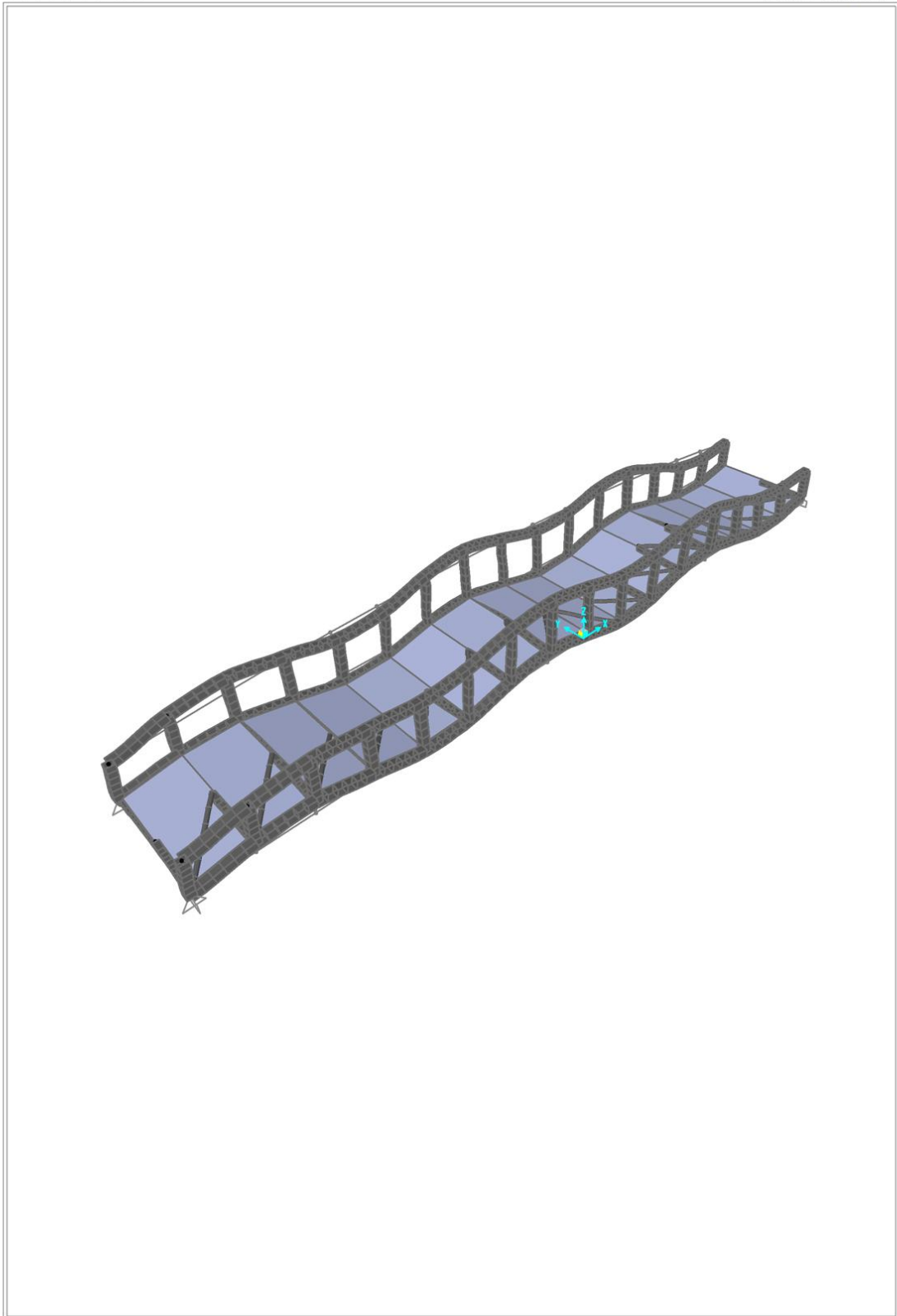

SAP2000 v15.1.0 - File:Selfweight Modes2 - Deformed Shape (MODAL) - Mode 15 - T = 0,04568; f = 21,88999 - KN, m, C U

Vertical mode 6

11.2. Appendix 2.

Histograms of maxima of z_i (eq. 4-14) are firstly obtained on the basis of 2500 simulations for each set of parameters, every simulation consisting of taking n random values of both the standardized normal variable u_j and the phase shift ψ_j . A maximum of z_i is taken on a 2-period range (simulations carried out have shown that an 8-period range gives the same results). Coefficient k_{eq} is then calculated (eq. 4-13) on the basis of values of z_i obtained as explained above. Figure 4-9 gives an example of histogram of k_{eq} . Finally, 95th percentile of k_{eq} is determined.

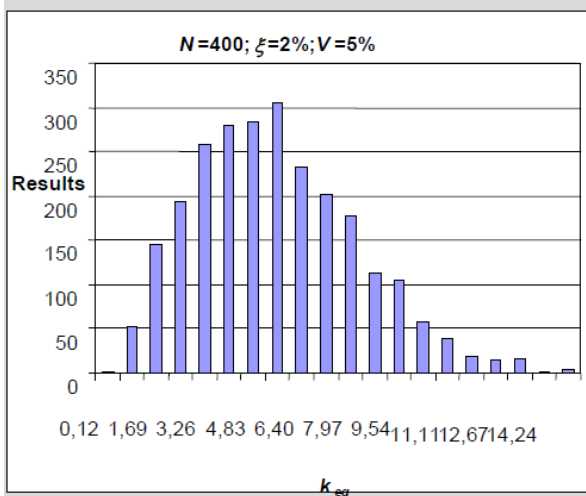

Figure 4-9: An example of resulting histogram

With such a value of k_{eq} , the equivalent number of pedestrians, n' can be obtained. Expressions for this equivalent number have been derived by regression as a function of the damping ratio and the total number of pedestrians on the footbridge.

4.5.1.2 Application of load models

In the recommended design procedure, harmonic load models are provided for each traffic class TC1 to TC5 (cf. Table 4-3). There are two different load models to calculate the response of the footbridge due to pedestrian streams depending on their density:

- Load model for TC1 to TC3 (density $d < 1,0$ P/m²)
- Load model for TC4 and TC5 (density $d \geq 1,0$ P/m²)

Both load models share a uniformly distributed harmonic load $p(t)$ [N/m²] that represents the equivalent pedestrian stream for further calculations:

$$p(t) = P \times \cos(2\pi f_s t) \times n' \times \psi$$

Eq. 4-15

where

$$P \times \cos(2\pi f_s t)$$

is the harmonic load due to a single pedestrian,

P is the component of the force due to a single pedestrian with a walking step frequency f_s ,

f is the step frequency, which is assumed equal to the footbridge natural frequency under consideration,

n' is the equivalent number of pedestrians on the loaded surface S ,

S is the area of the loaded surface,

ψ is the reduction coefficient taking into account the probability that the footfall frequency approaches the critical range of natural frequencies under consideration.

12. Attachments

CD: contains:

- SAP20000 Files
- Exel Files
- Thesis Text