



University of  
Stavanger

## Faculty of Science and Technology

# MASTER'S THESIS

Study program/ Specialization:  
Petroleum Engineering/  
Reservoir Engineering

Spring semester, 2011

Open

Writer: John Emeka Udegbonam

.....  
(Writer's signature)

Faculty supervisor(s): Professor Tor Austad  
Dr Skule Strand

Title of thesis:

**EOR in Chalk: Optimized Oil Recovery with Modified Seawater.**

Credits (ECTS): 30

Key words:

Chalk

Wettability alteration

Modified seawater

Enhanced oil recovery

Pages: 60

+ enclosure: 5

Stavanger, 15<sup>th</sup> June, 2011.

Date/year

## **Acknowledgements**

I want to use this opportunity to express a heartfelt gratitude to my supervisor, Professor Tor Austad, for offering me a thesis topic that I find very interesting. His wealth of experience and passion for his work is a great source of inspiration to me. Prof. Tor is an enthusiastic person and his door is always open. I consider myself very fortunate to be part of his outstanding research team.

I also wish to acknowledge the contribution made by Post Doc. Skule Strand, towards the success of this work. I thank him for his thorough guidance, inspiring discussions, and proof reading of my thesis. I appreciate his analytical skills and the ability to point out improvement areas.

I would like to thank the PhD student, Jafar Fathi for his encouragement and immense assistance in the laboratory tests. He devoted his time to ensure that I made progress, in spite of the tight schedule that he had during the period.

I would like to thank Hakan Aksulu for his assistance, especially at the later part of my work.

I also wish to acknowledge the University of Stavanger and the Department of Petroleum Engineering for offering me a good working environment.

I need to say a big thanks to my adorable and devoted wife, Obianuju Udegbuam, for all her unflinching supports. With her by my side, there is neither a journey that is too far nor a night that is too dark.

No word can express my warm feelings of thanksgiving to my Divine Creator for making it possible for me to actualize my dream. His love and grace keep me going, even in the face of wayward circumstances.

John Emeka Udegbunam

## Abstract

The effect of using seawater or modified seawater as a wettability modifier in chalk has been previously investigated at higher temperatures. This work has shown that “smart water” improves the oil recovery due to wettability alteration at temperatures above 90°C.

In this work, the effect of modifying the salinity and the ionic composition of seawater on oil recovery from chalk is studied at lower temperatures, 90 and 70°C. respectively.

The chalk cores with 10 % initial water saturation were saturated, flooded and aged with the synthetic crude oil (with AN= 0.5mgKOH/g oil). Then, the cores were imbibed with different imbibing fluids. The brine VBOS, with no ability to change the wetting condition of the core was used as the reference brine. Seawater was modified by reducing the concentrations of the non-active ions,  $\text{Na}^+$  and  $\text{Cl}^-$ . Also, the concentration of sulfate which has a catalytic effect on the wettability alteration was increased. The chromatographic wettability test was used to determine the water-wet surface area of the chalk cores after the spontaneous imbibition tests. The experimental work showed improved oil recovery when modified seawater was used both at 90 and 70°C. The surface active ions ( $\text{SO}_4^{2-}$  and  $\text{Ca}^{2+}$ ) had easier access to the chalk surface by reducing the concentrations of the non-active ions in seawater. Increasing the sulfate concentration, improved both imbibition rate and ultimate recovery. For a slightly water-wet system, “smart water” was able to improve the oil recovery at temperatures down to 70°C.

The wettability alteration process was confirmed by the chromatographic wettability tests. The tests indicated that the water-wet surface area in the cores increased with increasing “smartness” of seawater.

## Abbreviations and symbols

<i>A</i>	Adsorption area
<i>AN</i>	Acid number, mg KOH/g oil
<i>ASTM</i>	American Society for Testing and Materials
<i>BN</i>	Base number, mg KOH/g oil
<i>C/Co</i>	Relative concentration of ions
<i>D</i>	Core diameter, cm
<i>DI</i>	Deionized water
<i>EOR</i>	Enhanced oil recovery
<i>IFT, <math>\sigma</math></i>	Interfacial tension, mN/m
<i>IOR</i>	Improved oil recovery
<i>L</i>	Core length, cm
<i>OOIP</i>	Original oil in place
<i>PV</i>	Pore volume, $cm^3$
<i>SC</i>	Synthetic crude oil
<i>SK</i>	Stevens Klint
<i>SW</i>	Synthetic seawater
<i>SW0NaCl</i>	Modified Synthetic seawater with reduced NaCl
<i>SW0T</i>	Synthetic seawater without $SO_4^{2-}$
<i>SW1/2T</i>	Synthetic seawater in which the concentrations of $SCN^-$ and $SO_4^{2-}$ is 0.012 mol/l respectively
<i>SW4S0NaCl</i>	Modified synthetic seawater with reduced NaCl and with 4 times the concentration of sulfate
$S_{oi}$	Residual oil saturation, %
$S_{wi}$	Initial water saturation, %
<i>TDS</i>	Total dissolved solids, g/l
$T_{im}$	Imbibing temperature, °C
<i>USBM</i>	United State Bureau of Mines
<i>VBOS</i>	Artificial formation brine with no $SO_4^{2-}$
<i>WI</i>	Chromatographic wettability index
$\mu$	Viscosity, cp
$\Phi$	Porosity, %
$\Delta\rho$	Density difference between oil and water, $g/cm^3$

# Contents

Acknowledgements.....	i
Abstract.....	ii
Abbreviations and symbols.....	iii
Contents.....	iv
1 Introduction.....	1
1.1 Introduction.....	1
1.2 Project objectives.....	3
2 Theory.....	4
2.1 Carbonates.....	4
2.1.1 Chalk.....	4
2.2 Oil recovery.....	5
2.2.1 Primary recovery.....	5
2.2.2 Secondary recovery.....	6
2.2.3 Tertiary recovery/EOR processes.....	6
2.3 Fluid displacement forces.....	7
2.3.1 Gravity forces.....	8
2.3.2 Capillary forces.....	8
2.3.3 Viscous forces.....	11
3 Wettability.....	13
3.1 Classification of wettability.....	13
3.2 Mechanisms of wetting alteration.....	15
3.3 Wettability of carbonate reservoirs.....	16
3.4 Methods of wettability measurement.....	16
3.4.1 Contact angle.....	17
3.4.2 Amott method.....	18
3.4.3 USBM method.....	20
3.4.4 Chromatographic wettability test.....	22
3.5 Spontaneous imbibition.....	23
3.6 Seawater as a wettability modifier in chalk reservoirs.....	24
4 Materials and Methods.....	26
4.1 Materials.....	26
4.1.1 Core materials.....	26
4.1.2 Analytical methods.....	26

4.1.3 Oil samples.....	27
4.1.4 Brines .....	28
4.2 Core preparation.....	29
4.3 Spontaneous imbibition tests .....	31
4.4 Chromatographic wettability test.....	33
5 Results and Discussion .....	35
5.1 Spontaneous imbibition at 90°C. ....	35
5.2 Spontaneous imbibition at 70°C .....	37
5.3 Chromatographic wettability test analyses.....	38
6 Conclusions.....	41
References.....	42
Appendix A .....	49
Appendix B .....	55

# 1 Introduction

## 1.1 Introduction

Carbonate rocks account for about 50 % of the world's proven oil reserves and many of the carbonate reservoirs are naturally fractured (Roehl and Choquette, 1985; Høgnessen et al., 2005). The formations are characterized by heterogeneous porosity and permeability distributions. In the case of low-porosity and low-permeability carbonate rocks (more specifically, the rock matrices), the fluid flow in the reservoir can be completely dependent on the fracture network. The rock matrix only plays a source role analogous to tight-sand formations and natural-gas flow. Fracture networks can cause uneven sweeping of the reservoir, leading to early breakthrough of injected fluids in the producing wells and resulting in low recovery factors. The abundance of carbonate reservoirs has been the subject of numerous studies attempting to characterize their heterogeneities. Also different types of fractured reservoirs are classified, and how rock and fluid properties influence ultimate oil recovery is determined (Manrique et al., 2007; Roehl and Choquette, 1985).

In contrast to sandstone reservoirs, literature data show that about 80-90 % of the world's carbonate reservoirs are preferentially oil-wet and they exhibit negative capillary pressure (Høgnesen et al., 20005). Also according to Chillingar and Yen (1983), experimental survey on 161 samples from carbonate rocks indicated that 15 % were strongly oil-wet, 65 % were oil-wet, 12 % were in the intermediate class and 8 % were water-wet. Wettability affects fluid distribution and flow in the reservoir during production (Anderson, 1986b). And for fractured carbonate reservoirs, wettability has widely been described as an important factor to consider for waterflooding to increase oil recovery (Tong et al., 2002; Morrow and Mason, 2001; Zhou et al., 2000; Hirasaki et al., 2004). The wettability depends both on the nature of the solid and the fluid properties; both oil and the initial brine (Cuiec 1984). Clean chalk is naturally water-wet, but crude oil may rupture the water film. The surface active components (carboxylic materials) of the crude oil can adsorb onto the rock surface, rendering it oil-wet as described by (Legends, et al., 1998; Kovscek et al., 1993; Kaminsky and Radke, 1998). The wetting nature of a carbonate reservoir determines the potential of improved oil recovery by water injection, especially if the formation is highly fractured. This is often the case for chalk formations. The initial wetting state is mostly governed by the properties of the crude oil, where the acid number, AN, appeared to be a crucial parameter. The reservoir temperature plays a minor role as a wetting parameter. Improved oil recovery by water injection decreases as the water-wetness decreases due to decrease in spontaneous imbibition (Austad et al., 2005). In a water-wet to mixed-wet formation, injected water may imbibe into the matrix blocks spontaneously (Torsæter, 1984). However, in an oil-wet rock, spontaneous imbibition into the matrix blocks may not be possible due to small or negative capillary pressure. In fractured oil-wet reservoirs, the injected water will advance in the high

permeable fractures resulting in early water breakthrough and low oil recovery (Al-Hadhrami and Blunt, 2000).

Furthermore, many researchers had demonstrated that the surfactant flooding could enhance oil recovery from fractured carbonates. This is due to the combined effects of reduction of water-oil-interfacial tension (IFT) and wettability alteration of the carbonates to a more water-wet condition (Milter and Austad, 1996; Austad et al., 1998; Spinler et al., 2000; Standnes and Austad, 2000b; Hirasak and Zhang, 2003; Seethepall et al., 2004). Flooding with cationic surfactants is most effective because they bear the same charge (positive charge) as the surface of the carbonates (Zhang, 2006). Strand et al. (2003) further documented that the wettability alteration process is catalyzed by the presence of sulfate ion,  $\text{SO}_4^{2-}$ . Sulfate can adsorb on the carbonates surface due to its strong affinity, and reduces the positive charge density. However, the reduction of IFT by the surfactant will decrease the spontaneous imbibition rate and the result is a slow oil recovery process (Zhang, 2006). The greatest setback to application of the chemical flooding in the fractured carbonate reservoirs is of economic consideration. The use of surface active additives like cationic surfactants of the quaternary ammonium type,  $(R-N(CH_3)_3)^+$ , is very expensive. Thus, seawater flooding became an attractive alternative because it is cheap and readily available.

Water injection for both pressure maintenance and oil displacement is the most important secondary recovery method in sandstones but has also been implemented with outstanding success in some carbonate reservoirs (Shariatpanahi et al., 2010). A typical example is the successful seawater injection into the Ekofisk field in the North Sea. The reservoir is a mixed-wet and low permeable naturally fractured chalk formation (Thomas et al., 1987). This great success gave impetus to many research programs to evaluate the interaction between the carbonate rock and the injected seawater. The mechanism involving wettability alteration and improved spontaneous imbibition of water into the matrix blocks are now understood. Previous studies had shown that sulfate was observed to catalyze the wettability alteration process using cationic surfactants. Seawater contains sulfate, and the concentration is nearly twice the concentration of calcium (Høgnesen et al., 2005). Recent laboratory studies (Høgnesen et al., 2005; Austad et al., 2007; Zhang et al., 2007) had demonstrated that seawater contained potential determining ions ( $\text{SO}_4^{2-}$ ,  $\text{Ca}^{2+}$  and  $\text{Mg}^{2+}$ ). These ions in proper concentration could promote wettability modification to a more water-wet condition. It was also observed that the spontaneous imbibition of water into the matrix block was enhanced, and increased oil recovery was observed as the temperature increased. Furthermore, Høgnesen et al. (2005) pointed out that the oil recovery by spontaneous imbibition of water into neutral to preferential oil-wet carbonate cores increased as the concentration of sulfate and temperature increased. They also determined the affinity of sulfate towards the chalk surface at different temperatures using the chromatographic separation between a tracer,  $\text{SCN}^-$ , and sulfate. The area between the effluent curve of the tracer and sulfate is a measure of the affinity of the sulfate towards the chalk sulfate (Strand et al., 2006). The chemical mechanism involved in the wettability alteration of carbonates by seawater is now clearly understood and documented (Zhang et al., 2007). It is the mutual chemical interaction between  $\text{SO}_4^{2-}$ ,  $\text{Ca}^{2+}$  and  $\text{Mg}^{2+}$ , at the chalk surface that is responsible



for removing the strongly adsorbed carboxylic material from the rock surface. Thus, the criteria for seawater to act as a wettability modifier, is that the surface active ions have strong affinity for the chalk surface. Their chemical reactivity increases as the temperature increases. It was observed experimentally that  $Mg^{2+}$  was able to substitute  $Ca^{2+}$  on the chalk surface at temperatures above  $90^{\circ}C$ . Strand et al. (2008) also observed that limestone reservoir reacted chemically in the same manner as chalk towards the potential determining ions, although the reactivity was lower than for chalk. Chalk is a pure biogenic rock with a much larger surface area compared to limestone.

The main goal of water-based EOR in carbonates is to imbibe water into the matrix and with that displace the oil into the fractures where it is further transported to the producer (Punternold, 2008).

Normally, reservoir engineers want to remove sulfate from the injected water in order to prevent souring ( $H_2S$  production) and scale problems ( $BaSO_4$ ,  $SrSO_4$ , etc). It is no doubt that supply of additional sulfate to the injected fluid can enhance these problems, but significantly increased oil recovery can justify for the extra cost of inhibitors (Høgnesen et al., 2005)

## 1.2 Project objectives

The main objective of this project is the optimization of the salinity and the ionic composition of seawater to improve oil recovery from chalk. This will be investigated by the spontaneous imbibition (SI) tests at  $90$  and  $70^{\circ}C$  respectively. The chromatographic wettability test is used to determine the water-wet surface area of the chalk cores after the SI tests.

Strand (2005) studied the effect of brine salinity on the SI process, with the brine without sulfate. The imbibition rate and the oil recovery decreased as the salinity of the imbibing brine increased. Fathi et al. (2010) studied the effect of modifying the salinity and the ionic composition of SW at different temperatures;  $100$ ,  $110$  and  $120^{\circ}C$ . By the reducing the concentration of NaCl in SW, both imbibition rate and ultimate oil recovery increased significantly. Also, a decrease in oil recovery was observed when increasing the concentration of NaCl relative to SW. It was also observed that wettability alteration was not a low salinity effect, shown by a drastic decrease in oil recovery when seawater was diluted with deionized water.

In this work, the concentrations of  $Ca^{2+}$  and  $Mg^{2+}$  in seawater are kept constant. Both cations and anions in seawater mutually compete with each other. By reducing NaCl in seawater, the surface active ions ( $SO_4^{2-}$  and  $Ca^{2+}$ ) will have easier access to the chalk surface. Also, increasing the concentration of sulfate, which has a catalytic effect on the wettability alteration mechanism, increases both imbibition rate and ultimate oil recovery.

## 2 Theory

### 2.1 Carbonates

The carbonate rocks comprise mainly limestones and dolomites. The Sedimentary rocks containing more than 50 % of carbonate minerals are defined as carbonates. All minerals containing the anion,  $CO_3^{2-}$ , are classified as carbonates. Limestone is commonly defined as the sedimentary rock containing more than 50 % of the mineral, calcite ( $CaCO_3$ ). Chalk is a special type of limestone. Dolomites contain more than 50 % of the mineral dolomite, ( $CaMg(CO_3)_2$ ) (Strand, 2005). Also, the carbonate rocks are grouped as biogenic, biochemical and organic sediments (Tucker ,2001 ).There origin may be detrital from debris, of reef type, chemical precipitation of bicarbonate, or from marine mud (Cossé, 1993).

The economic importance of carbonate rocks is due to their rich organic content and good reservoir properties. The estimated 40-60 % of the world's total hydrocarbon production is from carbonate rocks (Flügel, 2004). Many of the biggest carbonate reservoirs occur in the Middle East. Other areas in which the rock delivers large quantity of oil and gas are ; West Canada, Mexico, Texas (USA), Norway (Central North Sea), Poland, Kazakhstan, Western and Southern China, Iran and Libya (Gluyas and Swarbick, 2004).

#### 2.1.1 Chalk

Chalk is a special case of carbonates and it is formed by the stacking of small single-cell algae. These small single-cell algae are called coccoliths (Cossé, 1993). The rock is composed primarily of calcite and is very susceptible to fracture. During sedimentation and subsequent diagenesis, most of the coccoliths disintegrate to form the characteristic mixture of intact coccoliths, fragments and grains. Pelagic chalk diagenesis is the way the calcite skeletons of algal organisms, which provide the original material that becomes chalk ,alter over geological time after settling on the ocean flow .Single chalk grains have a general size of  $1\mu m$ , which explains the large surface area of about  $2 m^2 / g$  (Røgen and Fabricius,2002). The microstructure of chalk is of great importance. The presence or absence of an organic coating on the chalk particles has consequences for wetting behaviour (Andersen, 1995).

Chalk is an important type of reservoir rock in the North Sea area, e.g., Ekofisk and Valhall (Zhang, 2006). The porosity of chalk is rather high, but the permeability is low or very low, about 1 mD (Cossé, 1993). Chalk fields are generally of three types. Many are anticlines formed over salt dome and others are formed by salt piercements. Generally, these forming mechanics give rise to fractures (Andersen, 1995).

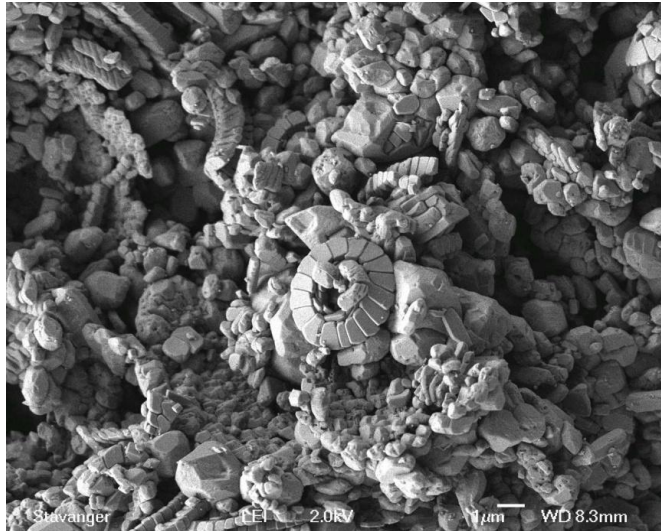

**Figure 2.1:** Picture of chalk, taken by a scanning electron microscope, showing coccolithic rings, fragments and pore space.

## 2.2 Oil recovery

Oil recovery is traditionally subdivided into three stages: primary, Secondary, and tertiary. Many a time, reservoir production operations are not conducted in the specified order that tertiary process may be applied at secondary stage instead of waterflooding. Thus, the term “tertiary recovery” fell into disfavour in petroleum engineering literature and the designation of “enhanced oil recovery” (EOR) became more accepted. Another descriptive designation normally used is “improve oil recovery” (IOR), which includes EOR but also a broader range of activities, like reservoir characterization, improved reservoir management, and infill drilling (Green and Willhite, 1998). The Norwegian Petroleum Directorate (1993) defined IOR as: “Actual measures resulting in an increased oil recovery factor from a reservoir as compared with the expected value at a certain reference point in time.”

### 2.2.1 Primary recovery

Primary oil recovery refers to simple pressure depletion where only reservoir energy, through different mechanisms, is used to extract the oil (Castor et al., 198; Farouq-Ali and Stahl, 1970). These natural energy sources are; solution-gas drive, gas-cap drive, natural water drive, fluid and rock expansion, and gravity drainage. The particular mechanism of lifting oil to the surface, once it is in the wellbore is not a factor in the classification scheme (Green and Willhite, 1998). The recovery factor after this depletion period is usually low, and normally, only 5-30 % of the original oil in place (OOIP) can be produced (Baviere, 1991) .

### **2.2.2 Secondary recovery**

Secondary recovery is normally implemented when the reservoir natural energies are not sufficient to produce hydrocarbon. This involves injection of water or gas, either for pressure support or for displacement of oil towards the production wells. About 30-70 % of OOIP is left unproduced after the process (Baviere, 1991). Gas injection is either into a gas cap for pressure maintenance and gas-cap expansion or into oil column wells. In this process, oil is displaced immiscibly according to relative permeability and volumetric sweepout considerations (Green and Willhite, 1998).

### **2.2.3 Tertiary recovery/EOR processes**

Unfavourable reservoir characteristics such as heterogeneous rock properties (fractures, layers with large permeability contrasts, impermeable layers), unfavourable wettability conditions, or capillary trapped and bypassed oil, results in areas of the reservoir not flooded by the injected fluid. Approximately 30-70 % of OOIP in the reservoir is left after these conventional secondary oil recovery processes (Baviere, 1991; Lake, 1989). It is the residual oil that is left in the reservoir after the secondary recovery that is the target for EOR processes. Thus, the purpose of initiating tertiary oil recovery processes is to extend lifetime of oil reservoirs which are approaching economical limit by support of waterflooding or other conventional methods (Strand, 2005). Tertiary processes use miscible gases, chemicals, and/or thermal energy to mobilize and displace additional oil after the secondary recovery processes become uneconomical (Green and Willhite, 1998). EOR is defined by Baviere (1991) as: *“EOR consists of methods aimed at increasing ultimate oil recovery by injecting appropriate agents not normally present in the reservoir, such as chemicals, solvents, oxidizers and heat carriers in order to induce new mechanisms for displacing oil.”* Zhang (2006) also proposed the definition of EOR as any method, which is aiming to improve the fluid flow by means of changing physical property of the reservoir rock or fluids, including wettability, interfacial tension, fluid density, viscosity, permeability, porosity, pore size, etc.

Green and Willhite (1998) classified EOR processes into five categories: mobility-control, chemical, miscible, thermal, and other processes such as microbial EOR.

#### **2.2.3.1 Mobility-control processes**

These processes primarily involve maintaining favourable mobility ratios ( $M$ ) to improve the magnitude of macroscopic displacement efficiency. Examples are polymer-augmented waterflooding and reducing gas mobility with foams. By modifying the viscosity of water by addition of polymer, a favourable mobility ratio ( $M < 1$ ) is maintained between the injected polymer solution and the oil/water bank being displaced ahead of the polymer. This results in a more uniform volumetric sweep of reservoir, both vertically and areally.

### **2.2.3.2 Chemical processes**

The EOR processes involve injection of specific liquid chemicals such as surfactants and alkaline agents. They also require phase-behaviour properties that results in decrease in interfacial tension (IFT) between the displacing liquid and oil. Examples are surfactant/polymer processes and alkaline flooding. The surfactants are used to obtain ultralow IFT. The process has the potential to increase both microscopic and macroscopic displacement efficiency due presence of polymer mobility buffer. However, the cost of surfactant is very high, making the process economically unattractive.

### **2.2.3.3 Miscible processes**

The primary objective of the miscible processes is to inject fluids such as carbon (IV) oxide and hydrocarbon solvents .These fluids directly mix with the oil or generate miscibility in the reservoir through composition alteration. The fluid Phase behaviour is very important in these processes. Oil is displaced to the production well by fluids which form a single phase at first contact or through modification of composition of the injected phase or oil phase, as fluids move through the reservoir.

### **2.2.3.4 Thermal processes**

These are based on the injection of thermal energy or the in-situ generation of heat. The alteration of oil viscosity, favourable phase behaviour, and in some cases, chemical reaction, are the primary mechanisms leading to improve oil recovery. They are further subdivided in to hot-water floods, Steam processes, and in-situ combustion (Green and Willhite, 1998).

### **2.2.3.5 Microbial EOR**

Microbial enhanced oil recovery (MEOR) represents the use of microorganisms to extract the remaining oil from reservoirs. This technique has the potential to be cost-efficient in the extraction of oil that is capillary trapped in the pores of reservoir rocks or in areas not swept by the classical or modern EOR methods (Lazar et al., 2007)

## **2.3 Fluid displacement forces**

Several forces act on the fluids flowing through a porous medium like an oil reservoir. The most important forces determining the flow of oil and water in porous media are viscous forces, gravity forces and capillary forces (Morrow, 1979). The active displacement forces in

the SI process are gravity and capillary forces. The interplay between these two forces is very important in situations where the wettability approaches neutral or the interfacial tension decreases. With a decrease in IFT of several orders of magnitude, the gravity forces may dominate the flow pattern in the porous media (Strand, 2005)

### 2.3.1 Gravity forces

The gravity forces during an oil production process are important especially in gas/oil systems with density difference between the fluid phases (Murty et al., 1987). The gravity forces are also important under low oil-water IFT conditions (Hornof and Morrow, 1987; Austad and Milter, 1997). These buoyancy forces are always present in a system of immiscible fluids and the lighter phase will experience a pressure in upward direction (Strand, 2005). The pressure difference between oil and water is expressed by equation 2.1 (Cole, 1969

$$\Delta P_g = \Delta \rho \cdot g \cdot H \quad (2.1)$$

Where:

- $\Delta P_g$  Pressure difference between oil and water due to gravity
- $\Delta \rho$  Density difference between oil and water
- $g$  Acceleration due to gravity
- $H$  Height of the liquid column

### 2.3.2 Capillary forces

The capillary forces have great influence on oil recovery efficiency, but the influence differs fundamentally for non-fractured and fractured reservoirs. Strong capillary forces during waterflooding will trap oil and cause relatively high residual oil saturation in a non-fractured reservoir (Anderson, 1987). Reduction in the oil-water IFT to remobilizing residual oil is in this case the preferred conditions (Taugbøl, 1995). In fractured reservoirs, spontaneous imbibition of water due to strong capillary forces is regarded as an important and necessary mechanism to attain high displacement efficiency (Strand, 2005). Capillary forces are often the strongest forces in a multiphase flow and the combination of all the active surface forces determines the capillary pressure in the porous rock (Skjæveland and Kleppe, 1992).

Because fluid/fluid interfaces are in tension, a pressure difference exists across the interface and this pressure is called capillary pressure (Green and Willhite, 1998). Capillary pressure is defined as the pressure of the non-wetting fluid minus the pressure of the wetting fluid (Strand, 2005). For oil/water systems, water is regarded as a wetting phase

$$P_c = P_o - P_w = P_{NW} - P_w \quad (2.2)$$

Where:

- $P_C$  Capillary pressure
- $P_{NW}$  Pressure of non-wetting phase at interface (o; oil)
- $P_W$  Pressure of wetting phase at interface (w; water)

### 2.3.2.1 Capillary pressure determination

The straight capillary is an idealistic and simplistic approximation to capillary phenomena in oil-bearing rocks. The complexity of the pore structure prohibits rigorous analytical examination. For a system of unconsolidated uniform spherical particles of definite sizes on the order of magnitude found in oil-bearing rock, an expression for the capillary pressure (equation 2.3) was developed by Plateau and has been called Laplace equation (Green and Willhite, 1998).

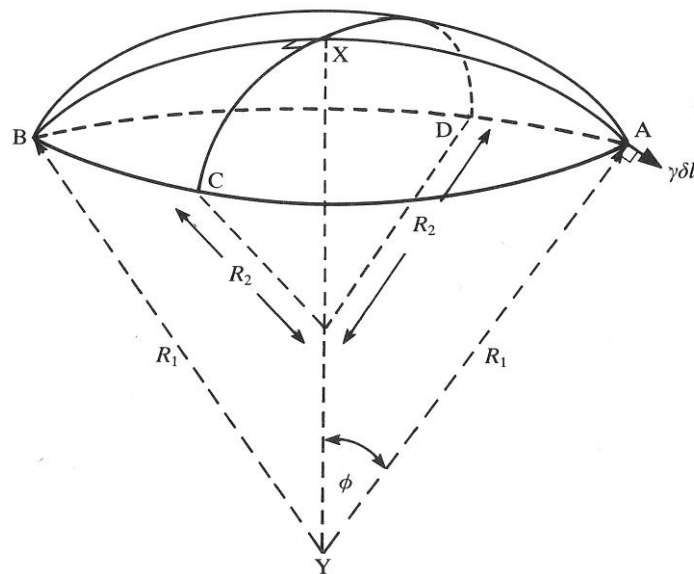

**Figure 2.2:** A section of a spherical particle, showing the radii of the curvature.  
After Hunter, (1996).

$$\Delta P = P_c = \sigma \left[ \frac{1}{R_1} + \frac{1}{R_2} \right] \quad 2.3$$

Where

- $\Delta P$  Pressure difference across the interface
- $\sigma$  Interfacial tension.
- $R_1, R_2$  Two principal radii

In a straight capillary,  $1/R_1$  and  $1/R_2$  are equal and are given by the radius of the capillary divided by the cosine of contact angle,  $r/\cos\theta$ . The cylindrical model is often used to idealize the complexity of a porous media (Figure 2.3).

The capillary pressure is given by equation 2.4, if we consider a cylindrical pore throat filled with oil and water, with water as the wetting phase (Strand, 2005).

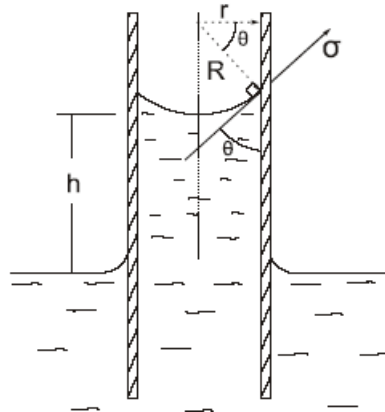

Figure 2.3: Idealized capillary pressure determination using cylindrical capillary tube model. After Mørk (2001).

$$P_c = \frac{2\sigma_{ow} \cos \theta}{r} \quad 2.4$$

Where:

- $r$  radius of the cylindrical pore channel
- $\sigma_{ow}$  Interfacial tension (IFT) between oil and water
- $\theta$  Contact angle measured through the water phase

From equation 2.4, the capillary pressure is related to the fluid/fluid IFT, the relative wettability of the fluids (through  $\theta$ ), and the size of the capillary ( $r$ ). The capillary pressure may be positive or negative; the sign merely expresses in which phase the pressure is lower. The phase with the lower pressure will always be the phase that preferentially wets the capillary (Green and Willhite, 1998). For the SI processes in oil-wet carbonate reservoir, the only parameter that can be altered to change the wetting of the rock is the contact angle. This is done by using seawater with the desired salinity and ionic composition as the imbibing brine.



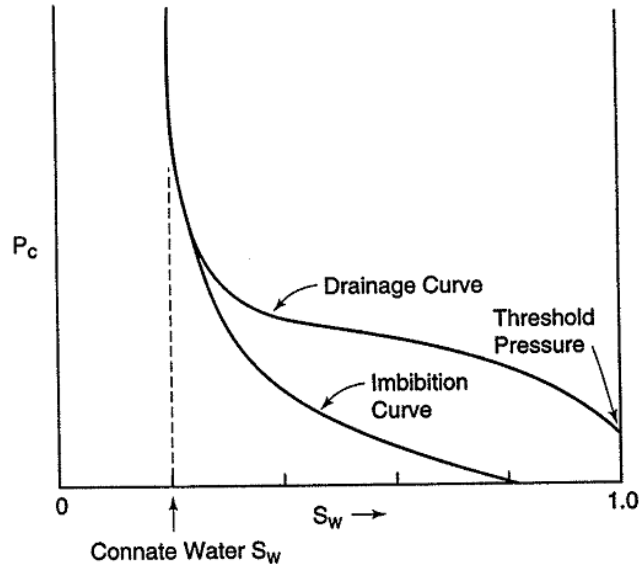

Figure 2.4: Typical capillary pressure curves for a reservoir rock, water-wet system (Green and Willhite, 1998).

### 2.3.3 Viscous forces

The viscous forces in a porous medium are reflected in the magnitude of the pressure drop that occurs as a result of flow of a fluid through the medium. They can be approximated by assuming that a porous medium is a bundle of parallel capillary tube. The pressure drop is given by Poiseuille's law.

$$\Delta P = -\frac{8\mu L\bar{v}}{r^2 g_c} \quad (2.5)$$

Where:

- $\Delta P$  Pressure across the capillary tube
- $L$  Capillary tube length
- $r$  Capillary tube radius
- $\bar{v}$  Average velocity in the capillary tube
- $\mu$  Viscosity of flowing fluid
- $g_c$  Conversion factor

The dimensionless grouping of variables which expresses the ratio of viscous to capillary forces is called the capillary number ( $N_{ca}$ ). Waterfloods typically operate at condition where  $N_{ca} < 10^{-6}$  and values on the order of  $10^{-7}$  are probably most common. From equation 2.6,  $N_{ca}$  increases either by increasing the flow rate of the displacing fluid, increasing the viscosity of the displacing fluid or reducing IFT between the displaced and displacing fluids (Green and Willhite, 1998).

$$N_{ca} = \frac{F_v}{F_c} = \frac{v\mu_w}{\sigma_{ow}} \quad (2.6)$$

Where:

- $F_v$  Viscous force
- $F_c$  Capillary force
- $v$  Interstitial pore velocity
- $\mu_w$  Viscosity of the water
- $\sigma_{ow}$  Interfacial tension between oil and water

## 3 Wettability

Wettability is the tendency of one fluid to spread on or adhere to a solid surface in the presence of other immiscible fluids (Anderson, 1986a). Wettability is an important determining factor in a multiphase flow in reservoir rock, fluid distribution and trapping (Strand, 2005). Fluid distributions in porous media are affected both by forces at fluid-fluid interfaces and fluid-solid interfaces. Usually, one phase is more strongly attracted to the solid than the other phase, when two immiscible fluids are placed in contact with a solid surface. The more strongly attracted phase is called the wetting phase. Also, rock wettability affects the nature of fluid saturations and the general relative permeability characteristics of fluid-rock system. The location of a fluid within the pore structure depends on the wettability of that phase (Green and Willhite, 1998).

The reservoir wettability is a critical parameter in many types of oil recovery processes. Recovery of oil by spontaneous imbibition of water into the matrix of fractured reservoirs is a frequently cited example. Ma et al. (1999) also noted that capillary pressure is the driving force in spontaneous imbibitions. Wettability remains the key factor in determining capillary driving force and the related imbibition rate.

### 3.1 Classification of wettability

Wettability can be classified as homogeneous when the rock surface has uniform molecular affinity to either water or oil. This is again split into strongly water-wet, strongly oil-wet, and Intermediate-wet categories.

For a strongly oil-wet rock, the oil will contact most of the rock surface and occupy the smallest pores and the water is in the middle of the larger pores. When this rock is waterflooded, the oil will remain as a film on the rock surface and in the smallest pores where water does not penetrate. The water will mainly flow through the rock in the larger pore channels as illustrated by Figure 3.1a.

On the other hand, if water contacts most of the rock surfaces and fills the smallest pores of the rock, we have a strongly water-wet rock. The oil is located in the center of the larger pores. If the rock is waterflooded, a snapping phenomenon may occur, leaving oil globules trapped in the center of the large pores, as shown in Figure 3.1b (Strand, 2005). Intermediate wettability occurs when both fluid phases tend to wet the solid, but one is only slightly more attracted than the other (Green and Willhite, 1998).

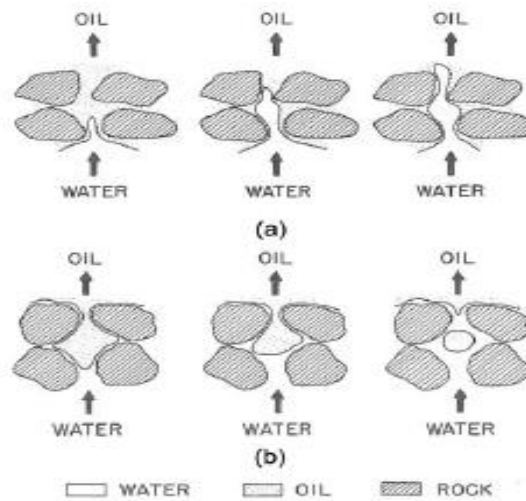

Figure 3.1: Displacement of oil by water for (a) Oil-wet rock, and (b) Water-wet rock. After Forrest (1980).

Moreover, the concept of intermediate wettability assumes that all portions of the rock have a slight but equal preference to being wetted by oil or water.

In contrast, the internal surface of the reservoir rock is composed of many minerals with different surface chemistry and adsorption properties, leading to variations in wettability. This heterogeneous wettability may be divided into fractional or mixed wet. In fractional wettability, (also called heterogeneous, spotted, or dalmatian) crude oil components are strongly adsorbed in certain areas of the rock. Thus, some portion of the rock is strongly oil-wet, while the rest is strongly water-wet. The mixed wet is a special type of fractional wettability when the rock has continuous water-wet and oil-wet regions (Salathiel, 1973; Strand, 2005). Mixed wettability results from a variation or heterogeneity in chemical composition of the exposed rock surfaces or cementing-material surfaces in the pores (Green and Willhite, 1998). In addition, both water and oil can spontaneously imbibe, in some mixed-wet or fractional wet system (Anderson, 1986b; Cuiec, 1999).

Furthermore, Green and Willhite (1998) gave a quantitative classification of wettability based on contact angles. Contact angle by convention, is measured through water phase and it is a measure of wettability.

From Figure 3.2, the solid is water-wet if  $\theta < 90^\circ$  and oil-wet if  $\theta > 90^\circ$ . A contact angle approaching  $0^\circ$  indicates a strongly water-wet system and an angle approaching  $180^\circ$  indicates a strongly oil-wet system. Intermediate wettability occurs when  $\theta$  is close to  $90^\circ$ .

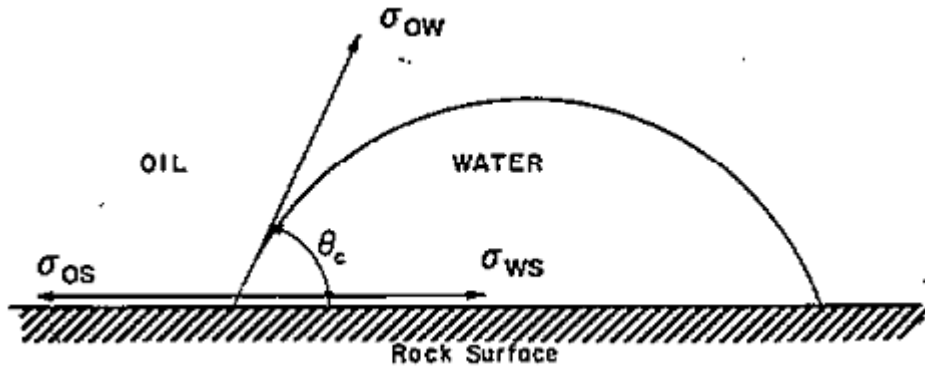

Figure 3.2: Wettability of the oil/water/rock system. After Raza et al. (1968).

Where :  $\theta$  = Contact angle,  $\sigma_{ow}$  = IFT at oil-water interface,  $\sigma_{os}$  = IFT at oil-solid interface ,  $\sigma_{ws}$  = IFT at water-solid interface .

### 3.2 Mechanisms of wetting alteration

Originally, all reservoir rocks are thought to be water-wet. Their wettability could be altered by the adsorption of polar compounds and/or a deposition of organic matter that was originally in the crude oil (Anderson, 1986a). The degree of change in wettability can be determined by the interaction of the oil components, the mineral surfaces, and brine chemistry (Anderson 1986a; Buckley, 2001).

Adsorption of surface-active polar compounds from the crude oil results in a less water-wet rock (Punternold, 2008). The main crude oil fractions affecting the wettability in porous rock are the asphaltenes and resins (Buckley 1996; Xie et al., 2000). Asphaltenes are large complex molecules, somewhat polar, with molecular weights in the range 600-300,000 (Rønningsen, 1991). Resins are smaller molecules than asphaltenes, but have in general higher content of the polar elements - nitrogen, sulphur, and oxygen (NSO-compounds). They are in general more polar than the asphaltenes (Speight, 1999; Strand, 2005). These polar compounds are in either acidic or basic in nature (Anderson, 1986b; Cuiec, 1984). Skauge et al. (1999) also demonstrated that both acid and base number increased with increasing asphaltene content.

The mechanism for which a given crude oil to alter the rock wettability can be predicted according to the so-called G-AB parameters (API gravity, acid number, and base number), together with the rock materials (Buckley and Liu, 1998). In addition, Punternold (2008) noted that the ability of the different polar compounds to alter the rock wettability depended on the rock type (carbonate or silica). These rocks respond differently to acidic and basic materials due to opposite surface charges. Standnes and Austad (2000a) observed that the acid number of the crude oil is one of the crucial factors for the wetting state of carbonate rock. The water-wetness decreases with increasing acid number. The carbonate rocks are typically more oil wet than sandstone cores (Treiber et al., 1972). This is because the carbonate surface is generally positively charged below pH 8 to 9 (Pierre et al., 1990), and will readily absorb negatively charged acidic groups (Standnes and Austad, 2003). In

contrast, sandstone is negatively charged above  $\text{pH} = 2$  (Menezes et al., 1989), and is able to adsorb positively charged basic components in oil. The experimental evidence also showed that the carboxylic material present in crude oil is the most strongly adsorbed polar organic components onto the carbonate surface (Thomas et al., 1993). This is regarded as the main cause of oil-wetness of most carbonate reservoirs.

Temperature is also an important parameter influencing the wettability alteration process (Hjelmeland and Larrondo, 1986; Wang and Gupta, 1995, Liu and Buckley, 1997). However, the temperature effect on oil wetting is still not clearly understood.

The chemistry of the formation brine is another important factor influencing rock wettability. This is because the pH and salinity of the brine strongly affects the surface charge of the rock and fluid interfaces. It also affects the adsorption of ions. The presence of multivalent cations in the brine can affect the rock wettability (Anderson, 1986a). A carbonate reservoir with formation water that contains  $\text{SO}_4^{2-}$  ion will be preferentially water-wet (Punternvold, 2008).

### **3.3 Wettability of carbonate reservoirs**

As mentioned earlier, contrary to the sandstone reservoirs, about 80-90 % of the world's carbonate reservoirs are preferentially oil-wet. They exhibit negative capillary pressure (Høgnesen et al., 2005). The wettability of a reservoir is an important parameter affecting fluid distribution, location and flow of oil and water in the reservoir (Anderson, 1986a).

The fractured nature of carbonate reservoirs poses a great challenge during production because injected water will flow through fractures to the production well, bypassing most of the oil in the matrix blocks. If the rock is water-wet, water will imbibe spontaneously from the fractures into the matrix blocks and expel the oil through the fracture network. The spontaneous imbibition of water is not possible for oil-wet reservoir rock due to negative capillary pressure. Thus, the EOR potential for carbonates is very high due to presence of fractures, low displacement efficiency and unfavourable wetting conditions (Strand, 2005).

### **3.4 Methods of wettability measurement**

Many different methods have been proposed for measuring the wettability of a system (Anderson, 1986b). They include quantitative methods- contact angles, Amott (imbibition and forced displacement), and USBM wettability method. The qualitative methods include: imbibition rates, microscope examination, flotation, glass slide method, relative permeability curves, capillarimetric method, displacement capillary pressure, reservoir logs, nuclear magnetic resonance, and dye adsorption.

In addition, a new quantitative wettability test method for carbonates (Strand et al., 2006), based on chromatographic separation between sulfate ions,  $\text{SO}_4^{2-}$ , and thiocyanate,  $\text{SCN}^-$ , as a tracer is described. There is no single accepted method and many of the

wettability measurements are also imprecise, particularly close to neutral wettability. One method may show that a core is mildly oil-wet, while another shows that a core is mildly water-wet (Anderson, 1986b)

### 3.4.1 Contact angle

The contact angle method is the best measure of the wettability when pure fluids and artificial cores are used (Anderson, 1986b). A typical oil/water/solid system is shown in Figure 3.2 and 3.3, where the surface energies in the system are related by Young's equation. By convention, the contact angle,  $\theta$ , is measured through the water and the interfacial energy  $\sigma_{ow}$  is equal to  $\sigma$ .

$$\sigma_{ow} \cos \theta = \sigma_{os} - \sigma_{ws} \quad (3.1)$$

Contact angles can be either static or dynamic. Static contact angles are formed with a surface under no applied force other than gravity. Dynamic contact angles are distorted from the static case by an applied force and can be advancing or receding. Advancing contact angles are formed at the front of the encroaching wetting phase, whereas receding contact angles are formed at the front of the encroaching non-wetting phase (Strand, 2005).

The commonly used methods in the petroleum industry are the sessile drop method and the modified sessile drop method (Anderson, 1986b). The sessile drop method uses a single flat, polished mineral crystal.

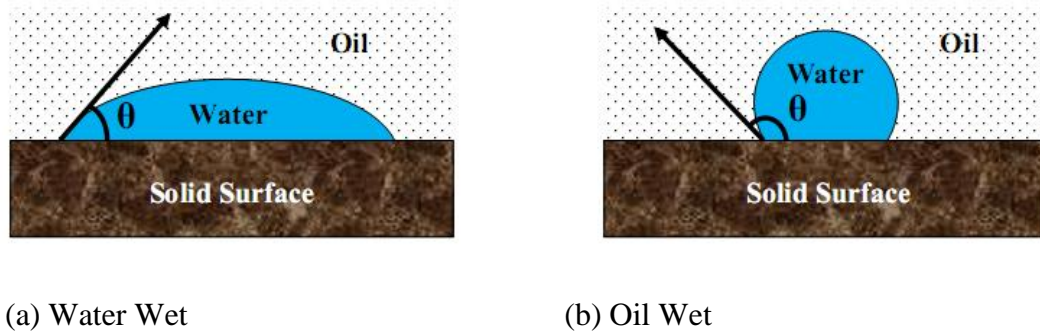

**Figure 3.3:** Contact angle measurements through the water phase. After Raza et al. (1968).

The modified sessile drop method uses two flat, polished mineral crystals that are mounted parallel to each other on adjustable posts. An oil drop is placed between the two crystals so that it contacts a large area of each crystal (Figure 3.4a). After the oil/crystal interface has aged for a few days, the two crystals are displaced parallel to each other. This shifts the oil drop and allows brine to move over a portion of the surface previously covered with oil, and this is shown in Figure 3.4b. The contact angles measured in this manner are referred to as water-advancing contact angles.

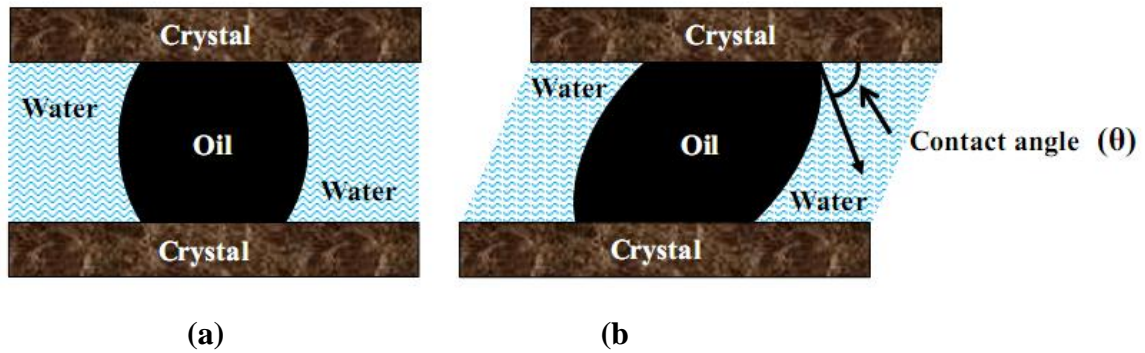

**Figure 3.4:** Principle of advancing contact angle measurements.  
After Craig (1971).

One of the problems in contact-angle measurement is hysteresis, caused by a surface having many different stable contact angles. Hysteresis is the difference between the advancing and receding contact angles. The contact-angle hysteresis can be caused by surface roughness, surface heterogeneity, and surface immobility on a macromolecular scale. Another setback is that contact angle cannot take into account the heterogeneity of the rock surface. Furthermore, no information can be gained about the presence or absence permanently attached organic coatings on reservoir rocks (Anderson, 1986b). Contact angle provides a direct macroscopic measure of wettability of flat surfaces, but cannot be measured in porous media with different mineral and surface chemistry (Strand, 2005).

### 3.4.2 Amott method

Amott test (Amott, 1959), is one of the commonly used methods of characterizing wettability of a porous medium (Ma et al., 1999). It combines imbibition and forced displacement (of water and oil) to measure the average wettability of a core (Anderson, 1986b). The method is based on the fact that the wetting fluid generally imbibe spontaneously into the core, displacing the nonwetting one. Forced displacement is either by centrifuging, as originally proposed by Amott, or by waterflooding (Cuie, 1984). No stepwise capillary pressure values are measured during the test. The Amott wettability measurement consists of 5 steps which include: (1) immerse the core in oil, and measure the volume of water displaced by the spontaneous (free) imbibition of oil after 20 hours; (2) centrifuge the core in oil until irreducible water saturation (IWS) is reached, and measure the total amount of water displaced, including the volume displaced by spontaneous imbibitions; (3) immerse the core in brine, and measure the volume of oil spontaneously displaced by imbibitions of water after 20 hours; and (4) centrifuge the core in oil until residual oil saturation (ROS) is reached, and measure the total amount of oil displaced (Anderson, 1986b). Figure 3.5 shows a complete cycle for Amott method.



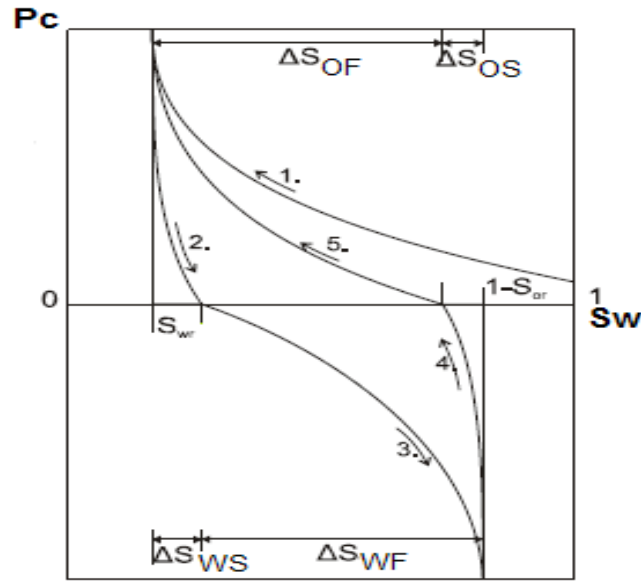

**Figure 3.5:** Capillary pressure curve for Amott and Amott-Harvey test method.

The test cycle is divided into five segments:

1. Primary drainage of water by oil to establish initial water saturation,  $S_{wi}$
2. Spontaneous imbibition of water
3. Forced imbibition of water
4. Spontaneous drainage of oil
5. Forced drainage of oil

The modified Amott wettability test, called Amott-Harvey relative displacement index ( $I_{AH}$ ) is used by some researchers (Anderson, 1986b). This method offers a single value that can be used for mathematical modeling.

The Amott wettability indices to water ( $I_w$ ) and oil ( $I_o$ ) are defined respectively as:

$$I_w = \frac{\Delta S_{WS}}{\Delta S_{WS} + \Delta S_{WF}} \quad (3.2)$$

And

$$I_o = \frac{\Delta S_{OS}}{\Delta S_{OS} + \Delta S_{OF}} \quad (3.3)$$

Where:

$\Delta S_{WS}$ : the saturation change during a spontaneous imbibitions of water;

$\Delta S_{WF}$ : the saturation change during a forced imbibition of water;

$\Delta S_{OS}$  : the saturation change during a spontaneous drainage of oil;

$\Delta S_{OF}$  : the saturation change during a forced drainage of oil.

The Amott-Harvey relative displacement index is the displacement-by-water ratio minus the displacement-by-oil ratio:

$$I_{AH} = I_w - I_o \quad (3.4)$$

Thus, this combines the two ratios into a single wettability index that varies from +1 for complete water wetness to -1 for complete oil wetness. Cuiec (1984) further gave the index ranges as:  $+0.3 \leq I_{AH} \leq 1$  for water-wet system,  $-0.3 < I_{AH} < 0.3$  for intermediate wet system, and  $-1 \leq I_{AH} \leq -0.3$  for oil-wet system. The Amott test gives a defined scale for the wettability. The test is widely used and measurement is easy to perform. However, Amott method is insensitive close to neutral wettability (Anderson, 1986b). It does not discriminate adequately between systems that give high wettability index to water (Ma et al., 1999).

### 3.4.3 USBM method

The USBM test (Donaldson et al., 1969) also measures the average wettability of the core. It has advantage over Amott wettability test because of its sensitivity close to neutral wettability. A minor disadvantage is that USBM wettability index can only be measured on plug-size samples because the sample must be spun in a centrifuge. Also, the USBM test also cannot determine whether a system has fractional or mixed wettability.

The USBM test compares the work necessary for one fluid to displace the other. Because of favorable free-energy change, the work required for the wetting fluid to displace the non-wetting fluid from the core is less than the work required for the opposite displacement. It has been shown that the required work is proportional to the area under the capillary pressure curve. Thus, if a core is water-wet, the area under the brine-drive capillary pressure curve (when the water displaces the oil) is smaller than area under the capillary pressure curve for the opposite displacement (Anderson, 1986b).

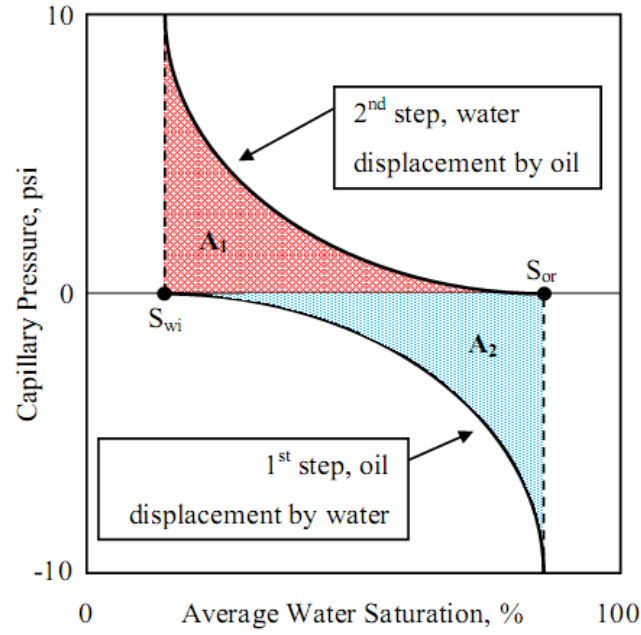

**Figure 3.6:** USBM wettability measurement (Donaldson et al. 1969)

In the USBM test, after spontaneous imbibition starting at  $S_{wi}$  is complete, the sample is then subjected to forced displacement of oil by centrifuging with the speed increased by increments, until capillary pressure of -10 psi is reached. A capillary pressure curve is derived from the centrifuge data, and the area under the forced imbibition curve,  $A_2$ , is determined, see Figure 3.6. The core sample is then submerged in oil. After spontaneous imbibition of oil is complete, the centrifuge method, as in the first step is used to measure the drainage curve for displacement of water by oil. In the second step, the capillary pressures and average saturations are measured until a capillary pressure of 10 psi is reached. The area under the drainage curve is designated as  $A_1$ . The USBM method uses the ratio of areas under the oil- and brine drive curves to calculate a wettability index ( $WI_{USBM}$ ) according to Eq. 3.5

$$WI_{USBM} = \log\left(\frac{A_1}{A_2}\right) \quad (3.5)$$

When  $WI_{USBM}$  is greater than zero, the core is water-wet, and when  $WI_{USBM}$  is less than zero, the core is oil-wet. A wettability index close to zero means that the core is neutrally wet. The larger the absolute value of  $WI_{USBM}$ , the greater the wetting preference (Anderson, 1986b).

### 3.4.4 Chromatographic wettability test

The new wettability test method for chalk was developed by Strand et al. (2006). This method is based on chromatographic separation between sulfate ions,  $\text{SO}_4^{2-}$ , and a non-adsorbing tracer, thiocyanate ( $\text{SCN}^-$ ). The oil saturated core is first flooded to residual oil saturation,  $S_{or}$ , with brine without a tracer and sulphate. The core is then flooded at constant rate with brine containing equal molar concentrations of  $\text{SO}_4^{2-}$  and  $\text{SCN}^-$ . The tracer breaks through earlier than sulfate due to adsorption of  $\text{SO}_4^{2-}$  onto water-wet the chalk surface. The effluent is collected with a fraction collector, and each fraction is analyzed for the amount of sulphate and thiocyanate. The relative ionic concentration is calculated and plotted against the pore volume injected. The area between the corresponding curves is calculated by the trapezoid method as shown in Figure 3.7. The area between the effluent curves for  $\text{SCN}^-$  and  $\text{SO}_4^{2-}$  is directly proportional to the water-wet surface area in the porous medium.

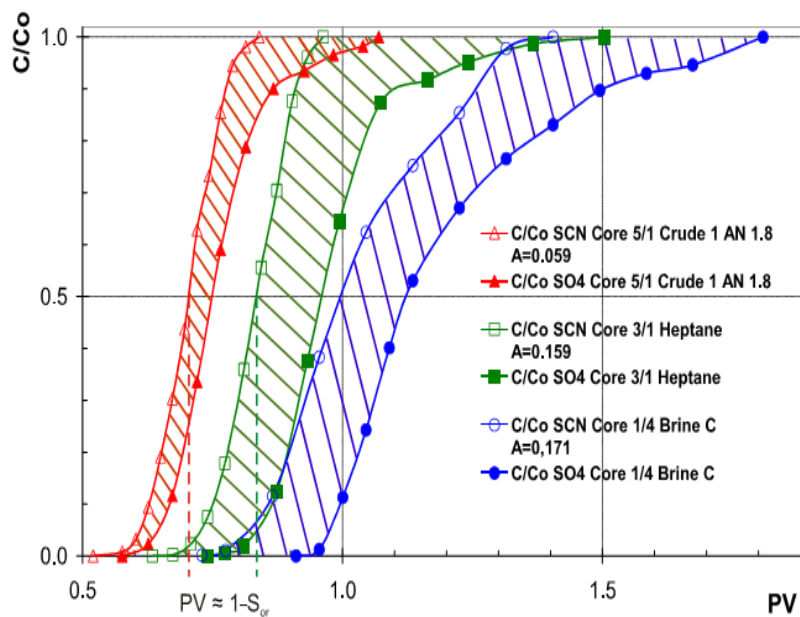

**Figure 3.7:** Schematic illustration of the chromatographic separation of sulfate and thiocyanate for a preferential oil-wet core. Completely water-wet conditions are assumed using heptane as oil or at 100 % water saturated conditions (Strand, 2005).

The new method offers an excellent way of evaluating the fractional water-wet area in chalk materials, independent of initial fluid saturations. It is also applicable to other carbonate reservoir rocks like limestone and dolomite. When compared to other traditional methods used to characterize the wettability of chalk, the new chromatographic method is fast. It can be run at residual oil saturations without performing any long-term imbibition test (Strand, 2005).

The new wetting index ( $WI_{NEW}$ ) is defined as:

$$WI_{New} = \frac{A_{wett}}{A_{Hep \tan e}}$$

Where:

$WI_{New}$  = Fraction of water-wetness

$A_{Wett}$  = The area between the thiocyanate and sulfate curves generated by flooding a core at  $S_{or}$

$A_{Hep \tan e}$  = The reference area between the thiocyanate and sulfate curves, generated by flooding a core assumed to be completely water-wet.

According to the definition of  $WI_{New}$  :

$WI_{New} = 1.0$  represents a completely water-wet system

$WI_{New} = 0.5$  represents neutral wettability

$WI_{New} = 0.0$  represents a completely oil-wet system.

### 3.5 Spontaneous imbibition

Spontaneous imbibition can be defined as the process by which one fluid displaces another from a porous medium as a result of capillary forces only. It has been widely studied because of its importance in oil recovery, with much emphasis on carbonate rocks. Water imbibition is fundamental to both waterflood and steamdrive performance in low permeability reservoir rocks such as diatomite and chalk. Imbibition is an immiscible displacement process whereby a non-wetting fluid within a porous medium, is spontaneously expelled by wetting fluid that surrounds the medium. Wetting fluid is drawn into the medium by capillary suction. This phenomenon is caused by the differential attraction forces between the pore walls and fluids. The spontaneous imbibition could be described by either a diffusion-like equation or a frontal-advance equation, depending on assumptions.

However, the rate of imbibition is primarily dependent on the rock permeability, pore structure, wettability, and the interfacial tension between the resident fluid and the imbibing phase. On a macroscopic scale, capillary imbibitions forces determine in part, how rapidly and easily a hydraulically fractured water injector injects water into a low permeability formation. They also determine at what rate the injected water propagates. In naturally fractured system with high degree of interconnectedness, imbibition forces must be strong for a waterflood to be successful. If they are not, water will propagate through the fracture network from injector to producer and the waterflood will fail.

### 3.6 Seawater as a wettability modifier in chalk reservoirs

Some of the previous work that investigated the spontaneous imbibition mechanism in chalk was performed with surfactants. Strand et al. (2003) discovered that sulfate ions present in the imbibing fluid catalyzed the wettability alteration process. The result initiated another work (Strand et al., 2006) to explore the potential of sulphate as a wettability alteration agent, using seawater as the imbibing fluid. Seawater contains a large amount of sulfate. The spontaneous imbibition tests showed that seawater was able to alter the wetting of chalk and improve oil recovery.

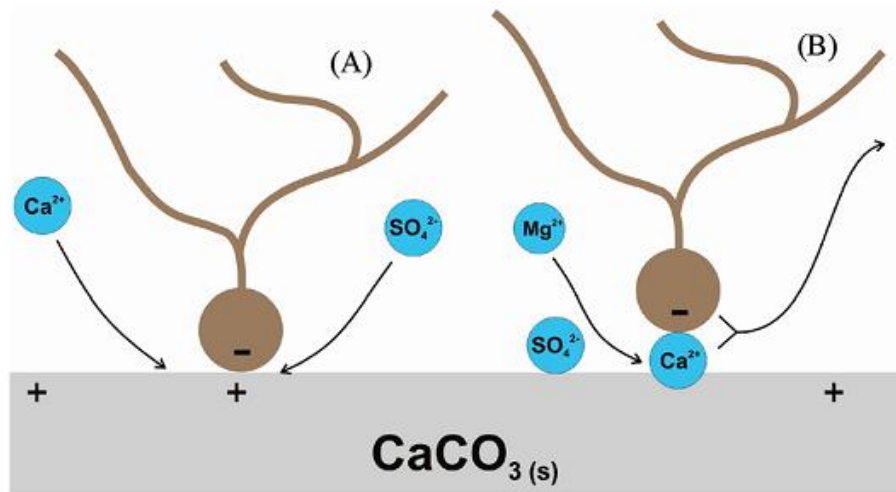

**Figure 3.8:** Suggested mechanism for the wettability alteration induced by seawater. A: Proposed mechanism when  $\text{Ca}^{2+}$  and  $\text{SO}_4^{2-}$  are active at lower temperature. B: Proposed mechanism when  $\text{Ca}^{2+}$ ,  $\text{Mg}^{2+}$  and  $\text{SO}_4^{2-}$  are active at high temperatures (Zhang, 2006).

The mechanism for seawater induced wettability alteration in chalk has been suggested by Zhang (2006), and is shown in Figure 3. The process is a classic example of surface chemistry. It is experimentally verified that the interactions between the active components,  $\text{Ca}^{2+}$ ,  $\text{Mg}^{2+}$ , and  $\text{SO}_4^{2-}$ , in seawater and the rock surface are responsible for the improvement in water wetness of chalk. When seawater which contains a lot of  $\text{SO}_4^{2-}$  is injected into a chalk reservoir,  $\text{SO}_4^{2-}$  will adsorb on the positively charged chalk surface and lower the positive charge density. Due to less electrostatic repulsion, more  $\text{Ca}^{2+}$  will co-adsorb and increase the concentration of  $\text{Ca}^{2+}$  close to the chalk surface. Thus, some of the strongly adsorbed carboxylic material is desorbed from the surface, as  $\text{Ca}^{2+}$  reacts with negatively charged carboxylic groups bonded to the chalk surface. The process is illustrated schematically in Figure 3.7A. It is observed experimentally that  $\text{Mg}^{2+}$  can substitute  $\text{Ca}^{2+}$  at chalk surface at high temperatures (see Figure 3.7B). The  $\text{Mg}^{2+}$  ion is able to displace  $\text{Ca}^{2+}$

linked to carboxylic groups on the chalk surface, provided that access is obtained through the aqueous phase. The combined effects remove the organic material, making the chalk surface to be less oil-wet.

In addition, the affinity of  $SO_4^{2-}$  towards chalk surface increases with temperature (Strand et al., 2006). By using the chromatographic separation, the area between  $SCN^-$  and  $SO_4^{2-}$  is a measure of the affinity of the sulfate towards the chalk surface. The concentration of sulfate present in the imbibing fluid and temperature are important determining parameters. The SI rate increases with increasing concentration of  $SO_4^{2-}$ , due to increased rate of diffusion of the ion towards the imbibing front. In effect, the ability of seawater to act as a wettability modifier of oil-wet chalk depends on the presence of the potential determining ions and temperature. And these ions could only be active in the aqueous phase, provided by the seawater. Thus, seawater can be modified to contain these ions in proper concentration to improve oil recovery from fractured chalk or limestone reservoirs.

## **4 Materials and Methods**

### **4.1 Materials**

#### **4.1.1 Core materials**

Outcrop chalk from Stevns Klint near Copenhagen, Denmark, was used as the porous medium. The chalk is of Maastrichtian age and highly porous. The material is homogeneous and composed mainly of fine-graded coccolithic matrix, similar to North Sea chalk oil reservoirs. The porosity is in the range of 44-50 %, with low permeability in the range of 1-2 mD. A single chalk grain has a general size of 1 $\mu$ m, and has large surface area of approximately 2 m<sup>2</sup>/g (Røgen and Fabricious, 2002).

#### **4.1.2 Analytical methods**

##### **Density measurements**

The density measurements of the oil samples were performed on an Anton Parr DMA 4500 Density Meter. The instrument can be found in Appendix A.3. The measurements were done at 20°C. The instrument was first cleaned with white spirit, and then with acetone. A small amount of the oil sample was injected gradually into the tube and the density was determined. The sample should be free of gas bubbles and the measurements were repeated to ensure accuracy.

##### **Viscosity measurements**

The viscosity measurements were performed on a Physica UDS 200 Universal Dynamic Spectrometer (see Appendix A.4). The measurements were done at 20°C. The shear rates were set between 10-1000 1/s. and the instrument accuracy was tested deionized (DI) water. About 2.2 ml of the oil sample fluid was placed on the metal plate. Then, the apparatus was set in measuring position with the plates close to each other. The viscosity of the oil was determined through shear stress/shear rate relation.

##### **Acid and base number determination**

A Mettler Toledo DL55 automatic titrator was used to measure the acid and base number of different oil samples. The methods used, developed by Fan and Buckley (2007), involved potentiometric titrations using an internal standard. They are the modified versions of ASTM D2896 for base number (AN) and ASTM D664 for acid number (AN) titration. See Appendix A.5 for more details.



### 4.1.3 Oil samples

#### Heidrum oil

The acid number is the important wetting parameter for chalk, and by vary the acid number it is possible to change the initial wetting of the chalk core. The biodegraded Heidrun crude oil with AN=2.80 and BN=0.74 mgKOH/g oil, was used as the base crude oil. This oil was sampled from a new well during a well-test.

#### RES40

The oil was prepared by diluting Heidrun oil with n-heptane in the ratio of 60:40 by volume. Then, the oil was centrifuged and filtered through a 0.65  $\mu\text{m}$  Millipore filter to remove any unconsolidated particles that were present in the crude oil. The acid and base numbers were AN = 1.80 and BN = 0.42 mg KOH/g oil. No precipitation of asphaltenes was observed during storage.

#### RES40-0

The oil was prepared by adding 10 wt% silica gel to RES40 crude oil in two steps to remove surface active polar components like carboxylic material. After stirring the mixture on a magnetic stirrer for 6 days, the mixture was centrifuged to separate the oil from silica gel which settled at the bottom of the centrifuge bottle. Then, the oil was filtered through a 0.65  $\mu\text{m}$  Millipore filter. The AN and BN were both zero.

#### SC Oil

The RES40 and RES40-0 oil samples were mixed by mass in the ratio of 20:80, to get synthetic crude oil. The acid and base numbers of the oil were AN=0.50 and BN=0.30 mg KOH/g oil respectively. This oil was used in all the SI tests. The densities, viscosities, acid and base numbers of all the oil samples were measured according to the procedures outlined earlier. The results are presented in Table 4.1

**Table 4.1:** Oil properties

Oil type	$\mu$ (cP)	$\rho$ (g/cm <sup>3</sup> )	AN (mg KOH/g oil)	BN (mg KOH/g oil)
Heidrun	20.47	0.886	2.80	0.74
Res40	3.17	0.809	1.80	0.42
Res40-0	2.44	0.801	0.00	0.00
SC Oil	2.53	0.800	0.50	0.30

#### 4.1.4 Brines

The different brines used as the imbibing fluids with their compositions are given in Table 4.2. The salts that were used in preparing the fluids included:  $\text{NaHCO}_3$ ,  $\text{KCl}$ ,  $\text{NaCl}$ ,  $\text{MgCl}_2 \cdot 6\text{H}_2\text{O}$ ,  $\text{CaCl}_2 \cdot 2\text{H}_2\text{O}$  and  $\text{Na}_2\text{SO}_4 \cdot \text{NaCl}$  was only added when preparing the following brines SW, SW0T, SW1/2T and VB0S. In addition,  $\text{KSCN}$  and  $\text{LiCl}$  were added when preparing SW1/2T. All salts were PA-graded and delivered by Merck. The required amount of different salts was dissolved in the deionized (DI) water. Then, the brine was stirred on a magnetic stirrer for about 2 hours to ensure homogeneous mixture. It was filtered through a  $0.22 \mu\text{m}$  Millipore filter to remove undissolved salt particles that might block pore throats during the SI tests. The stirring and filtration set-ups can be found in Appendix A.2.

**Table 4.2:** The compositions and properties of the brines.

Ions	Brines					
	VB0S (mol/l)	SW (mol/l)	SW0NaCl (mol/l)	SW4S0NaCl (mol/l)	SW0T (mol/l)	SW1/2T (mol/l)
$\text{HCO}_3^-$	0.009	0.002	0.002	0.002	0.002	0.002
$\text{Cl}^-$	1.070	0.525	0.126	0.126	0.583	0.538
$\text{SO}_4^{2-}$	0.000	0.024	0.024	0.096	0.000	0.012
$\text{SCN}^-$	0.000	0.000	0.000	0.000	0.000	0.012
$\text{Mg}^{2+}$	0.008	0.045	0.045	0.045	0.045	0.045
$\text{Ca}^{2+}$	0.029	0.013	0.013	0.013	0.013	0.013
$\text{Na}^+$	1.000	0.450	0.050	0.194	0.460	0.427
$\text{K}^+$	0.005	0.010	0.010	0.010	0.010	0.022
$\text{Li}^+$	0.000	0.000	0.000	0.000	0.000	0.012
Ionic Strength	1.112	0.657	0.257	0.473	0.643	0.645
TDS (g/l)	62.80	33.39	10.01	16.79	33.39	33.39

The VB0S was used as the reference brine. It was similar in composition to the Valhall formation water.

As the spontaneous imbibing brine, SW was synthetic seawater. This brine was termed “smart water”. The modified seawater was obtained by changing the salinity and the ionic composition of SW. “Smartness” in this context refers to the ability of seawater to alter the wetting nature of chalk to improve oil recovery.

For SW0NaCl,  $\text{NaCl}$  was not added to the composition of SW. This fluid was referred to as “Smarter Water”.

The brine SW4S0NaCl, was SW depleted in NaCl and spiked with 4 times the concentration of sulfate. The brine was regarded as “Smartest Water”.

Both SW0T and SW1/2T, were used for the chromatographic wettability tests. The SW0T was SW without  $SO_4^{2-}$ . The brine SW1/2T, was SW with  $SCN^-$  and  $Li^+$  as tracers. The concentrations of  $Ca^{2+}$  and  $Mg^{2+}$  respectively in all the brines except VB0S were kept constant.

## 4.2 Core preparation

### Initial core preparation

All cores were prepared in similar way to establish initial reservoir conditions. The procedure for core preparation was similar to the standard method described by Standnes and Austad (2000a). All cores used for the SI experiment, were drilled from the same chalk block with an oversized core bit in the same direction. They were dried at 90°C to a constant weight, and shaved to a diameter (~ 3.8 cm) using lathe. Then, they were cut with a diamond saw to the same length (~ 7.0 cm).

The next step was removal of easily dissolvable salt. The core was evacuated to remove any trapped gases, and then saturated with DI water under vacuum for 2 hours. Then, the core was placed in a Hassler core holder (see Appendix A.7) with a confining pressure of 25bar. The core was flooded at 90°C, with 250ml of DI water at the rate of 0.2 ml/min. The removal of dissolvable sulfates present in the core was confirmed by a batch test, showing no precipitation of  $BaSO_4$  when barium chloride was added to the effluent. Then, the core was dried in the oven to a constant weight at 90°C. Equation 4.1 represents the chemical reaction for a batch test.

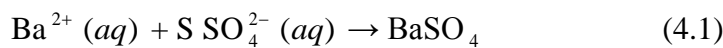

### Establishing initial water saturation ( $S_{wi}$ )

The core was saturated under vacuum with the brine (VB0S) for 2 hours. The pore volume and porosity of the core were determined by considering the weight difference after saturation (Eq.4.2 &4.3).

$$V_p = \frac{M_{sat} - M_{dry}}{\rho_{VB0S}} \quad (4.2)$$

$$\phi = \frac{V_p}{V_b} * 100 \quad (4.3)$$

$$S_{wi} = \left( \frac{M_{s_{wi}} - M_{dry}}{\rho_{VB0S}} \right) * \frac{1}{V_p} \quad (4.4)$$

Where:

$V_p$  = pore volume;  $M_{sat}$  = weight of the core at 100 % VB0S saturation;

$M_{dry}$  = dry weight of the core;  $M_{s_{wi}}$  = weight of the core at initial water saturation;  $\rho_{VB0S}$  = density of VB0S;  $V_b$  = core bulk volume; and  $\Phi$  = porosity of the core (%).

To establish  $S_{wi}$  of 10 %, the 100 % VB0S-saturated cores were drained on a porous plate, using water-saturated nitrogen gas. As the pressure in the porous plate was gradually increased to 8.5bar, the total water saturation decreased. The initial water saturation for the core was determined using Equation 4.3. Also, the description of the porous plate technique can be found in Appendix A.8.

### Establishing initial oil saturation and aging

To establish the initial oil saturation, the core was placed in a Hassler core holder. A confining pressure of 25bar was applied to ensure good sealing between the core and rubber sleeve. Also, a backpressure of 10bar kept the fluid from boiling at high temperature. The core was vacuumed for 15 min and saturated with SC oil. Then, it was flooded at 50°C with 1.5 PV of the oil in each direction, at the rate of 0.2 ml/min.

After flooding the cores with SC oil, they were wrapped with Teflon tape to prevent unrepresentative adsorption of polar components on the chalk surface. Then, the cores were put in the aging cells, surrounded with the oil. They were aged 4 weeks at 90°C. The initial oil saturation ( $S_{oi}$ ) of the cores were determined using Equation 4.7, knowing the volume of the oil in the core after aging. Table 4.3 presents the properties of all cores used in the SI tests at different temperature.

$$V_o = V_p - V_{VB0S} \quad (4.5)$$

$$V_{VB0S} = \frac{M_{s_{wi}} - M_{dry}}{\rho_{VB0S}} \quad (4.6)$$

$$S_{oi} = \frac{V_o}{V_p} \quad (4.7)$$

Where:

$S_{oi}$  = initial oil saturation;  $V_{VB0S}$  = volume of VB0S in the core before aging;

$V_o$  = volume of oil in the core after aging.

**Table 4.3: Core Properties**

Core ID	L (cm)	D (cm)	$V_b$ (cm <sup>3</sup> )	$V_p$ (cm <sup>3</sup> )	$\Phi$ (%)	$S_{wi}$ (%)	$S_{oi}$ (%)	Comments
SK#1	7.02	3.80	79.61	37.91	48	10	90	SI at 90 °C
SK#2	7.00	3.80	79.39	37.08	47	10	90	-
SK#3	7.02	3.79	79.20	36.27	46	11	89	SI at 90 °C
SK#4	7.00	3.79	78.97	38.34	49	9	-	-
SK#5	7.02	3.80	79.61	37.13	47	9	91	SI at 90 °C
SK#6	7.02	3.80	79.61	36.74	46	10	90	SI at 90 °C
SK#7	7.01	3.81	79.92	36.98	46	11	89	SI at 70 °C
SK#8	7.00	3.81	79.81	35.37	44	11	89	SI at 70 °C
SK#9	7.01	3.81	79.92	35.53	44	10	90	SI at 70 °C

### 4.3 Spontaneous imbibition tests

#### The SI at 90°C (Steel cell)

Four different SI tests were performed at 90°C:

- The SI with VB0S - VB0S and the reference core represented a system with no chemical wettability alteration
- The SI with SW - the brine which has been defined as a “Smart Water”
- The SI with SW0NaCl - the brine confirmed to be “Smarter Water”
- The SI with SW4S0NaCl - the brine with increased concentration of sulfate and was termed the “Smartest Water”.

In these tests, four steel imbibition cells were used. A back pressure of 10bar was applied to prevent the fluids from boiling at high temperature. The aged core was immersed in the imbibing fluid in the sealed steel cell, with four marbles in the bottom of the cell. This ensured good contact between the core and the fluid. Then, the produced oil was collected in a graduated burette and measured at different time intervals for 37 days. The oil recovery factor (% OOIP), as a function of time (days) was determined. Figure 4.1 shows the schematic diagram for the SI tests 90°C.

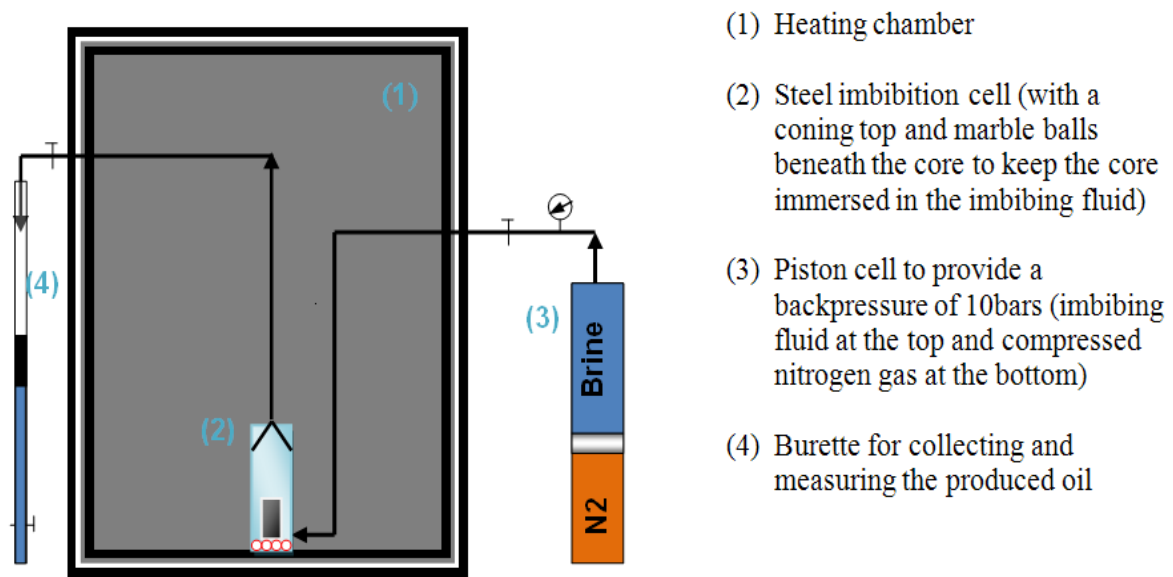

**Figure 4.1:** The SI test unit at higher temperature (Zhang, 2006)

### The SI at 70°C (Amott glass cell)

Three different SI tests were performed at the lower temperature. The spontaneous imbibing brines used were SW, SW0NaCl and SW4S0NaCl. For these tests, standard Amott glass cells were used. The aged core was immersed in the imbibing fluid in the glass cell, with four marbles in the bottom of the cell. Then, the produced oil was collected in a graduated burette and measured at different time intervals for 43 days. The oil recovery factor (% OOIP), as a function of time (days) was determined. Figure 4.1 shows the schematic diagram for the SI test.

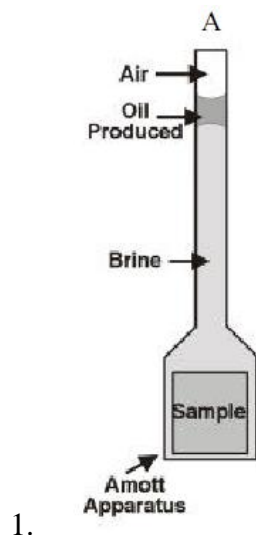

**Figure 4.1:** The SI test unit at 70°C using Amott glass cell (Aksulu, 2010)

## 4.4 Chromatographic wettability test.

The chromatographic wettability test was used to determine the water-wet surface area of the chalk core after spontaneous imbibition with the imbibing brine. The test is based on the chromatographic separation between non-adsorbing tracer,  $\text{SCN}^-$ , and sulfate ion,  $\text{SO}_4^{2-}$ .

The core was placed in a Hassler core holder and a confining pressure of 25bar was applied. The core was flooded at constant back pressure of 10 bars with at least 2.0 PV of SW0T brine (without  $\text{SO}_4^{2-}$  and tracers) at the rate of 0.20ml/min. This was followed by another 2.0 PV at the rate of 0.40 ml/min, to establish residual oil saturation ( $S_{or}$ ). The rate was again reduced to 0.20 ml/min and the effluent was checked for  $\text{SO}_4^{2-}$ . After at least 1.0 PV was injected and no  $\text{SO}_4^{2-}$  was observed in the effluent, the injection fluid was changed to SW1/2T brine (containing  $\text{SO}_4^{2-}$ , and the tracers  $\text{SCN}^-$  and  $\text{Li}^+$ ). The effluent was collected in fractions of 1-4 ml using a fraction collector (see Figure 4.2). Totally, more than 2.0 PV of SW1/2T was injected.

Each fraction was diluted 200 times with DI water, using Gilson GX-271 Liquid Handler. It was filtrated and transferred to 1.5ml HPLC glasses. The samples were analysed for concentrations of  $\text{SO}_4^{2-}$  and tracer,  $\text{SCN}^-$ , using Dionex ICS-3000 Ion Chromatograph. The concentration of each ion relative to the initial concentration was plotted against the injected pore volume. The area between the tracer and the sulfate curves is directly proportional to the water-wet surface area inside the core. This is based on the fact that the chromatographic separation takes place only at the water-wet sites. The area ratio between the tracer and sulfate curves of the sample,  $A_{wet}$ , and a reference cleaned water-wet core,  $A_{ref}$ . The wettability index (WI) is a measure of the water-wet surface fraction of the core sample.

$$WI = \frac{A_{wet}}{A_{ref}} \quad (4.3)$$

Where: WI = 0 is completely oil-wet, WI = 0.5 is neutral wettability, and WI = 1, is completely water-wet.

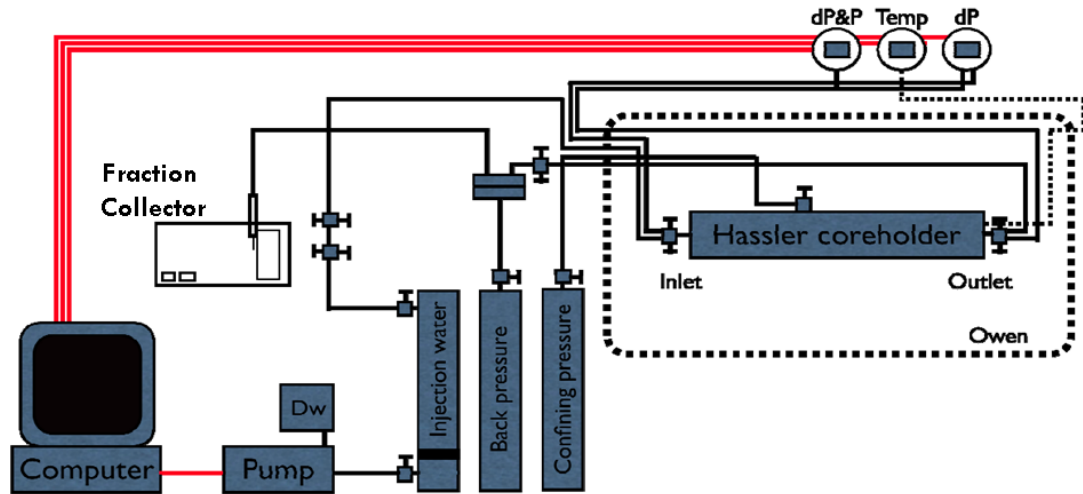

**Figure 4.2:** Core flooding set-up for the wettability test.



## 5 Results and Discussion

In this section, the results of the SI and chromatographic wettability tests are presented and discussed.

### 5.1 Spontaneous imbibition at 90°C.

Four cores with the same initial conditions were used. The 10% initial water saturation was established using porous plate technique. The cores were saturated, flooded and aged with SC oil (with AN= 0.5mgKOH/g oil). The cores were imbibed in steel cells with different imbibing brines (VB0S, SW, SW0NaCl, and SW4S0NaCl), at 90°C. The results of the SI tests are presented in Figure 5.1.

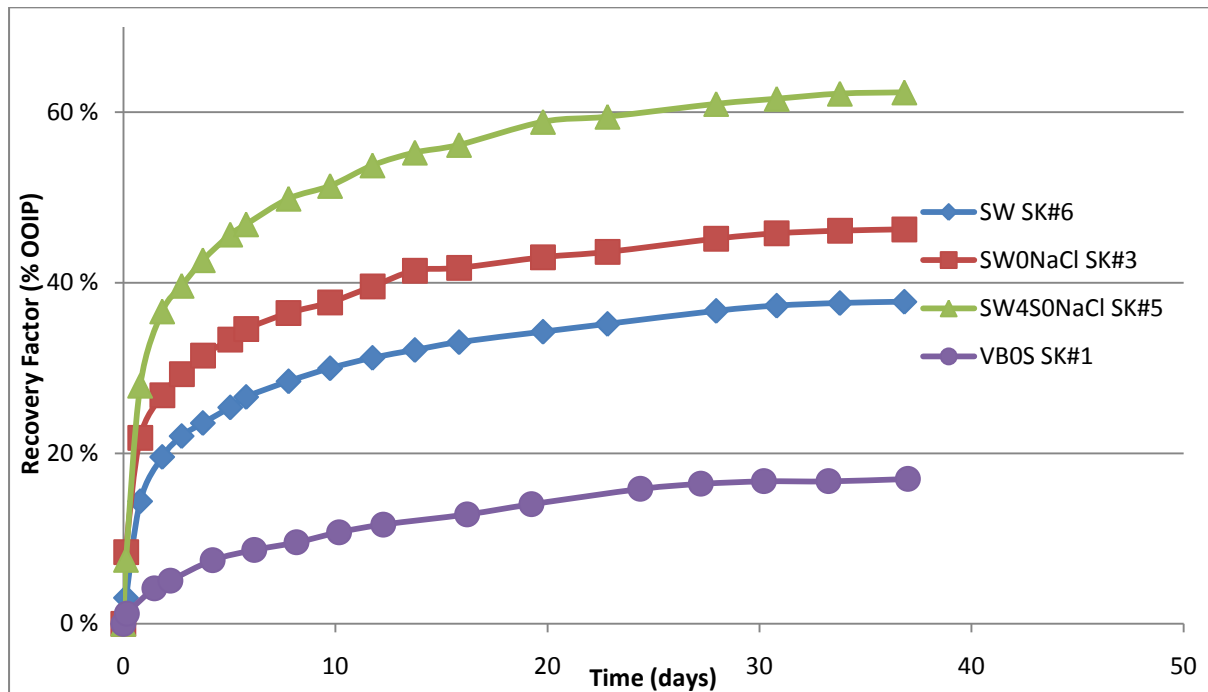

**Figure 5.1:** The effects of modifying the salinity and the ionic compositions on oil recovery from oil-saturated chalk cores with different imbibing brines (VB0S, SW, SW0NaCl and SW4S0NaCl). Conditions:  $T_{im} = 90^{\circ}\text{C}$ ,  $S_{wi} \approx 10\%$ .

The SI with formation brine (VB0S) gave a recovery plateau of 17 % after 30 days. Using VB0S as the imbibing fluid, no chemical wettability alteration was expected to take place and the result represented the initial wetting condition of the core. Close to 7 % of the recovery could be due to thermal expansion. The result indicated that the core behaved slightly water-wet.

The second core was imbibed with SW. The recovery plateau of 38 % was reached after 34 days. The effect of using “Smart Water” can be easily seen. A 21 % increase in oil recovery compared to the brine (VBOS) with no ability to change the wetting condition, was observed. The third core was imbibed with SW0NaCl. The ultimate recovery from this core was 46% after 31 days. By using the brine with reduced concentrations of non-active ions ( $\text{Na}^+$  and  $\text{Cl}^-$ ), an additional 29 % of OOIP was recovered compared to the formation brine. The fourth core was imbibed with SW4S0NaCl. This imbibing brine was regarded as the “Smartest Water”. The concentration of sulfate in SW was increased 4 times to obtain the brine. The SI with the brine gave a recovery plateau of 62 % after 31 days. This was the oil recovery normally obtained for a completely water-wet core. In comparison to VBOS, a 45 % increase in the recovery was obtained. The result showed that the rate of imbibition was greatly improved due to the catalytic effect of sulfate and reduced concentration of the non-active ions.

The performance of different imbibing brines showed that oil recovery could be improved by modifying the salinity and the ionic composition of SW. Both  $\text{Na}^+$  and  $\text{Cl}^-$  ions were regarded as the non-active ions in the SI process. Reducing the concentrations of these ions, gave the active ions ( $\text{SO}_4^{2-}$  and  $\text{Ca}^{2+}$ ) easier access to the chalk surface. This equally reduced the salinity of seawater.

The sulfate ion,  $\text{SO}_4^{2-}$ , present in seawater acted as a catalyst in the wettability alteration mechanism. As  $\text{SO}_4^{2-}$  adsorbed onto the chalk surface, there was co-adsorption of  $\text{Ca}^{2+}$  to release the adsorbed carboxylic material. This reduced the concentration of sulfate at the imbibition front. Thus, increasing the concentration of sulfate, increased both the imbibition rate and the ultimate recovery.

## 5.2 Spontaneous imbibition at 70°C

Three cores with the same initial conditions were used. The 10% initial water saturation was established using porous plate technique. The cores were saturated, flooded and aged with SC oil (with AN= 0.5mgKOH/g oil). The cores were imbibed in standard Amott glasses with different imbibing brines (SW, SW0NaCl, and SW4S0NaCl) at 90°C. The results of the SI tests are presented in Figure 5.2.

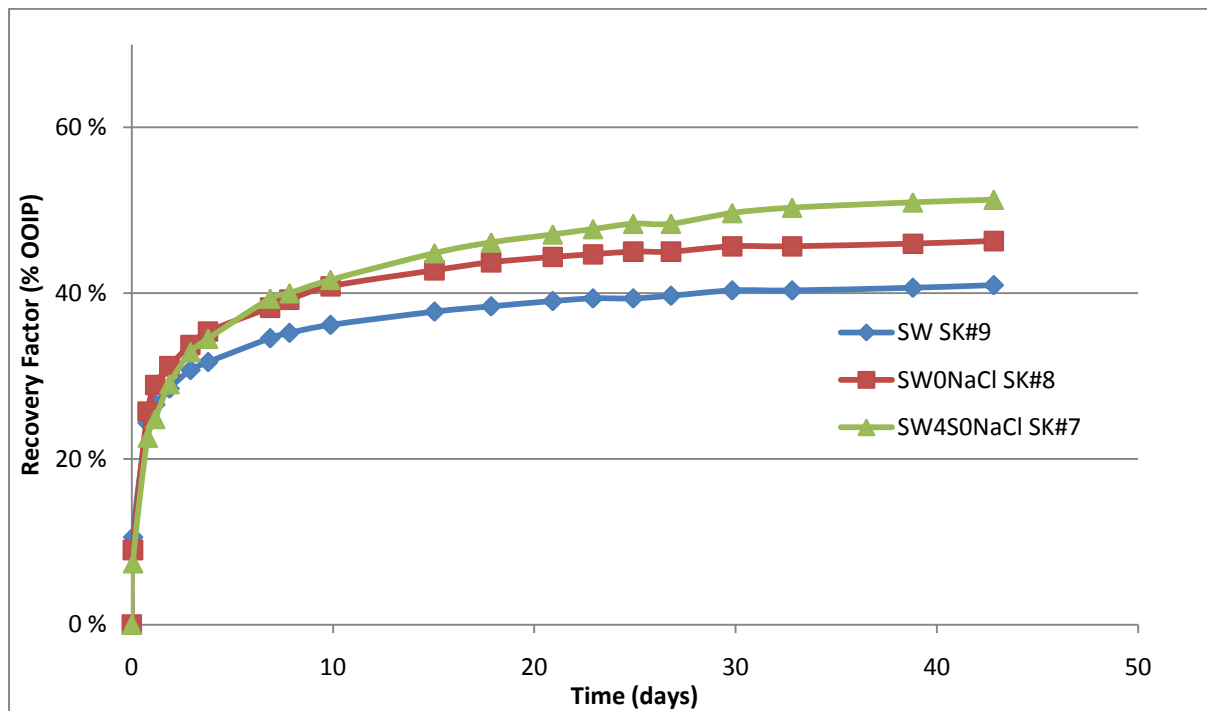

**Figure 5.2:** The effects of modifying the salinity and the ionic compositions on oil recovery from oil-saturated chalk cores with different imbibing brines (SW, SW0NaCl and SW4S0NaCl). Conditions:  $T_{im} = 70^{\circ}\text{C}$ ,  $S_{wi} \approx 10\%$ .

The first core was imbibed with SW and a recovery plateau of 41 % was reached after 39 days. This showed that SW could be used as a wettability modifier for a slightly water-wet chalk core at temperature close to 70°C.

The second core was imbibed with SW0NaCl. The SI with the brine gave a recovery plateau of 46 % after 39 days. The increment was to the modification in the salinity and the ionic composition of seawater.

The spontaneous imbibing brine for the third core was SW4S0NaCl. The ultimate recovery from the core was 51 % of OOIP. The brine was confirmed to be the “smartest water”, as both imbibition rate and oil recovery were improved.

From the experimental results, the oil recovery increased in the following order; SW < SW0NaCl < SW4S0NaCl. Although a reference system was not used, a similar trend was observed as in the SI tests at 90°C. We expected the lowest oil recovery with the formation brine (VB0S).

The imbibition rate at 70°C was lower than at 90°C. Strand et al. (2006) showed that both the adsorption of  $SO_4^{2-}$  and the co-adsorption of  $Ca^{2+}$  onto the chalk surface increased with temperature.

The results of the SI tests demonstrated that oil recovery could be improved by reducing the concentrations of the non-active ions present in seawater. Increasing the concentration of sulfate, which has the catalytic effect in the wettability alteration process, increased both the imbibition rate and the ultimate recovery. For a slightly water-wet system, “Smart Water” was able to improve the oil recovery at temperatures down to 70°C.

### 5.3 Chromatographic wettability test analyses

The results of the chromatographic wettability tests on the chalk cores are presented in Figures 5.3, 5.4, and 5.5.

The cores had been spontaneously imbibed at 90 and 70°C and flooded to  $S_{or}$  before testing.

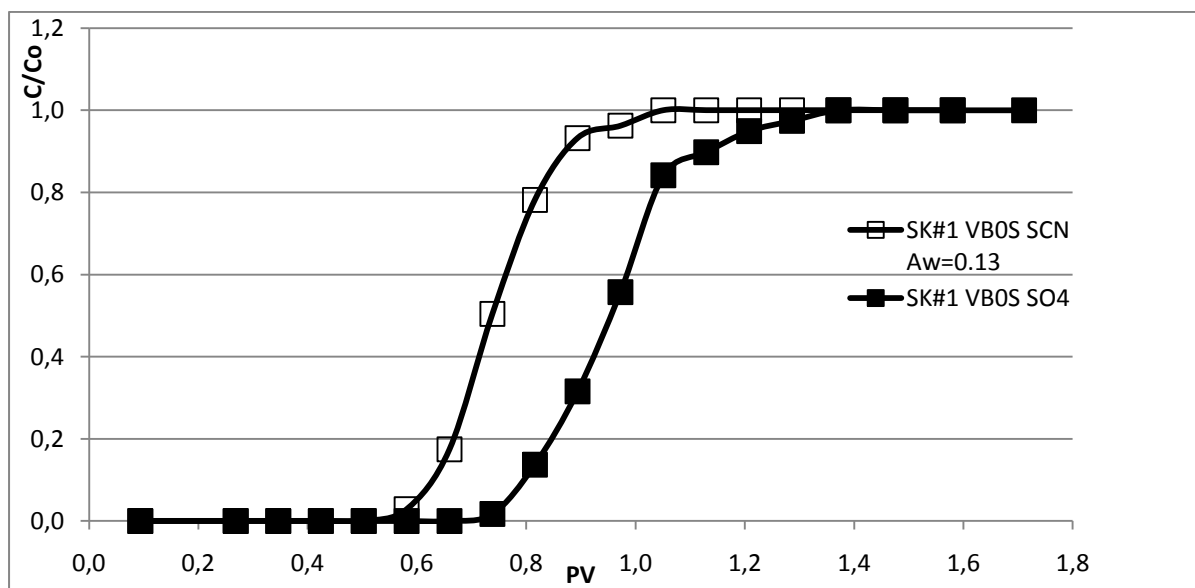

**Figure 5.3:** Wettability test of core SK#1 with effluent profiles of  $SCN^-$  and  $SO_4^{2-}$ . The core was spontaneously imbibed with VB0S at 90°C and flooded to  $S_{or}$  before testing.

The water-wet surface area ( $A_w$ ) of the chalk core SK#1 imbibed with VB0S at 90°C was 0.13, representing the initial wetting condition of all the Stevns Klint cores. No chemical wettability alteration should take place when the core is imbibed with the formation brine.

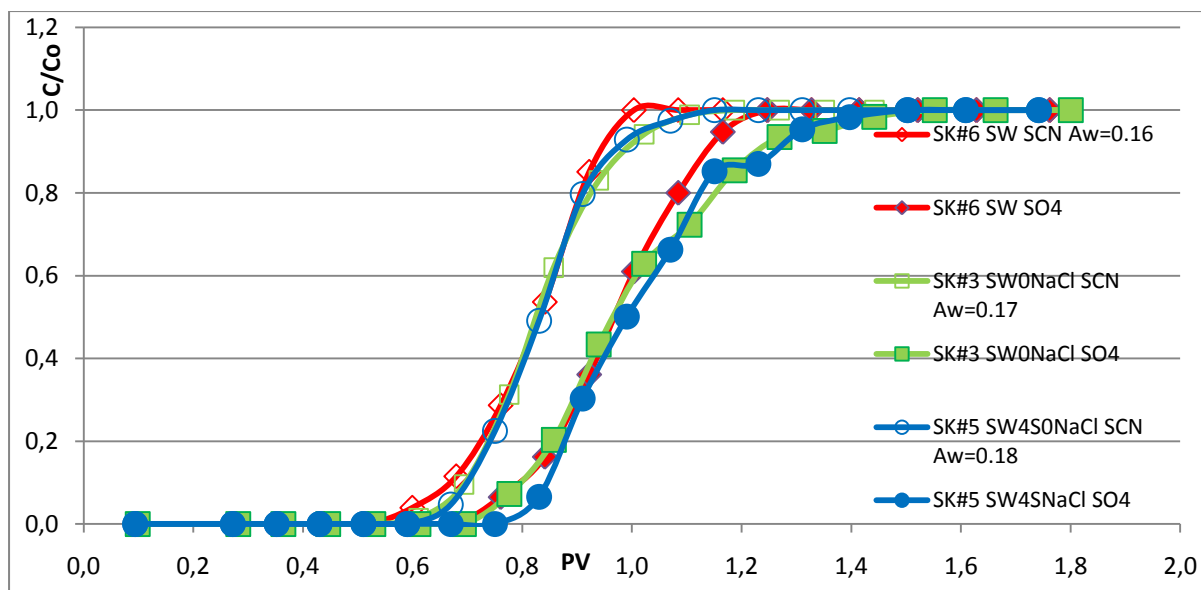

**Figure 5.4:** Wettability test of cores (SK#6, SK#3, and SK#5) with effluent profiles of  $\text{SCN}^-$  and  $\text{SO}_4^{2-}$ . The cores were spontaneously imbibed with (SW, SW0NaCl, and SW4S0NaCl) respectively at  $90^\circ\text{C}$ , and flooded to  $S_{or}$  before testing

The core SK#6 imbibed with SW had a water-wet surface area of 0.16. The effect of using seawater was seen. The  $A_w$  of the core increased because the wettability alteration process had taken place.

The  $A_w$  of the core SK#3 spontaneously imbibed with SW0NaCl was 0.17. The increment in the area was due to the modification in the salinity and the ionic composition of the seawater. The  $A_w$  of the core SK#5 imbibed with SW4S0NaCl was 0.17. The water-wetness of the core was improved by increasing the “smartness” of seawater.

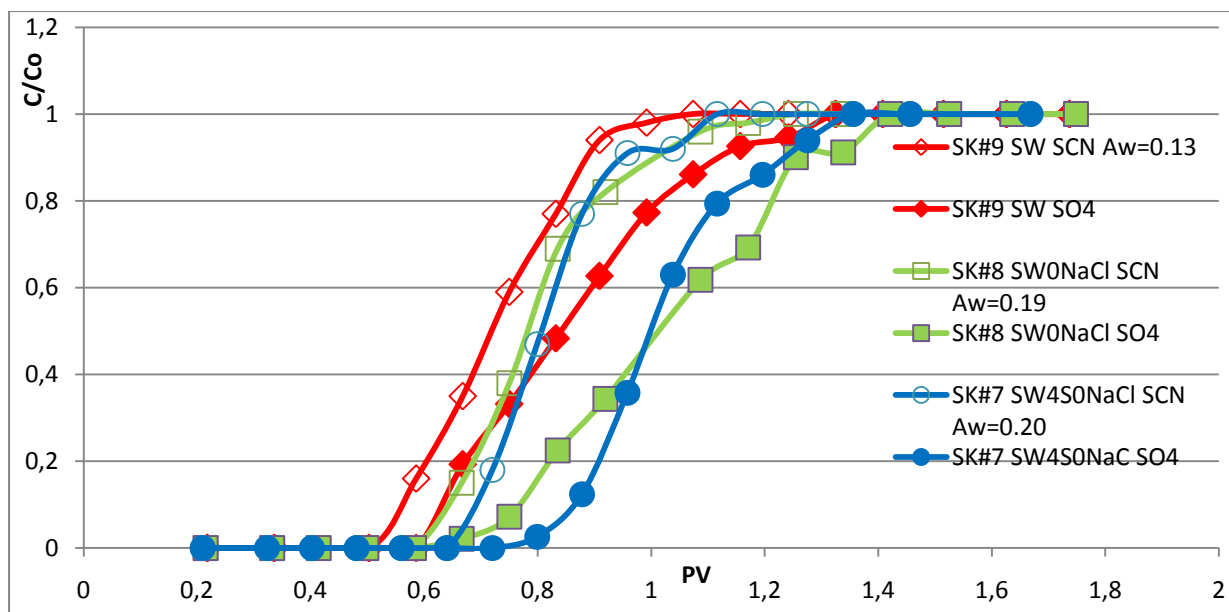

**Figure 5.5:** Wettability test of cores (SK#6, SK#3, and SK#5) with effluent profiles of  $\text{SCN}^-$  and  $\text{SO}_4^{2-}$ . The cores were spontaneously imbibed with brines (SW, SW0NaCl, and SW4S0NaCl) respectively at  $70^\circ\text{C}$ , and flooded to  $S_{or}$  before testing

The  $A_w$  of the core SK#9 spontaneously imbibed with SW at  $70^\circ\text{C}$  was 0.13.

The core SK#8 imbibed with SW0NaCl was 0.19. The water-wetness of the core was improved by modifying the salinity and the ionic composition of seawater.

The water-wet surface area of the core SK#7 imbibed with SW4S0NaCl was 0.20. The water-wetness of the core was increased by improving the “smartness” of seawater.

A similar trend was observed both at  $90$  and  $70^\circ\text{C}$ , though seawater was less effective at  $70^\circ\text{C}$ . The wettability tests confirmed the chemical wettability alteration process. The results showed the effect of modifying the salinity and the ionic composition of seawater. The chalk core became more water-wet with increasing “smartness” of the imbibing fluid.

## 6 Conclusions

The main objective of the project was to modify the salinity and the ionic composition of seawater to improve the ultimate oil recovery in the slightly water wet chalk cores. The conclusion can be briefly summarized as:

- The imbibition rate and ultimate recovery were increased by reducing the concentration of non-active ions like  $\text{Na}^+$  and  $\text{Cl}^-$  in seawater.
- A decrease in the concentrations of non-active ions,  $\text{Na}^+$  and  $\text{Cl}^-$  reduced the salinity and improved the reactivity of the surface active ions,  $\text{SO}_4^{2-}$  and  $\text{Ca}^{2+}$ . The ions will have easier access to the chalk surface.
- Increasing the sulphate concentration which has a catalytic effect on the wettability alteration, improved both the imbibition rate and ultimate recovery.
- For slightly water-wet systems, improved oil recovery with “Smart Water” was observed both at 90 and 70°C.
- The chromatographic wettability tests confirmed the chemical wettability alteration process. The results showed that the water-wetness of the chalk core increased with increasing “smartness” of seawater.

## References

1. Aksulu, H., 2010. “*Effect of Core Cleaning Solvents on Wettability Restoration and Oil Recovery by Spontaneous Imbibition in Surface Reactive, Low Permeable Limestone Reservoir Core.*” M.Sc. Thesis University of Stavanger, Norway.
2. Al-Hadhrami, H.S. and Blunt, M. J., 2000. “*Thermally Induced Wettability Alteration to Improve Oil Recovery in Fractured Reservoir.*” Paper SPE 59289 presented at SPE/DOE Improved Oil Recovery Symposium, Tulsa , OK, USA, April 3-5
3. Amott, E., 1959. “*Observations Relating to the Wettability of Porous Rock.*” Petroleum Transactions, AIME, pp. 156-162.
4. Andersen, M.A., 1995. “*Petroleum Research in North Sea Chalk.*” Amoco Norway Oil Company and RF –Rogaland Research. ISBN 82-7220-725-7.
5. Anderson, W.G., 1986a. “*Wettability Literature Survey - Part 1: Rock /Brine/Oil Interactions and the Effects of Core Handling on Wettability.*” Journal of Petroleum Technology, October, 1125-1144.
6. Anderson, W.G., 1986b. “*Wettability Literature Survey - Part 1: Rock/Oil/Brine Interactions and the Effects of Core Handling on Wettability.*” Journal of Petroleum Technology, October, pp. 1125-1144
7. Anderson, W.G., 1986b. “*Wettability Literature Survey - Part 2: Wettability Measurements.*” Journal of Petroleum Technology, November, pp.1246-1262.
8. Anderson, W.G., 1987. “*Wettability Literature Survey-Part 6: The Effect of Wettability on Waterflooding.*” Journal of Petroleum Technology, December, pp.1605-1622.
9. ASTM, I, 1988. “*ASTM 2896-88 Standard test method for base number of petroleum products by potentiometric perchloric acid titration, in Annual Book of ASTM Standards.*” Philadelphia.
10. ASTM, I, 1988. “*ASTM 664-89 Standard test method for acid number of petroleum products by potentiometric titration, in Annual Book of ASTM Standards.*” Philadelphia.
11. Austad, T.; Matre, B.; Milter, J.; Sævareid, A.; and Øyno, L. , 1998. “*Chemical Flooding of Oil Reservoir 8. Spontaneous Oil Expulsion from Oil-and Water-wet Low Permeable Chalk Material by Imbibition of Aqueous Surfactant Solutions.*” Colloids and Surfaces A: Physiochemical and Engineering Aspects, 137, 117-129.
12. Austad, T. and Milter, J., 1997. “*Spontaneous Imbibition of Water into Low Permeable Chalk at Different Wettabilities Using Surfactants.*” Paper SPE 37236 presented at the International Symposium on Oilfield Chemistry held in Houston,TX, USA, February 18-21.
13. Austad, T.; Strand, S.; Høgnesen, E. J. and Zhang, P., 2005. “*Seawater as IOR Fluid in Fractured Chalk.*” Paper SPE 93000 presented at the SPE International Symposium on Oilfield Chemistry held in Houston, Texas, USA, 2-4 February.
14. Austad, T.; Strand, S.; Madland, M. V.; Puntervold, T.and Korsnes, R.I., 2007. “*Seawater in Chalk: An EOR and Compaction Fluid.*” Paper IPTC 11370 presented at the International Petroleum Technology Conference, Dubai U.A.E. December 4-6.



15. Baviere, M. 1991. *Preface*. In. Critical Reports on Applied Chemistry, Vol. 33. Basic Concepts in Enhanced Oil Recovery Processes. Ed. Baviere, M. Published for SCI by Elsevier Applied Science, London and New York, pp. V-VIII.
16. Buckley, J. S. and Liu, Y., 1998. "*Some Mechanisms of Crude Oil / Brine/solid Interactions*." Journal of Petroleum Science and Engineering, 20, pp. 155-160.
17. Buckley, J.S., 1996. "*Mechanisms and Consequences of Wettability Alteration by Crude Oils*." PhD Thesis. Department of Petroleum Engineering, Heriot-Watt University, Edinburgh, UK.
18. Buckley, J. S., 2001. "*Effective Wettability of Minerals Exposed to Crude Oil*." Current Opinion in Colloid & Interface Science, Volume 6, Issue 3, June, pp.191-196.
19. Castor, T. P.; Somerton, W. H. and Kelly, J. F., 1981. "*Recovery Mechanisms of Alkaline Flooding*." In: Surface Phenomenon in Enhanced Oil Recovery. Ed. Shah, D. O. Plenum.
20. Chilingar, G.V. and Yen, T.F., 1983. "*Some Notes on Wettability and Relative Permeability of Carbonate Rocks*." II. Energy and Sources, 7: 67-75.
21. Cole, F.W., 1969. "*Reservoir engineering manual*." Gulf Publishing Company, Houston, Texas. Printed in USA . Library of Congress Catalog Card number 60-16853.
22. Cossé, R., 1993. "*Basics of Reservoir Engineering. Oil and Gas Field Development Techniques*." Editions Technip, Paris. ISBN 2-7108-0630-4. Printed in France by Imprimerie Nouvelle, 45800 Saint-Jean-de-Braye.
23. Craig, F.F., 1971. "*The Reservoir Engineering Aspects of Waterflooding*." Monograph Series, SPE, Richardson, TX, Vol. 3, 12-44.
24. Cuiec, L. 1984. "*Rock/Crude-oil interactions and Wettability: An Attempt to Understand the Interaction*." Paper SPE 13211 presented at the SPE 59<sup>th</sup> Annual Technical Conference and Exhibition in Houston, TX, USA, September 16-19.
25. Cuiec, L.E., 1991. "*Evaluation of Reservoir Wettability and its Effect on Oil Recovery*." In: Surfactant Science Series, Vol. 36. Interfacial Phenomena in Petroleum Recovery. Ed. Morrow, N. R., Marcel Dekker, Inc., New York and Basel.
26. Donaldson, E.C.; Thomas, R.D. and Lorenz, P.B., 1969. "*Wettability Determination and Its Effect on Recovery Efficiency*." SPE Journal, March, 13-20.
27. Fan, T. and J.S. Buckley, 2007. "*Acid Number Measurements Revisited*". SPE Journal, **12**(4): p. pp. 496-500.
28. Farouq-Ali, S. M. and Stahl, C. D., 1970. "*Increased Oil Recovery by Improved Waterflooding*." Earth and Mineral Sciences, Vol. 39, No. 4, January, pp. 25-28.
29. Fathi, S.J., Austad, T., and Strand, S., 2010. "*Smart Water*" as a Wettability Modifier in Chalk: The Effect of Salinity and Ionic Composition." Energy and Fuels, Vol. 24, 2514-2519 .
30. Flügel, E., 2004. "*Microfacies of Carbonate Rocks: Analysis, Interpretation and Application*." Springer, Berlin, 2004.
31. Gluyas, J., and Swarbrick, R., 2004. "*Petroleum Geoscience*." Blackwell Science Ltd a Blackwell Publishing company. Printed in U.K. ISBN 0-632-03767-9.
32. Green, D. W. and Willhite, G. P., 1998. "*Enhanced Oil Recovery*." Society of Petroleum Engineer, Vol. 6, Richardson, Texas.

33. Hirasaki, G. and Zhang, D. L., 2003. “*Surface Chemistry of Oil Recovery from Fractured, Oil-Wet, Carbonate Formations.*” Paper SPE presented at the SPE International Symposium on Oilfield Chemistry, Houston, TX, February 5-8.
34. Hirasaki, G. and Zhang, D. L., 2004. “*Surface Chemistry of Oil Recovery from Fractured, Oil-Wet, Carbonate Formations.*” SPE Journal, 9(2): 151-162.
35. Hjemeland, O.S., and Larrondo, L.E. 1986. “*Experimental Investigation of the Effects of Temperature, Pressure and Crude Oil Composition on Interfacial Properties.*” SPE Reservoir Eng. July, pp. 261-264.
36. Høgenesen, E. J., Strand, S., and Austad, T., 2005. “*Waterflooding of Preferential Oil-wet Carbonates: Oil Recovery Related to Reservoir Temperature and Brine Composition.*” Paper SPE 94166 Presented at the 14th Europec Biennial Conference held in Madrid, Spain, 13-16 June.
37. Hornf, V. and Morrow, N. R., 1987. “*Gravity Effects in the Displacement of Oil by Surfactant Solutions.*” SPE Reservoir Engineering, November, pp. 627-633.
38. Hunter, R. J., 1996. “*Introduction to Modern Colloid Science.*” Oxford University Press Inc., New York.
39. Kaminsky, R. and Radke, C. J., 1998. “*Water Films, Asphaltenes, and Wettability Alteration.*” Paper SPE 39087 presented at the SPE/DOE Improved Oil Recovery Symposium held in Tulsa, OK, USA, April 19-22
40. Kovscek, A. R.; Wong, H., and Radke, C. J., 1993. “*A Pore-Level Scenario for the Development of Mixed Wettability in Oil Reservoirs*” AICHE Journal, 39(6), 1072-1085.
41. Lake, L. W., 1989. “*Enhanced Oil Recovery,*” Prentice Hall, New Jersey.
42. Lazar, I., Petrisor, I. G., and Yen, T. F., 2007. “*Microbial Enhanced Oil Recovery (MEOR),*” Journal of Petroleum Science and Technology, Vol.25, pp 1353-1366.
43. Legens, C.; Toulhoat, H.; Cuiec, L.; Villieras, F. and Palermo, T., 1998. “*Wettability Change Related to the Adsorption of Organic Acids on Calcite: Experimental and Ab Initio Computational Studies.*” Paper SPE 49319 presented at the Annual Technical Conference and Exhibition, New Orleans, Louisiana, 27-30 September.
44. Liu, Y. and Buckley, J.S. 1997. “*Evolution of Wetting Alteration by Adsorption from Crude Oil.*” SPE Formation Evaluation, March, pp 5-11.
45. Ma, S. M., Morrow, N. R., Zhang, X., and Zhou, X., 1999. “*Characterization of Wettability from Spontaneous Imbibition Measurements.*” Journal of Canadian Petroleum Technology, Vol.38, pp 94-47.
46. Manrique, E. J.; Muci, V. E. and Gurfinkel, M. E., 2007. “*EOR Field Experiences in Carbonate Reservoirs in the United States.*” SPE Reservoir Evaluation & Engineering, paper SPE100063 presented at the 2006 SPE/DOE Symposium on Improve Oil Recovery Oil Recovery, Tulsa. 22 – 26th April.
47. Marle, C. M., 1991. “*Oil Entrapment and mobilization,*” In: Critical Reports on Applied Chemistry Volume 33. Basic Concepts in Enhanced Oil Recovery Processes. (Ed. Baviere, M) Published for SCI by Elsevier Science, London and New York, pp. 3-39.
48. Menezes, J. L.; Yan, J., and Sharma, M. M., 1989. “*The Mechanism of Wettability Alteration due to Surfactants in Oil-based muds.*” Paper SPE 18460 presented at the

- SPE International Symposium on Oilfield Chemistry held in Houston, TX, USA, February 8-10.
49. Milner, J., and Austad, T., 1996. "Chemical Flooding of Oil Reservoirs 7. Oil Expulsion by Spontaneous Imbibition of Brine with and without Surfactant in Mixed-wet, Low Permeability Chalk Material." Colloids and Surfaces A: Physicochemical and Engineering Aspects, Volume 117, Issues 1-2, October 15, pp. 109-115.
  50. Morrow, N. R., and Mason, C., 2001. "Recovery of Oil by Spontaneous Imbibition." Current opinion in Colloid and Interface Science, 6: 321-337.
  51. Morrow, N.R., 1997. "Interplay of Capillary, Viscous and Buoyancy Forces in the Mobilization of Residual Oil." Journal Canadian Petroleum Technology, September, pp.35-46.
  52. Murty, C.R.K.; Al-Saleh, N., and Dakessian, B. A., 1987. "Forty-Seven Years' Gas Injection in a Preferentially Oil-wet, Low-dip Reservoir." Journal Petroleum Technology, March, pp. 363-368.
  53. NPD, Norwegian Petroleum Directorate, 1993. "Improved Oil Recovery – Norwegian Continental Shelf."
  54. Pierre, A.; Lamarche, J. M.; Mercier, R.; Foissy, A. and Persello, J., 1990. "Calcium as Potential Determining Ion in Aqueous Calcite Suspensions." Journal Dispersion Science and Technology, 11, No.6 611-635.
  55. Plateau, T.A.F., 1963-66. "Experimental Research on the Figures of Equilibrium of a Liquid Mass Withdrawn from the Action of Gravity." Annual Reports, Smith Inst.
  56. Puntervold, T., 2008. "Waterflooding of Carbonate Reservoirs: EOR by Wettability Alteration," PhD Thesis, University of Stavanger, Norway.
  57. Raza, S.H., Treiber, L.E., and Archer, D.L., 1968. "Wettability of Reservoir Rocks and Its Evaluation." April, No.4, 2-7.
  58. Roehl, P. O. and Choquette, P. W., 1985. "Carbonate Petroleum Reservoirs." Springer-Verlag, New York.
  59. Røgen, B. and Fabricius, I. L., 2002. "Influence of Clay and Silica on Permeability and Capillary Entry Pressure of Chalk Reservoirs in the North Sea." Petroleum Geoscience, Vol.8, 287-293.
  60. Rønningsen, H. P., 1991. "The Chemistry of Asphaltenes and Their Significance in Crude Oil Exploration and Production." Lecture for the Degree of Doctor of Philosophy, December 13, Oslo, Norway.
  61. Salathiel, R.A., 1973. "Oil Recovery by Surface Film Drainage in Mixed-Wettability Rocks." Journal of Petroleum Technology, October, pp.1216-1224.
  62. Schembre, J., Akin, S., and Kovscek, A.R., 1998. "Spontaneous Imbibition in Low Permeability Media." SUPRI 114 Report, Contract No. DE-FG22-96BC14994, Tulsa, OK.
  63. Schembre, J., Akin, S., and Kovscek, A. R., 1998. "Spontaneous Imbibition in Low Permeability Media," SUPRI TR 114 Report, Performed Under Contract No. DE-FG22-96BC14994, prepared for U.S. Department of Energy, Tulsa, December.
  64. Seethapalli, A., Adibhatla, B., and Mohanty, K.K., 2004. "Physicochemical Interactions During Surfactant Flooding of Fractured Carbonate Reservoirs." SPE Journal (December), pp. 411-418.

65. Shariatpanahi, S. F., Strand, S., and Austad, T., 2010. "Evaluation of Enhanced Oil Recovery (EOR) by Wettability Alteration in a Low –Permeable Fractured Limestone Oil Reservoir," Energy Fuels, 24(11), pp. 5997-6008.
66. Shariatpanahi, S. F., Strand, S., and Austad, T., 2010. "Evaluation of Enhanced Oil Recovery (EOR) by Wettability Alteration in a Low –Permeable Fractured Limestone Oil Reservoir," Energy Fuels, 24(11), pp. 5997-6008.
67. Skæveland S. M., and Kleppe, J., 1992. "Recent Advances in Improved Oil Recovery Methods for North Sea Sandstone Reservoirs." Norwegian Petroleum Directorate, Stavanger, ISBN 82-7257-340-7 YA 753.
68. Skauge, A.; Standal, S.; Boe, S. O.; Skauge, T. and Blokhus, A. M., 1999. "Effects of Organic Acids and Bases, and Oil Composition on Wettability." Paper SPE 56673 presented at the SPE Annual Technical Conference and Exhibition held in Houston, TX, USA, October 3-6.
69. Speight, J. G., 1999. "The Chemistry and Technology of Petroleum." 3<sup>rd</sup> edition revised and expanded. Marcel Dekker, Inc. New York and Basel.
70. Spinler, E. A., Zornes, D.R. , Tobola, D. P., Moradi-Araghi, A., 2000. "Enhanced Oil Recovery Using a Low Concentration of Surfactant to Improve Spontaneous and Forced Imbibition in Chalk." SPE 59290, presented at the 2000 SPE/DOE Improve Oil Recovery Symposium, Tulsa, OK, April 3-5
71. Standnes, D. C. and Austad, T., 2000b. "Wettability Alteration in Chalk, 2. Mechanisms for Wettability Alteration from Oil-wet to Water- wet Using Surfactants." Journal of Petroleum Science and Engineering 28, pp. 123-143.
72. Standnes, D.C. and Austad T., 2003. "Wettability Alteration in Carbonates. Interaction between Cationic Surfactant and Carboxylates as a Key Factor in Wettability Alteration from Oil-wet to Water-wet Conditions." Colloids and Surfaces A: Physicochem. Eng. Aspects 216, pp. 243-259.
73. Standnes, D.C. and Austad, T., 2000a. "Wettability Alteration in Chalk 1: Preparation of Core Material and Oil Properties." Journal of Petroleum Science and Engineering 28, pp. 111-121.
74. Strand, S., 2005. "Wettability Alteration in Chalk: A Study of Surface Chemistry," PhD Thesis, University of Stavanger, Norway.
75. Strand, S.; Austad, T.; Puntervold, T.; Høgnesen, E. J.; Olsen, M. and Barstad, S. M. F., 2008. "'Smart Water' for Oil Recovery from fractured Limestone – A preliminary Study," Energy Fuels, 22, pp. 3126 – 3133.
76. Strand, S.; Høgnesen, E.J., and Austad, T., 2006a. "Wettability Alteration of Carbonates- Effects of Potential Determining Ions ( $Ca^{2+}$  and  $SO_4^{2-}$ ) and Temperature." Colloids and Surfaces A: Physiochem. Eng. Aspects, 275: 1-10.
77. Strand, S., Standes, D. C., and Austad, T., 2003. "Spontaneous Imbibition of Aqueous Surfactant Solutions into Neutral to Oil–Wet Carbonate Cores: Effects of Brine Salinity and Composition." Energy & Fuels, Volume 17, pp. 1133-1144.
78. Strand, S.; Standes, D.C.; and Austad, T., 2004. "New Wettability Test for Chalk." Paper presented at the SPE International Improved Oil Recovery Conference in Asia Pacific held in Kuala Lumpur, Malaysia, October 20-21.

79. Strand, S; Standnes, D.C; and Austad, T; 2006. "New wettability test for chalk based on chromatographic separation of  $SCN^-$  and  $SO_4^{2-}$ ." Journal of Petroleum Science and Engineering, 2006. **52**(1-4): p. 187-197
80. Taber, J. J.; Martin, F.D. and Seright, R. S., 1996. "EOR Screening Criteria Revisited," paper SPE 35385 presented at the 1996 SPE Improved Oil Recovery Symposium, Tulsa, Ok, April 21-24
81. Taugbøl, K., 1995. "Chemical Flooding of Oil Reservoirs. Low Tension Polymer Water Flood." PhD Thesis, Department of Chemistry, University of Bergen, Norway.
82. Thomas, L.K.; Dixon, T. N; Evans, C. E.and Vienot, M. E., 1987. "Ekofisk Waterflood Pilot." Journal Petroleum Technology, February, pp. 221-232.
83. Thomas, M.M.; Clouse, J.A. and Longo, J .M, 1993. "Adsorption of Organic Compounds on Carbonate Minerals 3. Influence on Dissolution Rates." Chemical Geology 109, pp.227-237.
84. Tong, Z. X.; Morrow, N, R. and Xie, X., 2002. "Spontaneous Imbibition For Mixed-Wettability States In Sandstone Induced By Adsorption From Crude Oil." Presented at the 7th International Symposium on Reservoir Wettability, Tasmania, Australia, 12-14 March.
85. Torsæter, O., 1984. "An Experimental Study of Water Imbibition in Chalk from the Ekofisk Field." Paper SPE/DOE 12688 presented at the SOE/DOE Fourth Symposium on Enhanced Oil Recovery, Tulsa, OK. April 15-18.
86. Treiber L. E., Archer, D.L., Owens, W.W., 1972. "A laboratory Evaluation of the Wettability of 50 Oil –Producing Reservoirs." SPE Journal 12, 531-540.
87. Tucker, M. E., 2001. "Sedimentary Petrology: An Introduction to the Origin of Sedimentary Rocks." Blackwell Science, Oxford.
88. Wang,W. and Gupta, A. 1995. "Investigation of the Effect of Temperature and Pressure on Wettability Using Modified Pendant Drop Method." Paper SPE 30544 presented at the SPE Annual Technical Conference and Exhibition held in Dallas, TX, USA, October 22-25.
89. Xie, X.; Morrow, N. R., and Buckley, J. S., 2000. "Contact Angle Hysteresis and the Stability of Wetting Changes Induced by Adsorption from Crude Oil." Paper presented at the 6<sup>th</sup> International Symposium on Reservoir Wettability and Its Effect on Oil Recovery, Socorro, NM, USA. September 27-28.
90. Yousef, A. A.; Al-Saleh, S.; Al-Kaabi, A. and Al-Jawfi, M., 2010. "Laboratory Investigation of Novel Oil Recovery Method for Carbonate Reservoirs," Paper CSUG/SPE 137634, presented at the Canadian Unconventional Resources & International Petroleum Conference, Calgary, Alberta, Canada, 19-21 October.
91. Zhang, P., 2006. "Water-based EOR in Fractured Chalk - Wettability and Chemical Additives." PhD Thesis, University of Stavanger, Norway.
92. Zhang, P.and Austad, T. 2006. "Wettability and Oil Recovery from Colloids and Surfaces A: Physiochemical & Engineering Aspects, 279, 179-187.
93. Zhang, P.; Tweheyo, M.T., and Austad, T., 2007. "Wettability Alteration and Improved Oil Recovery by Spontaneous Imbibition of Seawater into Chalk: Impact of the

- Potential Determining Ions:  $Ca^{2+}$ ,  $Mg^{2+}$ , and  $SO_4^{2-}$ .* Colloids and Surfaces A: Physiochemical & Engineering Aspects, 301, 199-208.
94. Zhou, X.; Morrow, N. R. and Ma, S., 2000. "*Interrelationship of Wettability, Initial Water Saturation, Aging Time and Oil Recovery by Spontaneous Imbibition and Waterflooding.*" SPE Journal, 5(2): 199-207(June).

# Appendix A Equipments and their uses

## A.1 Centrifuge

The instrument used to separate unconsolidated materials from the crude oil samples. Equal volumes of the oil sample were put in two centrifuge bottles and placed on opposite sides, inside the centrifuge. The process was based on the sedimentation principle, where centripetal acceleration caused more dense particles to separate out along the radial directions (at the bottom of the bottle).



**Figure A1:** Centrifuge.

## A.2 Filtration set-up

The SC oil and the brines were filtered through a 0.65 $\mu\text{m}$  and 0.22 $\mu\text{m}$  Millipore filters respectively. The fluid filtration removed any unconsolidated or undissolved particles that could block the chalk core pore throats. Before filtration, the brines were stirred on a magnetic stirrer for about 2 hours to ensure homogeneous mixture. The filtration set-up and the magnetic stirrer are shown in Figure A.2a and A.2b. respectively.



**Figure A.2a:** The filtration set-up

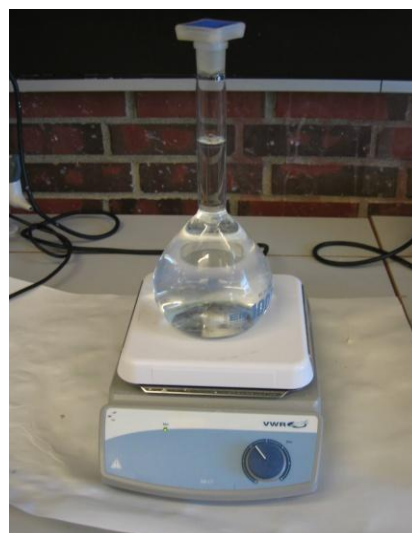

**Figure:A.2b:**Magnetic stirrer

### A.3 Density meter

The density measurements of the oil samples were performed at 20°C, on an Anton Parr DMA 4500 Density Meter shown in Figure A.3. The instrument was first cleaned with white spirit, and then with acetone. A small amount of the oil sample was injected gradually into the tube and the density was determined. The sample should be free of gas bubbles and the measurements were repeated to ensure accuracy.



**Figure A.3:** Density measurement on a DMA 4500 Density Meter



#### A.4 Universal dynamic spectrometer

The viscosity measurements were performed on a Physica UDS 200 Universal Dynamic Spectrometer shown in Figure A.4. The measurements were done at 20°C. The shear rates were set between 10-1000 1/s. and the instrument accuracy was tested with deionized (DI) water. About 2.2 ml of the oil sample fluid was placed on the metal plate. Then, the apparatus was set in measuring position with the plates close to each other. The viscosity of the oil was determined through shear stress/shear rate relation.



**Figure A.4:** Viscosity measurement on a Universal Dynamic Spectrometer

#### A.5 Automatic titrator

A Mettler Toledo DL55 automatic titrator was used to measure the acid and base numbers of different oil samples. The methods used, developed by Fan and Buckley (2007), involved potentiometric titrations using an internal standard. They are the modified versions of ASTM D2896 for base number and ASTM D664 for acid number titration. Figure A.5 shows the instrument and Table A.1 outlines the procedures for acid number titration of the crude oil samples



**Figure A.5:** Automatic titrator for measuring the AN and BN of the oil samples.

Table A.1: The procedures for the acid number titration of the crude oil samples

Solutions	Chemicals	Description
Titrant	KOH (>85 %) 2-propanol	2.8 g KOH (>8.5 %) was diluted to 1000 ml with 2-propanol
Spiking solution	Stearic Acid Acid titration solvent	0.5 g Stearic Acid was diluted to 500 ml with DI Water
Standard solution	Potassium Hydrogen Phthalate (KHP)	0.2 g KHP was diluted to 500 ml with DI Water
Titration solvent Acid titration solvent	DI Water 2-propanol (HPLC) Toluene (HPLC)	6 ml DI Water was diluted with 494 ml HPLC-grade 2-propanol and with 500 ml HPLC-grade Toluene.

## A.6 Vacuum container

This was used to saturate the chalk cores during core cleaning with DI water, and pore volume estimation using the formation brine. Each core was placed in a vacuum container and evacuated to remove any trapped fluids before it was saturated.



Figure A.6: Core saturation set-up

## A.7 Hassler core holder

The instrument was used for core flooding, both in core handling and in the chromatographic wettability tests. The HPLC pump model 305, with a 10SC piston head, delivered by Gilson was used in core flooding experiment and the fraction collector model 222 XL was used in the wettability tests. The chalk core was placed inside a rubber sleeve in a central position and then inserted inside the core holder. Then, a confining pressure of 25bar was applied.

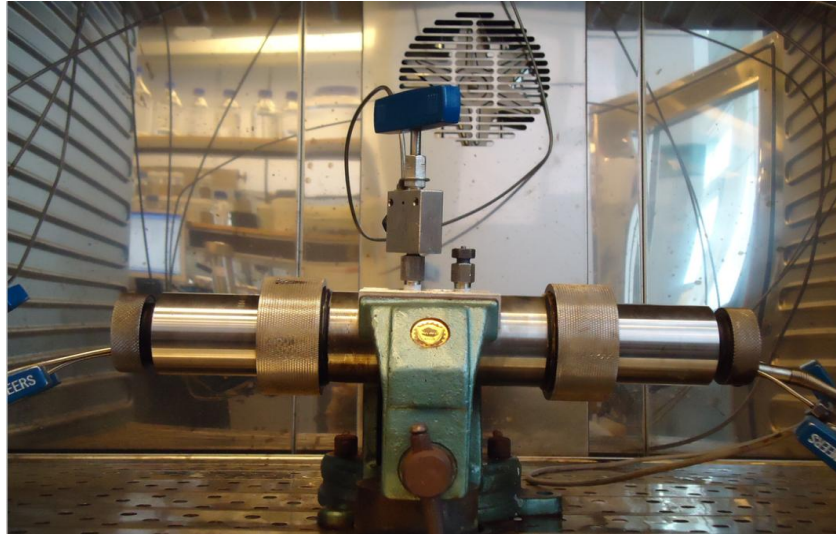
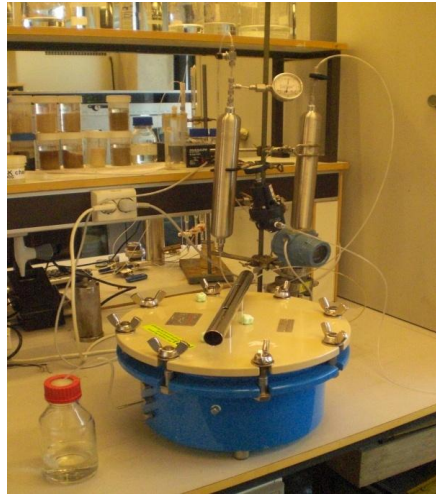

Figure A.7: Hassler core holder used for all core flooding.

## A.8 Porous plate

To establish  $S_{wi}$  of 10 %, the 100 % VB0S-saturated cores were drained on the porous plate, using water-saturated nitrogen gas. As the pressure in the porous plate was gradually increased to 8.5bar, the total water saturation decreased. Then, the actual initial water saturation for the core was determined using The initial water saturation,  $S_{wi}$  of about 10% was established by draining 100 % VB0S-saturated cores on the porous plate using water saturated nitrogen gas, given by Figure A.8a. The water saturation decreased as the pressure in the porous plate was gradually increased to about 8.5 bar, as shown in Figure A.8b.



**Figure A.8a:** Establishing initial water saturation on a porous plate.

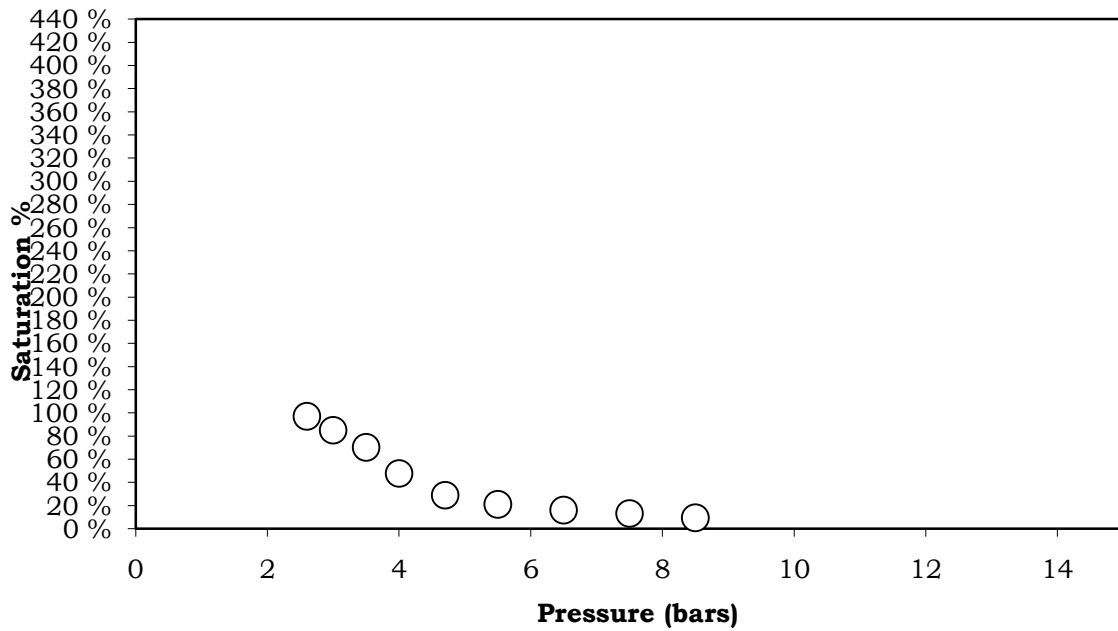

**Figure A.8a:** The plot showing decreasing water saturation as pressure was gradually increased in the porous plate technique.

## Appendix B Experimental data

### B.1 Spontaneous imbibition at 90°C

**Table B.1:** Oil recovery from the chalk cores imbibed with different imbibing brines, as a function of time.

Time (days)	Cumulative Oil Recovery(ml)				Recovery factor			
	SW#1	SW#6	SW#3	SW#5	SW#1	SW#6	SW#3	SW#5
0	-	0.0	0.0	0.0	-	0 %	0 %	0 %
0	-	1.0	2.7	2.5	-	3 %	8 %	8 %
1	-	4.7	7.0	9.3	-	14 %	22 %	28 %
2	-	6.4	8.6	1.2	-	20 %	27 %	37 %
3	0	7.2	9.4	13.2	0 %	22 %	29 %	40 %
4	0.4	7.7	10.1	14.2	1 %	24 %	31 %	43 %
5	1.4	8.3	10.7	15.2	4 %	25 %	33 %	46 %
6	1.7	8.7	11.1	15.6	5 %	27 %	35 %	47 %
8	2.5	9.3	11.7	16.6	7 %	28 %	36 %	50 %
10	2.9	9.8	12.1	17.1	9 %	30 %	38 %	51 %
12	3.2	10.2	12.7	17.9	10 %	31 %	40 %	54 %
14	3.6	10.5	13.3	18.4	11 %	32 %	41 %	55 %
16	3.9	10.8	13.4	18.7	12 %	33 %	42 %	56 %
20	4.3	11.2	13.8	19.6	13 %	34 %	43 %	59 %
23	4.7	11.5	14.0	19.8	14 %	35 %	44 %	59 %
28	5.3	12.0	14.5	20.3	16 %	37 %	45 %	61 %
31	5.5	12.2	14.7	20.5	16 %	37 %	46 %	62 %
34	5.6	12.3	14.8	20.7	17 %	38 %	46 %	62 %
37	5.6	12.4	14.9	20.8	17 %	38 %	46 %	62 %

Note:

Brine	Core ID	OOIP (ml)
VB0S	SW#1	32.85
SW	SW#6	32.70
SW0NaCl	SW#3	32.11
SW4S0NaCl	SW#5	33.29

## B.2 Spontaneous imbibition at 70°C

**Table B.2:** Oil recovery from the chalk cores, imbibed with different imbibing brines, as a function of time.

Time (days)	Cumulative oil Recovery(ml)			Recovery factor		
	SW#9	SW#8	SW#7	SW#9	SW#8	SW#7
0	0.0	0.0	0	0 %	0 %	0 %
0	3.3	2.8	2.3	11 %	9 %	7 %
1	7.6	8.0	7.0	24 %	26 %	23 %
1	8.3	9.0	7.7	27 %	29 %	25 %
2	8.9	9.7	9.0	28 %	31 %	29 %
3	9.6	10.5	10.2	31 %	34 %	33 %
4	9.9	11.0	10.7	32 %	35 %	35 %
7	10.8	11.9	12.2	35 %	38 %	39 %
8	11.0	12.2	12.4	35 %	39 %	40 %
10	11.3	12.7	12.9	36 %	41 %	42 %
15	11.8	13.3	13.9	38 %	43 %	45 %
18	12.0	13.6	14.3	38 %	44 %	46 %
21	12.2	13.8	14.6	39 %	44 %	47 %
23	12.3	13.9	14.8	39 %	45 %	48 %
25	12.3	14.0	15.0	39 %	45 %	48 %
27	12.4	14.0	15.0	40 %	45 %	48 %
30	12.6	14.2	15.4	40 %	46 %	50 %
33	12.6	14.2	15.6	40 %	46 %	50 %
39	12.7	14.3	15.8	41 %	46 %	51 %
43	12.8	14.4	15.9	41 %	46 %	51 %

Note:

Brine	Core ID	OOIP (ml)
SW	SW#9	31.24
SW0NaCl	SW#8	31.11
SW4S0NaCl	SW#7	31.01

### B.3 Chromatographic wettability analyses

**Table B.3:** Corrected relative ion concentrations of  $\text{SO}_4^{2-}$  and  $\text{SCN}^-$ , from the effluent samples of VB0S and SW respectively.  $T_{im} = 90^\circ\text{C}$ .

Core VB0S, SK#1			Core SW, SK#6		
PV	SCN	SO4	PV	SCN	SO4
0,094	0,000	0,000	0,097	0,000	0,000
0,268	0,000	0,000	0,279	0,000	0,000
0,346	0,000	0,000	0,359	0,000	0,000
0,424	0,000	0,000	0,439	0,000	0,000
0,502	0,000	0,000	0,519	0,000	0,000
0,581	0,000	0,000	0,599	0,039	0,000
0,659	0,028	0,000	0,680	0,115	0,000
0,738	0,174	0,017	0,761	0,287	0,065
0,816	0,504	0,137	0,841	0,537	0,162
0,894	0,782	0,316	0,922	0,851	0,361
0,972	0,932	0,557	1,004	1,000	0,610
1,051	0,962	0,842	1,085	1,000	0,800
1,129	1,000	0,898	1,166	1,000	0,947
1,208	1,000	0,949	1,247	1,000	1,000
1,286	1,000	0,974	1,328	1,000	1,000
1,371	1,000	1,000	1,415	1,000	1,000
1,476	1,000	1,000	1,521	1,000	1,000
1,580	1,000	1,000	1,629	1,000	1,000
1,711	1,000	1,000	1,762	1,000	1,000
1,919	1,000	1,000	1,975	1,000	1,000
2,127	1,000	1,000	2,188	1,000	1,000

**Table B.4:** Corrected relative ion concentrations of  $\text{SO}_4^{2-}$  and  $\text{SCN}^-$ , from the effluent samples of SW0NaCl and SW4S0NaCl respectively.  $T_{im} = 90^\circ\text{C}$ .

Core SW0NaCl, SK #3			Core SW4S0NaCl, SK #5		
PV	SCN	SO4	PV	SCN	SO4
0,098	0,000	0,000	0,094	0,000	0,000
0,282	0,000	0,000	0,272	0,000	0,000
0,364	0,000	0,000	0,352	0,000	0,000
0,446	0,000	0,000	0,430	0,000	0,000
0,528	0,000	0,000	0,510	0,000	0,000
0,611	0,014	0,000	0,590	0,000	0,000
0,694	0,095	0,000	0,670	0,047	0,000
0,776	0,313	0,072	0,750	0,225	0,000
0,857	0,619	0,203	0,831	0,491	0,066
0,940	0,830	0,434	0,910	0,798	0,303
1,022	0,942	0,629	0,991	0,928	0,501
1,105	0,989	0,723	1,070	0,975	0,663
1,187	1,000	0,855	1,151	1,000	0,852
1,269	1,000	0,935	1,231	1,000	0,870
1,352	1,000	0,950	1,311	1,000	0,954
1,442	1,000	0,984	1,397	1,000	0,983
1,552	1,000	1,000	1,503	1,000	1,000
1,663	1,000	1,000	1,609	1,000	1,000
1,800	1,000	1,000	1,742	1,000	1,000
2,020	1,000	1,000	1,954	1,000	1,000
2,238	1,000	1,000	2,154	1,000	1,000



**Table B.5:** Corrected relative ion concentrations of  $\text{SO}_4^{2-}$  and  $\text{SCN}^-$ , from the effluent samples of SW, SW0NaCl, and SW4S0NaCl respectively.  $T_{im} = 70^\circ\text{C}$ .

Core SW, SK#7			Core SW0NaCl, SK#8			Core SW4S0NaCl, SK#9		
PV	SCN	SO4	PV	SCN	SO4	PV	SCN	SO4
0,218	0	0	0,215	0	0	0,21	0	0
0,336	0	0	0,332	0	0	0,323	0	0
0,503	0	0	0,414	0	0	0,402	0	0
0,586	0,16	0	0,498	0	0	0,481	0	0
0,668	0,35	0,193	0,582	0	0	0,56	0	0
0,75	0,59	0,332	0,666	0,15	0,021	0,64	0	0
0,832	0,77	0,483	0,75	0,38	0,072	0,72	0,18	0
0,909	0,94	0,627	0,835	0,69	0,225	0,799	0,47	0,026
0,992	0,98	0,773	0,919	0,82	0,344	0,878	0,77	0,124
1,074	1	0,861	1,087	0,96	0,618	0,958	0,91	0,358
1,157	1	0,926	1,171	0,98	0,693	1,038	0,92	0,63
1,242	1	0,946	1,255	1	0,901	1,116	1	0,794
1,325	1	1	1,338	1	0,912	1,196	1	0,86
1,408	1	1	1,421	1	1	1,275	1	0,94
1,515	1	1	1,525	1	1	1,356	1	1
1,626	1	1	1,636	1	1	1,456	1	1
1,737	1	1	1,748	1	1	1,668	1	1
1,927	1	1	1,941	1	1	1,852	1	1
2,148	1	1	2,162	1	1	2,065	1	1
2,369	1	1	2,384	1	1	2,276	1	1
2,369	1	1	2,384	1	1	2,276	1	1
2,369	1	1	2,384	1	1	2,276	1	1