

UNIVERSITY OF STAVANGER

MASTER THESIS

**Extension and Modification of
Anticipatory Failure
Determination Approach Based
on I-TRIZ**

Author:

Eze SUNDAY

Supervisor:

Prof. Terje AVEN

*A thesis submitted in fulfilment of the requirements
for the degree of Master of Science in Engineering*

in the

-

Department of Mechanical and Structural Engineering

June 2014

Declaration of Authorship

I, Eze SUNDAY, declare that this thesis entitled, 'Extension and Modification of Anticipatory Failure Determination Approach Based on I-TRIZ' and the work presented in it are mine. I attest that:

- This work was done wholly while in candidature for Master degree at University of Stavanger.
- Where any part of this thesis has previously been submitted for a degree or any other qualification at University of Stavanger or any other academic institution, this has been clearly stated.
- Where I have consulted the published work of other authors, this has been clearly indicated.
- Where I have quoted from the work of others, the source is provided. With the exception of the above mentioned items, this thesis is entirely my work.
- I acknowledged all principal sources of help.
- I stated those attestations in confidence and good faith.

Signed:

Date:

“Concern for man himself and his safety must always for the chief interest of all technical endeavours.”

Albert Einstein

UNIVERSITY OF STAVANGER

Abstract

Faculty of Science and Technology
Department of Mechanical and Structural Engineering

Master of Science in Engineering

Extension and Modification of Anticipatory Failure Determination Approach Based on I-TRIZ

by Eze SUNDAY

Anticipatory failure determination, abbreviated as AFD, is qualitative risk analysis approach that is based on I-TRIZ, a Russian short form of theory of inventive problem solving. Although this approach comprises two methods, AFD-1 and AFD-2, which are methodically structured to capture failure scenario that has occurred or predict and reveal future failures that have not occurred respectively, it has shortcomings and weaknesses which are very important to address and eliminate.

In this thesis, weaknesses and shortcomings of the approach are explored, AFD-1 and AFD-2 are modified, and new AFD method named AFD-3 is created. The two modified AFD methods and newly created AFD-3 are based on SIVAI-TRIZ which is extended form of I-TRIZ for solving inventive problem. The modified methods and newly created AFD-3 offer higher degree of flexibility, effectiveness, and empowerment to reveal, predict and capture system failure scenarios. SIVAI-TRIZ body of knowledge is realized by applying system design approach to risk analysis through embedding design structure matrix (DSM) and design matrix (DM) of axiomatic design on AFD methods to address AFD shortcomings and augment I-TRIZ body of knowledge.

Acknowledgements

I thank my thesis supervisor for his professorial guidance and direction. Prof. Terje Aven has been encouraging and motivating to ensure that the purpose of this thesis is accomplished. My thanks of appreciation go to other professors who had lectured me here in University of Stavanger - your dedications are the fertile seeds of this accomplishment.

Also, my family played significant role in my success. Many thanks go to my mother for her incomparable love, care, and support.

Contents

Declaration of Authorship	i
Abstract	iii
Acknowledgements	iv
Contents	v
List of Figures	viii
Abbreviations	ix
1 Introduction	1
1.1 Thesis Background	2
1.1.1 Failure Localization in AFD Method	2
1.1.2 Process of Revealing Scenario	3
1.2 Thesis Problem Statement	5
1.3 Thesis Purpose	5
1.4 Significance of Thesis Research	6
2 Literature Review	7
2.1 Quantitative Risk Analysis	7
2.2 Qualitative Risk Analysis	9
2.3 Principle of Scenario Structuring	9
2.3.1 Principle of Success State of a System, S_0	9
2.3.2 Principle of Initiation	10
2.3.3 Principle of Emanation	11
2.3.4 Principle of Unending Cause-Effect	11
2.3.5 Principle of Subdivision	12
2.3.6 Pinch Point Principles	12
2.3.7 principle of Resources	13
2.4 Methods of Revealing Scenarios	14

2.4.1	Failure Mode and Effect Analysis (FMEA)	14
2.4.2	Fault Tree Analysis (FTA)	16
2.4.3	Event Tree Analysis	16
2.4.4	Hazard and Operability Analysis	16
2.4.5	Anticipatory Failure Determination Approach, AFD	18
2.4.6	I-TRIZ Based AFD-1 Template	18
2.4.7	I-TRIZ Based AFD-2 Template	24
3	Shortcomings of AFD Method	27
3.1	Omission of System Interactions	27
3.1.1	Remedy for Omission of System Interactions	28
3.2	Neglect of System Integrality	29
3.2.1	Modularity and Integrality	29
3.2.2	Singular Modularity Index	29
3.2.3	Remedy for Neglect of System Integrality	32
3.3	Prepermission of Vulnerability Analysis	32
3.3.1	Remedy for Prepermission of Vulnerability Analysis	34
3.4	Neglect of Axiomatic Design Framework	35
3.4.1	Transformation of DM to DSM	38
3.4.2	Essential Step to Transforming DM to DSM	39
3.4.3	Remedy for AFD Weakness to Human Failures	42
4	SIVAI-TRIZ Based AFD-1	43
4.1	SIVAI-TRIZ Based AFD-1 Template	43
5	SIVAI-TRIZ Based AFD-2	52
5.1	SIVAI-TRIZ Based AFD-2	52
6	SIVAI-TRIZ Based AFD-3	57
6.1	AFD-3 Template	58
7	Practical Examples	64
7.1	Radiation Pyrometer Failure Analysis	64
7.1.1	Application of SIVAI-TRIZ Based AFD-1	65
7.2	Prediction of Future Failures of Boiler	74
7.2.1	Application of SIVAI-TRIZ based AFD-2	75
7.3	Failure in Complex Manufacturing System	79
7.3.1	Application of SIVAI-TRIZ based AFD-3	79
7.4	Summary and Conclusion	85
7.5	Future Work	86
A	Appendix A	87
A.1	Theory of Inventive Problem Solving (TRIZ)	87
A.1.1	Principles of TRIZ	88

A.1.2	Ideality Principle	88
A.1.3	Principle of Maximal Use of Resources	89
A.1.4	Principle of Contradiction	90
A.2	AFD Thought-Process Cycle	90
A.3	Design Structure Matrix(DSM)	94
A.4	How to Use DSM to Predict Failures	96
A.5	Transformation Method	99
B	Appendix B	101
B.1	Code Used for Simulation	101
	Bibliography	104

List of Figures

1.1	AFD Failure Localization	4
2.1	Simple Architecture of Cryptographic System	8
2.2	Rocket Launching Stages	10
2.3	Principle of Initiation	11
2.4	Scenario Tree Emanating from Initiating Event	12
2.5	Pinch Point in Scenario Tree	13
2.6	FMEA Matrix for Revealing Complete Scenarios	15
2.7	HAZOP Matrix Concept for Revealing Complete Scenarios	17
2.8	Changing a Problem to Inverted Problem	21
2.9	Process of Searching in AFD	22
2.10	Flow Chart for Algorithm of Inventive Problem Solving	23
3.1	Fully Integral System, Bus-Modular System, Fully Modular System.	30
3.2	Modularity Verses Sparsity for 15 Products.	31
3.3	Engineering Concept of Product Design	33
3.4	Example of System Architecture	33
3.5	Basic Scenario Tree of Figure 3.4 Using AFD Approach	34
3.6	Scenario Tree of Figure 3.4 Considering all Parts	34
3.7	Axiomatic Design Framework	36
3.8	Zigzagging Process of Decomposing FR to DP	37
3.9	Framework for Managing System Knowledge	38
4.1	Block Diagram of Radiation Pyrometer	44
4.2	Schematic of Optical System	48
7.1	Graph of $\sum_{i=1}^N \left \frac{\alpha_i}{\alpha_1} - \exp \frac{1-i}{\Phi} \right $ against Φ	67
7.2	Second Graph of $\sum_{i=1}^N \left \frac{\alpha_i}{\alpha_1} - \exp \frac{1-i}{\Phi} \right $ against Φ	70
7.3	Schematic of Biomass Bioler	74
7.4	Schematic of Aircraft Fuel System	80
7.5	Exemplary Block Diagram of Fuel Filter	81
A.1	Solution by Abstraction	91
A.2	Solution by Abstraction Using Differential Equation	93
A.3	System Block Diagram	95
A.4	Simple Block Diagram	97

Abbreviations

AFD-1	Anticipatory Failure Determination for Failure Analysis
AFD-2	Anticipatory Failure Determination for Failure Prediction
AFD-3	Anticipatory Failure Determination for Capturing Human Failure
I-TRIZ	Innovation Theory of Inventive Problem Solving
SIVAI-TRIZ	System Interaction Vulnerability Analysis I-TRIZ
FTA	Failure Tree Analysis
EVT	Event Tree Analysis
HAZOP	Harzard and Operability Analysis
DM	Design Matrix
DSM	Design Structure Matrix
SMI	Singular Modularity Index
NZF	Non-Zero Fraction
RA	Risk Analysis
ES	End State
BES	Benign End State
HES	Harmful End State
FMEA	Failure Mode Effect Analysis
FMECA	Failure Mode Effect Criticality Analysis
ARIZ	Algorithm for Inventive Problem Solving
IE	Initiating Event
MS	Middle State
S_0	Success Scenario

To the Memory of my father, Mr. Eze Nweke T.

Chapter 1

Introduction

In all walks of life and endeavors, primary concern for man is security of life and protection of environment and other sources of livelihood. History has showed that even early scientists and engineers made safety integral part of system design even though risk science was not well developed at that time. This is evident in one of Albert Einstein's quotes "concern for man himself and his safety must always for chief interest of technical endeavors." By the quote, it becomes obvious and can be easily concluded that Albert Einstein foresaw trend of risk science and rhapsodized on the importance of incorporating philosophy of safety in all walks of man's life to make such quote.

Although the quote may seem ordinary, it carries details of evolution of risk science and its importance to improve system engineering designs. Technical dissection of the quote not only indicates that usefulness of a technical system and activity is dependent on acceptable degree of safety but safety itself determines design and creation of technical system, which has set frontiers for evolution of risk science over the last two decades. The evolution can be traced in quantitative risk analysis as well as qualitative risk analysis which anticipatory failure determination (AFD) is a part.

1.1 Thesis Background

Anticipatory failure determination (AFD) methods are new RA methods which are methodized to either perform risk analysis or predict future failures of a system. They are categorized into two versions, which are AFD-1 and AFD-2. The two versions are superior to other RA methods because they are based on principles of TRIZ, an acronym for theory of inventive problem solving. In those two versions, TRIZ principles are embodied which provide mechanism for using analytical approach to reveal scenarios rather than trail-and-error approach that is evident in FTA, FMEA or HAZOP method. Use of analytical approach to reveal failure scenario is strength of AFD methods.

Generally, AFD strength comes from two important steps: first step is localization of region from which problem (failure) emanates in a system and second step is using analytical approach to reveal failure scenario. In AFD, essence of using analytical approach to reveal root causes of a problem is due to the fact that when scenario is analytically revealed with variables (resources) of condition in which the problem occurred, the revealed scenario carries information that can be used to prevent the failure and improve system safety. The practice of using variables of condition in which a failure occurred to reveal its scenario aligns with TRIZ principle of resources [1].

1.1.1 Failure Localization in AFD Method

In AFD methods, problem formulation, description of system success scenarios, and FMEA method are extensively used to localize failure in a system [1]. AFD methods are structured in way that it is very important to formulate original problem that occurred and state success scenarios to define system behaviors. To formulate a problem (failure) that occurred in a system, it is required that the problem must be explicitly described and variables of condition in which the problem occurred be clearly stated to define problem boundary. To state system success scenario, it is required that success scenario of each subsystem be stated to describe phase behaviors and overall system behavior. After describing the problem (failure) and variables of condition in which the failure occurred, problem is localized by comparing formulated problem with failure effect (of success scenarios) as illustrated in figure 1.1. While comparing formulated problem with failure

effect, any failure effect that matches the description of the formulated problem is indicator of the failure source.

As illustrated in figure 1.1, AFD failure localization process is linear. As such, the process is appropriate for a system which its subsystems are linearly connected such as modular system. Although AFD failure localization process is appropriate to localize failure in modular system since its subsystems are linearly arrayed and connected, it lacks framework to localize failure in a system in which subsystems are arrayed to facilitate efficiency or flows in different directions such as integral system; as such, AFD failure localization process constitutes knowledge gap, which must be addressed since today's systems are as much modularized as they are integrated according to research by Hölttä et al [2].

Notwithstanding the knowledge gap, what about system interactions between two or among more than two subsystems? From system engineering point of view, a system comprises many interrelated, interdependent components which are interacting to deliver one or more goals. It is technically evident from the definition that system behavior, structure, and form of connection depend on interactions among components [2]. As such, neglect of system interactions in AFD failure localization constitutes second knowledge gap.

1.1.2 Process of Revealing Scenario

In AFD-1 method, scenario is revealed through problem inversion, method identification, and solution specialization. Problem inversion means that a formulated problem must be rephrased in such a way that analysis will be focused on how to produce the problem. Method identification is a step towards solving inverted problem; at this stage, general method of solving a formulated problem is identified through searching different database and other sources of information. When the method is identified, resources used in the identified method are compared with resources in the formulated problem. If resources that are used in the identified method are present in the problem (that occurred in the system), it means that both problems belong to same problem abstract category and solution abstract category (general solution) [2]. Then, specialization of the general solution to particular solution to formulated problem can be done using details of problem formulation, resources, and condition in which the failure occurred [1, 2]. In some

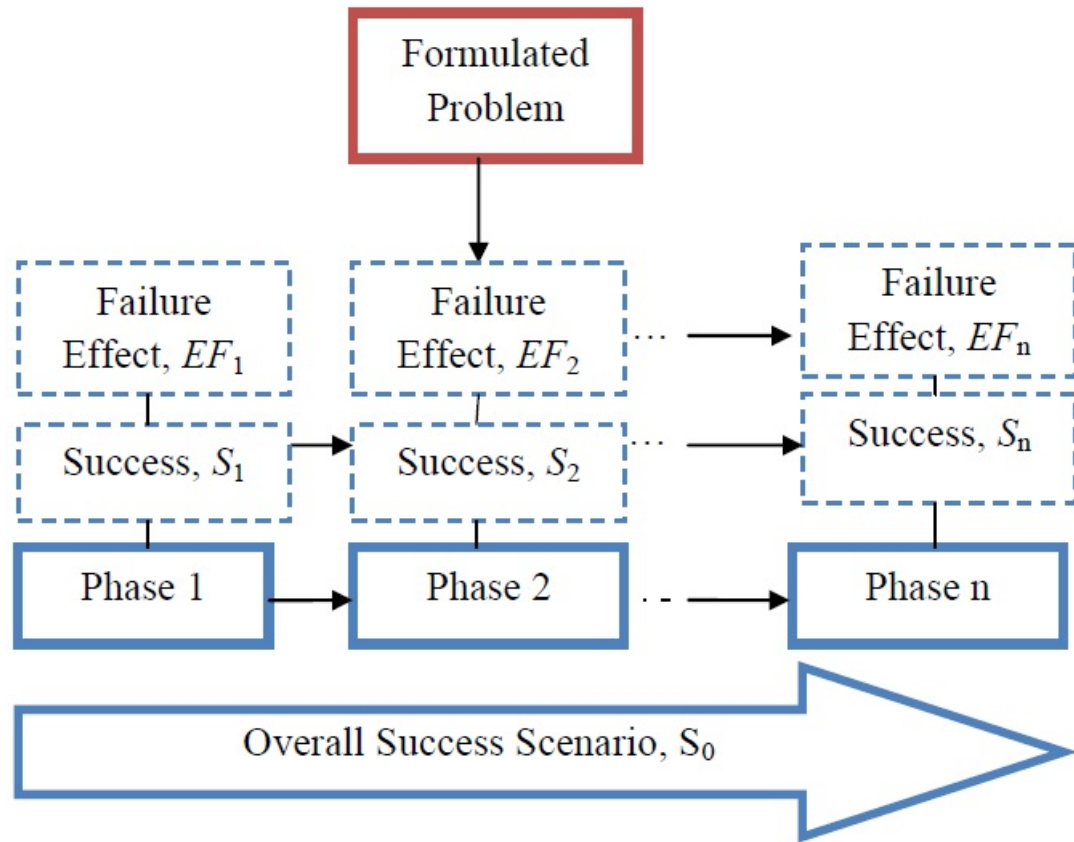

FIGURE 1.1: AFD Failure Localization Process

cases where scenario cannot be fully revealed using available resources, ARIZ, algorithm for inventive problem solving, is applied [1]. This is fully explained in Appendix A.

In AFD-2 method, end states are identified by individually considering failure of each subsystem assuming other remaining subsystems are functioning as desired, which is typical FMEA method. The middle states are identified by considering system resources. What about end states and middle states that can appear because of vulnerability of the subsystems or differential vulnerability of components that are arrayed and connected in a subsystem? It is technically evident that some parts can fail because of vulnerability of other parts to processes and system resources [3]. Vulnerability analysis is crucial to reveal different possibilities of failure initiation, but it is not considered in AFD-2 method for predicting future failures (end states and middle states). Thus, omission of vulnerability analysis also constitutes third knowledge gap of AFD methods.

To bridge the knowledge gaps, this research work covers spectrum of shortcomings

that are inherited when AFD-1 and AFD-2 are used to perform risk analysis; in the research work, AFD shortcomings, solutions to eliminate the shortcoming, and modified AFD methods are presented. New method named AFD-3 is methodized to link system failure or product failure to manufacturing system using design structure matrix (DSM) and design matrix (DM) of axiomatic design. AFD-3 is structured to capture human failure and ergonomic failure. I-TRIZ tool is extended to SIVAI-TRIZ, to manage knowledge base of system interactions. The thesis is organized as thus:

In Chapter 1, introduction, thesis background, thesis problem statement, and thesis purpose are presented.

Literature review of theory of scenario structuring, AFD-1 and AFD-2 are presented in chapter 2. The concept of AFD that is presented is based Kaplan's work. In chapter 3, shortcomings that appear when AFD-1 and AFD-2 are used are thoroughly explained along with good solutions to address them.

Template of modified AFD-1 is presented and explained in chapter 4; template of modified AFD-2 is explained in chapter 5 and template of newly created AFD-3 is presented in chapter 6.

In chapter 7, examples are used to illustrates the modified AFD methods and newly created AFD-3 methods. Conclusion and future work are also stated.

1.2 Thesis Problem Statement

Shortcomings are inherited in RA solution in which AFD methods are used because of knowledge gaps due to: neglect of system interactions, pretermission of vulnerability analysis, and linearity of AFD failure localization.

1.3 Thesis Purpose

The primary focus of this thesis is to modify and methodize AFD to possess capabilities which can be used to localize failure in any complex system architecture and reveal its scenario. AFD methods must be empowered with technical capabilities to not only localize problem situated in any level of system architecture or

capture failure due to component differential vulnerabilities, but to also capture failure due to human error and poor ergonomic design. These purposive goals can only be achieved when a solution that bridges the AFD knowledge gaps are fabricated to technically address the shortcomings.

1.4 Significance of Thesis Research

There is technical need to structure RA methods that use system engineering concept to predict and reveal failure scenarios. Such approach can reveal failures that are attributed to a system, augment design information, improve safety, and increase knowledge of system interactions and behaviors. The following new approaches are implemented to AFD to bridge the knowledge gaps.

In the newly modified AFD methods, design structure matrix (DSM) is embedded in its templates to capture all flows, interactions, and emergent behaviors that characterize mechanism of a system. The design structure matrix is used to trace problem or predict future failures; DSM is essentially used to examine, localize, identify or predict future problem in any level of system architecture irrespective of whether integrated system or modularized system. This tool characterizes AFD methods with capability which can be utilized to predict future failures with respect to flows, flow paths, and system behaviors.

Transformation method is imbedded in AFD methods to map design information from design matrix (DM) of axiomatic design to DSM, which is essential to empower AFD to capture failure due to human error or poor ergonomic design.

Also, vulnerability analysis is inclusive in AFD framework to create capability with which to capture failures and failure propagation due to component differential vulnerability and system vulnerability to flow intensities and natural system (environment).

Chapter 2

Literature Review

Risk analysis is discipline that demands high degree of expertise because of its application in various endeavors, which abut engineering, research, business, reliability, food safety, planning, military defense. In various field of engineering, risk analysis is hallmark of decision making. It is subdivided into two branches; first branch is centered on identification of failure and revelation of failure scenario. Second branch is based on probabilistic calculation or estimation of metric value with which decision is made. The former is called qualitative risk analysis and the latter is called quantitative risk analysis. Although both are complement of each other, qualitative risk analysis will take major part of this thesis. Quantitative risk analysis will be slightly discussed merely to show complete blocks of RA analysis.

2.1 Quantitative Risk Analysis

Quantitative risk analysis, abbreviated as QRA in various literatures, is RA analysis that is concerned with probabilistic calculation or estimation of likelihood that an event can occur. This branch of risk analysis comprises three basic steps and these are:

- *finding what can go wrong,*
- *Probabilistic modeling or probability estimation of what can go wrong*
- *Consequence evaluation of ‘what can go wrong if they would occur. .*

The first, *finding what can go wrong*, is where more energy and time are invested in RA analysis because it is a step in which list of what can go wrong are identified and listed. FMECA, FTA, ETA and AFD are tools created for this purpose. Probabilistic modeling or estimation is used to establish percentage of possibility that what can go wrong can occur. Consequence evaluation is usually based on number of deaths, damages that can be impacted by what can occur. FMECA, FTA, ETA and AFD are mainly used for this purpose. Figure 2.1 below illustrates these three steps using cryptographic system.

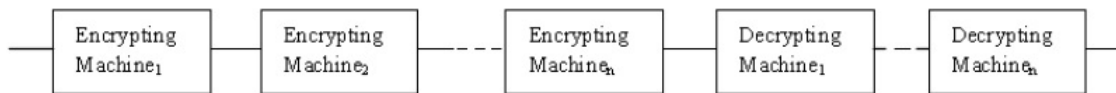

FIGURE 2.1: Simple Architecture of Cryptographic System

Figure 2.1 is an example of linear system with desired state, S_0 . The system can only reach its state if all its subsystems reach their end states; otherwise, the overall system cannot reach its state. For Example, mechanism would stop at machine1 if encrypting machine1 failed, and the same would happen if others failed. Any failure of the subsystems must force system mechanism to different part or end states. This is the basic principle on which FMECA, ETA, FTA, AFD and other tools are based and it is called scenario structuring in risk analysis. Recurrent process is applied in FMECA to determine scenario structure. In every instance of finding failure using FMECA, it is commonly assumed that all subsystems are functioning as desired with exception of one in order to examine and state failure at level of the subsystem. This process is repeated for a number of components in a system. This forward process generates n -number of scenarios, $\{S_1, S_2, S_3, \dots, S_n\}$, for n -number of components, $\{C_1, C_2, C_3, \dots, C_n\}$. The recurrent process of FMECA is evident also in AFD, but AFD method is more powerful because it has forward method and backward method of finding failures, which is combination of FMECA, FTA, HAZOP, and ETA concepts.

Considering likelihoods L_i and consequences C_i of the scenarios, risk of a system can be stated as triplets:

$$R_i = (S_i, L_i, C_i) \quad (2.1)$$

2.2 Qualitative Risk Analysis

Qualitative risk analysis has been explained to an extent; its main purposes are for revealing and identifying scenarios. It comprises many methods as indicated and explained in the introductory part of this thesis. In this part, the methods of qualitative risk analysis are explained as variant of theory of scenario structuring.

2.3 Principle of Scenario Structuring

Principle of scenario structuring is principle that explains failure mechanism. This principle recognizes that a system consists of subsystems that make up its network and a subsystem consist of components that are networked together; this principle maintains that a system failure which is deviant from desired state, S_0 , occurs because of failure of either subsystem or components, which happened as result of emergence of unexpected interactions or negative impact of resources within or outside the system. A Set of principles which are constituted in principle of scenario structuring are detailed in the following.

2.3.1 Principle of Success State of a System, S_0

This principle indicates that knowledge of an activity or system success, S_0 , is prerequisite for analysis and must be stated at onset before performing RA analysis. System success is intended function or expected outcome of an activity in this context. In practical sense, this principle suggests that before carrying out risk analysis of either an activity or a system, knowledge of system architecture and functions of subsystems (components) that make up a system are prerequisite to start risk analysis; if it an activity, stages and their expected success scenarios should be known and clearly indicated before performing RA analysis. Example is given in the following.

With respect to principle of success state, carrying out risk analysis of rocket launching as showed in the above depicted diagram needs that one should have insightful knowledge of success scenarios of its phases and the activity of rocket launching itself. Clearly stating and indicating success scenarios before starting analysis defines boundary of a problem.

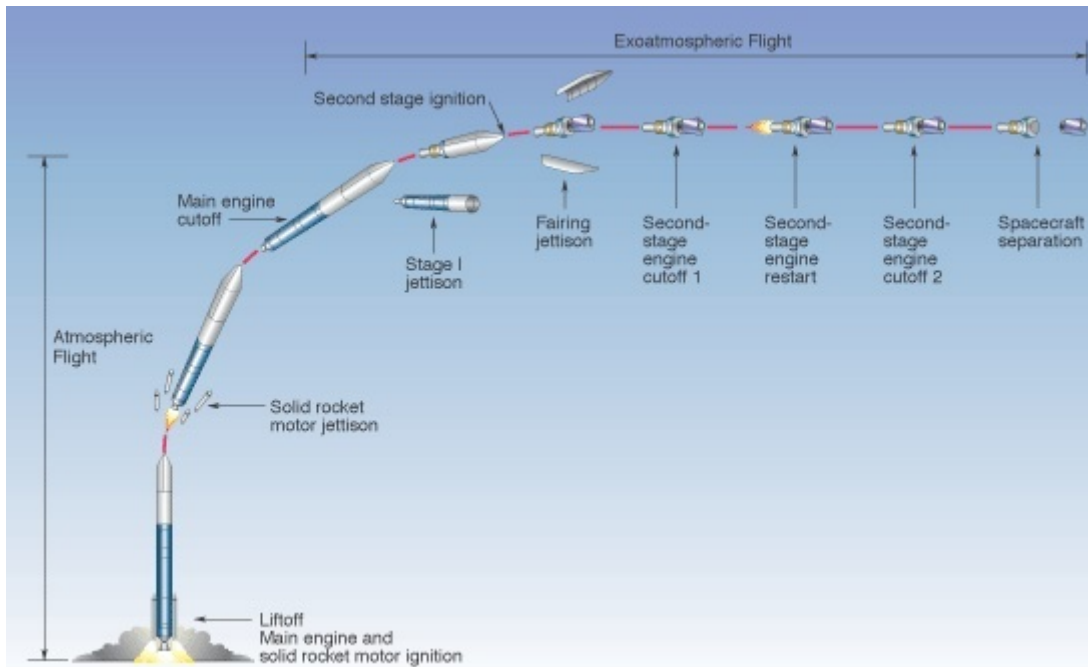

FIGURE 2.2: Rocket Launching Stages [4]

According to principle of success scenario, factors that can be considered before starting risk analysis are such as system architecture, functionalities of subsystems, functionalities of components, robust subsystem, resilient subsystem, reliability block diagram (2-out-of-3 system, 3-out-of-5 system, et cetera), system interactions, resources et cetera.

2.3.2 Principle of Initiation

This principle states that a subsystem (phase) failure has its end states which is deviant from intended subsystem (phase) purpose. In other words, it means that a subsystem or phase failure forces a system in which it is constituted to depart from its path of success scenario. Such departure from intended path is labelled end state in typical language of scenario structuring. This process of failure mechanism is called initiation of event or Initiation of failures. Using figure 2.3 as example, a failure can emanate from any phase of rocket launching and each end states are represented with triangular or circle dot. Principle of initiation is well supported by typical FMECA analysis. It represents the forward process of identifying failures in AFD method.

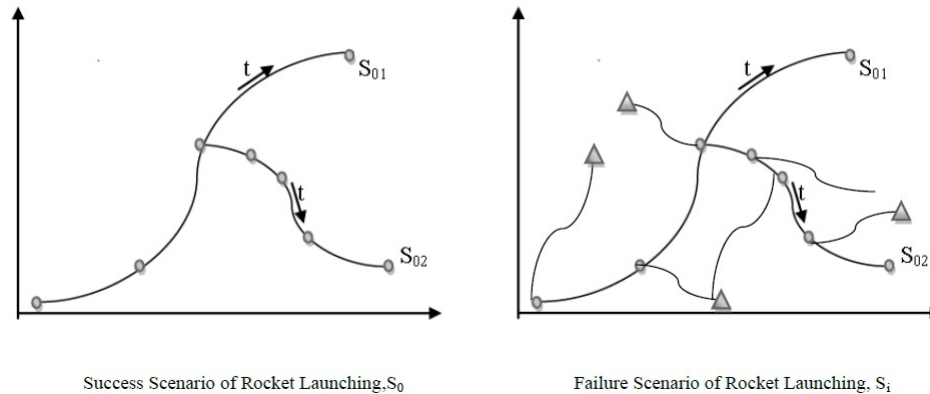

FIGURE 2.3: Principle of Initiation

2.3.3 Principle of Emanation

Principle of emanation states that there are outgrowths of scenarios from a branch of initiating event right after failure initiation is completed. Scenario outgrowths which grow out of a branch of initiating failure have scenario tree form. This is illustrated in figure 2.4 showed below. Scenario outgrowths depend on architecture of a system and events that occur after an initiating event; for instance, outgrowth can emanate as result of barrier system positioned in a system to catch exception after failure initiation is completed. Typical example is a watchdog barrier system that is purposely built to monitor and close off hydrocarbon flow in crude-oil production system. This kind of system prevents failure from occurring when it functions as desired and forces the system mechanism to undesired state, but benign end state. Two states of outgrowth from initiating events are benign end state (BES) and harmful end state (HES).

2.3.4 Principle of Unending Cause-Effect

Every scenario has infinite number of link which extends indefinitely in both directions; in other words, this principle indicates that traces of cause-effect chain extends in both directions provided system interaction and time-dependent function cover area and abut points of boundary of system interaction. For example, 'pipe break' as an initiating event for hydrocarbon leak could be end state of

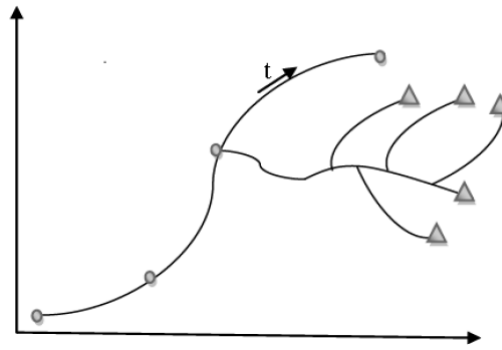

FIGURE 2.4: Scenario Tree Emanating from Initiating Event

initiating event ‘too much pressure or too much temperature in a pipe’. The cause-effect chain extends indefinitely in both directions.

This principle makes it certain that for every effect within an area or at boundary of system interaction, there is cause within or outside peripheral of the area of interaction. AFD and other RA methods embody this principle.

2.3.5 Principle of Subdivision

Every scenario that can be described with a finite set of words is itself a set of scenarios; a scenario can be broken down into sub-scenarios. For example, scenario “pipe break” can be broken down into “axial break,” “transverse break,” “punctures,” and et cetera. Each type of pipe break is scenario itself because they have distinct roots causes; for instance, ‘axial break’ has its root causes as well as transverse breaks.

2.3.6 Pinch Point Principles

A scenario tree may have what is called pinch point which is a point at which two points from upstream area of scenario tree meet. This principle states that a pinch point is dependent on points that are located at upstream area of system and subsequent points in the downstream area are dependent on pinch points. In very concise and comprehensive form, this principles states that scenarios that occurred in downstream are caused by what happened in upstream, but scenarios that emerged in upstream depend on scenarios that occurred before them.

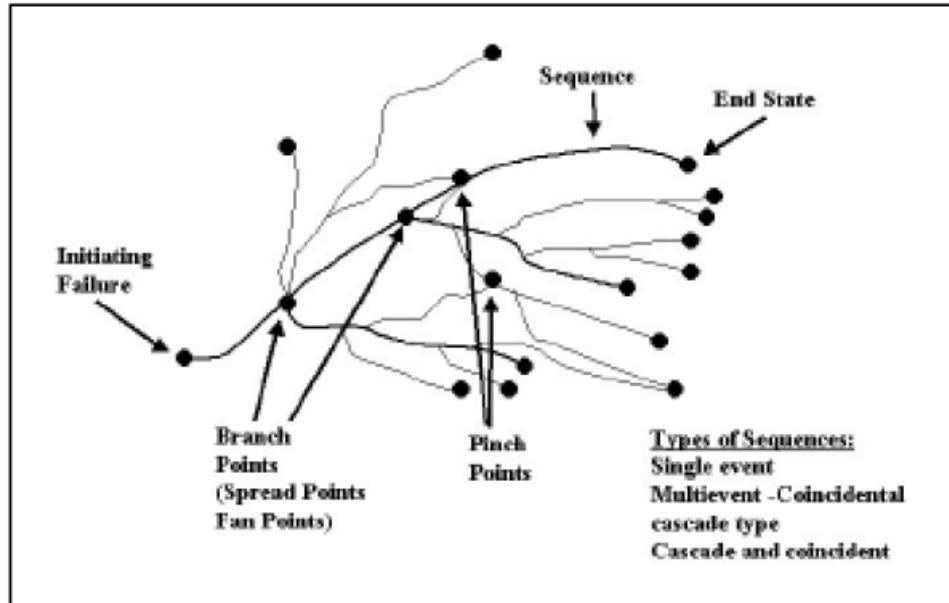

FIGURE 2.5: Pinch Point in Scenario Tree [1]

2.3.7 principle of Resources

A system usually comprises subsystems which require resources to deliver their outputs; in this case, resources that are required by system to deliver its function can be called system promoting resources. As well, system has resources which inhibit its function. The word ‘inhibit’ in this sense refers to resources that contribute to system failure or stops a system from reaching its success scenario, S_0 . This kind of resources that can stop a system from reaching success scenario, S_0 , can be called system inhibiting resources.

Principle of resource states that any initiating event can only occur if and only if inhibiting resources for producing that failure are in a system or within an environment. Conversely, initiating event cannot occur if any resource is missing. There must be complete number of inhibiting resources in vicinity of or within a system for a failure to occur. This is one of TRIZ principles, which is explained in chapter 1

2.4 Methods of Revealing Scenarios

Principle of scenario structuring supports forward process and backward process of creating end states. The flexibility of moving forward and backward in attempt to produce end states is source of strength of RA methods. Backward process and forward process of creating end states can be can be illustrated in following method of revealing of scenarios:

- *Forward process: identify all possible initiating events by paying attention to each phase or subsystems and draw outgrowing tree from initiating events to their end states.*
- *Backward process and forward process: identify crucial end states and draw incoming and outgoing tree to each by applying the principle of unending cause-effect.*
- *Backward process and forward Process: identify possible mid states (pinch points) by focusing on inhibiting resources within and around a system and draw incoming tree and outgoing tree to each.*

2.4.1 Failure Mode and Effect Analysis (FMEA)

Failure mode and effect analysis uses forward method of identifying scenario, which is identifying initiating events by focusing on phases and subsystems. In the method, forward process is applied by assuming that $n - 1$ components are functioning as desired with exception of one component. An end state is registered which reflects failure of the component that is not functioning. This process is repeated for n number of components in a system until n number of end states is obtained. FMECA is often applied in electronics and aerospace manufacturing industries because it reveals scenarios that can occur when a component of machine fails which helps in building resilient systems or barrier that can withstand and avert negative consequences. Practical approach of FMEA method is “working” through all components of a system and asking “what could happen if only a component were not working when remaining components were functioning as desired?” Repeatedly asking this question for each component of a system flushes out effects of component failures.

Although this method offer value to risk science, it does not satisfy requirements for revealing and identifying complete scenarios (effects) that can occur as result of component failures because system components are multitasked nowadays to meet need of efficiency. Multitasking system in present technology segments system function into a number of modes and phases of operation, which when integrated equates desired success scenario of a system.

In the case of multitasked system which its operation is segmented into phases, FMEA matrix method that takes into consideration total number of system components and phases of system operations is used for revealing completes effects of components failure on a system. The matrix method is showed below.

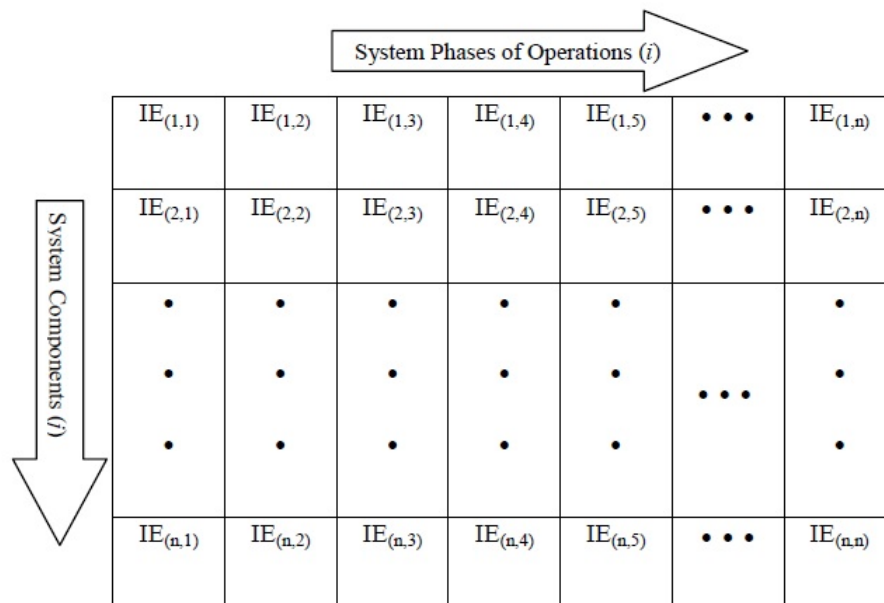

FIGURE 2.6: FMEA Matrix for Revealing Complete Scenarios [1]

Figure 2.6 reveals complete initiating events that can occur in multitasked system in which its success scenarios are segmented into phases of operations. For instance, taking out one initiating event from the matrix and performing forward process and backward process will yield complete scenarios for the initiating event. Repeating the forward and backward process will yield complete scenario of multitasked system.

2.4.2 Fault Tree Analysis (FTA)

Fault tree analysis, abbreviated as FTA in different literature, employs second method which is identifying crucial end states and drawing incoming and outgoing trees to each scenario by applying principle of unending cause-effect – forward process and backward process. In FTA analysis, simple way for finding group of scenarios that contribute to appearing of an end state is by selecting the end state and asking the question “How did the end state come about?” This question stimulates mind to think about scenarios that contribute to appearing of the end state. Repeatedly asking the question “How did an end state come about?” while working downwards from each end state establishes FTA network. Those points at which incoming and outgoing trees meet in the FTA network depicts relationship among scenarios and these relationships are then diagrammatically translated into diagram for vividness using logic gates.

2.4.3 Event Tree Analysis

Event tree analysis, abbreviated as ETA in literatures, uses the first method of revealing and identifying scenarios. An advantage of ETA is that it is mainly focused on a crucial path of outgrowths of scenarios and estimated probabilities which are used as basis of calculating probability of occurrence of end states using Bayesian theory. Also, this method applies indexing method of analysis because its approach centers on analyzing and calculating probability that a path in scenario tree can occur. EVT gives flexibility of assessing and calculating a metric values that indicates probability of reach an end state using Bayesian probability.

2.4.4 Hazard and Operability Analysis

Hazard and operability analysis, shortened as HAZOP in various scientific literatures, is mainly used to identify root causes of deviation from specification and negative consequence of deviation in downstream of a system network. When a system is designed, its components are designed in a way to deliver output to subsequent component depending on network structure of a system. Mainly, the delivered output can either be scalar or vector quantity which span from heat flux, light intensity, temperature and et cetera. HAZOP is methodically structured to

capture deviations of vector or scalar quantity between two nodes which is the reason why such scenarios are addressed as middle states or mid states per se.

In HAZOP approach, forward process and backward process are applied by identifying middle states and working through entire upstream to identify root causes and downstream to reveal consequences; for instance, typical HAZOP approach identifies mid states such as lower air flow, higher heat flux, higher air flow, lower heat flux in combustion chamber and work entire upstream and downstream of each mid state to establish scenario trees using forward process and backward process.

In HAZOP, matrix form can be used to extensively establish concept of finding complete scenarios, which are mid states. In this case, system success scenario, which is usually segmented into phases of operation, can be represented on horizontal part of matrix and system components can be placed on vertical part; this matrix representation provides flexibility to capture hidden scenarios which may not be too obvious because of multitasking.

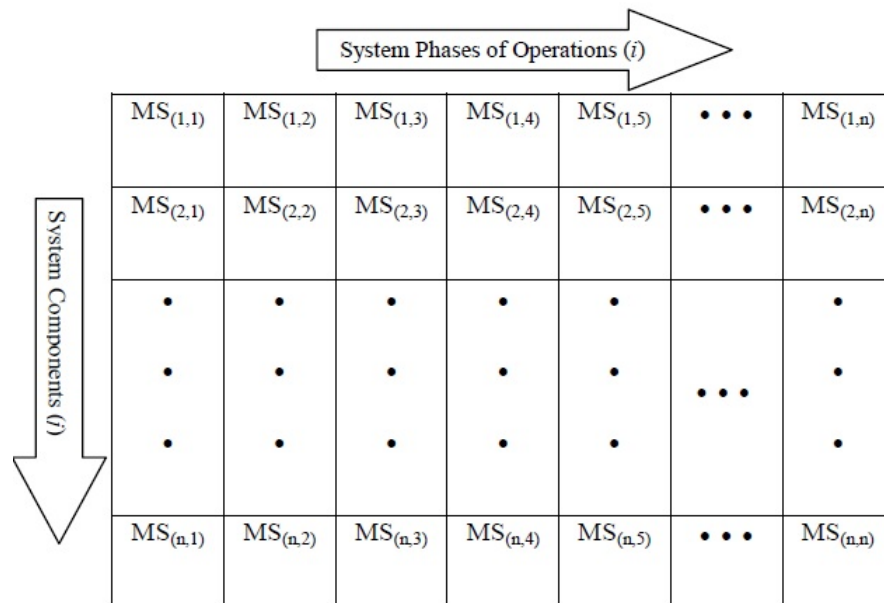

FIGURE 2.7: HAZOP Matrix Concept for Revealing Complete Scenarios

By system principle of operation, success scenario, S_0 , is reached if all phases are completed successfully; conversely, system success scenario cannot be reached if a mid state, $MS(i, j)$, appears in a phase which can signal failure at a phase. Finding complete scenarios requires taking each mid state of a phase, working upstream and

downstream to identify root causes and consequences of mid-states respectively, and drawing incoming and outgoing trees to mid states. The above illustrated approach shows way of finding complete scenarios, $\{S_i, L_i, C_i\}$, in multitasking system or multiphase operations using HAZOP.

2.4.5 Anticipatory Failure Determination Approach, AFD

Anticipatory failure determination, abbreviated as AFD, is a method which is based on theory of inventive problem solving and principle of resource, which are explained already in previous chapters. With respect to serving purposes of failure analysis and failure prediction, AFD is subdivided into two groups – AFD-1 and AFD-2. AFD-1 is structured for conducting failure analysis using theory of inventive problem solving and AFD-2 is structured for performing failure prediction with continual application of AFD-1 to reveal scenarios. These two versions of AFD offer great value to risk management as they provide mechanism through which failure scenario can be analyzed using forward method and backward method. This will become obvious as their templates are presented and discussed in the following.

2.4.6 I-TRIZ Based AFD-1 Template

This template embodies scheme of AFD thought-process cycle and solution by abstraction that are explained in chapter 1. Only difference between both is slight and negligible, which is AFD-thought process cycle is generic concept, but AFD-1 is methodically structured and specialized for failure analysis of a specific inventive problem. The template is as shown below.

STEP 1: FORMULATE ORIGINAL PROBLEM OF SYSTEM

In this step, state name of a system and its purpose (success scenario); describe a failure that occurred and describe condition that accompanied or in which the failure occurred. Formulating original problem refers to giving details about the failure that occurred without adding or removing any information; this means that every attribute of the failure must be stated as it is without bias. Attribute of failure is important to find and specialize solution to its inventive problem. For example, *C-fan* is a fan installed *to regulate temperature of electric cooker*,

which *released smokes that have smell of burned coil and stopped functioning* when *temperature of the cooker abnormally rose to 300 degree Celsius*. In the example, name of the system ‘C-fan’ and its purpose ‘*regulation of temperature of cooker*’ are stated. The failure ‘*released smokes that have smell of burned coil and stopped functioning*’ and condition in which the failure occurred ‘*when temperature of cooker rose to 300 degree Celsius*’ are also stated to formulate the problem.

STEP 2: IDENTIFY SYSTEM SUCCESS SCENARIO

In step two, *identify system success scenario and its phases (subsystem)*. Focus attention on its subsystem to ascertain functionality of its phases if the system is modular architecture. Following phase sequence of subsystems reveals mechanism of reaching success scenario. For example, success scenario of c-fan can be identified as thus

Subsystem	Success Scenario, S_0
cable wire	conducts voltage
<i>armature</i>	rotates blades
blades	breezing

STEP 3: LOCALIZE THE FAILURE

Localize the failure in this step; the simple trick to localize a failure in modular architecture is to apply FMEA method since the target is to identify a phase or subsystem in which the failure occurred. Using typical FMECA concept can flush out region of a failure. For example, using the failure description ‘*the fan released smokes that have smell of burned coil and stopped function when temperature of cooker abnormally rose to 300 degree Celsius*’, it becomes obvious that the region of the failure is ‘*armature*’ since this subsystem is made of coil.

Subsystem	Success Scenario, S_0
cable wire	conducts voltage
armature	rotates blades
blades	breezing

STEP 4: FORMULATE AND AMPLIFY THE FAILURE

Step 4.1: In this step, it is criterion to restate the problem in such a way that it reflects attributes of inventive problem. This step is same with first step of solution by abstraction. An example is given in chapter 1 using differential equation. Restating a problem to possess attributes of inventive problem is called problem inversion in AFD and problem that has inversion attributes is called inverted problem. Typical approach of inverting a problem is starting with sentence preamble such as '**it is important to produce**' or '**It is crucial to synthesize. . . .**' and ending the sentence with failure and condition that accompanied a failure. For example, the failure of c-fan can be stated as thus:

it is important to produce *release of smokes that have smell of burned coils prior to c-fan stopped functioning* **UNDER** *condition of 300 degree Celsius temperature of cooker.*

A problem that is restated in this way is called inverted problem because the way in which the problem is stated demands synthesizing a phenomenon of failure rather guess from physical features that characterize a failure. Other essential factors to recognize are resources. Having details about condition under which or accompanies a failure and phase at which a failure occurred can flush out required resources to produce phenomenon of a failure.

Step 4.2: amplify the inventive problem; amplification of inverted problem is crucial to ascertain that probability of producing a phenomenon under a specified condition with identified resources is close to unity, which signifies certainty. for example, instead of producing release of smoke with burned-copper smell in an area of c-fan armature, AFD approach suggests that the phenomenon of the failure must be produced on the entire area, space and volume of C-fan armature with identified resources under same condition that initiated the failure. Problem amplification is a way to ensure likelihood of unity value for revealed scenario. If a failure occurred rarely, the approach suggests producing its phenomenon "repeatedly" or "constantly."

STEP 5: SEARCH FOR SOLUTION

Fifth step suggests searching for solution to an inverted and amplified problem; such searching needs one to search various database for information on how to produce a phenomenon of a failure. This step is the same with step of mapping

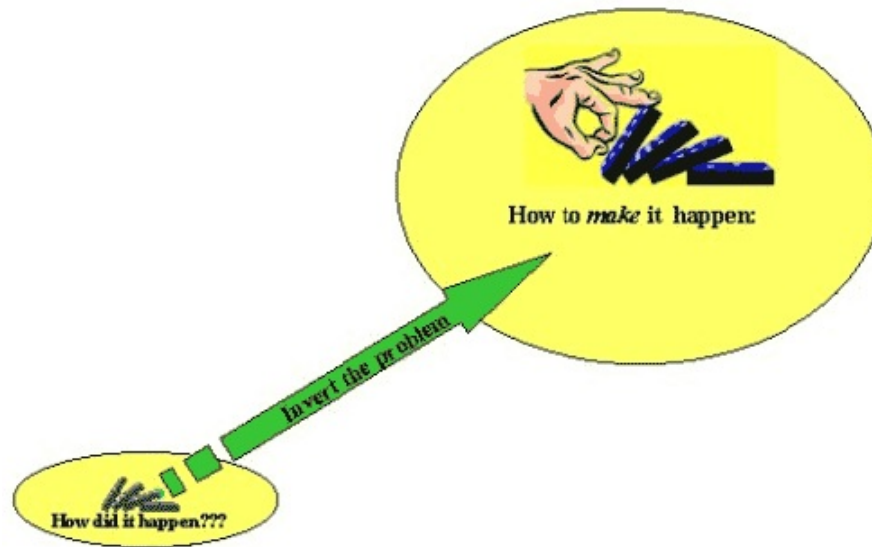

FIGURE 2.8: Changing a Problem to Inverted Problem [1]

problem abstract category to solution abstract category in the example ‘solution by abstract using differential equation’ in chapter 1. Typical example is illustrated in figure 2.9

STEP 5.1: Search for Obvious Solution

In step 5.1, search for any engineering field, science, or other endeavors in which same process of a failure is intentionally realized. This step is in compliance with Genrich Altshuller’s discovery that there are similar patterns of solution for similar problem. Principal target of this step is to identify method of synthesizing a phenomenon of failure.

STEP 5.2: Identify Resources

Producing a failure requires resources; this step suggests surveying and identifying resources. Resources can be identified by surveying resources that are used in an identified method of producing a failure phenomenon and checking for presence of those resources in vicinity or region at which a failure occurred. If resources of identified method are present in the system, it indicates that it is general solution to the inverted problem, which is a way to benchmark phenomenon of system failure with identified method of synthesizing the phenomenon. Reason for this benchmarking is due to fact that resources used to intentionally produce a phenomenon in an identified method can always be same with resources required to

produce a failure. Two conventional approaches to survey and identify resources are as thus:

- *Find required resources for producing a phenomenon in an identified method*
- *Check for presence of those resources identified in the method in a system of analysis*

In real practice, AFD has software package that can help in surveying and identifying resources. While benchmarking and surveying resources, a solution to an inverted problem may be flushed out by identified resources and method. If solution is not flushed out yet; then proceed to next step.

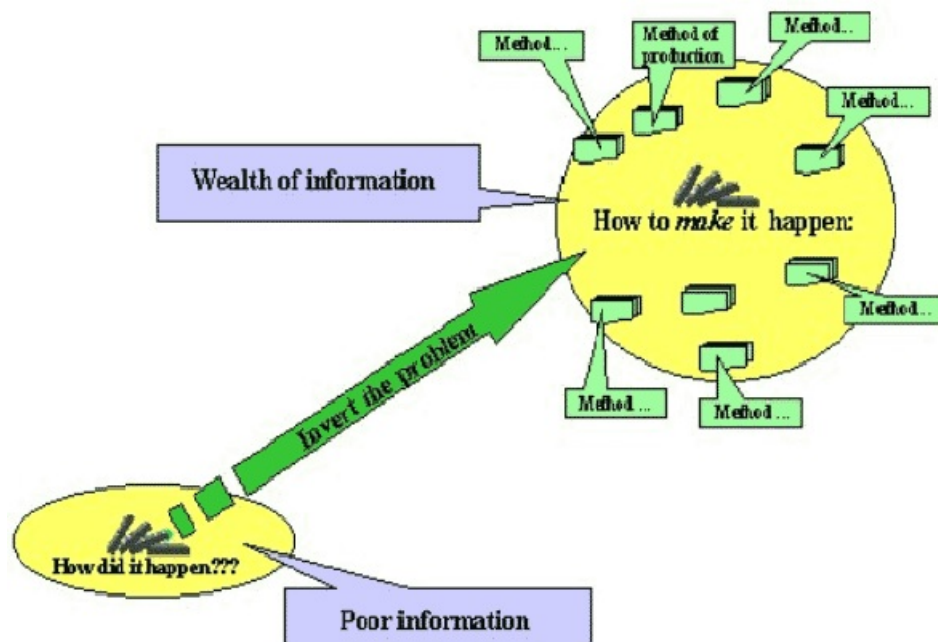

FIGURE 2.9: Process of Searching in AFD [1]

Step 5.3: Searching for the Failure Effect Using Available Resources

Because principle of resources states that resources that contribute to appearing of an undesired event must be present within or around a system for an event to occur, there must be one or more latent resource(s), which can be found in peripheral of a system. In this step, find most latent resource in category of physical effect, chemical effect, or biological effect around or within the system which in combination with most obvious resources can yield the phenomenon. AFD software package can help in finding latent resources since it has I-TRIZ innovation

software specialized for this purpose. If this step does not yield, solution, it shows there are contradictions. Proceed to next step and apply ARIZ.

Step 5.4: Apply ARIZ, Algorithm for Inventing Problem Solving

In this step, reapply the I-TRIZ method by focusing on physical, chemical, biological or technical contraction that exist between what you have as result and what you want to produce with respect to resources within or around the system because after applying step 5.1, 5.2, and 5.3 of AFD-1 template, resources which are needed to synthesize the failure event should have been revealed; but contradiction may exist on how to realize the effect with available resources. This is where ARIZ application comes in. The methodical approach of ARIZ is shown in the below depicted flow chart.

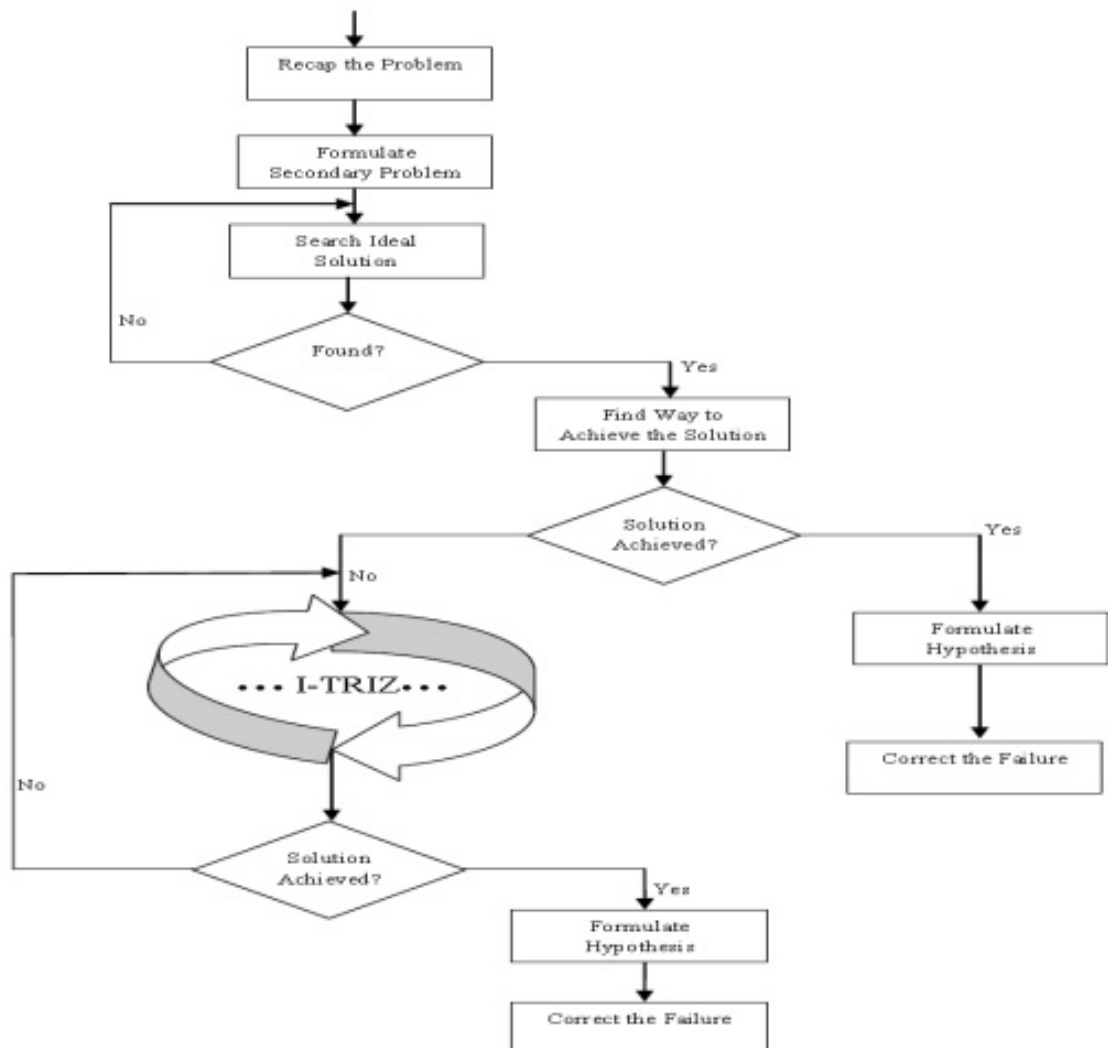

FIGURE 2.10: Flow Chart for Algorithm of Inventive Problem Solving

The figure 2.10 illustrates flow chart of methodical process of applying ARIZ to solving secondary problem, tertiary problem or n^{th} problem until solution is found. Practically, ARIZ is recurrent approach of repetitively applying I-TRIZ for producing a phenomenon. As showed in the figure 2.10, simple approach of I-TRIZ is formulate a problem, identify a method by searching solution from repositories of information, and synthesize a phenomenon with respect to identified method using resources around a system. The first five steps of the flow chart is typically I-TRIZ method beside the step, recap the problem. ARIZ method for AFD comprises these steps:

- *Recap a problem*
- *Formulate secondary problem*
- *Formulate Ideal solution of the problem*
- *Search ways to achieve the solution*

If the first the solution is completely solved, it means there is a latent resources that should be found; then, formulate tertiary problem and continue in the loop until solution is revealed.

STEP 6: HYPPTHEESIZE THE SOLUTION AND VERIFY IT

In step 6, hypothesis of how a failure (problem) occurs is formulated and systematic approach on how to prove validity of the hypothesis are stated and proved.

Step 7: CORRECT THE FAILURE

Present remedies for preventing or eliminating failure. Principle of maximum use of resources is applicable here to correct a failure.

2.4.7 I-TRIZ Based AFD-2 Template

AFD-2 is failure prediction analysis. This method embodies framework that is very important in safety system design as it shows forward method and backward method of predicting all possible failures of a system before they occur, which is crucial for preventing them before they impact damages. This method is recurrent application of AFD-1 concepts. Its template is shown in the following.

STEP 1: FORMULATE THE PROBLEM

In this step, formulate the problem, which can be stated as: predicting all possible system failures and synthesizing the predicted failures. Importance of focusing on predicting all possible system failures and synthesis those failures as original problem in AFD-2 approach is due to necessity to predict them, synthesize them, understand their mechanisms and prevent them before they occur.

STEP 2: DESCRIBE THE SYSTEM SUCCESS SCENARIO, S_0

Describe system phases, success scenarios of its phases $\{S_{p1}, S_{p2}, S_{p3}, \dots, S_{pn}\}$, and success scenario of the system, S_0 . This is similar to step 2 of AFD-1.

STEP 3: FORMULATE THE INVERTED PROBLEM

In this step, invert the problem as in AFD-1 template; in AFD-2, the inverted problem should read as thus: *“synthesizing all the possible failures that can appear as result of the system interactions.”*

STEP 4: FIND OBVIOUS IE, ES, and MS

Find obvious initiating events, harmful end states and mid states of the system by applying concept of FMEA and HAZOP; applying the two RA methods reveals most obvious initiating events $\{IE_j\}$, mid-states $\{MS_j\}$ and harmful end states $\{HES_j\}$; organize those $\{IE_j\}$, $\{MS_j\}$, and $\{HES_j\}$ in scenario trees for clarity.

STEP 5: FIND OR LOOK FOR LATENT FAILURES

Conduct survey of resources around and within the system and map out possible resources that can cause system failures; then, find latent or unobvious failure scenario by focusing on failure mechanism that can be initiated by those resources. AFD software can help in conducting such survey because it has package specialized for that.

STEP 6: STUDY AFD CHECKLIST

In step seven, AFD-2 approach suggests studying checklists, which are embedded in AFD software for possibility of finding scenarios. The scenarios that are found in this step should be added to scenario tree. The AFD checklists are appended for references.

STEP 7: DRAW INCOMING TREES TO END STATES

Seventh step of AFD-2 template demands that you draw incoming trees to connect the found initiating events, mid states, and end states, which is helpful for building scenarios through which harmful end states can occur. Since AFD-2 purpose is to find all possible failures and scenarios, try to identify other ways through which the found events can occur; in this case, AFD software and ARIZ are good supports for identifying other scenarios. In this step, worsen the harmful end states to whether other scenarios can result from that. If some scenarios result from worsening the HES's, draw incoming trees to account for them in the scenario trees.

STEP 8: STATE CORRECTIVE MEASURES

In this step, use I-TRIZ operators to recommend measure.

Chapter 3

Shortcomings of AFD Method

So far, AFD methods have been presented except shortcomings that are inherited when they are used to perform risk analysis. This chapter is dedicated to discussion of AFD shortcomings and reasons why they occur in any risk analysis in which the methods are used. Although there is no doubt that AFD method is better than other RA methods because of its embodiment of TRIZ principle, forward method, and backward method of searching scenarios in a system, it lacks frameworks to address factors that are technically important such as system interactions, modularity and integrality concept in system engineering, axiomatic design, and vulnerability analysis. Shortcomings that emerge because of preemissions of such technically important factors in AFD method are discussed in the following.

3.1 Omission of System Interactions

A system comprises a group of interrelated, interacting or interdependent subsystems which are functioning and transferring information, scalar or vector quantities among themselves to deliver a goal. In system engineering, a goal which a system is designed to deliver determines its layers, architecture, and structure. This is the reason some systems have one level form-form connections among their constituents and others have more than one level form-form connections. In practical sense, system form-form connection not only defines its operational mechanism and failure mechanism, but it reflects function-form relationship, which makes it

good basis for modeling and identifying what can go. As such, it is very important to use system interactions as basis of modeling and identifying failures.

AFD methods are structured with assumption that a system has only one layer of form-form dependency. Although this may be true for very few systems, it is not reliable concept for many systems in use today. As systems are getting more complex due to technical constraints, many systems have two or more layers which their interactions cannot be captured by searching failures at phase level. In AFD methods, search for failure sources is on first level of form-form dependency which can be thought of as subsystem-subsystem layer, but the methods lack framework to trace failure to lowest layers. For example, the two methods (AFD-1 and AFD-2) highlight the need to state phases, success scenario and trace failure at the phase level, but it is inaccurate from system engineering concept of modeling because a failure that emerges at first layer (subsystem level) may be caused by failure in a different layer of subsystem. It is more technically good practice to trace failure to lowest layer of system architecture which is way to take function-form dependency as well as form-form dependency into consideration.

In system engineering, a module is an independent chunk that is highly coupled within, but only loosely coupled to the rest of the system. Present AFD templates can only reveal what goes wrong in a loosely coupled part of a system (first level of form-form dependency), but the templates lack frameworks to reveal what goes wrong in highly coupled part of a system.

3.1.1 Remedy for Omission of System Interactions

This shortcomings due to neglect of system interactions can be eliminated by paradigm shift. The two methods must be modified to accommodate failure analysis to the lowest layer through embedding system engineering tools such as design structure matrix (DSM) in the methods to take system interactions into consideration while performing risk analysis.

3.2 Neglect of System Integrality

Century ago, complex system design was driven by business constraints because system designers were focused on designing system that would be easier to decompose for easy maintenance and design reuse. To achieve these purposes, many systems were built with respect to design axioms which suggest decoupling a system, but system decoupling is not totally practicable today. Today's complex systems design is as much integrated as they are modularized because design is driven by technical constraints and business constraints. This is supported by research that was conducted by Sosa et al and Katja Hölttä-Otto. This emergence of system integrality is due to demand for mass efficient, power efficient or fuel efficient systems, which are rather technical constraints. These technical constraints have made complex system possessed some degree of integrality as well as modularity. Many scientific researchers have been intrigued to research and come up with convincing evidences and models that back this postulation [2].

3.2.1 Modularity and Integrality

Sosa et al published interesting article on the need to ascertain whether a system is integral or modular as it has great impact on interactions. In her published paper, Sosa showed a method to identity whether complex system is modular or integral using design structure matrix (DSM). In further research, Katja Hölttä-Otto researched and showed model for computing degree of system modularity using DMS matrix to capture interactions in three ideal systems: fully modular system, bus-modular system and integral system. The proposed mathematical model is called Singular Modularity Index (SMI) in her published paper [2].

3.2.2 Singular Modularity Index

Katja Hölttä-Otto quantified modularity of complex system using design structure matrix to captures form-form dependency among components of ideal systems such as fully modular system, bus-modular system, and fully integrative system. She equated physical connections between two components such as contact zone, energy flows, material flows, information flows and it commonalities with binary digit '1' and non-contact between two components with binary digits zero '0';

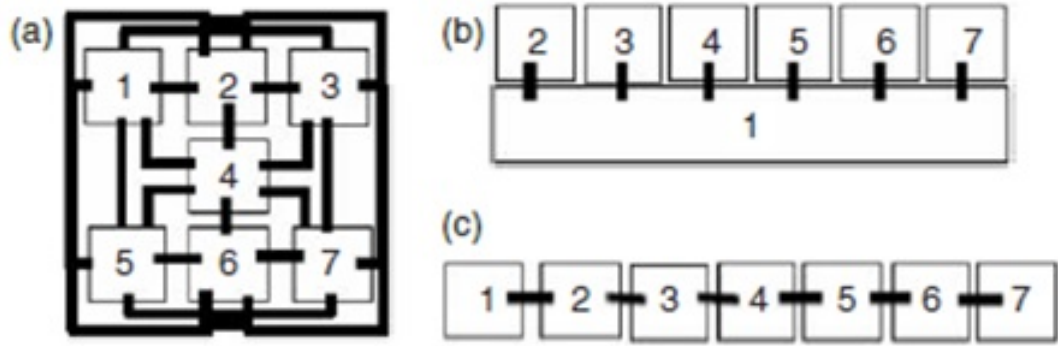

FIGURE 3.1: (a)Integral System (b) Bus-Modular System (c) Modular System [2].

thus, obtaining matrixes of 7-by-7 order as each of the ideal systems have seven components in its architecture. They performed singular value decompositions on the three matrixes of those ideal systems and calculated singular values. The singular values according to Katja Holttä are equal to square root of eigenvalues of $DSM^T DSM$ [2].

$$DSM_a = \begin{bmatrix} 0 & 1 & 1 & 1 & 1 & 1 & 1 \\ 1 & 0 & 1 & 1 & 1 & 1 & 1 \\ 1 & 1 & 0 & 1 & 1 & 1 & 1 \\ 1 & 1 & 1 & 0 & 1 & 1 & 1 \\ 1 & 1 & 1 & 1 & 0 & 1 & 1 \\ 1 & 1 & 1 & 1 & 1 & 0 & 1 \\ 1 & 1 & 1 & 1 & 1 & 1 & 0 \end{bmatrix} \quad DSM_b = \begin{bmatrix} 0 & 1 & 1 & 1 & 1 & 1 & 1 \\ 1 & 0 & 0 & 0 & 0 & 0 & 0 \\ 1 & 0 & 0 & 0 & 0 & 0 & 0 \\ 1 & 0 & 0 & 0 & 0 & 0 & 0 \\ 1 & 0 & 0 & 0 & 0 & 0 & 0 \\ 1 & 0 & 0 & 0 & 0 & 0 & 0 \\ 1 & 0 & 0 & 0 & 0 & 0 & 0 \end{bmatrix}$$

$$DSM_c = \begin{bmatrix} 0 & 1 & 0 & 0 & 0 & 0 & 0 \\ 1 & 0 & 1 & 0 & 0 & 0 & 0 \\ 0 & 1 & 0 & 1 & 0 & 0 & 0 \\ 0 & 0 & 1 & 0 & 1 & 0 & 0 \\ 0 & 0 & 0 & 1 & 0 & 1 & 0 \\ 0 & 0 & 0 & 0 & 1 & 0 & 1 \\ 0 & 0 & 0 & 0 & 0 & 1 & 0 \end{bmatrix}$$

In attempt to observe distinct form-form attributes of systems, Katja Hölttä-Otto sorted singular values in ascending order, normalized them with maximum singular values and was able to come up with the model for calculating modularity. Using the SMI model and nonzero fraction (NZF), she was able to categorize system

into modularity and integrality, which is convincing evidence that today's complex systems share characteristics of modular system as well as integral system.

$$SMI = \frac{1}{N} \arg \min_{\Phi} \sum_{i=1}^N \left| \frac{\alpha_i}{\alpha_1} - \exp^{\frac{1-i}{\Phi}} \right| \quad (3.1)$$

$$NZF = \sum_{i=1}^N \sum_{j=1}^N \frac{DSM_{(i,j)}}{N(N-1)} \quad (3.2)$$

NZF model is used to calculate how connection within a chunk sparsely distributed within a chunk. In her result depicted in figure 15, she demonstrated that jet engine (9), MR injector (11), CT injector (5) and powertrain (14) have higher degree of integrality than modularity, which indicates that complex system is not fully modular as AFD approach assumes

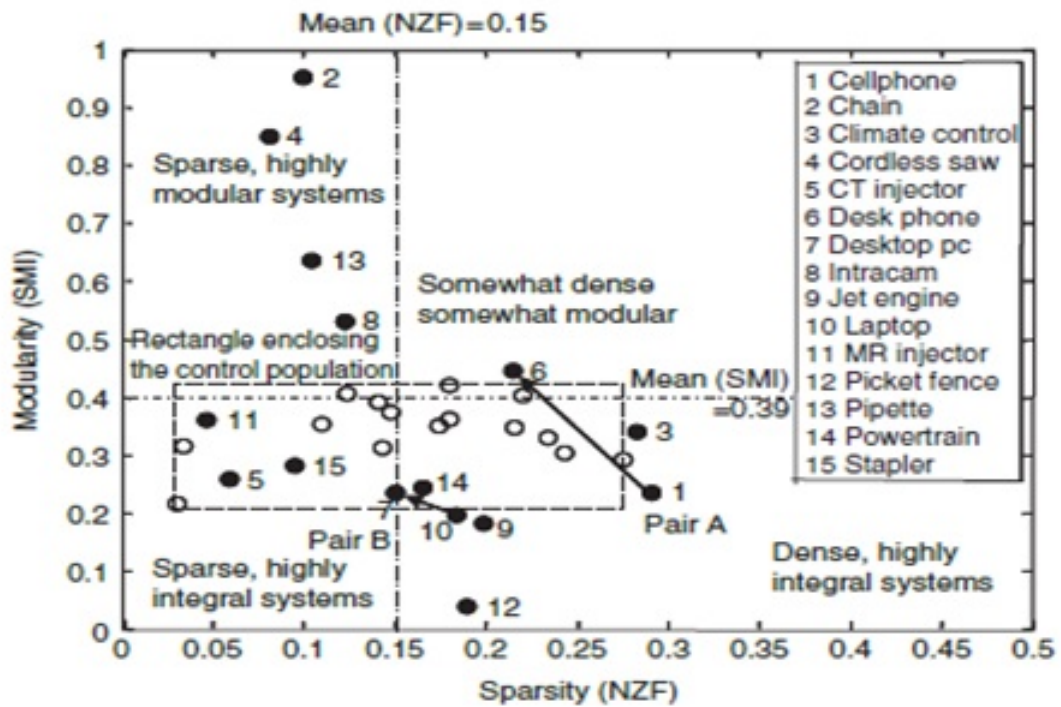

FIGURE 3.2: Graph of Modularity Verses Sparsity for 15 Products [2].

With respect to SMI model, higher degree of integrality means that components are more highly coupled than loosely coupled in today's complex system. In other words, there are more densely interconnections among components of complex

system. In this case, Hölttä-Otto's model and results are good basis to address neglect of integrality in AFD methods.

3.2.3 Remedy for Neglect of System Integrality

Many functions are allocated to a component in integral system, but one function is allocated to a component in modular system. Components are densely connected in different layers in integral system, but components are highly coupled in chunks (modules) and chunks are loosely coupled at subsystem level. As such, imbedding DSM in AFD methods is technically proficient to take integrality as well as modularity into consideration while using AFD method to perform RA analysis.

3.3 Pretermission of Vulnerability Analysis

Vulnerability analysis is degree of responsiveness of system and its constituents to natural system around them. Vulnerability occurs because of interactions between natural system and artificial system. Natural system is system which we cannot dictate – it is the system we live in. Artificial system is manmade system designed with respect to law of nature to deliver expected output; for example, automobile is designed for conveying people from one place to another by establishing design tradeoff between friction verse engine power; ship is designed to transport goods and people from one place to another by establishing tradeoff between weight verses buoyant force and current verses engine power. System engineering design has always been about designing man-made system to function with natural system; this is evident in axiomatic design principles.

In engineering design, synergy is a major challenge. Synergy is very difficult to address during system design because of complex interactions between artificial systems with natural system. This problem is evident in common engineering quotes “summation of parts in a system is less than system behavior.” This system property is called emergent behavior. Such behavior is emergent because it is unexpected since it is not taken into consideration during design. This is another problem which AFD is not structured to capture.

AFD is potent RA method that has potential to reveal a number of system failures due to emergent behavior, but it is not methodically structured to cover total spectrum of risk analysis since its framework lacks vulnerability analysis. For example, AFD approach neglects subsystem architecture and component vulnerabilities, but directs analyst's thinking on failures of subsystems. This present paradigm of AFD approach neglects responsiveness of components to physical processes around them. This neglect is due to assumption in AFD that system comprises only first level form-form interconnection as it treats subsystems elemental component of a system. This paradigm on which AFD methods are based has potential of springing up surprises that will be very damaging. For example, let's suppose figure 3.4 is architecture of a system.

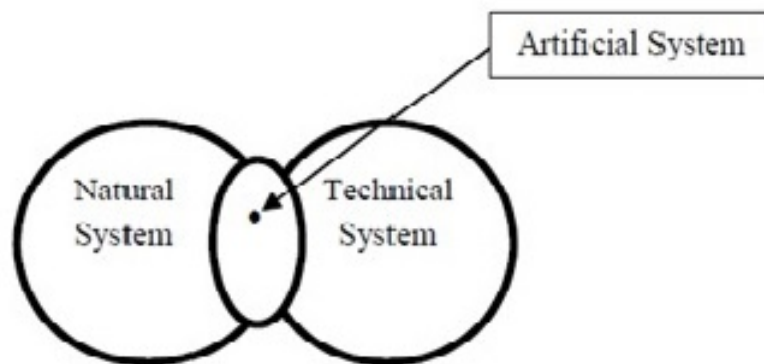

FIGURE 3.3: Engineering Concept of Product Design

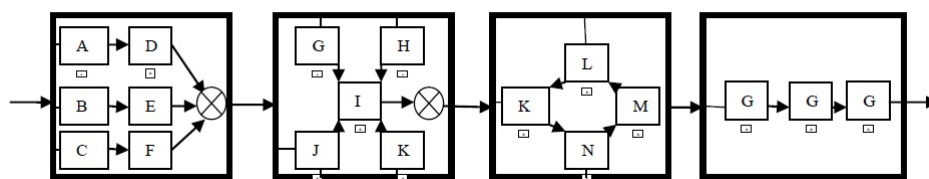

FIGURE 3.4: Example of System Architecture

Typical AFD approach focuses analysis on chunks which are big, thick black boxes as in figure 17, but neglects interconnected components in chunks and physical processes which take place in them. This paradigm of focusing analysis on chunks while neglecting internal structure, interconnected components, and physical processes that take place in chunks can only capture scenarios that take place outside chunks and reveal scenario tree as depicted in figure 3.5, which is deficient of scenarios that emanate from interconnected components and physical processes

encapsulated in chunks. A sophisticated AFD method must reveal complete scenarios as illustrated in figure 3.6.

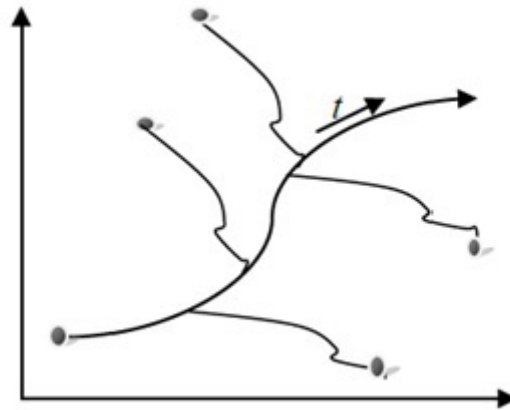

FIGURE 3.5: Basic Scenario Tree of Figure 3.4 Using AFD Approach

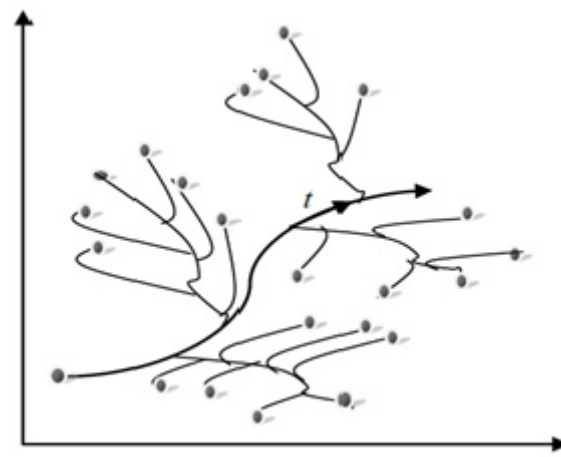

FIGURE 3.6: Scenario Tree of Figure 3.4 Considering all Parts

3.3.1 Remedy for Pretermission of Vulnerability Analysis

A system comprises arrayed, interconnected components at its different levels of form-form connection, so it practically technically sufficient to imbed vulnerability analysis in AFD methods. Vulnerability analysis must take holistic approach and consider these:

- *Multiple interacting physical processes (perturbation, stress or stressor) and chain or sequence of their interactions,*

- *Responsiveness of components and subsystem when exposed to perturbation or stressor and effects of exposure,*
- *The sensitivity and resilience of a system and its parts to physical processes (natural system),*
- *Checking for differential vulnerability because components and subsystems are not equally vulnerable to physical processes,*
- *Check for stochastic and non-linear elements within or outside a system, which could spring surprises, and*
- *Connect cause-effect links in scenario tree.*

3.4 Neglect of Axiomatic Design Framework

Axiomatic design framework is framework of managing knowledge of system interactions from design phase through its life cycle. This framework of managing knowledge of system interactions is created by mapping Design matrix of axiomatic design (DM) to design structure matrix (DSM) to combine strengths of both tools in order to eliminate difficulty and avoid subjective way of managing knowledge of system interactions during system design. In system engineering, DM is used to capture interactions among functional requirements (FR's) and design parameters (DP's). DSM is used to capture interactions among components of a system. Transformation is used to map information from DM to DSM to link knowledge and design decision made during design with component interactions. Mapping of DM to DSM provides linkages among functional requirements, design parameters, manufacturing processes, products and its components, which provide basis to trace failure from a component through manufacturing process and design phase.

AFD is weak approach when problem of risk analysis is concerned with revealing failures due to human errors and bad ergonomic design; this AFD weakness is due to lack of system knowledge management framework in AFD approach, which can link system unintended behavior and attributes to manufacturing process and design parameters. These linkages among the four domains provides basis to identify a failure in one domain and trace its root causes in other domains since an organized methodology is employed in industry, which encompasses translating

customer requirements to functional requirements, mapping functional requirements to design parameters, and mapping design parameter to process variables in order to manufacture a product. This methodology of design is often carried out using design matrix of axiomatic design (DM), quality function deployment (QFD), and design structure matrix (DSM).

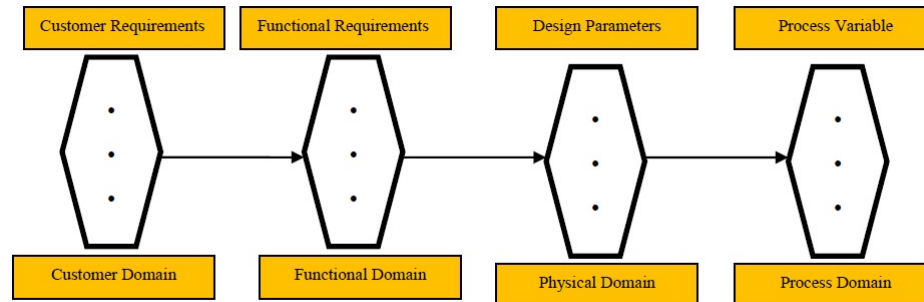

FIGURE 3.7: Axiomatic Design Framework

The QFD is applicable to the first phase of axiomatic design framework to translate customers' needs to functional requirements. Design matrix of axiomatic design is used to map functional requirements to the physical domain while considering relationships between functional requirements and design parameters. By zigzagging thought process of design, functional requirements and design parameters are equally split in number, so that row and column of DM matrix must be equal. According to axiomatic design, functional requirements are independent set of requirements that characterize product needs; design parameters are parameters that characterize design that meets functional requirements; process variables are manufacturing processes by which a design parameter are created. The relationships between two domains can be captured in matrix and map from one domain to the other using transformation method. In axiomatic design framework, mapping from one domain to another carries history of organizational decisions, technical decision, processes which are applied during design and creation of a product.

	DP_1	DP_2	DP_3	DP_4
FR_1	X	O	O	O
FR_2	X	X	O	O
FR_3	X	X	X	O
FR_4	X	X	X	X

	DP_1	DP_2	DP_3	DP_4
FR_1	X	O	O	O
FR_2	O	X	O	O
FR_3	O	O	X	O
FR_4	O	O	O	X

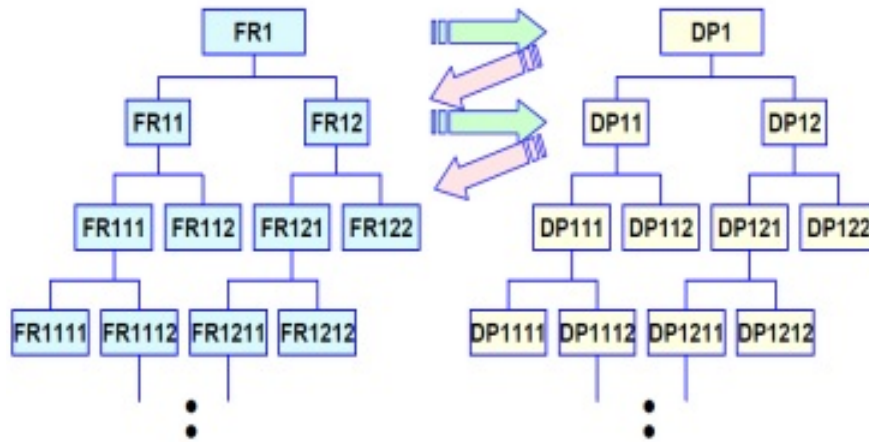

FIGURE 3.8: Zigzagging Process of Decomposing FR to DP [5]

As illustrated in the two tables above, relationships between functional requirements (FR's) and design parameters (DP'S) can be captured using DM. The boxes which are marked with letter 'X' show relationship between FR's and DP's and the boxes that are marked with 'O' show that FR's does not have relationship with DP's. This is typical guide of complex system design that is supported by design axioms, which can be thought as register for storing relationships between DP's and FR's.

Feasibility of using axiomatic design framework as means of revealing failures is due to possibility of transforming information captured by DM to DSM which provides basis to identify problem and trace its root causes in any of the linked domain in framework for managing system knowledge, since DSM serves as repository for storing and assessing knowledge of system interactions . Clear thinking that supports proposition of axiomatic design framework as a means through which AFD methods can be empowered to identify human error and reveal its scenario is because the knowledge management framework can store system interaction, management decisions, technical decision, and technical processes which are taken

during manufacturing a product. For example, figure 3.9 shows possibility of tracing product failure in any of the four domains by mapping information from DM to DSM or vice versa [6].

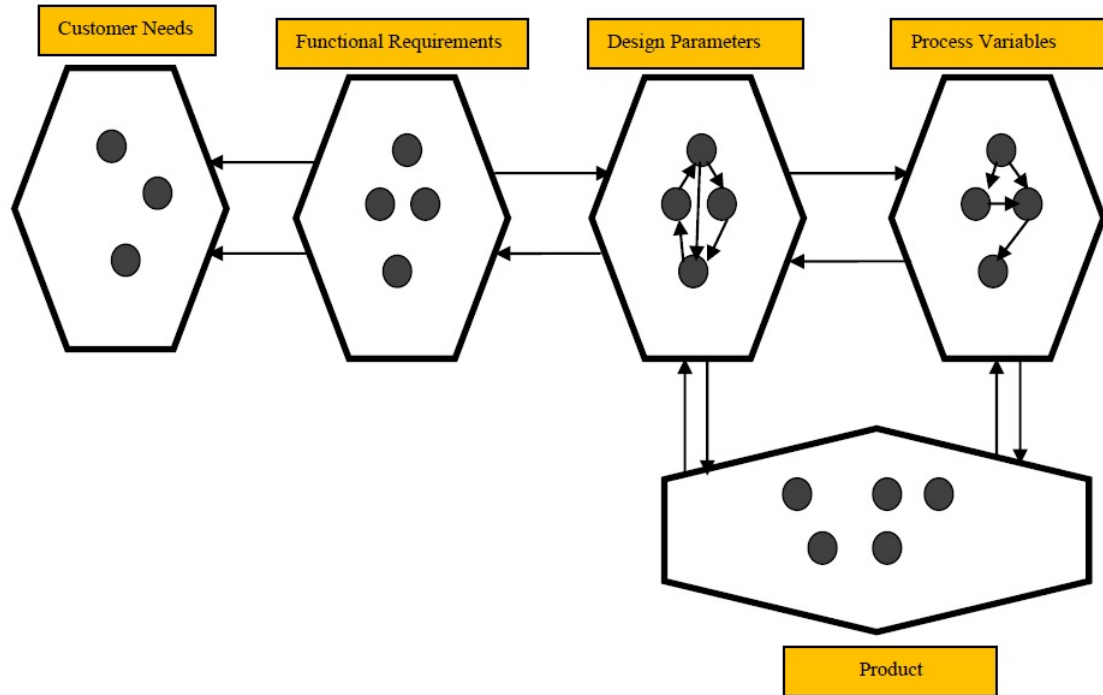

FIGURE 3.9: Framework for Managing System Knowledge [6]

3.4.1 Transformation of DM to DSM

Transformation of axiomatic DM to DSM provides basis and means to analyze a system, identify source of design problem, and trace through design domain or process domain to pinpoint source at which a failure emanates, which is important to address system emergent behavior. Boeing 787 is typical example to illustrate strength of basis provides by mapping DM information to DSM. Boeing 787 developed electrical problem after being manufactured, assembled, and delivered. In aviation industries, people were expecting Boeing to respond fast, but Boeing was unable to give out any information pertaining to the problem because they could not identify the source of the problem. This kind of difficulty can be averted by maintaining and managing knowledge of system interactions appropriately and linking them with risk analysis method. In this kind of problem, DM transformation to DSM will provide analysts with compact framework and knowledge base

of system interactions with which source of a problem can be spotted and trace through the five domains of framework for managing system knowledge [6].

The transformation method stems from power of substitution method in solving system of linear equation [6]. It is obvious that expressing a variable in terms of other variables in a function while solving system of linear equations reveals relationship among variables; for example:

$$8y = 10x + 9 \quad (3.3)$$

$$10y = 7x + 19 \quad (3.4)$$

Expressing x variable in terms of y variables still retains relationships between x and y . This is simple basis upon which transformation of axiomatic DM to DSM is based since DM possesses attributes of system of linear equations as showed in axiomatic design principles.

$$x = \frac{8y - 9}{10} \quad (3.5)$$

$$x = \frac{10y - 19}{7} \quad (3.6)$$

3.4.2 Essential Step to Transforming DM to DSM

As mentioned earlier, design matrix of axiomatic design (DM) has characteristics of system of linear equations, which in this case, describe relationships among functional requirements and design parameters; for example, 4-by-4-order matrix showed below can be used as an example.

$$FR_1 = \alpha_{1,1}DP_1 + \alpha_{1,3}DP_3 + \alpha_{1,4}DP_4 \quad (3.7)$$

$$FR_2 = \alpha_{2,1}DP_1 + \alpha_{2,2}DP_2 + \alpha_{2,4}DP_4 \quad (3.8)$$

$$FR_3 = \alpha_{3,1}DP_1 + \alpha_{3,2}DP_2 + \alpha_{3,3}DP_3 \quad (3.9)$$

$$FR_4 = \alpha_{4,2}DP_2 + \alpha_{4,3}DP_3 + \alpha_{4,4}DP_4 \quad (3.10)$$

Matrix – in – SLE – Form

	DP_1	DP_2	DP_3	DP_4
FR_1	$\alpha_{1,1}$	0	$\alpha_{1,3}$	$\alpha_{1,4}$
FR_2	$\alpha_{2,1}$	$\alpha_{2,2}$	0	$\alpha_{2,4}$
FR_3	$\alpha_{3,1}$	$\alpha_{3,2}$	$\alpha_{3,1}$	0
FR_4	0	$\alpha_{4,2}$	$\alpha_{4,3}$	$\alpha_{4,4}$

Matrix – in – DM – Form

	DP_1	DP_2	DP_3	DP_4
FR_1	X	O	X	X
FR_2	X	X	O	X
FR_3	X	X	X	O
FR_4	O	X	X	X

First Step: create a DM matrix of a system; for example, DM matrix of system of linear equations showed above is used.

	DP_1	DP_2	DP_3	DP_4
FR_1	X	O	X	X
FR_2	X	X	O	X
FR_3	X	X	X	O
FR_4	O	X	X	X

Second Step: choose output variables in the matrix such that only one chosen output variable will occupy one row and column of the matrix; for example the output variables of the DM matrix are chosen as shown below. the X s in rectangular boxes are chosen output variables.

	DP_1	DP_2	DP_3	DP_4
FR_1	X	O	\boxed{X}	X
FR_2	X	\boxed{X}	O	X
FR_3	\boxed{X}	X	X	O
FR_4	O	X	X	\boxed{X}

Third Step: For every DM matrix with chosen output variables, there is unique permutation matrix. Permute the rows of DM matrix in such a way that the output variables occupy the diagonal of the matrix. The matrix obtained after permuting DM matrix is DSM matrix; for example, the permutation matrix of the DM matrix is:

$$Permutation_{matrix} = \begin{bmatrix} 0 & 0 & 1 & 0 \\ 0 & 1 & 0 & 0 \\ 1 & 0 & 0 & 0 \\ 0 & 0 & 0 & 1 \end{bmatrix}$$

	DP_1	DP_2	DP_3	DP_4
FR_1	X	O	\boxed{X}	X
FR_2	X	\boxed{X}	O	X
FR_3	\boxed{X}	X	X	O
FR_4	O	X	X	\boxed{X}

The product of the permutation matrix and DM matrix is DSM matrix: row permute the DM matrix by multiplying columns of DM matrix with rows of permutation matrix as shown in equation 3.11

$$DSM = Permutation_{matrix} \cdot DM \quad (3.11)$$

Transformaton method is started with DM matrix (FRs vs DPs) and ended with DSM matrix (DPs vs DPs).

	DP_1	DP_2	DP_3	DP_4
DP_1	\boxed{X}	X	X	O
DP_2	X	\boxed{X}	O	X
DP_3	X	O	\boxed{X}	X
DP_4	O	X	X	\boxed{X}

Transformation of the matrix from axiomatic DM (FRs versus DPs) to DSM (DPs versus DPs) provides knowledge base for analyzing interactions among design parameters and interactions among functional requirements. Since DSM is repository of system behaviors, the value of this transformation method is that it offers flexibility of employing DSM which is suitable for analyzing and spotting design failure in a system

3.4.3 Remedy for AFD Weakness to Human Failures

AFD methods do not have capability to trace failure from product emergent behavior to manufacturing process variables, which is the reason its methods are weak in identifying and revealing failure due to human errors and bad ergonomic designs. The only means through which such capability can be created in AFD is imbedding DM and DSM matrix which their information can be mapped from one to the other.

Chapter 4

SIVAI-TRIZ Based AFD-1

AFD-1 method that is based on I-TRIZ and specialized for failure analysis has been discussed and explained including theory of scenario structuring in chapter 2. In chapter 3, shortcomings of AFD are elaborated, which encompass neglect of system interactions, pretermission of vulnerability analysis, and neglect of system integrality due to assumptions of AFD method that system and phases of an activity are always modular or linearly networked. AFD-1 approach to failure analysis will be remodeled to take those listed omissions into consideration to empower the tool to trace failure to lowest form-form connection of a system. Design structure matrix (DSM) is embedded in SIVAI-TRIZ based AFD approach, which offers compact framework and knowledge base for analyzing system interactions. The strength of this new AFD-1 method is that it can offer flexibility to trace failure to lowest part of systems whether integral or modular.

4.1 SIVAI-TRIZ Based AFD-1 Template

Modified AFD-1 template that is explained below is based on SIVAI-TRIZ. SIVAI-TRIZ is an acronym that is coined from system interactions, vulnerability analysis, innovation, and theory of inventive problem solving, which is extended form of I-TRIZ. This new approach is antithetical to AFD assumption that complex systems are always modular or activity phases are always linearly networked, which is the reason why practical paradigm that complex systems are much integrated as they modularized is neglected in AFD. This new approach distorted the AFD paradigm and technically methodized the practical paradigm which flushes out possibilities

of having different forms of scenario depending on system architecture. Template of the new AFD method is presented in the following.

STEP 1: FORMULATE THE ORIGINAL PROBLEM

In this step, formulate the "*original problem*". Here, stating original problem refers to naming the system, indicating the purpose for which it is made, and describing the failure. The failure description must contain definition of four variables which characterize problem boundary, which are **system failure**, **condition**, **season** and **place** in which the failure occurred.

Example, MKF *radiation pyrometer* is a device designed to *sense temperature of a distant object*. The pyrometer started *displaying inaccurate readings of measurement* when it was used in *cloud of dust particles* during *Harmattan* season in *Sub-Sahara Africa*.

The failure description shown above satisfies the requirements that a problem must contain four variables that characterize a problem of system; such as **system failure** *started displaying inaccurate measurement*, **condition** *in cloud of dust particles*, **season** *Harmattan*, **place** *Sub-Sahara Africa* Each of these variables carries important details for specializing solution to the problem.

STEP 2: IDENTIFY ELEMENTS OF SUCCESS SCENARIO

Identify subsystems, inputs, functions, and their outputs. In the case of an activity, identify the phases and desired results that are expected to be accomplished at each phases. Essence of this step is to gain familiarity of system in question.

Here, pyrometer block diagram is used as an example.

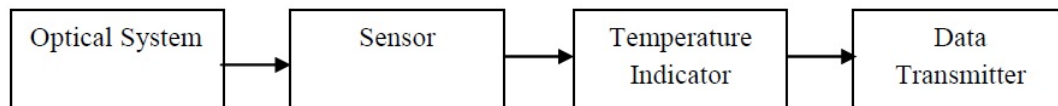

FIGURE 4.1: Block Diagram of Radiation Pyrometer

Subsystem	Inputs	Output
Optical System	infrared energy	energy
Sensor	converged infrared	signal
Temperature Indicator	analog signal readings	digital readings
Data Transmitter	digital data	data

Subsystem	Function
Optical System	sends converged Infrared energy
Sensor	detects and sends infrared energy as analogue signal
Temperature Indicator	Reads and Displays measurements
Data Transmitter	Transmits data

STEP 3: LOCALIZE THE FAILURE

Step 3.1: Map Subsystem Dependencies to DSM

Map subsystem dependencies to DSM matrix since system at its first level comprises a set of subsystems that are coupled together. Important things to bear in mind while mapping system dependencies to DSM matrix are recognition of where there are vector flows in a system and directions which they flow. Vector flow between two subsystems can be represented with characters 'X' and no flow between two subsystems can be represented with 'O'; then localize the failure using DSM matrix because it has compact information about system interactions

Using example shown above, system interactions in pyrometer block diagram can be mapped to DSM matrix as shown below. Interactions can flow from up to down, which means subsystem from which a vector flows should be represented on columns of DSM matrix and the other to which a vector flows should be represented on rows of the matrix.

	Optical System	sensor	Temperature Indicator	Data Transmitter
Optical system		O	O	O
Sensor	X		O	O
Temperature Indicator	O	X		O
Data Transmitter	O	O	X	

Strength of flow between two subsystems can be represented in DSM matrix by varying values between zero and one.

	Optical System	sensor	Temperature Indicator	Data Transmitter
Optical system	0	0	0	0
Sensor	1	0	0	0
Temperature Indicator	0	1	0	0
Data Transmitter	0	0	1	0

Now, different analysis can be performed on DSM matrix such as DSM partitioning. Degree of modularity and form of system failure scenario tree can be checked using SMI model. SMI greater than 0.99 means that system is modular and has s -shaped scenario tree; SMI less than 0.99 shows that system has shape of scenario tree, which is different from s -shape

Steps to Calculate SMI

Create Matrix of a System: this is square matrix of n -by- n order, where n is the number of subsystems, components or basic elements that are connected in a level of system architecture. Example, matrix of radiation pyrometer is 4-by-4 order because there are n -subsystems in the first level of the system architecture.

$$DSM_P = \begin{bmatrix} 0 & 0 & 0 & 0 \\ 1 & 0 & 0 & 0 \\ 0 & 1 & 0 & 0 \\ 0 & 0 & 1 & 0 \end{bmatrix}$$

$$DSM_S = DSM_P DSM_P^T \quad (4.1)$$

Calculate eigenvalues $\lambda_1, \lambda_2, \lambda_3 \dots \lambda_n$ of the DSM_S and singular values which are square roots of the eigenvalues of a system, $\alpha_1 = \sqrt{\lambda_1}, \alpha_2 = \sqrt{\lambda_2}, \alpha_3 = \sqrt{\lambda_3} \dots \alpha_n = \sqrt{\lambda_n}$.

Calculate SMI using $\alpha_1, \alpha_2, \alpha_3, \dots \alpha_n$. This can be done iteratively using equation 3.1.

- $SMI > 0.999$ implies that analysis can be based on system phases without loss of important information.
- $SMI \leq 0.99$ implies some important information will be lost if analysis is based on system phases only. Use SIVAI-TRIZ approach in this case.

Step 3.2: Identify the Failure

Use information captured by DSM as knowledge base to identify subsystem at which the failure occurred through analyzing subsystem interactions.

Using pyrometer problem as an example, problem of the system is localized at interaction between optical system and sensor.

	Optical System	sensor	Temperature Indicator	Data Transmitter
Optical system		O	O	O
Sensor	X		O	O
Temperature Indicator	O	X		O
Data Transmitter	O	O	X	

NOTE! Step 1 to step 3 can be repeated until the basic element at which the failure emanated is identified. The idea is to apply systematic approach by firstly identify a problem at first level of form-form dependency (subsystem level), second level of form-form dependency (component level), and then third level of form-form dependency (basic element level) at which the problem originates. How many times step 1 to 3 can be repeated until problem is identified at basic element level depends on system architecture.

STEP 4: FORMULATE THE PROBLEM AT SUBSYSTEM LEVEL

Formulate the problem at subsystem level with respect to the four variables of system failure.

Example, *MKF optical system* is a system that *converges infrared energy from hot body to sensor*; it appears *dusty and partially converges infrared energy* when it was used *in cloud of dust particle in Harmattan season in Sub-Sahara Africa*. Now, it can easily be noticed that there are five variables that define a problem at this level. Additional variable here is **appearance dusty** of the subsystem.

STEP 5: IDENTIFY ELEMENTS OF SUCCESS SCENARIOS

define component functions, Inputs, and success results (outputs). This is same with step 2. The number of subsystems, components, basic elements that can be identified here is $n+1$. Every subsystem, component or basic element has a part that connects it to the rest of the system. Reconsider that part in this step, so that information cannot be lost. As such, function-form dependency is re-identified.

Example: Using the block diagram of optical system at which the failure occurred in the first form-form dependency, component function can be identified as in step 2. Five components can be identified in the block diagram besides hot object as illustrated in figure 4.2

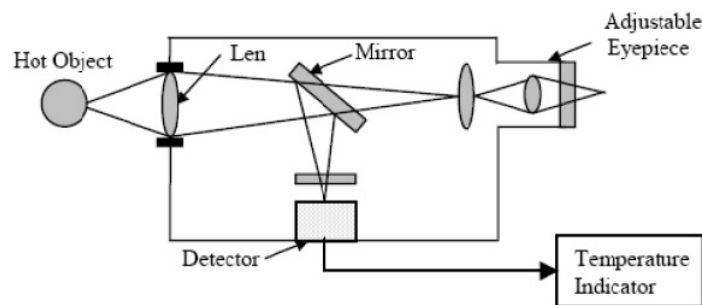

FIGURE 4.2: Schematic of Optical System [7]

Components	Inputs	Output
Front Lens	infrared energy	converged infrared energy
Mirror	converged infrared energy	reflected infrared energy
Middle Lens	converged rays	diverged rays
Back Lens	diverged rays	converged rays
sensor	converged infrared energy	electrical signal

Component	Function
Front Lens	Converges infrared energy to mirror
Mirror	reflects converged infrared energy to sensor
Middle Lens	diverges rays to back lens
Back Lens	converges rays to eye piece
Sensor	convert infrared to electrical signal

STEP 6: LOCALIZE THE FAILURE AT COMPONENT LEVEL

Step 6.1: Map component dependencies to DSM

Map component dependencies to DSM as showed in step 3. Details in step 3 can be repeated at this step.

	Back Lens	Middle Lens	Mirror	Front Lens	Sensor
Back Lens		X	O	O	O
Middle Lens	O		X	O	O
Mirror	O	O		X	O
Front Mirror	O	O	O		O
Sensor	O	O	X	O	

Calculate SMI Model

Use matrix of component at which the failure emanated, equation 4.1 and equation 3.1 to calculate SMI as showed in step 3.

Example the matrix of optical system from which the failure originated in pyrometer is as shown below

$$DSM_P = \begin{bmatrix} 0 & 1 & 0 & 0 & 0 \\ 0 & 0 & 1 & 0 & 0 \\ 0 & 0 & 0 & 1 & 0 \\ 0 & 0 & 0 & 0 & 0 \\ 0 & 0 & 1 & 0 & 0 \end{bmatrix}$$

Identify the Problem at Component Level

Use the DSM matrix that has compact information about interactions in a component to identify the source of problem at this level of system architecture.

For example, failure of pyrometer fall at the interactio between front lens and mirror as shown below.

	Back Lens	Middle Lens	Mirror	Front Lens	Sensor
Back Lens		X	O	O	O
Middle Lens	O		X	O	O
Mirror	O	O		X	O
Front Mirror	O	O	O		O
Sensor	O	O	X	O	

FORMULATE THE PROBLEM AT BASIC ELEMENT LEVEL

Formulate the problem at third level of form-form dependency (basic elements of the system).

Example, MKF *front lens* is a basic element that *Converges infrared energy to reflector* (mirror); MKF front lens *unevenly converges infrared energy* when it was used in *cloud of dust particle* in *Harmattan* season in *Sub-Sahara Africa*.

STEP 8: INVERT AND AMPLIFY THE PROBLEM AT THIS LEVEL

Apply typical I-TRIZ approach –invert and amplify failure; reformulation, inversion and amplification of the problem should be done in manner that supports thinking on how to synthesize the failure rather than guess possible causes from physical attributes of failure.

Example, formulate the problem at this third level of form-form dependency (basic elements of the system). this can be done as thus: *It is crucial to produce dusty particle on the lens and its uneven convergence of infrared energy to reflector (mirror)*.

Amplify the problem as thus: *it is crucial to produce dust particle on the lens and its uneven distribution of infrared energy on the entire lens area.*

STEP 8: SEARCH FOR SOLUTIONS

Use I-TRIZ database and other sources of information to find out area of discipline where such failure is intentionally produced. This is a guide to identify necessary information about resources and method of producing the failure. This needs intense search of information in various databases. I-TRIZ software offers help in this regard.

STEP 8.1 Search for Resources

- *Identify resources required for realization of the phenomenon.*
- *Find necessary resources in the system and its surrounding.*

Step 8.2: Use the Resources to Produce the Failure

Use the resources found around or within the system and identified method to synthesize the failure. If it fails, it indicates that there is missing resources. Identify the missing resources and try to generate it from the present resources. If the resources cannot be generated from the present ones, proceed to step 8.3.

Step 8.3: ARIZ (Algorithm for Inventing Problem Solving)

Apply ARIZ to reveal a way of synthesizing the problem. ARIZ is explained in detail in chapter 2 of this thesis.

STEP 9: FORMULATE HYPOTHESIS AND VERIFY IT

In this step, formulate hypothesis about how the problem occurred and verified its validity.

STEP 10: CORRECT THE FAILURE

Prescribe corrective or eliminative measures for the failure.

Chapter 5

SIVAI-TRIZ Based AFD-2

SIVAI-TRIZ based AFD-2 is methodized for predicting and revealing system failures. DSM matrix and vulnerability analysis are applied in this method to predict and make list of possible failures in order to reveal failure scenarios and recommend corrective measures. It is sophisticated RA tool for improving system quality because it captures total number of system interactions in a DSM compact frame, which offers bases with which possible failures can be identified, revealed and corrected. The template is as shown in the following.

5.1 SIVAI-TRIZ Based AFD-2

Three prominent approaches of this sophisticated RA tool encompass predicting possible future failures, revealing their scenarios, and correcting or eliminating their negative impacts to improve safety standard of a system. In this method, I-TRIZ principles and ARIZ are repetitively applied to list of future failures (IEs, MDs, and ES) to reveal their scenarios. Repetitively applying I-TRIZ principles and ARIZ is recurrent process of searching failures and revealing their scenarios, which is very crucial to enhance safety.

STEP 1: STATE THE ORIGINAL PROBLEM

Define the system in this step: state its name and purpose; for example, system [A] is designed and created for [state purpose which it serves]. The main aim of this analysis is finding all future failures that can occur as result of using it and identifying their scenarios for recommending corrective measures.

STEP 2: IDENTIFY SYSTEM SUCCESS SCENARIOS

This step is same as showed in step 2 of SIVAI-TRIZ based AFD-1. Reference can be made to chapter 4. State system inputs and outputs and define their functions.

STEP 3: GATHER SYSTEM INFORMATION Gather system information through reading system manuals, its block diagram and operation mechanism.

STEP 3.1: Map System Schematic to DSM Matrix

Map dependencies to DSM: system dependencies can be mapped to DSM by identifying both vector flows and component to which it flows. The flows can be mapped to DSM.

Example, these are vector flows in optical system that is used as example in chapter 4.

Mirror → Sensor

Front Lens → Mirror

Mirror → Middle Lens

Back Lens → Eye Piece

Middle Lens → Back Lens

It can be mapped to DSM as showed in the matrix below. The information flows (vector flows) are represented in such a way that they flow from columns to rows of the matrix

	Back Lens	Middle Lens	Mirror	Front Lens	Sensor
Back Lens		X	O	O	O
Middle Lens	O		X	O	O
Mirror	O	O		X	O
Front Mirror	O	O	O		O
Sensor	O	O	X	O	

Identify undesired interactions and survey required resources: in the DSM matrix, identify desired interactions between two interacting components and use it to identify possible failures that can result from the interactions. List these possible failures for every interaction between two components in DSM matrix. The practice of using desired interactions to identify undesired interactions and survey required resources is in alignment with ideality principle.

Step 3.2: Check Scenario Structure of the System

Check scenario structure of the system (Hint: use SMI equation 3.1 as showed in chapter 4) to know whether the system has *s*-shaped scenario tree.

Step 3.3: Catalogue the IE's, MD's, and ES's

Archive the initiating events, middle states and end states. Catalogue them with respect to components of the system or activity phases.

Connect IE's, MD's, and IE's to Scenario Tree

Initiating events (IEs), mid states (MDs), and end states (ES's) can be systematically connected in scenario tree. This is can be done according to scenario structure implies by SMI model. For example, if SMI is unity, scenario tree is *s*-shaped. If it is not unity, scenario tree has different form that depends on system architecture.

STEP 4: INVERT AND AMPLIFY THE PROBLEMS

Invert and amplify catalogued failures in such a way that their phenomena can be synthesized rather than examine and conclude based on physical attributes of failures as in traditional risk analysis. What is explained and detailed in chapter 4 about problem inversion and amplification is same with this step.

STEP 5: IDENTIFY METHODS AND SURVEY RESOURCES

Identify methods: search various branch of learning, engineering, science, et cetera where phenomena of the future failures are intentionally produced. This is same with mapping problem abstract category to its solution abstract category as explained in chapter 1.

Identify resources: catalogue resources used in the methods and Identify resources that are present in the system. Find a way to produce failure using the resources. This step is same with step 7 and step 8 of SIVAI-TRIZ based AFD-2 in chapter 4.

STEP 6: VULNERABILITY ANALYSIS**Step 6.1: Gather Information about Sensitivity of System**

Gather information about responsiveness of system parts to resources around or within them and possible failures that can result when they are stressed beyond safety limits and cannot regain their functions.

Step 6.2: Survey All Resources

Identify resources and isolate perturbations, stressors or stress to basic elements, components, and subsystems of system.

Step 6.3: Survey Interactions among Perturbations

Survey interactions among stressors; two or more perturbations may interact to yield a stressor that can cause system failure.

Step 6.4: Check System Attenuation of Vulnerability

Check how subsystems attenuate vulnerabilities to stressors, perturbations and interacting stressors; this is the same with performing failure analysis using AFD-1, so SIVAI-TRIZ and ARIZ are applicable in this step.

Step 6.5: Synthesize Failure of Vulnerability

Failures of vulnerability of system can be produced using resources, perturbations, stressors, interacting stressors and systematically connect scenarios to scenario tree of system. AFD-1 can be recursively applied to reveal scenarios that emanate from vulnerability to resources, stressors and interacting perturbations.

STEP 7: USE AFD KNOWLEDGE BASE

Study AFD checklist to find some factors that may associate with the initiating events, mid states and end states. These set of AFD checklist are attached to appendix section. Any discovered scenario should be added to the scenario tree.

STEP 8: FIND POSSIBILITY OF GROWING THE TREE

Use ARIZ concept to find means of producing new end states or already identified end states with available initiating events, mid states, and end states. As such, ARIZ is used to recursively find new ways of producing already identified end states or new end states. This is the same with searching through scenario tree of

system and trying to find different ways of producing new or already existing end states using available system resources, initiating events, mid states and end states.

STEP 9: INTENSIFY AND MASK HARMFUL EFFECT

In this step, intensify or worsen the harmful effect. The essence of worsening or intensifying harmful effect is to identify scenarios that can occur when a system failure mechanism extends over time. This step can reveal scenarios that are not captured by the above steps.

STEP 10: ORGANIZE THE SCENARIO TREE

Scenario tree must be made neater, traceable and understandable; then, Corrective or eliminative measure can be implemented.

Chapter 6

SIVAI-TRIZ Based AFD-3

So far, the two AFD methods have been modified to eliminate shortcomings that are inherited when they are used to perform risk analysis. Modified AFD-1 has capability that can be used to trace failure at lowest level of system architecture and reveal its scenario. Modified AFD-2 has capability that can be utilized as basis to reveal scenarios which take place before initiating events. Although these two modified AFD methods are very sophisticated to perform failure analysis and failure prediction, none has strong capability that can be used to capture and reveal failure due to human error, bad ergonomics, or organizational error. Thus, AFD-3 is systematically structured to capture and reveal scenario of failure due to human error, organizational error, bad ergonomic design and other failures (problems) that lies in manufacturing system.

Manufacturing system is complex system that has many subsystems, processes, materials, organizations, and resources which are arrayed in layers and structure that facilitate creation of product. It often becomes difficult task to identify root causes of unintended behavior or product failure after manufacturing, assembling, and dispatching product to market because of complexity of manufacturing system. For example, Toyota called for return of some Toyota brands because of unintended accelerations in 2009. Likewise, Boeing called for return of its 787 Dreamliner after electrical faults forced unplanned landings last year. Boeing could not identify root causes of the fault as urgent as masses expected despite that it caused wide spread of fear and criticism.

Technical need to find root causes of unintended behavior of system after manufacturing, assembling, and dispatching comes up once or twice in a year. AFD-3

method that is structured on fundamental principles of SIVAI-TRIZ is proposed for solving such technical problem. This new AFD method can be used for purpose of failure analysis – it is in same class with AFD-1, but both provide different capabilities for solving different class of problem.

6.1 AFD-3 Template

AFD-3 embodies framework for managing system knowledge. Transformation method provides good bases for analyzing a domain with information from another domain. For example, transformation method is a means by which DM information can be mapped to DSM which can provide bases for identifying source of DP failure. This mapping method provides way to link system emergent behavior to design parameters and process variables, which is crucial for identifying root causes of design failure and revealing its scenario. The template is showed in the following.

STEP 1: FORMULATE THE ORIGINAL PROBLEM

This step is same with step 1 in AFD-1: formulate original problem. This includes naming the system, stating its purpose, and describing the failure or unintended behavior that has appeared. It is crucial to find root causes of the unintended behavior of the system.

STEP 2: IDENTIFY SUCCESS SCENARIO

This step is same with step 2 of modified AFD-1: state the subsystems (phases), inputs, subsystem functions, and outputs. State and arrange inputs, subsystem functions, and outputs in way that can show the system mechanism in a glance. Reference can be made to chapter 4.

STEP 3: LOCALIZE THE FAILURE

STEP 3.1: Map System Dependency to DSM

Map subsystem dependencies to DSM matrix. Vector flow in the DSM matrix should be represented in a way that information flows from column to row of DSM matrix. Typical example on how to map system dependencies to DSM can be revisited in chapter 4.

Step 3.2: Identify the Failure

Analyze and pinpoint failure source using compact information captured by the DSM matrix. This is same with identifying failure in a system or subsystem, which is done by examining and drawing inferences about system interactions.

	<i>Subsystem</i> ^①	<i>Subsystem</i> ^②	<i>Subsystem</i> ^③	<i>Subsystem</i> ^④	<i>Subsystem</i> ^⑤
<i>Subsystem</i> ^①		X	O	O	O
<i>Subsystem</i> ^②	O		X	O	O
<i>Subsystem</i> ^③	O	O		X	O
<i>Subsystem</i> ^④	O	O	O		O
<i>Subsystem</i> ^⑤	O	O	X	O	

STEP 4: FORMULATE THE PROBLEM AT SUBSYSTEM LEVEL

Formulate the problem captured in step 3, state subsystem purpose, describe the failure that has occurred at the first level of form-form dependency, and condition under which it occurred.

STEP 5: STATE SUCCESS SCENARIO AT THE SUBSYSTEM LEVEL

Define component functions, Inputs, and success results (outputs).

STEP 6: LOCALIZE THE FAILURE AT COMPONENT LEVEL

Map dependencies at component level to DSM and identify the source of failure at this level. This is second level form-form dependency of system architecture.

	<i>Component</i> ^①	<i>Component</i> ^②	<i>Component</i> ^③	<i>Component</i> ^④	<i>Component</i> ^⑤
<i>Component</i> ^①	O	O	O	O	O
<i>Component</i> ^②	O	X	O	O	O
<i>Component</i> ^③	O	O	X	O	O
<i>Component</i> ^④	X	O	O	X	O
<i>Component</i> ^⑤	O	O	X	O	X

STEP 7: GATHER REQUIRED INFORMATION

Step 7.1: Consult Design Document

Gather information about component which the failure originated. Design sheet that summarizes details about elemental parts of the component can be used in this step. Important document to look for is document that has details about history of design matrix (DM) because design matrix of axiomatic design has information about translation of functional requirements (FRs) to design parameters (DPs). As shown below, typical DM matrix carries information of relationship between FRs and DPs.

	DP_1	DP_2	DP_3	DP_4
FR_1	X	O	X	X
FR_2	X	X	O	X
FR_3	X	X	X	O
FR_4	O	X	X	X

Step 7.2: Map DM Information to DSM

Use transformation method to map DM information to DSM. Row matrix permutation can be used. Design matrix of axiomatic design (DM) is transformed to design structure method (DSM) as shown below. Mapping DM to DSM is done in a way that output variables occupy diagonal of DSM matrix. Detailed example is given in chapter 3 on how to map DM to DSM.

	DP_1	DP_2	DP_3	DP_4
FR_1	X	O	\boxed{X}	X
FR_2	X	\boxed{X}	O	X
FR_3	\boxed{X}	X	X	O
FR_4	O	X	X	\boxed{X}

 $\xrightarrow{DMtoDSM}$

	DP_1	DP_2	DP_3	DP_4
DP_1	\boxed{X}	X	X	O
DP_2	X	\boxed{X}	O	X
DP_3	X	O	\boxed{X}	X
DP_4	O	X	X	\boxed{X}

STEP 8.0: LOCALIZE THE FAILURE AT DP LEVEL

In this step, identify design parameter from which the failure emanates; design parameter (DP) from which the failure emanates can be identified by studying interactions between design parameters (DPs) in DSM matrix. This is as depicted below.

	DP_1	DP_2	DP_3	DP_4
DP_1		X	X	O
DP_2	X		O	X
DP_3	X	O		X
DP_4	O	X	X	

STEP 9: LOCALIZE THE DP FAILURE AT PROCESS DOMAIN

Design parameter (DP) from which the failure emanates is identified in step 8. Use identified DP, design archive, and production archive to pinpoint manufacturing process in which the DP is created or used to design a product. Root causes of the DP problem are present in either process from which the DP is created or process in which it is used to characterize a product. Figure 3.9 which illustrates system knowledge management in chapter 3 can be revisited for clarity.

STEP 10: FORMULATE, INVERT, AND AMPLIFY THE PROBLEM

Formulate the DP problem at process domain, invert, and amplify the problem as in typical AFD method. Important hint to keep in mind is that the DP attributes carry description of the failure that can be synthesized. As such, the DP can be formulated as shown in the following.

- *It is crucial to synthesize DP attributes (problem) under condition of process from which it is created using resources which are available in the manufacturing process*

DP problem can be amplified as thus:

- *It is crucial to synthesize the problem on many DPs under condition of process from which it is created using resources which are available in the manufacturing process*

STEP 11: SEARCH FOR SOLUTION

Step 11.1: Search for Apparent Solution

Search for general solution to inverted and amplified problem in various branches of engineering, sciences, research, and other endeavors. Identify the method of the general solution that is used to create the phenomenon of the problem as in typical AFD method. AFD has specialized software package that may help in this case.

Step 11.2: Identify Resources in the Manufacturing Process

In this step, survey and list out resources that are used to intentionally create phenomenon of the DP problem. Also, Use those surveyed resources which are used to create the phenomenon to check for availability of their counterparts in the manufacturing process. If those resources are present in manufacturing process, the identified general solution is compatible solution to DP problem.

Step 11.3: Utilize the Identified Resources to Produce the DP Problem

Use identified resources and method to produce phenomenon of the failure. If any resource which is used in the method to intentionally produce phenomenon of the problem is missing in the identified resources that are available in manufacturing process, search for a way of producing the missing resources from those that are apparently available. There may be biological effect, chemical effect or physical effect that can be used to synthesize missing resources. If there is any biological effect, chemical effect, or physical that can be used to synthesize missing resource, check for presence of the effect in manufacturing process. The solution is uncompromised if the effect is available in the process.

Solution is specialized solution to the DP problem if biological effect, chemical effect, or physical effect that is used to produce missing resource is available in manufacturing process; otherwise, proceed to next step.

Step 11.4: ARIZ (Algorithm for Inventive Problem Solving)

Recap the problem, reformulate it, state ideal state, and find a means of reaching ideal state using available resources and condition that accompanies or under which the problem surfaced. ARIZ is explained in detail in chapter 3.

STEP 12: FORMULATE HYPOTHESIS AND VERIFY IT

In step 12, formulate hypothesis of specialized solution to the inverted problem and verify its validity and trueness.

STEP 13: IMPLEMENT MEASURE FOR THE PROBLEM

Implement measure to correct, avert, or eliminate the problem.

Chapter 7

Practical Examples

In this chapter, practical applications of modified AFD-1, modified AFD-2 and AFD-3 are demonstrated to show ‘step-by-step’ approach of using those three methods to solve system problems. Although the examples that are used to practically illustrate applications of the methods are not empirical problems, the examples are compatible with sets of complex system failures that can be solved using the methods. Such practical applications to those problem examples which are compatible with empirical problems of system failures reveal future work that can be done to enhance potency of AFD methods. The future work is stated and explained in this chapter.

7.1 Radiation Pyrometer Failure Analysis

An industry that manufactures radiation pyrometer has been receiving customers’ complaints about inaccurate temperature measurements when its system is used in field work. The customers complained that the problem normally occurs six months after using it in field work. The industry had researched, surveyed, and found out that fields in which the system normally develops the fault while in use has cloud of dust particles which cannot impede its functionality. Sensor was initially pinpointed as source of the problem, but technical examination, condition monitoring, and data analysis show that it is functioning properly. Engineers are finding a way to solve this problem to avoid losing its brand reputation and customers, but they are unable to pinpoint root causes of the problem.

7.1.1 Application of SIVAI-TRIZ Based AFD-1

Malfunctioning radiation pyrometer is typical example of failure analysis; suitable AFD method for this class of problem is AFD-1. Step-by-step approach of performing system failure analysis with modified AFD-1 method is shown in the following.

STEP 1: FORMULATE THE ORIGINAL PROBLEM

There is a system named radiation pyrometer, which is used to measure temperature of distant hot body. It is camera-like system which has eyepiece, rotating knob for adjusting focus, and surfactant material that covers its lens. It often develops problem of inaccurate measurement when it is used in cloud of dust particles in field work in Sub-Sahara Africa.

STEP 2: STATE SUCCESS SCENARIOS

Success scenarios of the system are stated in below depicted table. The schematic of the system is illustrated in figure 4.1 which can be revisited in chapter 4.

Subsystem	Inputs	Output
Optical System	infrared energy	energy
Sensor	converged infrared	signal
Temperature Indicator	analog signal readings	digital readings
Data Transmitter	digital data	data

Subsystem	Sucess Scenario
Optical System	sends converged Infrared energy
Sensor	detects and sends infrared energy as analogue signal
Temperature Indicator	Reads and Displays measurements
Data Transmitter	Transmits data

STEP 3: LOCALIZE THE FAILURE

Step 3.1: Map Subsystem Interactions to DSM Matrix

Figure 4.1 which is block diagram of radiation pyrometer has subsystem interactions that can be mapped to DSM as thus: converged radiation that flows from optical system to sensor is represented with 'X in [optical system, sensor] of DSM

matrix; electrical signal that flows from sensor to temperature indicator is represented with 'X' in [sensor, temperature indicator]; digital data that flow from temperature indicator to data transmitter is represented with 'X' in [temperature indicator, data transmitter] of DSM matrix. Strength of flows in the system is denoted with numerical values that can range between '0' and '1'.

	Optical System	sensor	Temperature Indicator	Data Transmitter
Optical system		O	O	O
Sensor	X		O	O
Temperature Indicator	O	X		O
Data Transmitter	O	O	X	

Strength of flow between two subsystems can be represented in DSM matrix by varying values between zero and one.

	Optical System	sensor	Temperature Indicator	Data Transmitter
Optical system	0	0	0	0
Sensor	1	0	0	0
Temperature Indicator	0	1	0	0
Data Transmitter	0	0	1	0

Calculate SMI of the DSM Matrix

$$DSM_P = \begin{bmatrix} 0 & 0 & 0 & 0 \\ 1 & 0 & 0 & 0 \\ 0 & 1 & 0 & 0 \\ 0 & 0 & 1 & 0 \end{bmatrix}$$

Using equation 4.1, the product of DSM_P and DSM_P^T is equal to:

$$DSM_S = \begin{bmatrix} 1 & 0 & 0 \\ 0 & 1 & 0 \\ 0 & 0 & 1 \end{bmatrix}$$

$$(DSM_S - \lambda I) = \begin{bmatrix} 1 - \lambda & 0 & 0 \\ 0 & 1 - \lambda & 0 \\ 0 & 0 & 1 - \lambda \end{bmatrix}$$

$\lambda_1 = \lambda_2 = \lambda_3 = 1, \lambda_4 = 0$ and $\alpha_1 = \sqrt{\lambda_1} = \alpha_2 = \sqrt{\lambda_2} = \alpha_3 = \sqrt{\lambda_3} = 1;$
 $\alpha_4 = \sqrt{\lambda_4} = 0$

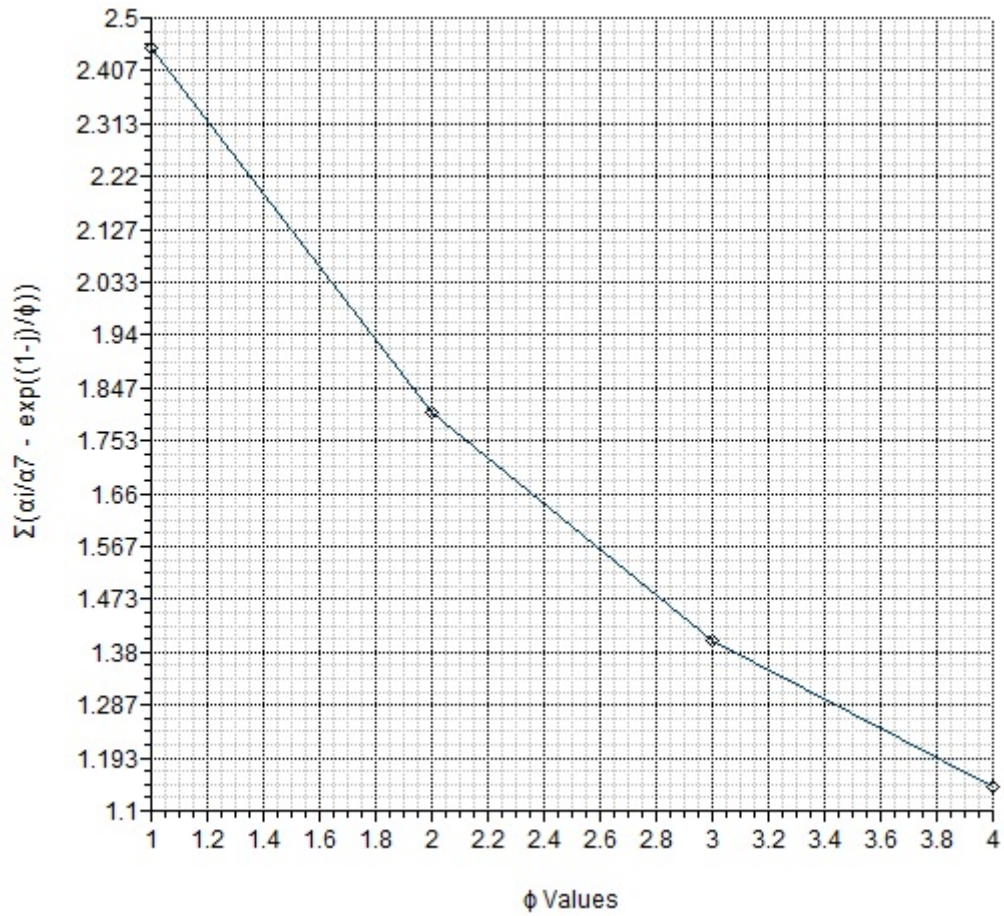

FIGURE 7.1: Graph of $\sum_{i=1}^N |\frac{\alpha_i}{\alpha_1} - \exp^{\frac{1-i}{\Phi}}|$ against Φ

The equation 3.1 is solved iteratively and $\sum_{i=1}^N \left| \frac{\alpha_i}{\alpha_1} - \exp^{\frac{1-i}{\Phi}} \right|$ is plotted against Φ as showed in the figure 7.1 above. $SMI = \frac{\Phi^*}{N}$, where Φ^* is value of Φ for which $\sum_{i=1}^N \left| \frac{\alpha_i}{\alpha_1} - \exp^{\frac{1-i}{\Phi}} \right|$ is minimum. Φ^* is 4 according to figure 7.1 and $N = 4$. $SMI = \frac{4}{4} = 1$. $SMI = 1$ implies that first level form-form dependency of the system is modular and failure analysis can be based on phases of the first level without losing information.

Step 3.2: Identify the Failure at Subsystem Level

DSM is used to pinpoint the source from which the failure emanates. The failure emanates from optical system as shown below.

	Optical System	sensor	Temperature Indicator	Data Transmitter
Optical system		O	O	O
Sensor	X		O	O
Temperature Indicator	O	X		O
Data Transmitter	O	O	X	

STEP 4: FORMULATE THE PROBLEM AT SUBSYSTEM LEVEL

MKF optical system is a system that collects infrared energy from hot body and converges it to sensors; it appears dusty and partially converges infrared energy when it was used in cloud of dusty particle in field work in Sub-Saharan Africa.

STEP 5: IDENTIFY SUCCESS SCENARIOS

Components	Inputs	Output
Front Lens	infrared energy	converged infrared energy
Mirror	converged infrared energy	reflected infrared energy
Middle Lens	converged rays	diverged rays
Back Lens	diverged rays	converged rays
sensor	converged infrared energy	electrical signal

Component	Function
Front Lens	Converges infrared energy to mirror
Mirror	reflects converged infrared energy to sensor
Middle Lens	diverges rays to back lens
Back Lens	converges rays to eye piece
Sensor	convert infrared to electrical signal

STEP 6: LOCALIZE THE FAILURE AT COMPONENT LEVEL

Step 6.1: Map Component Interaction to DSM Matrix

The failure emanates from optical system which is one of those subsystems in radiation pyrometer. Analysis can be focused on optical system to localize the failure at second level of form-form dependency. Component interactions are mapped to DSM matrix as shown in the following. Figure 4.2 which is block diagram of optical system can be revisited in chapter 4.

	Back Lens	Middle Lens	Mirror	Front Lens	Sensor
Back Lens		X	O	O	O
Middle Lens	O		X	O	O
Mirror	O	O		X	O
Front Mirror	O	O	O		O
Sensor	O	O	X	O	

Calculate SMI of the DSM matrix

$$(DSM_S - \lambda I) = \begin{bmatrix} 1 - \lambda & 0 & 0 & 0 \\ 0 & 1 - \lambda & 0 & 0 \\ 0 & 0 & 1 - \lambda & 0 \\ 0 & 1 & 0 & -\lambda \end{bmatrix}$$

Row and column operations are performed on the DSM matrix to obtain:

$$(DSM_S - \lambda I) = \begin{bmatrix} 1 - \lambda & 0 & 0 & 0 \\ 0 & 1 - \lambda & 0 & 0 \\ 0 & 0 & 1 - \lambda & 0 \\ 0 & 0 & 0 & -\lambda \end{bmatrix}$$

$$\lambda_1 = \lambda_2 = \lambda_3 = 1, \lambda_4 = 0 \text{ and } \alpha_1 = \alpha_2 = \alpha_3 = 1, \alpha_4 = 0$$

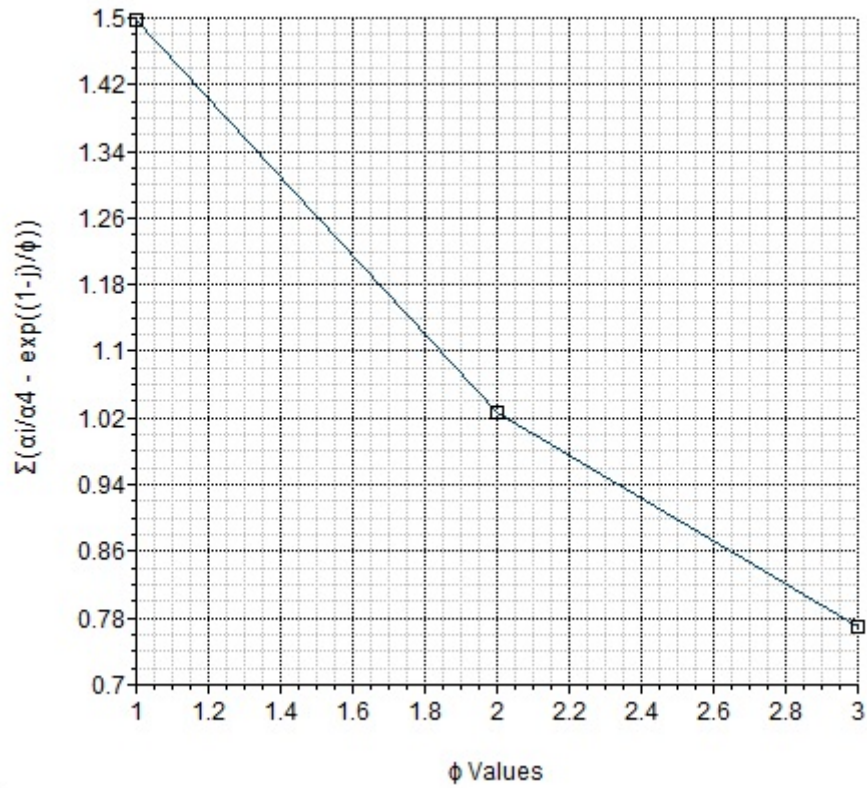

FIGURE 7.2: Second Graph of $\sum_{i=1}^N \left| \frac{\alpha_i}{\alpha_1} - \exp \frac{1-i}{\Phi} \right|$ against Φ

$SMI = \frac{\Phi^*}{N} = \frac{3}{4} = 0.75$; SMI is less than unity value which indicates that the subsystem is modularized as well as integrated. Optical system is modular-integral system. Analysis must be focused on all interactions to avoid loss of information.

Step 6.2 : Identify the Failure at Component Level

	Back Lens	Middle Lens	Mirror	Front Lens	Sensor
Back Lens	X	O	O	O	O
Middle Lens	O	X	O	O	O
Mirror	O	O	X	X	O
Front Mirror	O	O	O	X	O
Sensor	O	O	X	O	X

STEP 7: FORMULATE THE PROBLEM AT COMPONENT LEVEL

MKF lens is a component in optical system called front lens which is covered with amine-carboxylated-Perfluorocarbon material. It converges infrared energy to a mirror in optical system, but it developed failure of unevenly converging infrared energy to a mirror when it is used in cloud of dust particles in field work in Sub-Saharan Africa.

STEP 8: INVERT AND AMPLIFY THE FAILURE

It is crucial to produce lens failure of unevenly converging infrared energy to mirror using available resources and condition in which the system is used.

It is important that the failure of unevenly converging energy to mirror using available resources and condition in which the system is used.

STEP 9: SEARCH FOR SOLUTION

First step, search for general method of producing uneven convergence of infrared energy in lens. Example, I found in the internet that uneven convergence of infrared energy in lens is produced by deposition of dust particles and oil on lens. Now, the method of producing phenomenon of uneven convergence of infrared energy is found. Proceed to next step.

Step 9.1: Survey Resources**Step 9.1.1: Survey Resource in the Identified Method**

Resources used in the method: dust particles, oil, infrared energy, lens, and deposition.

Step 9.1.2: Survey Resources in the Formulated Problem

Available Resources in the problem are dust particles, wind, infrared energy, amine-carboxylated-Perfluorocarbon material, material permeability, material abrasiveness, and lens. Since the resources used in identified method are present in the formulated problem, solution for this problem is counterpart of the identified method and the method can be used to produce phenomenon of the system failure.

Step 9.2: Use the Resources to Produce the Failure

Deposition of dust particles on the “amine-carboxylated-Perfluorocarbon” material can be produced by wind, dust, and abrasiveness of the material: wind blows dust particles to deposit itself on amine-carboxylated-Perfluorocarbon material because of its abrasiveness. Now, how dust particles are deposited on amine-carboxylated-Perfluorocarbon material which covers front lens is revealed, but solution is to reveal how it is deposited on the lens. How can this be achieved with available resources in the formulated problem? Amine-carboxylated-Perfluorocarbon covers the lens, but it is permeable; amine-carboxylated-Perfluorocarbon material permeability is one of the resources of the formulated problem; thus, permeability can instigate diffusion process. Taking into consideration material permeability, deposition of dust particles on front lens can be synthesized by wind, dust particles, abrasiveness, and material permeability: wind blows dust particles to deposit itself on amine-carboxylated-perfluorocarbon material which its permeability instigates diffusion process that deposits dust particles on front lens.

Uneven convergence of infrared energy in lens can be produced through deposition of dust particles and oil on lens according to details in identified method; how dust particles are deposited on front lens are revealed, but how oil is deposited on front lens is not revealed. How can oil be deposited on the lens along with dust? The acceptable means to produce oil is through use of available resources in the formulated problem, but there is no known physical, chemical or biological effect by which oil can be produced using the available resources. As such, ARIZ can be applied.

STEP 9.3: Apply ARIZ (Algorithm for Inventive Problem Solving)**Step 9.3.1: Formulate Secondary Problem**

Uneven convergence of infrared through lens is realized by deposition of oil and dust particles and passing infrared energy through dust-oil contaminated lens. Deposition of dust particles is realized, but deposition of oil is not.

Step 9.3.2: State Ideal Solution

Produce oil using available resources in the formulated problem and deposit it on the lens by physical, chemical or biological process that is either present in the field where the system is used or generated as result of the available resources.

Step 9.3.3: Search for Solution

There are different methods of producing oil, but the method that is compatible with the secondary formulated problem is amine-carboxylated-Perfluorocarbon oil production method. By this method, oil droplets are produced by exposing carbonxylated –perfluorocarbon, amine, water to temperature change.

Step 9.3.3.1: Survey Resources

Resources used in the method: amine, carbonoxylated-perfluorocarbon, water, and temperature change.

Resources available in the problem: amine, amine-carboxylated-Perfluorocarbon, and temperature change.

Step 9.3.3.2: Produce the Phenomenon

One missing resources in the formulated problem is water, but water can be generated through evaporation and condensation by temperature change effect; water is produced through evaporation and condensation driven by temperature change: temperature increases in the day to instigate evaporation, but it drops in the night to instigate condensation process that produces water and wet front lens. Also, Produced water droplets, amine, and amine-carboxylated-Perfluorocarbon exposed to temperature increase during the day produces oil and deposits its droplets on the lens.

The deposited oil droplets, dust particle and infrared energy cause uneven convergence of energy from the front lens.

STEP 10: FORMULATE HYPOTESIS AND VERIFY IT

The solution can be hypothesized as thus: radiation Pyrometer used to measure temperature of hot body in cloud of dust particle in Sub-Sahara Africa unevenly converges infrared energy because of deposition of oil droplets and dust particles on front lens which diverges infrared energy from reflector (mirror).

STEP 11: CORRECT THE FAILURE

Implement measure to avert the problem.

7.2 Prediction of Future Failures of Boiler

An industry recently designed and manufactured a new system called biomass boiler. Users of this system are people of age that range from nine years old to upwards. The industry wants to predict failures of the system in order to implement measures to avert any possible failure to satisfy minimum safety requirement that is imposed by society.

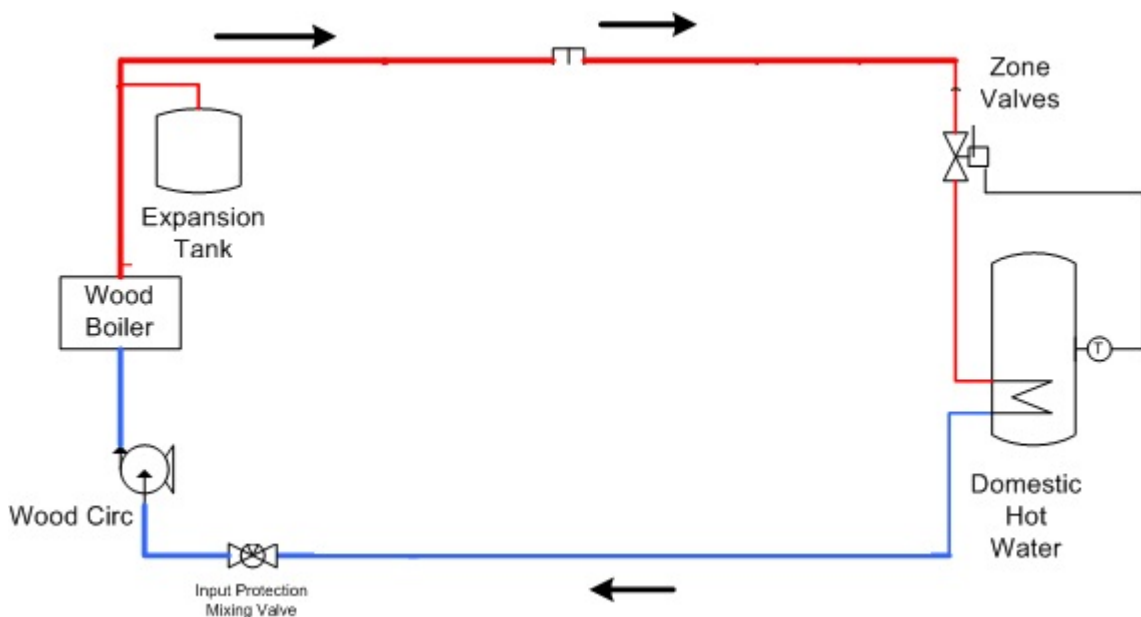

FIGURE 7.3: Schematic of Biomass Bioler [8]

7.2.1 Application of SIVAI-TRIZ based AFD-2

SIVAI-TRIZ based AFD-2 is principally used to perform failure prediction. It is applicable to the problem of predicting failure of biomass boiler.

STEP 1: FORMULATE THE ORIGINAL PROBLEM

There is a system called biomass boiler which is primarily designed to heat water for domestic use. The essence of this analysis is to predict future failures that can occur as result of using the system in order to eliminate them from the system.

STEP 2: STATE SUCCESS SCENARIOS

Subsystem	Success Scenario
Reservoir	Stores and pressures out water to valve
Protective Valve	Closes or opens flow path to circulator
Circulator	Moves the water to boiler
Boiler	Heats up water from circulator
Expansion Tank	Pressures water to valve
Valve	Closes or open flow path to reservoir

STEP 3: GATHER SYSTEM INFORMATION

Step 3.1: Map System Interaction to DSM

Interactions in biomass boiler depicted in figure 7.3 are mapped to DSM matrix as depicted in the following

	Reservoir	Protective Valve	Wood Circulator	Wood Boiler	Expansion Tank	Zone Valve
Reservoir		O	O	O	O	X
Protective Valve	X		O	O	O	O
Wood Circulator	O	X		O	O	O
Wood Boiler	O	O	X		O	O
Expansion Tank	O	O	O	X		O
Zone Valve	O	O	O	O	X	

In the DSM matrix, information flows from columns to rows. Information flow in the DSM matrix is: reservoir → protective valve → wood circulator → wood boiler → expansion tanks → Zone valve → Reservoir. In SIVAI-TRIZ AFD-2 method, DSM information flow determines mid states (MSs) and harmful end states (HESs) of a system. For example, initiating events at reservoir has negative impact on protective valve and other subsystems of the biomass boiler. These negative impacts can be labelled mid states (MSs) and harmful end states depending on their positions in DSM information flow – negative impacts at reservoir can be labelled HES and negative impact of initiating events at other subsystems can be labelled MSs in this example. For instance:

IE_{r1} : Low water flow from reservoir due to bad diaphragm

MS_{b1} : Very hot wood boiler due to low water flow

MS_{e1} : Too much steam in expansion tank

MS_{z1} : Too much heat stress on zone valve

HES_{r1} : Very hot water in reservoir

$IE_{r1} \rightarrow MS_{b1} \rightarrow MS_{e1} \rightarrow MS_{z1} \rightarrow HES_{r1}$

IE_{r2} : Too much water flow from reservoir

MS_{v1} : More pressure stress on protective valve

MS_{e2} : Steam reduction in expansion tank

MS_{z2} : Too much pressure stress on zone valve

HES_{r2} : Drop in temperature of water in reservoir

$IE_{r2} \rightarrow MS_{v1} \rightarrow MS_{e2} \rightarrow MS_{z2} \rightarrow HES_{r2}$

IE_{p1} : Protective valve not opening well

MS_{w1} : Formation of debris due to frictional impact at joint of wood circulator

MS_{b1} : Very hot wood boiler

MS_{e1} : Too much steam in expansion tank

MS_{z1} : Too much heat stress at zone valve

HES_{r1} : Very hot water in reservoir

$IE_{p1} \rightarrow MS_{w1} \rightarrow MS_{b1} \rightarrow MS_{e1} \rightarrow MS_{z1} \rightarrow HES_{r1}$

IE_{v2} : Blockage of flow through protective valve

MS_{w1} : Formation of debris due to frictional impact at joint of wood circulator

MS_{b2} : Very red hot wood boiler

MS_{b3} : Melting of filaments of boiler

MS_{e2} : Pressure drops in expansion tank

HES_{r3} : Reduction in volume of warm water in reservoir

$IE_{w2} \rightarrow MS_{w1} \rightarrow MS_{b2} \rightarrow MS_{b3} \rightarrow MS_{e2} \rightarrow HES_{r3}$

IE_{w2} : slowly spinning of circulator

MS_{f1} : Very low water flow through boiler

MS_{b1} : very hot wood boiler

MS_{e1} : too much steam in expansion tank

MS_{z1} : More heat stress at zone valve

HES_{r1} : Very hot water in reservoir

$IE_{w2} \rightarrow MS_{f1} \rightarrow MS_{b1} \rightarrow MS_{e1} \rightarrow MS_{z1} \rightarrow HES_{r1}$

IE_{e1} : Low expansion due to damage of diaphragm of expansion tank

HES_{r3} : Reduction in volume of warm water in reservoir

$IE_{e1} \rightarrow HES_{r3}$

Initiating events (IEs), mid states (MSs), and harmful end states (HESs) at the first level of form-form dependencies (subsystems) of biomass boiler are revealed as showed above, but root causes of those initiating events which appears at subsystems are not yet revealed. Root causes of those initiating events can be revealed by applying AFD-2 method to each subsystem as it is applied in biomass boiler that constitutes them (subsystems).

STEP 4: INVERT AND AMPLIFY THE PROBLEMS

Apply AFD-1 method to each initiating events, mid states, and harmful end states that are revealed in step 3.

STEP 5: SURVEY RESOURCES

New mid states or initiating events can be identified through surveying and analyzing interactions among resources used and generated in a system; for example, resources that are used and generated in the biomass boiler are cold water, hot water, pressure, fuel, wood, steam, temperature et cetera. IEs and MSs that can appear because of using the resource 'wood' in the system are:

IE_{w2} : Wood debris formation

MS_{v3} : Blockage of circulator by the wood debris

MS_{f2} : Low flow through boiler

MS_{b1} : Very hot boiler

MS_{e1} : Too much steam in expansion tank

MS_{z2} : More heat stress on zone valve

HES_{r1} : Very hot water in reservoir

$IE_{w2} \rightarrow MS_{v3} \rightarrow MS_{f2} \rightarrow MS_{b1} \rightarrow MS_{e1} \rightarrow MS_{z2} \rightarrow HES_{r1}$

STEP 6: VULNERABILITY ANALYSIS

Failures due to vulnerability of the biomass boiler can be identified in this step. Vulnerabilities can be assessed based on responsiveness of biomass boiler to resources that are situated within or around the system. It can also be a function of time because it may take long time in some system for vulnerability to be noticed.

Example:

IE_{c1} : Enfeebling circulator coil due to vulnerability to flow force and pressure

IE_{f1} : Loss of Filament mass due to vulnerability to heat and flow force

IE_{d1} : Damage diaphragm contraction and expansion due to vulnerability to steam and heat flux

$IE_{c1} \rightarrow MS_{f2} \rightarrow MS_{b1} \rightarrow MS_{e2} \rightarrow MS_{z2} \rightarrow HES_{r2}$

$IE_{f1} \rightarrow MS_{h1} \rightarrow MS_{e2} \rightarrow HES_{r2}$

$IE_{d1} \rightarrow MS_{f2} \rightarrow HES_{r3}$

STEP 7: USE AFD KNOWLEDGE BASE

In this step, AFD has knowledge base of system failures. The AFD database can be searched to identify other failure that are applicable to the systems.

STEP 8: FIND THE POSSIBILITY OF GRROWING THE TREE

Search through failure tree of biomass bioler for possibility of producing other IEs, MSs or HESs using already identified IEs, MSs, and HESs in a scenario tree. ARIZ and SIVAI-TRIZ are very useful for this particular purpose. Scenario tree of biomass boiler is as shown below.

$IE_{r1} \rightarrow MS_{b1} \rightarrow MS_{e1} \rightarrow MS_{z1} \rightarrow HES_{r1}$

$IE_{p1} \rightarrow MS_{w1} \rightarrow MS_{b1} \rightarrow MS_{e1} \rightarrow MS_{z1} \rightarrow HES_{r1}$

$IE_{r2} \rightarrow MS_{v1} \rightarrow MS_{e2} \rightarrow MS_{z2} \rightarrow HES_{r2}$

$$IE_{v2} \rightarrow MS_{w1} \rightarrow MS_{b2} \rightarrow MS_{b3} \rightarrow MS_{e2} \rightarrow HES_{r3}$$

$$IE_{w2} \rightarrow MS_{f1} \rightarrow MS_{b1} \rightarrow MS_{e1} \rightarrow MS_{z1} \rightarrow HES_{r1}$$

$$IE_{e1} \rightarrow HES_{r3}$$

$$IE_{w2} \rightarrow MS_{v3} \rightarrow MS_{f2} \rightarrow MS_{b1} \rightarrow MS_{e1} \rightarrow MS_{z2} \rightarrow HES_{r1}$$

$$IE_{c1} \rightarrow MS_{f2} \rightarrow MS_{b1} \rightarrow MS_{e2} \rightarrow MS_{z2} \rightarrow HES_{r2}$$

$$IE_{f1} \rightarrow MS_{h1} \rightarrow MS_{e2} \rightarrow HES_{r2}$$

$$IE_{d1} \rightarrow MS_{f2} \rightarrow HES_{r3}$$

STEP 9: INTENSIFY AND MASK HARMFUL EFFECT

This is technical. Importance of this step is to find failures that appear as function of time or worsen as system functions in time.

STEP 10: ORGANIZE THE SCENARIO TREE

Find root causes of each IE, MS and HES. Organize the scenario tree.

7.3 Failure in Complex Manufacturing System

Technicians that are responsible for servicing aircraft engine complained of frequent formation of crystals in aircraft engines which were recently dispatched to their company. They would have thought that the problem was due to impurity of jet fuel, but all customers who purchased the same aircraft observed the same problem and made complaints to industry that manufactured it. In order to allay wide spread of fear, the industry is facing big challenge in finding root cause of the problem.

7.3.1 Application of SIVAI-TRIZ based AFD-3

STEP 1: FORMULATE THE PROBLEM

787 gas engines is a system that powers Boeing 787 Dreamliner; it is compact structure that comprises fuel tank, fuel pumps, filter and injector. It was manufactured on 14th February and dispatched to customers on 30th April, 2012, but those customers called and made complaints of white formation of crystal in the engine system.

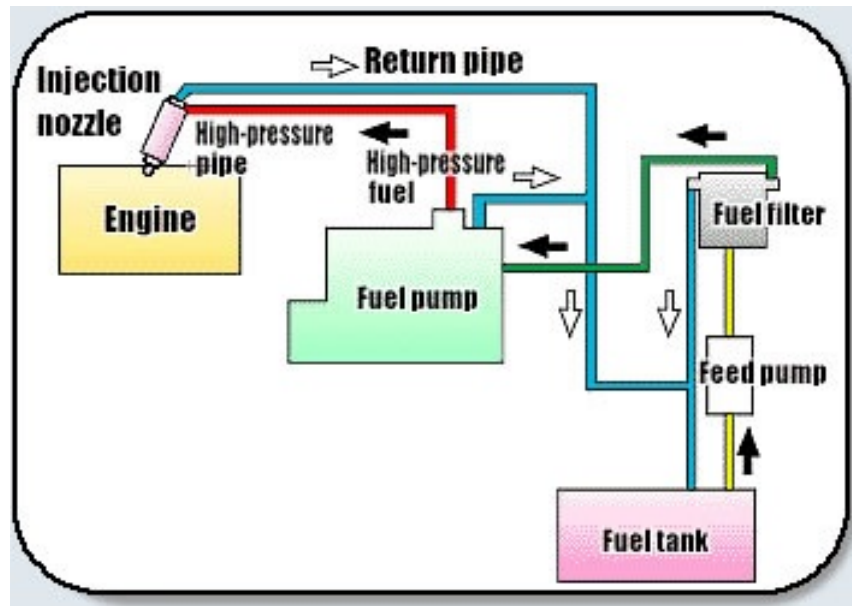

FIGURE 7.4: Schematic of Aircraft Fuel System [9]

STEP 2: IDENTIFY SUCCESS SCENARIOS

Subsystem	Success Scenario
Fuel Tank	Stores fuel
Feed Pump	Transfers fuel to filter
Fule Filter	Isolates impurities and transfers fuel to fuel pump
Fuel Pump	Transfers fuel to injection nozzle
Injector	Mixes fuel with air and feeds engine
Engine Block	Powers aircraft body

STEP 3: LOCALIZE THE FAILURE**STEP 3.1: Map System Dependency to DSM**

This step is same as in AFD-1; map interactions at subsystem level to DSM matrix and localize failure. The failure can be localized in DSM by analyzing interactions with respect to function of subsystem and its output (success scenario). For example, there is formation of white crystal in the engine system indicates that the problem may emanate from fuel filter.

Step 3.2: Identify the Failure

As shown in DSM matrix, the failure is localized at filter in subsystem level of the engine fuel system. Further, fuel filter can be decomposed to localize the failure at component level. A number of DSM mapping required to localize failure at component level depends on system architecture.

	Fuel Tank	Feed Pump	Fuel Filter	Fuel Pump	Injector	Engine Block
Fuel Tank	X	O	X	X	X	O
Feed Pump	X	X	O	O	O	O
Fuel Filter	O	X	X	O	O	O
Fuel Pump	O	O	X	X	O	O
Injector	O	O	O	X	X	O
Engine Block	O	O	O	O	X	X

STEP 4: FORMULATE THE PROBLEM AT SUBSYSTEM LEVEL

Fuel filter is a subsystem in aircraft engine, which separates contaminants and impurities from fuel that flows to engine block. The fuel allows white crystals which accumulate in the engine system. Visual analysis and technical examination indicate that this failure appears under intended conditions for which the filter is designed.

STEP 5: STATE SUCCESS SCENARIOS AT SUBSYSTEM LEVEL

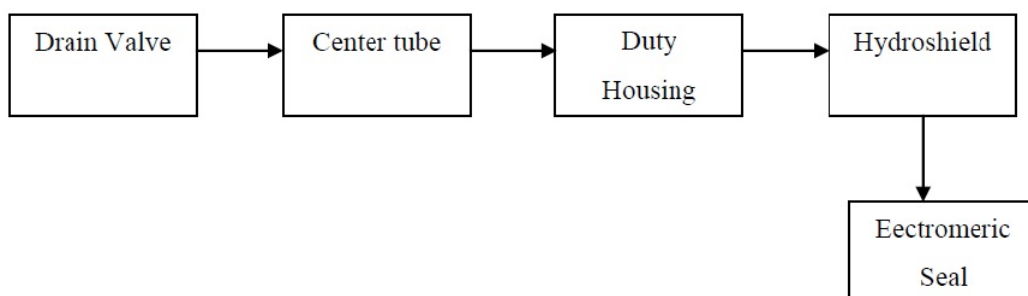

FIGURE 7.5: Exemplary Block Diagram of Fuel Filter

Subsystem	Sucess Scenario
Electromeric Seal	Provides positive sealing
Hydroshield	Repels water and other contaminants
Duty Housing	Provides unequal burst and pulse
Centertube	Prevent system collapse
Drain Valve	Provides compatibility

STEP 6: LOCALIZE THE FAILURE AT COMPONENT LEVEL

Interactions in figure 7.5 are mapped to DSM and the failure is localized as shown in the below depicted DSM. The failure is localized at the basic element of aircraft engine fuel system; thus, the next approach is consulting design archives (records).

	Drain Valve	Center Tube	Duty Housing	Hydroshield	Electromeric Seal
Drain Valve		O	O	O	O
Center Tube	X		O	O	O
Duty Housing	O	X		O	O
Hydroshield	O	O	X		O
Electromeric Seal	O	O	O	X	

STEP7:GATHER REQUIRED INFORMATION

Step 7.1: Consult Design Document

The proper document to look for in this step is design matrix (DM) of axiomatic design. Let us suppose that the design structure matrix of the basic element 'hydroshield' is 3-by-3 order matrix shown below.

	DP_1	DP_2	DP_3
FR_1	O	X	X
FR_2	X	O	X
FR_3	X	X	O

Step 7.2: Map DM Information to DSM

Perform matrix permutation on the DM matrix or use relationship among output variables and dependent variables to map DM to DSM matrix. Method of mapping DM to DSM matrix is explained in chapter 3.

First approach: choose output variables in the DM matrix such that each output variable occupies only a row and column of DM matrix.

	DP_1	DP_2	DP_3
FR_1	O	X	\boxed{X}
FR_2	\boxed{X}	O	X
FR_3	X	\boxed{X}	O

Second approach: Find a unique permutation matrix such that performing row permutation on the DM matrix with the permutation matrix moves chosen output variables to the diagonal of the matrix; the permutation matrix for the 3-by-3 order DM matrix:

$$Permutation_{matrix} = \begin{bmatrix} 0 & 1 & 0 \\ 0 & 0 & 1 \\ 1 & 0 & 0 \end{bmatrix}$$

	DP_1	DP_2	DP_3
DP_1	O	X	\boxed{X}
DP_2	\boxed{X}	O	X
DP_3	X	\boxed{X}	O

Third step: perform matrix row permutation to obtain the information flows in the right order (in DSM matrix) by multiplying columns of DM matrix with rows of permutation matrix using equation 3.11. The matrix shown below is obtained DSM matrix of the design parameters. The transformation method was started with design matrix (DM) of axiomatic design and ended with design structure matrix (DSM) of design parameter (DPs) shown below.

	DP_1	DP_2	DP_3
DP_1	X	O	X
DP_2	X	X	O
DP_3	O	X	X

STEP 8.0: LOCALIZE THE FAILURE AT DP LEVEL

DSM matrix of design parameters is obtained in step 7 using transformation method. Use the DSM matrix of DPs to localize failure at DP level through analyzing interactions among DPs. The source of problem is DP_2 as indicated below in DSM with red color.

	DP_1	DP_2	DP_3
DP_1		O	X
DP_2	X		O
DP_3	O	X	

STEP 9.0: LOCALIZE THE FAILURE PROCESS LEVEL

The DP_2 can be used in this step to trace manufacturing process of manufacturing system that generated it. Design archives can be consulted to find out manufacturing process from which the DP is generated. Root causes of the DP problem lie in the process.

STEP 10: FORMULATE, INVERT, AND AMPLIFY THE PROBLEM

This step is same as in AFD-1. How to invert and amplify a failure or problem is well explained in first example.

STEP 11: SEARCH FOR SOLUTION

This is same as in AFD-1. An important information to keep in mind is that resources for synthesizing a problem can include tools, technical decision, organizational decision, processes, raw materials, et cetera which are used to generate a DP in manufacturing process.

STEP 12: FORMULATE HYPOTHESIS AND VERIFY IT

The same as in AFD-1 example.

STEP 13: IMPLEMENT MEASURE FOR THE PROBLEM

The same as in AFD-1 example.

7.4 Summary and Conclusion

In chapter 1, thesis background, purpose, and problem statement are presented and explained which set the direction of this thesis research. The background shows importance of employing system engineering concepts to improve capability of AFD methods.

Concepts of AFD templates that are developed by Stan Kaplan et al are presented in the chapter 2. The shortcomings of the AFD methods and solution by which they can be averted are explained and presented in chapter 3.

In chapter 4, SIVAI-TRIZ based AFD-1 is developed which takes system interactions and system emergent behaviors into consideration. SIVAI-TRIZ based AFD-1 has capability which can be used to improve system safety and reliability because system engineering tool such as design structure matrix is embedded in the method. Also, this modified AFD-1 is technically suitable to develop database of past failures and aid future system design because it embodies system engineering concepts which makes it good candidate for system modeling.

SIVAI-TRIZ based AFD-2 is developed in chapter 5. This newly modified AFD-2 has capability which can be used to predict system future failures based on vector flows, architecture, and system emergent behaviors. It is technically suitable for conceptualization and design because its template embodies system interaction, vulnerability analysis, and differential vulnerability.

In chapter 6, AFD-3 is created to capture failure due to human error and poor ergonomic design. Particularly, this tool is specially developed to reveal root causes of product failure in a manufacturing system from which it is generated. It draws relationship between details of design concept and system emergent properties through mapping DM information to DSM information using transformation method.

In chapter 7, practical examples are used to illustrate SIVAI-TRIZ based AFD-1 method; SIVAI-TRIZ based AFD-2 method, and AFD-3. The problems that are

used to exemplify SIVAI-TRIZ AFD concepts are not real-life problem, but they are intuitively fabricated to match real-life problem.

7.5 Future Work

Recommended work includes applying the methods to real-life problems and creating software that can aid in using these methods to solve engineering problem. Application of SIVAI-TRIZ AFD methods to real-life engineering problem will reveal difficulty that may be faced in using them to solve industry problems. Their applications to many industry problems are crucial to ascertain their technical strengths and weakness based on practicalities. Software system that is based on I-TRIZ body of knowledge should be updated to accomodate SIVAI-TRIZ body of knowledge.

Appendix A

Appendix A

Fundamentals of the two modified AFD methods and AFD-3 are TRIZ (theory of inventive problem solving), design structure matrix (DSM), and transformation method. In this appendix A, TRIZ principles, DSM matrix, and transformation method are thoroughly explained in simplest way that facilitates understanding of those two modified AFD methods and AFD-3 method. It is important to grasp the fundamentals that are explained in this appendix A to know how to use modified AFD-1 template, modified AFD-2 template, and AFD-3 template to solve system problem.

A.1 Theory of Inventive Problem Solving (TRIZ)

The early father of TRIZ is Genrich Altshuller, who was a Russian citizen. At the end of Second World War, Genrich Altshuller started working as patent approving agent in the department of navy in old Soviet Union. While working as patent examiner, he made three discoveries on which invention and development of TRIZ over fifty years depend. Genrich Altshuller catalogued patents submitted for examination, analyzed them, and discovered that there are similar patterns of solutions to similar problems for first discovery. As result of this, he postulated there is possibility of creating mechanism that defines a problem type and mapping the problem type to its solution type in solution space. In furtherance, he also analyzed evolution of chronologically evolving technology and discovered regularities. He referred to “such time-based” evolution of technology as eight laws of engineered system. This discovery is applied in different disciplines that range

from product development to innovation. Applicability of this discovery is due to revelation that chronologically evolving technology is derivative. Derivative in the sense that a point in the chronological order of evolving technology determines what can be done to create next new product or innovation. Genrich Altshuller's first discovery and derivative nature of chronologically evolving technology makes innovation and development of I-TRIZ tools possible.

A.1.1 Principles of TRIZ

The basic components of TRIZ principle are ideality principle, principle of contradictions, and principle of maximal use of resources. These three principles are basic elements that determine analytical approach of AFD. They are detailed to an extent in the following to give glimpses of their concepts which are important to understand the main part of this thesis work.

A.1.2 Ideality Principle

Ideality principle is at the first level of TRIZ mechanized structure for solving specific inventive problem as it serves as a pointer that points to desired state of a system with which can be used to reveal resources and conditions for reaching a state. Notion of ideality principle is even embedded in man's daily routines and can be equated with common belief that if one knows where one is going one will definitely know what can be used and how to get there; for instance, if one's ideal place for tourism is United States, one need different resources from someone whose ideal place of tourism is Canada. In context of the example, it is philosophically accurate to think about such journey as a system because it does not only depend on time, but it normally has one or more transits which can be seen as phases. Ideality principle narrows focus on resources that are required to reach a phase such as time, distance, space in the flight, petrol gas, automobile and aircraft as in case of example "if one knows where one is going, one will definitely know what can be used and how to get there."

Ideality principle postulates that ideal state increases as a system functions over a time interval. Ideality is ratio of useful functions to harmful function [10].

$$I = f(t, F_U, F_H) \quad (\text{A.1})$$

Useful function, F_U , is set of desired functions of a system. According to ideality principles, desired function converges to extreme state of ideality as a system transverse its phases over time. Harmful function, F_H , comprises a set of undesired attributes, properties, costs et cetera. F_H is a function of time as its counterpart. Ideality can be mathematically expressed as ratio of useful function of time to harmful function of time.

$$I = \frac{F_U}{F_H} \quad (\text{A.2})$$

As denoted in the equation, ideality goes to extreme limit when harmful function is reduced, which is main goal of risk science. Ideality principle is used in AFD approach to narrow area of analysis in order to identify system resources to reveal a failure scenario.

A.1.3 Principle of Maximal Use of Resources

Another basic principle of TRIZ is maximal use of resource. Principle of maximal use of resource is related to ideality principle because an ideal state determines resources that are required to reach a state. Principle of maximal use of resources and ideality principle exhibit same truism though they tackle AFD problem from opposite directions. Principle of maximal use of resources tackles AFD problem from left to right, but ideality principle tackles problem from right to left. Both principles are pivotal for analytical approach of revealing failure scenario using AFD method.

Principle of maximal use of resources states that an ideal state can only be reached if and only if required resources to reach a state are present. For example, one cannot reach one's ideal place of tourism without aircraft, automobile, petrol as in the example "if one knows where one is going, one will definitely know what can be used and how to get there."

A.1.4 Principle of Contradiction

Principle of contradictions is way of finding uncompromised solution to inventive problem. In solving inventive problem, principal aim is to identify technical contradiction and physical contradiction and find a solution that resolves both contradictions. Solution that resolves both contradictions is uncompromised solution to a specific inventive problem.

Technical contradiction refers to situation in which two parameters are conflicting; for example, problem of mass verses strength in bridge construction. The desire attributes is to have as lower mass of material as possible, but higher strength of material, which are conflicting since increasing mass is enhancing strength of material.

Physical contradiction refers to a situation in which a parameter satisfies oppositeness of two conflicting parameters. Finding a parameter that satisfies physical contradiction is finding solution to technical contradiction.

Principle of contradiction states that uncompromised solution to specific inventive problem can be devised by solving inherent technical contradictions and physical contradictions of a system.

A.2 AFD Thought-Process Cycle

Anticipatory failure determination is RA approach that is oriented in the direction of failure inventiveness. The philosophy of orienting AFD to this direction is due to shift in paradigm of risk science. The paradigm maintains and stresses that failure scenario can be accurately revealed if it is produced rather than stated using physical attributes of a failure. The paradigm is reflected in AFD by basing thought process on theory of inventive problem solving (I-TRIZ), which makes AFD better tool for risk analysis and risk prediction. Strength of I-TRIZ lies in ideality concept, technical contradiction, physical contradiction, and maximal use of resources.

AFD thought-process cycle is based on solution by abstraction, which involves series of mapping from one abstraction to another. This cycle encompasses mapping reformulated problem to its problem abstract category, mapping problem abstract

category to its solution abstract category, and using solution abstract category to specialize the solution. The thought-process cycle continues until specialized solution is found. The diagram below depicts the thought process cycle at glance [10].

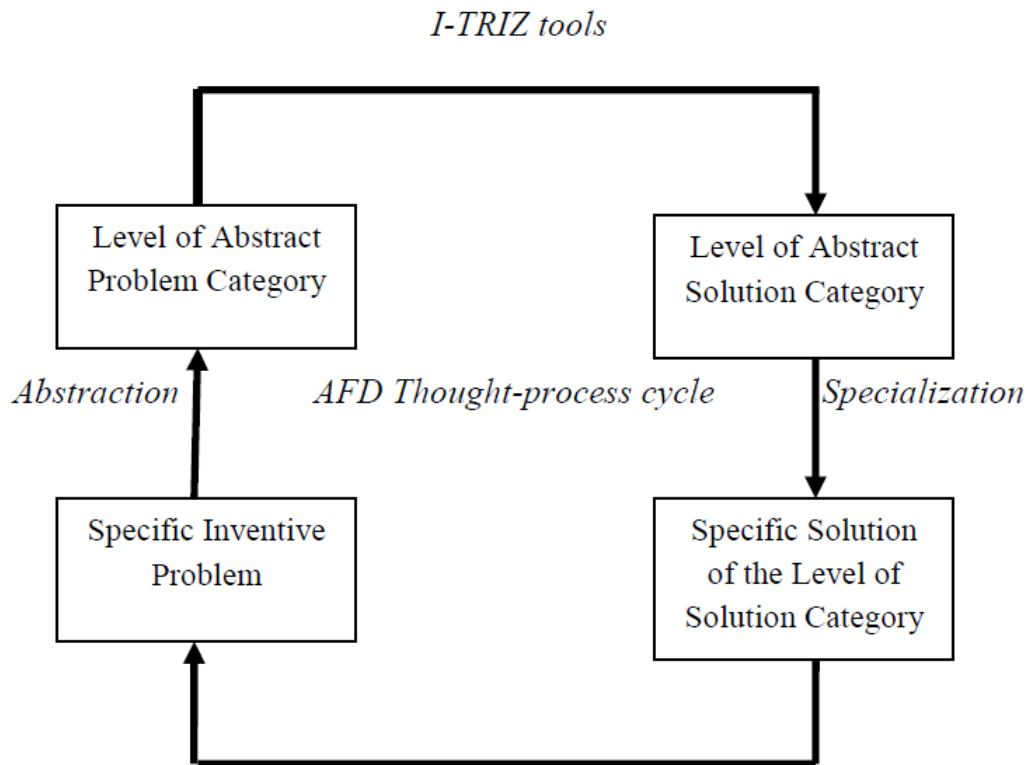

FIGURE A.1: Generic Solution by Abstraction [10]

The first step of AFD thought-process cycle is finding specific problem and making it inventive; for example the specific problem can be failure of a system or encountered problem in one or more phases of an activity. The specific problem must be made inventive by inverting it in such way that it can be synthesized rather than observed and stated; for instance, if failures of a system have been identified as camshaft crack and noisy break system, the failure can be made inventive problem as thus:

It is important to produce failure of camshaft using available resources and condition that accompanies the failure.

It is important to produce failure of noisy break system using available resources and condition that accompanies the failure.

Stating the problem of the failure as showed above shifts attention from stating root causes of failure using physical attribute to creating a failure and revealing its scenario using physical attribute of the problem and resources.

The second step of the thought-cycle process is mapping the specific inventive problem to its problem abstract category. Scientifically and analytically, it is believed that every problem belongs to a problem abstract category. In mathematical language, problem abstract category is superset of analogous problems which are characterized by attributes of a problem abstract category in problem space. The essence of this mapping to problem abstract category is to identify and provide analogous attributes with which solution abstract category of specific inventive problem can be identified; then available information and resources which are required can be easily flushed out.

Third step of the thought process is mapping the already identified problem abstract category to its solution abstract category in problem space. Philosophical thinking in step two is analogous with that of step three because it is believed that every problem abstract category has its distinct solution abstract category in solution space either. Main reason for identify solution abstract category in solution space is to identify analogous attributes of solution abstract category to which the problem abstract category belongs, which will reveal what are required to solve an inventive problem.

In the fourth step, analogous attributes of solution abstract category is used to specialize specific solutions to specific inventive problem solving. Attributes of specific inventive problem is compared against analogous attributes of solution abstract category to specialize solutions to its inventive problem. Typical example of this thought process is method of solving differential equations in various engineering disciplines. This is illustrated in figure [A.2](#).

In figure [A.2](#), AFD thought-process cycle can be likened to method of solving differential equations. In solving differential equations, most crucial pieces of information are equation itself, boundary conditions, and independent variables. The same can be thought about AFD approach because it is isoperimetric with differential equations. These two methods are isoperimetric because there is always condition that accompanies a system failure which defines failure boundary

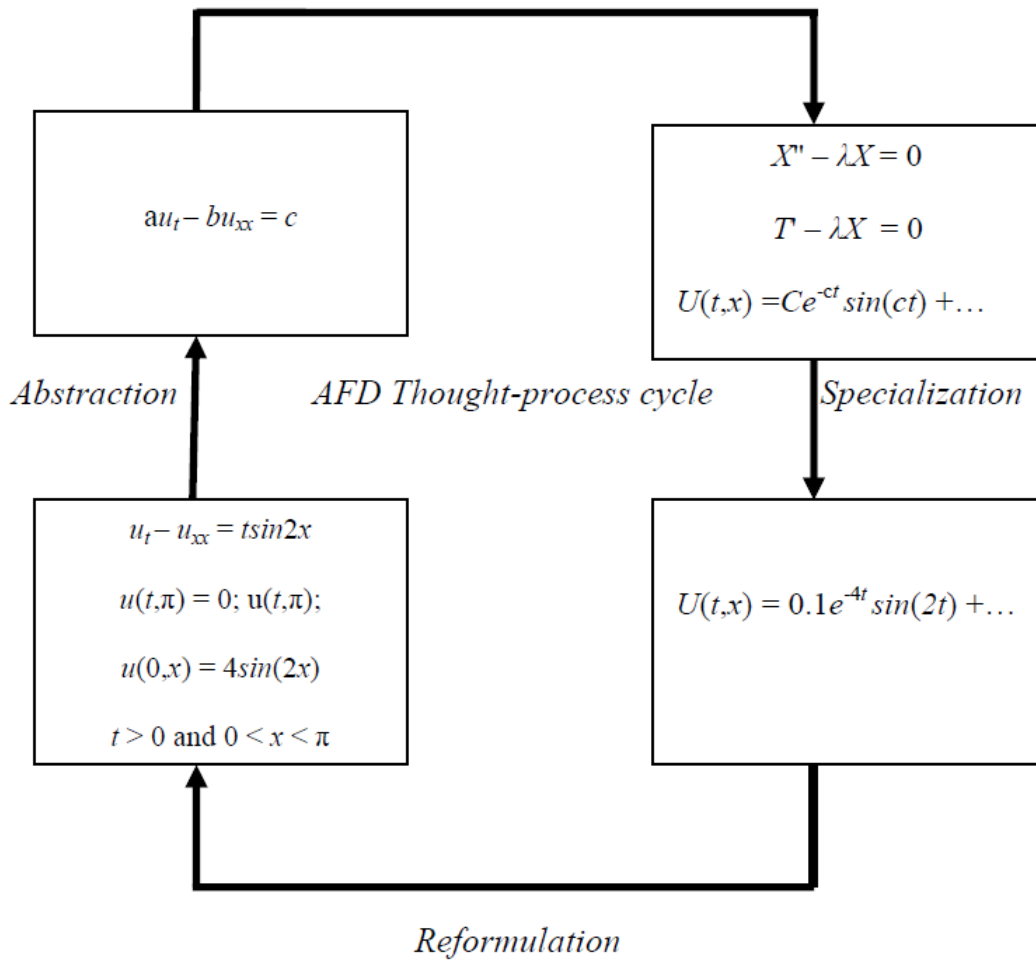

FIGURE A.2: Solution by Abstraction Using Differential Equation

and its resources. Resources can be likened to independent variables of differential equations in this context in order to understand similarities between both methods.

As in first step of solving differential equation, equation is formulated and boundary conditions and limits of independent variables are stated. This is likened to AFD approach because failure is formulated and resources within the vicinity at which the failure occurred are surveyed. Formulation of the problem and survey of resources defines attributes of failure.

As illustrated in the step two of figure A.2, the equation, $u_t - u_{xx} = t \sin 2x$, is mapped to its abstract problem category, $au_t - bu_{xx} = c$. This step is accomplished in AFD method by inverting a problem so that risk analysis is focused on how to produce the failure rather than state solution using physical attributes.

In step three, problem abstract category, $u_t - u_{xx} = c$, is mapped to its solution abstract category $U = e^{-ct} \sin ct$. In AFD method, this step is accomplished by identifying a branch of studies, engineering, sciences, et cetera in which a phenomenon of failure is intentionally synthesized. Identifying where such phenomenon is produced narrows area of analysis and shows how such failure can be produced.

In the fourth step of figure A.2, coefficients of the equation of the solution abstract category, $U = ce^{-ct} \sin ct$ are determined by using boundary conditions and independent variables of the equation and comparing with attributes of its abstract solution category for solution specialization. Process of finding numerical values of coefficients of differential equation is known as specialization of solution abstract category to inventive problem. In AFD method, this step is accomplished by using resources and parameters of conditions which accompanies failure to resolve its contradictions.

In this appendix, origin of TRIZ, TRIZ principles, basic elements of TRIZ and AFD-thought process cycle are already explained to an extent which is sufficient to grasp new approaches are presented in the thesis. The glimpse of AFD method introduced in here is provided to show that modified AFD-1, modified AFD-2 and new created AFD-3 retain philosophy on which AFD method is built, but provide better framework for analyzing, predicting and revealing failure scenarios.

A.3 Design Structure Matrix(DSM)

DSM is N^2 -matrix tool that is used in system engineering to capture system interactions. In recent years, DSM is increasingly used in system engineering because system behaviors are largely determined by interactions of its constituents. In DSM matrix, number of rows and columns are equal which are required to ensure that DSM captures totality of system behaviors and interactions. Information flows can be represented in DSM matrix in such a way that they either flow from a column across rows of the matrix or flow from a row across columns of the matrix. Those two ways of representing information flow provide same results. For example, information flow in a system can be mapped to DSM as thus: information flow from component A to component B can be represented in A column and C row of DSM matrix; information flow from B to C can be represented in B column and

C row; information flow from C to D can be represented in C column and D row. This way of representing system interactions in DSM matrix can be called column-to-row information flow since information flows from a column through rows of the matrix. Knowing how information flows in DSM matrix that represents system behavior is good technical approach to localize a system failure and predict system future failures. The Information flows in system block diagram shown in figure A.3 is represented in the following DSM matrix.

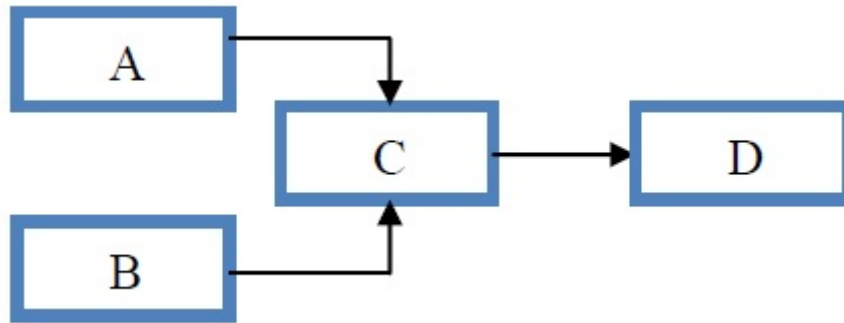

FIGURE A.3: System Block Diagram

	A	B	C	D
A		O	O	O
B	O		O	O
C	X	X		O
D	O	O	X	

The matrix can be changed to numerical DSM by replacing 'X' with numerical value '1' and 'O' with 0 as shown below for figure A.3.

	A	B	C	D
A	1	0	0	0
B	0	1	0	0
C	1	1	1	0
D	0	0	1	1

In a system, there are different kinds of flow due to technical needs and inputs which are taken into consideration during design; for example, energy transfer from component A to component B is required in power system design; temperature flow from component A to component B is required in gas turbine system design.

Knowing component functions and flows between two components is essential to use DSM to localize system failure. The different kinds of flow due to technical needs and inputs in a system are summarized in the following table.

Interaction	Description	Flow
Spatial	Adjacency or orientation between A and B	
Energy	Energy transfer from A to B	$A \rightarrow B$
Information	Informaion flow from A to B	$A \rightarrow B$
Material	Material transfer from A to B	$A \rightarrow B$
Mechanical steady state	A and B are in physical contact and imposed steady steady	$A \leftrightarrow B$
Mechanical dynamics	A and B are in contact and interact by force	$A \leftrightarrow B$
Thermal dynamics	Fluctuating difference between A and B	$A \rightarrow B$
Thermal steady State	There is steady state difference in temperature between A and B	$A \rightarrow B$
Electrical Signal	Signal flow from A to B	$A \rightarrow B$
Electrical earth	Electrical earth connection between A to B	$A \leftrightarrow B$
Electrical dynamics	Logical behavior of A is connected to that of B	$A \rightarrow B$

A.4 How to Use DSM to Predict Failures

Flow of resources and relationships between two components in DSM matrix are two most important details of the matrix, which are essential to either localize failure or predict future failures of a system. Because of importance of flow in use of DSM, some kinds of flow which often occur in a system are summarized in the table above though there are others that can come up when risk analysis or risk prediction of complex system is performed. DSM matrix traps flows and component relationships which define system behaviors when flows are appropriately represented in the matrix. As such, defining relationships between two components and stating flows of resources while performing risk analysis or risk prediction are very important to localize failure or predict future initiating events (IEs), middle states (MDs), and end states (ESs) using the matrix. The following digraph in figure A.4 and its DSM matrix can be used to demonstrate how to use DSM to predict failures.

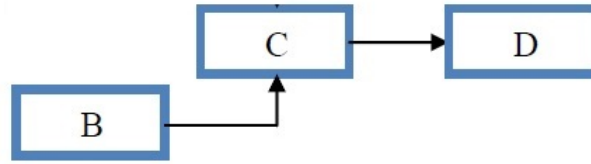

FIGURE A.4: Simple Block Diagram

	<i>B</i>	<i>C</i>	<i>D</i>
<i>B</i>	1	0	0
<i>C</i>	1	1	0
<i>D</i>	0	1	1

Step 1: Identify Flow Paths in DSM

In DSM matrix of a system, one or more flow paths can be present; identify the flow paths, define flow of resources, and archive them. For example flow path of DSM matrix for the figure A.4 is: $B \rightarrow C \rightarrow D$. It is important to note that information flows from column across rows in the DSM matrix.

Step 2: Identify and Archive Failures of Components on the Flow Paths

In this step, start with least dependent component and find all possible failures that can appear in the component; for example, find possible failures that can appear in component *B*, component *C*, and component *D*. The possible failures that can occur in component *A*, component *B*, and component *C* can be regarded as initiating events (IEs) of the system. In DSM of figure A.4, degree of dependency can be summarized as thus: *B* has least dependency, component *C* has less dependency, and component *D* has little dependency in the flow path.

Step 3: Identify Effects of IEs and MSs on Subsequent Component

Analyze, identify, and state effects of failures that can appear in each component on subsequent component. Identifying effect of failures on subsequent component must be started with least dependent component in a flow path. For example, effects of failures (in *B* component) on *C* component are possible mid states (MDs) at that level of the flow path. Further Analyze and state effects of those mid states (at *C* component level) on the component *D*. The effects of middle states (at *C* component) on the component *D* can be archived as the possible end states (ESs)

of the flow path ($B \rightarrow C \rightarrow D$) since component D is last component of the flow path.

Further, analyze and state effect of failures that can appear in C component on the D component. Also, those effects of failures (IEs of component C) on D can be archived as end states (ESs). Method of using DSM to predict future failures is iterative and it must be performed with respect to degree of component dependency in a flow path.

Summarily, the three steps can be simplified as thus:

For every flow paths in DSM, analyze, identify failures that can appear in each component, and archive those failures as initiating events; for example, the exemplary DSM has B component, C component, and D component. State sets of failures that can appear in those three components as: $\{IE_{bi}\}$, $\{IE_{ci}\}$ and $\{IE_{di}\}$ and use those sets of initiating events to iterate through the identified DSM flow paths to reveal middle states ($\{MS_i\}$), and end states ($\{ES_i\}$).

First iteration

Identify effects of $\{IE_{bi}\}$ on its subsequent component, archive those effects as mid states ($\{MS_{ci}\}$); then identify effects of $\{MS_{ci}\}$ on subsequent component. For example, identify effects of $\{IE_{bi}\}$ on C , archive those effects as middle states ($\{MS_{ci}\}$) at C -component level of the flow path; then, identify effects of the mid states ($\{MS_{ci}\}$ on D component. The effects of $\{MS_{ci}\}$ on D component can be archived as end states ($\{ES_{1di}\}$).

Second iteration

Identify the effect of $\{IE_{ci}\}$ on D component in the flow path and archive them as end states ($\{ES_{2di}\}$).

Third iteration

The failure that appear in component D can be archived as end state ($\{ES_{3di}\}$) since it is last component in the flow path. These steps can be used to identify $\{IE_i\}$, $\{MS_i\}$, and $\{ES_i\}$ in n -component flow path of DSM matrix:

$A \rightarrow B \rightarrow \dots \rightarrow N$.

This method of using DSM to predict failures has potential of predicting all possible system failures when resources that flow through each path of a system represented in DSM matrix are considered.

A.5 Transformation Method

Transformation method is a method that is used to transform design matrix (DM) of axiomatic design to design structure matrix (DSM). This method is very important to understand and apply AFD-3 method to risk analysis, which is the reason it is re-emphasized on in this appendix. Transformation of DM to DSM involves three important steps which are illustrated in the following using DM matrix.

	DP_1	DP_2	DP_3
FR_1	X	O	X
FR_2	O	X	X
FR_3	X	X	O

First step: choose output variables in DM matrix such that one output variable occupies one row and one column of a DM matrix. For example, the output variables are chosen in the DM matrix as shown below.

	DP_1	DP_2	DP_3
FR_1	X	O	\boxed{X}
FR_2	O	\boxed{X}	X
FR_3	\boxed{X}	X	O

Second step: Perform row permutation on the DM matrix (with chosen output variables) in such a way that chosen output variables occupy diagonal of DSM matrix. For example, permutation matrix for above DM matrix is shown below.

$$Permutation_{Matrix} = \begin{bmatrix} 0 & 0 & 1 \\ 0 & 1 & 0 \\ 1 & 0 & 0 \end{bmatrix}$$

Third step: Permute the rows of the DM matrix by multiplying columns of DM matrix (with chosen output variables) with rows of permutation matrix. This is expressed in equation 3.11.

	DP_1	DP_2	DP_3
DP_1	\boxed{X}	X	O
DP_2	O	\boxed{X}	X
DP_3	X	O	\boxed{X}

Appendix B

Appendix B

B.1 Code Used for Simulation

```
% A piece of code used to simulate singular modularity equation.  
% It is just implemented to test SMI model,  
% not to be used as software for solving industry problem.
```

```
#include<stdio.h>  
#include<math.h>  
#define SIZE 2000  
#define ZERO 0  
#define ONE 1  
#define OUTPUT printf  
#define INPUT scanf  
#define HOLD_MATISSA float  
#define HOLD_INT int  
  
int main() {  
  
    HOLD_MATISSA E_VALUE[SIZE] = {0.00};  
    HOLD_MATISSA S_VALUE[SIZE] = {0.00};  
    HOLD_MATISSA D_VALUE[SIZE] = {0.00};  
    HOLD_MATISSA ARRAY[SIZE] = {0.00};  
    HOLD_MATISSA CUMU = 0.000;  
    HOLD_MATISSA ARGMIN[SIZE];  
    HOLD_INT i = ZERO;  
    HOLD_INT j = ZERO;  
    HOLD_INT COUNTER = ZERO;  
    HOLD_INT MATRIX_SIZE = ZERO;  
    HOLD_INT ALPHA = ZERO;  
  
    OUTPUT("\n MATRIX SIZE:");  
  
    INPUT("%i",&MATRIX_SIZE);
```



```

for (i = ONE; i <= MATRIX_SIZE; i++){
    OUTPUT("\t");
    OUTPUT("S[%d]:", i);
    INPUT("%f", &E_VALUE[i]);
    ++COUNTER;
    (S_VALUE[i]= (pow(E_VALUE[i],0.5)));
}

// sorting of the matrix in ascending order.

for(i=ONE;i< COUNTER;i++) {
    for(j=ZERO;j< COUNTER-1;j++)
        if(S_VALUE[j]>S_VALUE[j+1])
            {
                // double temp = ZERO;
                HOLD_MATISSA temp=S_VALUE[j];
                S_VALUE[j]=S_VALUE[j+1];
                S_VALUE[j+1]=temp;
            }
}

//OUTPUT(" \n %f", S_VALUE[1]);
//OUTPUT(" \n %f", S_VALUE[2]);
//OUTPUT(" \n %f", S_VALUE[3]);
//OUTPUT(" \n %f \n", S_VALUE[4]);

// Implementation of Singular Modularity Index

OUTPUT("ALPHA SIZE:"); // Number of step of alpha
INPUT("%d", &ALPHA);

for(i = ZERO; i < ALPHA; ++i){
    OUTPUT("ALPHA[%d]:", i);
    INPUT("%f", &ARRAY[i]);
}

for(i = ZERO; i < ALPHA; ++i){
    CUMU = 0.00;
    for (j = ONE; j <= COUNTER; ++j){
        HOLD_MATISSA CONST = S_VALUE[j]/S_VALUE[COUNTER];
        HOLD_MATISSA EXP = exp(-(j-1)/ARRAY[i]);
        if ((CONST-EXP) < ZERO){
            CUMU+= ((-1.00)*(CONST-EXP));
        }
        else{
            CUMU +=(CONST-EXP);
        }
    }
    ARGMIN[i] = CUMU;
}

for(j = ZERO; j < ALPHA; ++ j){
    OUTPUT("\n ARGMIN[%d]: ", j);
    OUTPUT("%f", ARGMIN[j]);
}

```

```
}  
  
OUTPUT("\n\n");  
  
system("pause");  
  
return(ZERO);  
}
```

Bibliography

- [1] Kaplan S., Zlotin B., and et al. *New tools for failure and risk analysis: an introduction to anticipatory failure determination (AFD) and the theory of scenario structuring*. Ideation International, 1999.
- [2] Hölttä O., de Weck O., and et al. Degree of modularity in engineering systems and products with technical and business constraints. *Concurrent Engineering*, 15(2):113–126, 2007.
- [3] Turner B. and Roger E. A framework for vulnerability analysis in sustainability science. *Proceedings of the national academy of sciences*, 100(14): 8074–8079, 2003.
- [4] Tauristercus. Launching stages of rocket. <http://www.abovetopsecret.com/forum/thread579277/pg10/>. Accessed May 12, 2014.
- [5] Suh N. Introduction to axiomatic design. http://ocw.mit.edu/courses/mechanical-engineering/2-800-tribology-fall-2004/lecture-notes/ch10_axiomatic.pdf/. Accessed May 12, 2014.
- [6] Dong Q. *Predicting and managing system interactions at early phase of the product development process*. PhD thesis, Massachusetts Institute of Technology, 2002.
- [7] Anonymous. Analysis of concept design, mechanism, and operation of radiation pyrometer. <http://www.globalspec.com/reference/10956/179909/chapter-7-temperature-measurement-radiation-pyrometers/>, . 2014.
- [8] Anonymous. Simplest pressurized storage solution for biomass boilers for home use "practical energy management". <http://www.hearth.com/talk/wiki/pressurized-storage-solution-for-biomass-boilers/>, . 2014.

-
- [9] Denso P. Pump – diesel fuel injection. <http://www.denso.com.sg/index.php/products/pump/diesel-fuel-injection/>. Accessed May 12, 2014.
- [10] McMunigal J., Ungvari E., and et al. Triz. *Mechanical Engineers' Handbook: Materials and Mechanical Design, Volume 1, Third Edition*, pages 612–641.
- [11] Neil W. Vulnerability. *Global environmental change*, 16(3):268–281, 2006.
- [12] Füssel, Hans-Martin, and et al. Vulnerability: a generally applicable conceptual framework for climate change research. *Global Environmental Change*, 17(2):155–167, 2007.
- [13] Gallopín and Gilberto C. Linkages between vulnerability, resilience, and adaptive capacity. *Global Environmental Change*, 16(3):293–303, 2006.
- [14] Yassine A. An introduction to modeling and analyzing complex product development processes using the design structure matrix (dsm) method. *Urbana*, 51(9):1–17, 2004.
- [15] Steward D. The design structure system: a method for managing the design of complex systems. *Engineering Management, IEEE Transactions on*, (3): 71–74, 1981.
- [16] Lieke C., Magdalena K., and et al. Modularization method for adaptable products. In *ASME 2008 International Design Engineering Technical Conferences and Computers and Information in Engineering Conference*, pages 193–202. American Society of Mechanical Engineers, 2008.
- [17] Ahmed K., Sandra L., and et al. Reanalysis procedure for large structural systems. *International journal for numerical methods in engineering*, 26(8): 1729–1748, 1988.
- [18] Bartolomei E. Qualitative knowledge construction for engineering systems: extending the design structure matrix methodology in scope and procedure. Technical report, DTIC Document, 2007.
- [19] Knight M. *Hardware engineering change management: an enterprise analysis of factors contributing to technical change*. PhD thesis, Massachusetts Institute of Technology, 2013.
- [20] Taleb N. The black swan: Why don't we learn that we don't learn. *NY: Random House*, 2005.

- [21] Aven T. and Renn O. The role of quantitative risk assessments for characterizing risk and uncertainty and delineating appropriate risk management options, with special emphasis on terrorism risk. *Risk Analysis*, 29(4):587–600, 2009.
- [22] Aven T. On the meaning of a black swan in a risk context. *Safety science*, 57:44–51, 2013.
- [23] Aven T. On the critique of beck’s view on risk and risk analysis. *Safety Science*, 50(4):1043–1048, 2012.
- [24] Aven T. and Krohn B. A new perspective on how to understand, assess and manage risk and the unforeseen. *Reliability Engineering & System Safety*, 121:1–10, 2014.
- [25] Bruce R., Dan M., and et al. *Safety, Reliability, Risk and Life-Cycle Performance of Structures and Infrastructures*. CRC Press, 2014.
- [26] Savransky D. *Engineering of creativity: Introduction to TRIZ methodology of inventive problem solving*. CRC Press, 2002.
- [27] Altshuller G., Shulyak R., and et al. *40 principles: TRIZ keys to innovation*, volume 1. Technical Innovation Center, Inc., 1998.
- [28] Altshuller G. *And suddenly the inventor appeared: TRIZ, the theory of inventive problem solving*. Technical Innovation Center, Inc., 1996.
- [29] Terninko J., Zlotin B., and et al. *Systematic innovation: an introduction to TRIZ (theory of inventive problem solving)*. CRC press, 1998.
- [30] Rantanen K. *Simplified TRIZ: New problem solving applications for engineers and manufacturing professionals*. CRC press, 2010.
- [31] Yamashina H. and Takaaki H. Innovative product development process by integrating qfd and triz. *International Journal of Production Research*, 40(5): 1031–1050, 2002.
- [32] Mann D. An introduction to triz: The theory of inventive problem solving. *Creativity and Innovation Management*, 10(2):123–125, 2001.
- [33] Orloff M. *Inventive thinking through TRIZ*. Springer, 2006.

- [34] Stratton R. Systematic innovation and the underlying principles behind triz and toc. *Journal of Materials Processing Technology*, 139(1):120–126, 2003.
- [35] Yang Z. H. A comparison of triz and axiomatic design. In *INTERNATIONAL CONFERENCE ON AXIOMATIC DESIGN*, volume 1, pages 235–242, 2000.
- [36] Royzen Z. Solving contradictions in development of new generation products using triz. *The TRIZ Journal*, 1997.
- [37] Matthew H., Kai Y., and et al. Enhancing robust design with the aid of triz and axiomatic design (part i). *TRIZ Journal*, October, 2000.
- [38] Barry K., Domb E., and et al. Triz-what is triz. *The Triz Journal. Real Innovation Network*. http://www.triz-journal.com/archives/what_is_triz/. Retrieved, 2, 2010.
- [39] Litvin S. New triz-based tool—function-oriented search (fos). *the TRIZ Journal*, August, 2005.
- [40] Domb E. Strategic triz and tactical triz: Using the technology evolution tools. *TRIZ-Journal*. [http://www.triz-journal.com/archives/2000/01\(2002-12-05\)](http://www.triz-journal.com/archives/2000/01(2002-12-05)), 1999.
- [41] Young J. The method for uncoupling design by contradiction matrix of triz, and case study. In *Proceedings of Third International Conference on Axiomatic Design, Seoul*, pages 21–24, 2004.
- [42] Domb E., Dettmer H., and et al. Breakthrough innovation in conflict resolution: Marrying triz and the thinking process. *TRIZ Journal*, 5:1–11, 1999.
- [43] Nakagawa T., Hideaki K., and et al. Reorganizing triz solution generation methods into simple five in usit’. In *ETRIA World Conference” TRIZ Future*, pages 6–8, 2002.
- [44] Gunther S. and Grawatsch M. Triz-based technology intelligence. In *16th International Conference on Management of Technology. Anais eletrônicos... Washington: IAMOT*, 2004.
- [45] Gunther S. and Grawatsch M. Triz-based technology intelligence. In *16th International Conference on Management of Technology. Anais eletrônicos... Washington: IAMOT*, 2004.

- [46] Runhua T. The conceptual design of a fast clasping mechanism based on function means tree and triz. *TRIZ Journal*, 2000.
- [47] Savransky S., Stephan C., and et al. Triz: The methodology of inventive problem solving. *The Industrial Physicist*, 2(4):22–25, 1996.
- [48] Nakagawa T. Approaches to application of triz in japan'. In *TRIZCON2000: The Second Annual AI TRIZ Conference, Apr*, pages 21–35, 2000.
- [49] Khomenko N. and Kucharavy D. Otsm-triz problem solving process: solutions and their classification. In *Proceedings of TRIZ Future Conference*, pages 6–8, 2002.
- [50] Nakagawa T. Essence of triz in 50 words. *TRIZ Journal*, <http://www.triz-journal.com>, 2001.
- [51] Hipple J. The integration of triz problem solving techniques with other problem solving and assessment tools. *Principal Innovation-TRIZ Tampa, FL33647USA*, 2003.
- [52] Lerner L. Genrich altshuller: father of triz. *Ognonek*, 1991.
- [53] Yeh C., Huang J., and et al. Integration of four-phase qfd and triz in product r&d: a notebook case study. *Research in Engineering Design*, 22(3):125–141, 2011.
- [54] Verbitsky M. Semantic triz. *Invention Machine Corporation, Boston*, 2004.
- [55] Shin G. and Park G. Decoupling process of a coupled design using the triz module. In *International Conference on Axiomatic Design, ICAD*, volume 6, pages 13–16, 2006.
- [56] Zlotin B. and Zusman A. The concept of resources in triz: past, present and future. *Ideation International, December 2004–March*, 2005.
- [57] Nakagawa T. Education and training of creative problem solving thinking with triz/usit. In *Proceedings of the TRIZ Future 7th World Conference, Frankfurt am Main*, pages 6–8, 2007.
- [58] Bultey A., De-Bertrand D., and et al. A substance-field ontology to support the triz thinking approach. *International Journal of Computer Applications in Technology*, 30(1):113–124, 2007.

- [59] Bridoux D. and Mann D. Evolving triz using triz and nlp. *paper to be presented at TRIZCON2002, St Louis, 2002.*
- [60] Wu T. The study of problem solving by triz and taguchi methodology in automobile muffler designation. In *Proceedings of the TRIZ Conference, Department of Industrial Management, Tung-Nan Institute of Technology, Taipei, 2004.*
- [61] Mann D. and Hey J. Triz as a global and local knowledge framework. *Concurrent Engineering: Advanced Design, Production and Management Systems*, pages 581–589, 2003.
- [62] Clarke D. Integrating triz with value engineering: Discovering alternatives to traditional brainstorming and the selection and use of ideas. In *SAVE INTERNATIONAL PROCEEDINGS*, pages 42–51, 1999.
- [63] Regazzoni D. and Russo D. Triz tools to enhance risk management. *Procedia Engineering*, 9:40–51, 2011.
- [64] Savransky S. *Engineering of creativity: Introduction to TRIZ methodology of inventive problem solving*. CRC Press, 2002.
- [65] Terninko J., Zlotin B., and et al. *Systematic innovation: an introduction to TRIZ (theory of inventive problem solving)*. CRC press, 1998.
- [66] Rantanen K. and Domb E. *Simplified TRIZ: New problem solving applications for engineers and manufacturing professionals*. CRC press, 2010.
- [67] Altshuller G., Shulyak L., and et al. *40 principles: TRIZ keys to innovation*, volume 1. Technical Innovation Center, Inc., 1998.
- [68] Souchkov V. Breakthrough thinking with triz for business and management: An overview. *ICG Training & Consulting*, 2007.
- [69] Yuan F., Wang T., and et al. Function and principle innovative design of mechanical products based on triz/fa. *Frontiers of Mechanical Engineering in China*, 1(3):350–355, 2006.
- [70] Wei Z., Tan R., and et al. Research on complex problem analysis in triz. In *Management of Innovation and Technology, 2008. ICMIT 2008. 4th IEEE International Conference on*, pages 755–760. IEEE, 2008.

- [71] Ball L. Hierarchical triz algorithms. *The TRIZ journal*, 2006:52006–2007, 2005.
- [72] Chulvi V. and Vidal R. Triz on design-oriented knowledge-based systems. *A study on function level. The TRIZ Journal. vMarch*, 2009.
- [73] Céline C., de Guio R., and et al. Facetwise study of modelling activities in the algorithm for inventive problem solving ariz and evolutionary algorithms. In *Design Computing and Cognition'10*, pages 189–207. Springer, 2011.
- [74] Souchkov V. Accelerate innovation with triz. *Available from:(accessed 30.11.11)*, 1997.
- [75] Spain E. Triz: uncovering hidden treasures. In *HKIVM International Conference*, 2003.
- [76] Livotov P. Approach to complete search of innovation concepts and customization of triz-tools. In *Proceedings of the ETRIA World Conference, Bath UK*, pages 7–9, 2001.
- [77] Soderlin P. Thoughts on ariz do we need to redesign the ariz 2000? *TRIZ Journal*, 2003.
- [78] Litvin S., Petrov V., and et al. Triz body of knowledge. *TRIZ developers summit, Russia. Accessed December, 18:2012*, 2007.
- [79] Raviv D. Do we teach them how to think? In *Proc. of the 2002 ASEE Annual Conf. and Exposition*, 2002.
- [80] Fey V. and Rivin E. Triz: A new approach to innovative engineering and problem solving. *Target, Association for Manufacturing Excellence*, 12(4): 7–13, 1996.
- [81] Yu K., Ming L., and et al. Integrated conceptual design with triz. *The TRIZ Journal*, 2008.
- [82] Subzwari K., Mokhov S., and et al. Triz: A theory of inventive problem solving. 2006.
- [83] Fei G., Gao J., and et al. A triz based methodology for the analysis of the coupling problems in complex engineering design. In *Proceedings of the 19th CIRP Design Conference–Competitive Design*. Cranfield University Press, 2009.