



University of
Stavanger

Faculty of Science and Technology

MASTER'S THESIS

Study program/Specialization:
Petroleum Technology,
Well Engineering

Spring semester, 2016

Open

Writer:
Kent Trodal Borsheim

.....
(Writer's signature)

Faculty supervisor:
Ole-Erik Vestøl Endrerud

Thesis title:
Cement Plugging of Highly Deviated Wells Displaced in Oil Based Mud

Credits (ECTS): 30

Key words:

Plug and abandonment
High deviation
Simulation software
Contamination
Cement plug

Pages: 140

Stavanger, 15/06/2016

Abstract

When an oil or gas well is not profitable to produce from anymore, it needs to be temporarily or permanent plugged and abandoned (P&A). These operations are required in order to leave a well secured with sufficient barriers to prevent leakage. With a lot of old wells finishing their useful lifetime and others not able to produce profitably, the need of P&A operations are increasing on the Norwegian continental shelf (NCS).

With increasing number of operations comes increasing number of challenges and problems. One of the most common difficulties in plugging a well in the NCS is when the well is highly deviated. Plugging in the highly deviated areas of the well gives great challenges to the plugging material, mud composure and the plugging technique.

This thesis evaluates the different parameters affecting a cement plug placement in a highly deviated well using oil based mud which creates yet another challenge in avoiding contamination of the cement used. The parameters were thorough investigated and fed into a simulator (“Cementics zonal isolation” from Schlumberger) in order to find out which role the different parameters had in cement plugging of a well in given conditions.

After numerous simulations focusing on the contamination risk at each individual case, it was concluded some results. A deviation angle towards horizontal can be beneficial for less contamination, rather than a deviation angle of 60° which proves to be more exposed to contamination risk. Stinger size and length affect the contamination, and the industry practice with the stinger length being 1.5 times the plug length was confirmed.

Different plugging methods were also simulated against each other, and in a highly deviated well, the two plug method seems to have the best results in terms of contamination and plug length. The effect of dogleg severity (DLS) was also investigated, and though differences were spotted, no conclusion could be made.

Acknowledgement

This thesis is made to fulfill the requirements to achieve the degree Master of Science in Petroleum Technology at the University of Stavanger. The thesis has been written mostly at UiS, and experimental work has been done in a Schlumberger software “Cementics zonal isolation” on a loan computer by same company.

I would like to thank my supervisor, Ole-Erik Vestøl Endrerud for guidance throughout the thesis. His knowledge in how approach the thesis, structure the work and guidance to achieve the best possible outcome have been of great help. His positive constructive feedback helped my motivation when things were tough, and I owe him a big thank you.

I would like to express my gratitude to Schlumberger as a company for letting me use their software on a loan computer, and to HR employee Bernt Nilsen for helping me obtain access to the software. I would also like to thank Schlumberger employee Nacera Bourada for all her help teaching me Cementics software, and for guidance through simulation process. Her expertise and patience in my questions and wonderings has been very useful.

Also a big thanks to Mahmoud Khalifeh for teaching the course in P&A autumn of 2015 that taught me the basis for my thesis, and thanks for guiding help in the beginning of thesis. To Prof. Mesfin Belayneh Agonafir for always be available for questions and wonderings, and for helping me obtain formation data. Both contributes has been very much appreciated throughout these months.

A special thanks to my uncle Norolf Henriksen who helped me find a suitable task for my thesis, and get me in touch with the right people at Schlumberger.

Big thanks also to my family who has supported me throughout all of my study, and for always believing in me. And a final thanks to all my classmates and friends who has supported me and worked alongside me throughout the study.

Contents

Abstract	II
Acknowledgement	III
Contents.....	IV
List of Tables.....	VI
List of Equations.....	VII
List of Figures	VIII
Abbreviations.....	IX
1 Introduction	1
1.1 Background	1
1.2 Objectives	2
1.3 Literature review	3
1.4 Problems With Cement Plug in Deviated Wells	5
2 General Plug and Abandonment	9
2.1 Plug and Abandonment phases	10
2.2 Regulations (NORSOK).....	13
2.3 Plug verification.....	19
2.4 Equipment/Vessels used.....	21
2.5 Plug setting methods	25
2.6 Material (Cement)	29
3 Methodology and Preparation	31
3.1 Data gathering	33
3.2 Software data input.....	36
3.3 Fluid design.....	38
3.4 Placement design	41
3.5 Simulation part	44
3.6 Calculations used in software.....	47
4 Results and Discussion	49
4.1 Dogleg severity effect on the cement plugging.....	49
4.2 Angle of entering of reservoir effect on plugging	53
4.3 Stinger size evaluation	56

4.4 Stinger length evaluation	58
4.5 Balanced plug vs. two plug method	62
5 Conclusion and Further Work.....	63
6 References	65
Appendix A	67
Appendix B.....	83
Appendix C	125

List of Tables

Table 1: NORSOK Length regulations [7]	17
Table 2: P&A Code table. X for required rig	21
Table 3: Heidrun field	34
Table 4: Norne field data.....	34
Table 5: Field X data.....	35
Table 6: Plug design data: Surface data	36
Table 7: Tubular and Hole design	36
Table 8: Formation and temperature design.....	37
Table 9: Simulation process	45
Table 10: DLS effect on contamination with normal sized stinger.....	50
Table 11: DLS effect on contamination with small sized stinger	51
Table 12: Inclination effect on contamination with normal sized stinger.....	53
Table 13: Inclination effect on contamination with small sized stinger.....	54
Table 14: Stinger size evaluation considering contamination.....	56
Table 15: Stinger length differences effect on plug length with normal sized stinger.....	59
Table 16: Stinger length differences effect on plug length with small sized stinger	60
Table 17: Best plugging method in terms of plug length results	62
Table A.1 - 5: Plug operation summary.....	68
Table A.6 - 9: Well data summary.....	69
Table A.10 - 11: Fluids summary.....	71
Table A.12 - 13: Mud circulation.....	73
Table A.14 - 15: Fluid placement.....	74
Table A.16: Static POOH.....	75
Table A.17 - 18: Pumping schedule.....	76
Table A.19: Well security.....	77
Table A.20: Final contamination risk.....	81
Table A.21 - 23: Operator summary.....	82
Table B.1 - 40: POOH results case 1-120.....	84
Table C.1 - 5: POOH results case 1-10.....	126

List of Equations

Eq.1: Calculating hydrostatic pressure.....	15
Eq.2: Calculating setting depth.....	15
Eq.3: Calculating average velocity in inclined pipe.....	54

List of Figures

Figure 1: Water channeling high side, Mud channeling low side	6
Figure 2: Slumping of cement [9]	8
Figure 3: Example of primary and secondary barrier [7]	11
Figure 4: Calculation of plug setting depth	16
Figure 5: Example of barriers open hole [7]	18
Figure 6: Influx test failure and success	20
Figure 7: Island Constructor, a rig-less vessel[12].....	22
Figure 8: Example of cement wiper plugs.[14].....	24
Figure 9: Balanced cement plug [9]	26
Figure 10: Two plug method [9]	27
Figure 11: Dump bailer method [9].....	28
Figure 12: Heidrun and Norne field placement [18]	33
Figure 13: Oil based mud design and rheology[20]	39
Figure 14: Spacer design and rheology [20]	39
Figure 15: Slurry design and rheology [20]	40
Figure 16: Example of mud circulation results from software.....	42
Figure 17: KOP and DLS visualized.....	44
Figure 18: Minimum Curvature Method (from software).....	47
Figure A.1-5: Well data summary.....	69
Figure A.6: Fluid summary.....	72
Figure A.7-8: Mud circulation.....	73
Figure A.9: Fluid placement.....	74
Figure A.10: Static POOH.....	75
Figure A.11-13: Pumping schedule.....	76
Figure A.14: Well security.....	77
Figure A.15-17: Temperature outputs.....	78
Figure A.18-20: Wellclean 3.....	79
Figure A.21: Final Contamination risk.....	81
Figure B.1-40: POOH results case 1-120.....	84
Figure C.1-5: POOH results case 1-10.....	126

Abbreviations

Atm	-	Atmospheric pressure
CO ₂	-	Carbon dioxide
DL	-	Dogleg
DLS	-	Dogleg severity
g	-	Gravity, 9.81 m/s ²
H _{cloumn}	-	Height column
H ₂ S	-	Hydrogen sulfide
HSE	-	Health Safety Environment
ID	-	Inner diameter
KOP	-	Kick off point
MD	-	Measured depth
NCS	-	Norwegian Continental Shelf
NORSOK	-	“Norsk sokkel konkurranseposisjon”
NORSOK	-	“Norwegian offshore sector competitiveness”
NPD	-	Norwegian petroleum directorate
OBM	-	Oil based mud
OD	-	Outer diameter
P&A	-	Plug and abandonment
PSA	-	Petroleum safety authorities
Pres	-	Reservoir pressure
POOH	-	Pull out of hole
SG	-	Specific gravity
TOC	-	Top of cement
TVD	-	True vertical depth

1 Introduction

1.1 Background

Since 1969 when oil was first discovered on the NCS, oil and gas has been produced in large numbers. But with increasing numbers in old and no longer profitable wells, plug and abandonment (P&A) has also become an important part of the operations being done offshore of Norway. P&A is the last part of a well's life cycle, and consist in sealing the well temporarily or permanent. The purpose of sealing the well is to avoid leakage of oil and gas to the environment, and/or to offload platforms/rigs to be used elsewhere. The P&A of a well consist in creating barriers often out of cement plugs to stop potential influx of reaching other permeable zones or the surface.

Caused by strict regulations, P&A has become very time consuming and costly. It has therefore become a very important part of the oil and gas industry. A lot is being done to make P&A more efficient and less costly without going on compromise with safety and regulations. With wells being drilled more advanced than before, P&A jobs has become more advanced and with bigger possibilities of failures. With well trajectory going from vertical to horizontal and also possible multilateral, wells have created challenges for the P&A operations.

Especially in the NCS the regulations has become stricter resulting from increasing focus on HSE (health, safety and environment). After accidents, near accidents and other incidents reported, authorities and regulators have seen it necessary to revise rules and standards. Companies not following standards and regulations can be sanctioned. It is therefore important both economically and HSE wise that plugging abandonment is done without problems occurring. Especially in highly deviated wells filled with oil based mud (OBM) problems has occurred in terms of contaminated slurry during cementing of plugs.

1.2 Objectives

This master thesis will investigate different problems occurring when cement plugging an open hole completion in a highly deviated well displaced in OBM. Plugging of deviated well has been a bigger challenge in some wells than expected [1, 2]. The thesis will investigate what factors influencing the cement plugging and the difference between theoretical outcome and simulated outcome. The thesis will discuss the use of different techniques, different well trajectory, and different equipment used in plugging of a deviated well. The results from software simulation of different scenarios and cases will be discussed around and concluded.

The goal of the thesis is to establish how different plugging techniques, well trajectory and equipment can affect the contamination results at different scenarios. The thesis will use simulation software to build up the correct test basis, and to easily be able to adjust parameters in order to test the different scenarios. From results and outcome of the simulations, further research and work will be recommended for others to perform.

1.3 Literature review

To choose a thesis that is challenging, interesting, and topical for the industry today is difficult. The inspiration to choosing a thesis was to do work around something that the oil industry has problems with today. To do so it was necessary to reach out to the industry in person to find the challenges they are facing. By talking to the drilling and wells superintendent in the oil company Wintershall, interesting topics were discovered. The superintendent requested information from the engineers in the company on challenges in operations. One of the challenges that were proposed was the difficulty to cement plug a highly deviated well displaced in OBM in an open hole completion. Studying to become a drilling engineer, courses in P&A is mandatory, and with that knowledge in basis, the task proposed was interesting and challenging to take on.

There were many ways to approach the task, with looking at different aspects of the plugging. It could have been to look at the cement composition, and do lab experiments to improve the plug material. Another approach was to choose simulation software to investigate different aspects affecting the plug results, which ended up being the preferred approach in this thesis.

It was a challenge to search for similar reports, thesis or documentation that took on the specific problem, but some useful reports were found containing challenges in cementing casings in highly deviated well trajectories. Reports and documentation including contamination danger in cementing operation were also read, and especially reports including cases where OBM were used.

To get the right amount of basic knowledge of P&A and cementing process of a plug setting, reading a lot of different background material was necessary. Old lecture notes and material from the P&A course was very useful. As were reading most of the Well Cementing book[3] from Schlumberger along with different publications online containing P&A and cementing.

About the specific problem there is a good paper written of a case study in the Caspian Sea[1] where modified approach led to successful cementing in highly deviated wells. In this real case there was a problem in achieving a fully sealing plug that could qualify as a barrier. Unstable fluid interfaces caused by gravitational separation led to fluid contamination, and an incomplete sealing of the well. By use of advanced simulation software, adjustments were

made to change of equipment (stinger type) and use of high viscous reactive and pills to reduce the contamination.

Other problems were investigated in papers like the ones from Crook and Keller et.al [4, 5] handling cementing of casing in highly deviated wells. The papers review problems with channeling both high side (water), and low side (mud). The channeling occurred because of separation of fluids caused by gravity, and they troubled in setting good cement. The solution to this problem was to use better washing techniques to better displace the mud, and to use higher yield point in mud to avoid channeling from occurring. Proper slurry design also proved to be important to avoid water from escaping out of the slurry and creating water channels through the cement.

1.4 Problems With Cement Plug in Deviated Wells

As described, there are several recorded problem areas with cement plugging in a deviated well. In this thesis, the most common problems are analyzed and simulated for in an open hole completion. The information gathered is also problems experienced with cementing casing in deviated wells, cement-contamination in general, and specific examples of cement plugging in open hole.

General failure of cement plugs are as described in Cementing Technology by Dowell Schlumberger: [6] “lack of hardness, poor isolation, wrong depth, sinking. And with reason for failure to be: Poor slurry design, not correct WOC time, Inaccurate BHST, contamination during displacement and pull out of hole (POOH), wrong volume cement, and too high density differences between mud and cement.”

One of the challenges with cementing a highly deviated well is the gravity, when displacing the mud to cement. In the article by S.R.Keller et.al [5] a deviated wellbore casing is cemented and is experiencing problems associated with the displacement. Because of gravity the mud on the low side of the casing is more difficult to replace than the mud on the high side. On the low side of the casing there is a big chance of mud-channeling through the cement. Mud-channeling through the cement plug is a critical failure and would lead the casing cement, or cement plug to not have full integrity. Either the channeling is through the cement or more common along the rock wall, the cement plug will not be able to fulfill the requirements. Requirements from regulations[7] states that the plug need to be 100% cross-sectional (either from rock to casing, or all across in open hole), with good bonding to formation.

The explanation is simple on why the channeling occurs. When mud settles in a highly deviated well, the particles from the added weighting material will sag down in the well on the low side. These particles are not as easily displaced because of difficulties in washing of a high angle well. The mud particles can mix in with the cement, causing mud-channeling through the plug making it incomplete as displayed in **Fig.1** [5].

In a different way the gravity works also against the cementing process by separating free water from the cement slurry. Because of the water density is lower than the slurry, it could be

able to break out of the cement before it settles and create water-channeling. The water-channeling is similar to the mud-channeling leading to incomplete sealing, only this time on the high-side of the well[5].

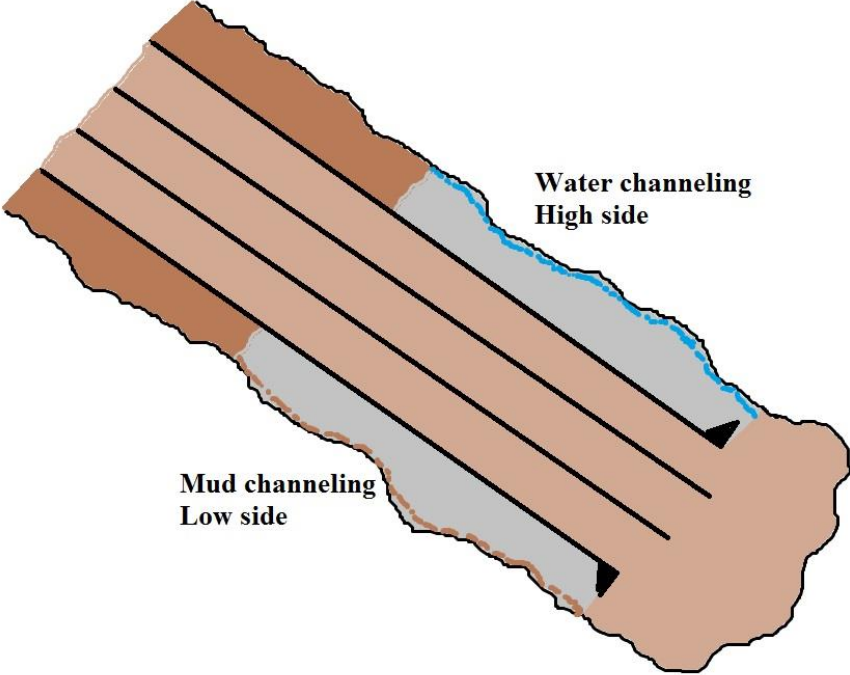

Figure 1: Water channeling high side, Mud channeling low side

Both these problems occurred more often when the angle of deviation was greater, which proves that mud-channeling and water-channeling could be a possible problem when cementing a highly deviated well. Although this was done by cementing a casing in annulus, some of the principles also applies to cementing a plug, and is something to consider when cement plugging in high inclinations.

From the paper describing these problems and solutions [4, 5], it is done experimental work in how to avoid channeling when cementing in high deviation angle. The conclusion from these papers was that the mud-design needs to be accurate with correct yield point (stress needed to break the gel when the mud has settled). With higher deviation angle on the well, the larger yield point is needed to avoid mud-settling. A part of the solution was also to use plenty of washers and cleaners. This use proved to be efficient in avoiding mud remains creating channeling.

Another big problem not only when plugging, but in all cement operations is contamination. OBM is often used in well operations because of its good properties. OBM lead to higher drilling rates, less chance of sticking, and most important that it will not react chemically to shale formation as water based mud do. Shale can be very reactive to water and swell to be many times their original size, leading to unstable formation or blockage of annulus around drill string. Inhibitors may be added to water based mud to prevent shale swelling, and additives can resemble OBM properties. But overall the OBM is preferred during drilling/completion phase because of its good properties and rheology. The downside with OBM when cementing is that there is a much higher chance of contaminating the cement during the process[8].

Contamination of cement is when drilling/completion mud mixes with the cement slurry during the cement process. The mixing can occur when fluid interfaces meet, or by old particles that has not been displaced. Contaminated cement will not set as expected, and will not have anywhere near the quality and sealing needed to be regarded as a permanent plug. It is very normal that parts of the cement get contaminated. Both top and bottom of cement column is often partly contaminated as these parts are exposed to the mud. By checking for top of cement (TOC) as verification method, it can be determined whether or not the cement is contaminated or not. With contaminated cement, the top part of the cement column will be soft and therefore easily tagged through. The measured tagged TOC will then be at lower depth than pre calculated, which will indicate contamination. A contaminated cement would lead to a poor plug that is not following the length requirements of NORSOK D-010[7], and therefore cannot qualify as a permanent barrier.

Contamination of cement can happen regardless of how good the washing process is of the well is, and regardless of how good spacer and displacement techniques that is used. But taking the contamination risk into account can reduce it, and by compensating for losing cement to contamination can give good plugging results regardless. This is why simulation of cement process is very important regarding contamination. If there is a big possibility for contamination, then additional cement needs to be pumped. Additional cement slurry will increase the plug length, and reduce the poor cement/good cement ratio.

When reducing contamination, the interface between layers becomes more distinct. Regardless it is nearly impossible to get a complete cross-sectional layer at top and bottom of

cement inside hole because of gravity. This happens of natural reasons only when the well is deviated, and becomes more clear when the angle in well is very high towards horizontal. This is not really a problem, but an effect to be taken account for and called slumping[9]. When cementing highly deviated wells, slump length (**Fig.2**) needs to be accounted for, both in front and back of the cement slurry.

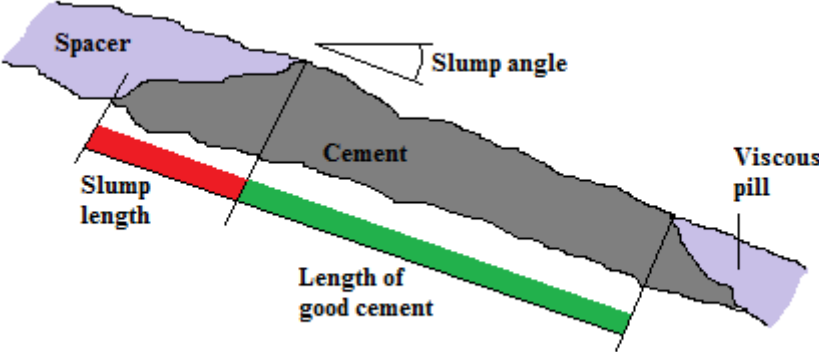

Figure 2: Slumping of cement [9]

2 General Plug and Abandonment

When a well's useful lifetime is over, or in other words not producing enough hydrocarbons to make it profitable, it needs to be closed down. This could be either a temporarily plugging or a permanent plugging. A temporary plugging is done to wait for better technology, higher oil-price, or other factors needing temporary closing of the well. In time, the well could either increase the income, or decrease the cost of production to make the well profitable to produce from again. The plugging could also be permanent if the company does not see any future need of the well. Either way the well needs to be secured by barriers that acts like sealing, to prevent leakage between permeable zones, or to surface. This is to preserve the environment both locally around the well, but also to prevent for example oil spill that tend to drift out far in the ocean, and seriously harming animal life or environment. If the plugging is done temporarily, the well should also be accessible without danger if it would to be reopened, which means that the barriers set would need to be either drillable or retrievable.

A P&A operation is usually divided into 3 distinct phases as described in the SPE paper by Fatemeh et.al which the next subchapter 2.1 of this thesis is based on [10]. Although P&A is done differently between wells, each operation usually follows these phases. In the first phase the main goal is to seal and plug the reservoir/injection zone where the reservoir fluids are preserved. The second phase is to seal/plug other zones with potential for flow to surface, either its hydrocarbons or water bearing zones. The last phase is retrieving the wellhead and casing strings to surface according to regulations set by the NORSOK standard, and to remove all excess equipment away from the environment.

2.1 Plug and Abandonment phases

This subchapter is based on the paper by Fatemeh et.al about cost estimation[10].

Phase 1 – Sealing of the reservoir zone

The first thing in a P&A operation is stopping the flow of hydrocarbons, which is called killing the well. This could be done in numerous ways, but the essence in all methods is to displace the fluids in the well with higher density fluid. This increases the pressure in the well to be higher than the reservoir pressure, and prevents the lighter oil/gas to enter the wellbore. This is because of basic physics which tells us that fluids will flow from high to low pressure, and thus with higher pressure in the wellbore, the influx of hydrocarbons will not come from reservoir.

After killing the reservoir, the preparation of plugging of the well can start. First after the well is secured with temporary barriers, the Xmas tree is removed and the Blow out preventer is installed, before tubing and lower completion is pulled. It could be possible to plug the well while the tubing is still in hole, but if there is control-lines or other objects that could interfere with the sealing; the tubing has to be removed.

Then it's time to seal and secure the reservoir by creating barriers, often done by cementing plugs. The plugs seal across the entire cross-section of the well just above the potential of leakage from reservoir. If there is casing where the plug is set, it is necessary to validate the cement behind casing by logging before setting the inner plug. In case of multiple reservoir zones, all has to be sealed off according to the regulations. The zones should also be sealed from each other to prevent cross-flow between reservoirs. All hydrocarbon bearing zones needs to be isolated with two barriers as shown on **Fig.3**. A primary barrier to prevent fluids from flowing in well, and a secondary barrier if the primary should fail.

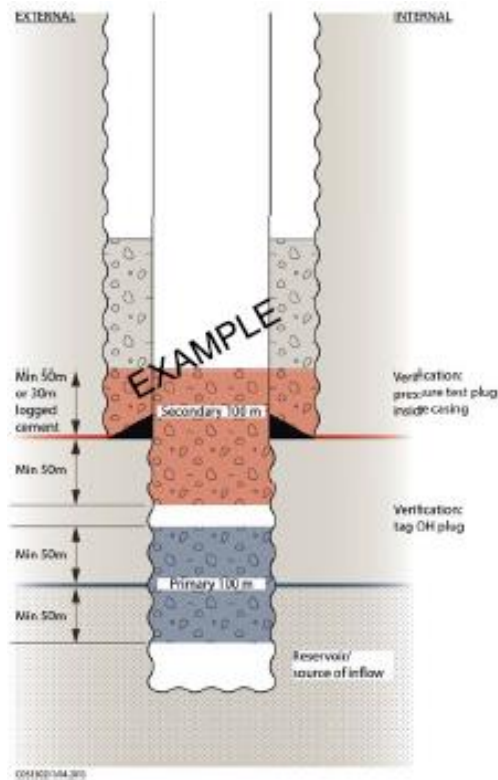

Figure 3: Example of primary and secondary barrier [7]

Phase 2 – Sealing of intermediate zones potentials

After the reservoir section is secured it is necessary to also secure all other potential zones of inflow into well. There could be from zero to many of these zones in a well, and depends on what is drilled through in terms of shallow gas, water zones, and other permeable formation. All these different zones should also be sealed off according to regulations in NORSOK[7]. After securing the intermediate zones, a surface plug needs to be set just below seabed. The surface plug purpose is both to act as a third barrier of leakage from the well, and to act as a shield for items, etc. to fall into the well. The surface plug is also often called environmental plug, which describes more the purpose of the last line of defense. The plug seals the environment from interfering with the well, and the well from interfering with the environment. Though will the surface plug not provide pressure protection should the barriers down hole fail.

Phase 3 – Pulling of wellhead and casing strings

When the environmental plug is set, the P&A operation is in its last phase, which is kind of a “clean up” part of the operations. The objective within this phase is to remove all equipment and parts of the well which is above the seabed. After some time after production it is common many places that the sea bottom will be depleted some, resulting from removal of hydrocarbons underground. Because of this potential depletion, the casing strings has to be cut some meters below seabed to prevent that the well from coming above the seabed at a later stage. After removing wellhead, casing strings and all excessive equipment on seabed, the P&A operation is completed. It depends where the well is located in the world, but on the NCS it is common that the field should be trawl able for fisher boats, and that all unnatural equipment should be removed.

2.2 Regulations (NORSOK)

When setting a cement plug in the NCS it has to be done accordingly to the NORSOK regulations [7] which this subchapter is based on. The abbreviation NORSOK is Norwegian and can be translated directly to “Norwegian offshore sector competitiveness”. The NORSOK standards are developed to ensure safety first of all, but also contribute to companies in how to do an efficient and correct job. Without these standards companies could make wrong judgments and base their choices for money purpose only, which will at some point affect the safety negatively both for the environment and human life.

By adding the NORSOK standards, the Norwegian petroleum industry set up a common set of “game rules” to follow. The Petroleum Safety Authorities (PSA) uses these standards to regulate and manage the activities on the NCS, and can give sanctions if these regulations are not met by the companies.

There are several NORSOK standards, but P&A of a well is regulated in the D-010 standard. The D-010 handles “well integrity in drilling and well operations”, and chapter 9 handles abandonment activities [7]. When P&A is performed on a well, these regulations are important to follow, and the standard describes properties required by plug, placement, length and integrity of plug, and also how to verify the plug.

Both for permanent plugging and temporary plugging the same regulations applies in terms of barrier properties and placement. The only difference is that it should be a possibility to re-open the well safely on a temporary plugging, which means that the plugs either should be retrievable or drillable in a temporary situation. There are some cases where special rules apply, and that is when a well needs to be suspended. For example when intervention is needed the well can be suspended for a short period of time. Then it could be accepted to use the fluid column as a barrier, which is not accepted in the other above mentioned cases.

A temporary plugging could be performed if it is possible that the well should be reopened at some later time. A temporary plugging can be done because of the profitability of the well, lack of technology or lack of knowledge to continue production from the given well. No matter what the reason for a temporary abandonment is, the risk of leakage should always be assessed when abandoning a well. Based on the assessment, it should be decided by the PSA

if the well should be a well with or without monitoring. With monitoring the well can be plugged temporary for as long as needed, but requires continuously monitoring and routinely testing. Without monitoring, the well can only be plugged for a maximum of 3 years, and a program for frequently visual (look for bubbles) observation should be established.

A permanent well barrier (a cement plug for example) should according to NORSOK D-010 [7] have the following characteristics:

- a) Provide long term integrity (eternal perspective);
- b) Impermeable;
- c) Non-shrinking;
- d) Able to withstand mechanical loads/impact;
- e) Resistant to chemicals/ substances (H₂S, CO₂ and hydrocarbons);
- f) Ensure bonding to steel;
- g) Not harmful to the steel tubular integrity.

There are also length, placement and number of barriers regulations described by NORSOK. In a well it is required two barriers for each permeable zone that either has the possibility of flow to surface, or zones containing hydrocarbons. If a permeable zone contains water with no potential of flow to surface, the zone can be isolated with only one barrier. This means when isolating two reservoirs in a well, the first reservoir (from top) has to be isolated with a set of barriers (primary and secondary). The bottom reservoir also has to be isolated with a set of barriers, but it can use the first reservoirs primary barrier as its secondary barrier. It is though required to have a cross-flow barrier between the reservoirs to ensure no flow between them, so at least one barrier should separate the zones. This way this example well would have three barriers, with one of them working as a common barrier for both reservoirs.

The placement of the barriers is very strict and crucial to ensure well integrity. If a buildup in pressure takes place from the reservoir below the primary barrier, the formation (if it is an open hole section) or the casing should be able to withstand the pressure. This is necessary to prevent leakage of hydrocarbons. To make sure that the buildup pressure in a well in a worst case scenario does not exceed the formation or casing limits, it is important to set the barrier at the right depth.

If it is an open hole section that is being sealed off, the fracture gradient of a formation (from logging) can tell how much pressure the formation can handle at each given depth without fracturing. In the case of a cased hole, the burst pressure rating of the casing can also determine the setting depth of the barrier.

If the primary barrier breaks and hydrocarbons (or water) flows through, the secondary barrier needs to be able to withstand the same pressure buildup as the primary barrier, which means that the setting depth of the barriers needs to be designed for the secondary barrier. There are a couple of ways to find the setting depth of the barrier, both graphically and by calculations.

Graphically the setting depth can be found by use of the pore and fracture plot of the well. The minimum setting depth of the barrier needs to be set at a height where the formation can withstand the pressures from hydrocarbons in the well without fracturing. By knowing the pore pressure at the reservoir depth, this is also the shut-in pressure (pressure below cement plug) that can be expected. When plugging the well this pressure could build up from below minus the pressure from the hydrostatic column of the reservoir fluid up to the plug height. The pressure found at per example at shut in at 2000m if the reservoir is at 2400m would be the pressure at reservoir (P_{res}) minus the hydrostatic pressure from reservoir fluid column of 400 meters.

$$\text{Hydrostatic pressure} = \rho_{fluid} * g * H_{column} \quad (\text{Eq.1})$$

$$P_{frac} \geq P_{res} - (\rho_{fluid} * g * H_{column}) \quad (\text{Eq.2})$$

This pressure needs to be equal or less than the fracture pressure at the given depth to qualify for a good setting depth. If the reservoir pressure is per example 250 bars ($250 * 10^5 \text{Pa}$), the shut in pressure at 2000 meters with reservoir fluid at 450kg/m^3 can be found to be from Eq.1: $250 * 10^5 - [450 * 9.81 * (2400 - 2000)] = 232.342 * 10^5 \text{Pa} = 232.342 \text{ Bar}$.

This setting depth can easily be found graphically by use of the pressure gradient of the reservoir fluid. This gradient creates a declining line in a pressure/depth plot, where it is possible to follow the line from reservoir pore pressure to crossing of the fracture pressure (hence **Fig.4**). Where the two lines meet will be the minimum setting depth of the secondary

well barrier. The primary barrier needs to be set below the secondary to ensure that both barrier plugs fulfill the requirements of integrity.

The pressure gradient of the fluid is always based on “worst case scenario”, which means that if there is gas in the reservoir, the gas density will be the base for the calculations as the shut in pressure will end up higher (worst case) with lower density fluid in the hydrostatic column below cement.

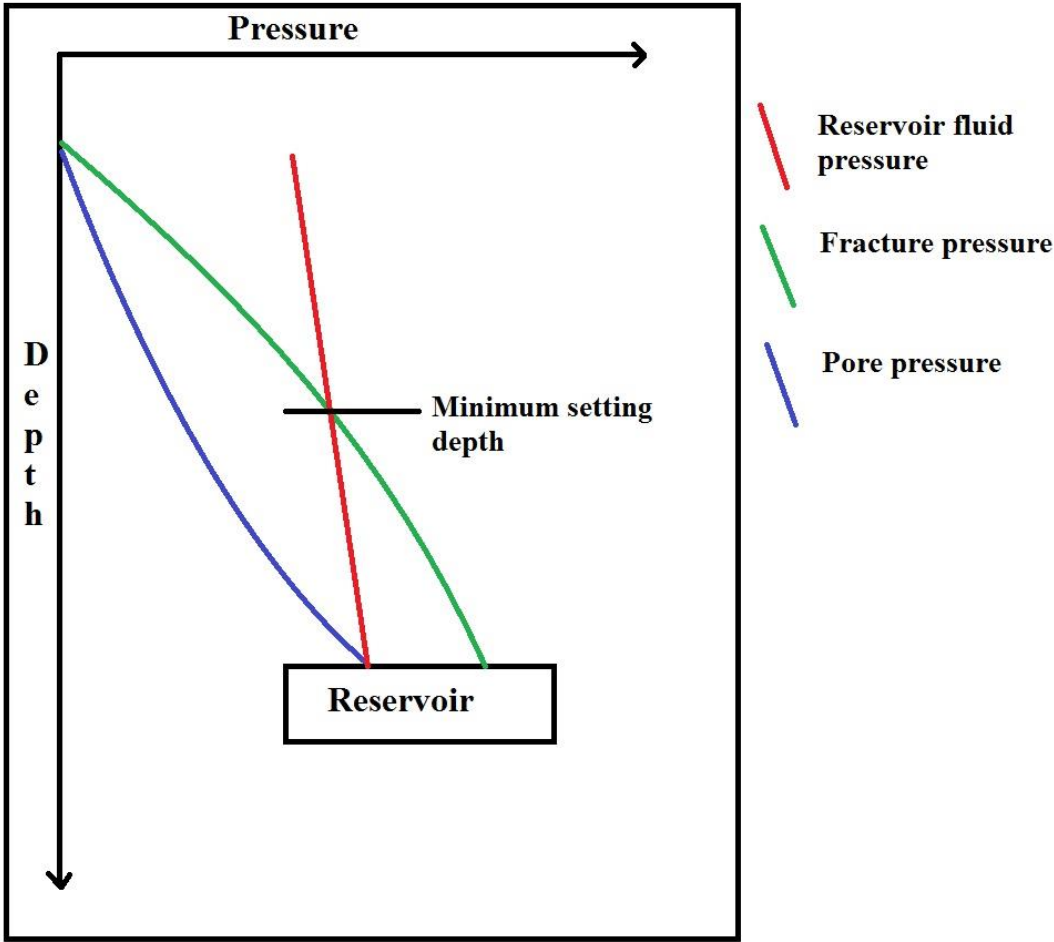

Figure 4: Calculation of plug setting depth

When the minimum depth of placement is calculated, it is also required that the barriers are set in an impermeable formation. Impermeable formation like shale prevents flow to be able to flow around the barriers through the formation. The purpose of setting the well barriers is to re-create the impermeable formation which prevented the oil from migrating in the first place, before it was drilled through. When creating a barrier just above the reservoir it is practically re-establishing of the cap rock. It is therefore important to have adequate length of

cement used in plugging to make sure the barrier keeps its integrity. Described in NORSOK [7] the required length of barriers are as **Table 1** displays:

Table 1: NORSOK Length regulations [7]

Open hole cement plugs	Cased hole cement Plugs	Open hole to surface plug
100 m measured depth (MD) with minimum 50 m MD above any source of inflow/leakage point. A plug in transition from open hole to casing should extend at least 50 m MD above and below casing shoe.	50 m MD if set on a mechanical/ cement plug as foundation, otherwise 100 m MD	50 m MD if set on a mechanical plug, otherwise 100 m MD.

In this thesis, the open hole cement plug will be like the one in **Fig.5**, and will be according to the length requirements from the regulations in the above Table 1.

When plugging a well, there is also a need of an environmental plug in the top of the well (open hole to surface plug) as earlier mentioned. This is a tertiary plug, but cannot be used as a primary or secondary barrier to withstand pressure. This is basically a plug to more or less prevent items falling into the well as displayed in Fig.5.

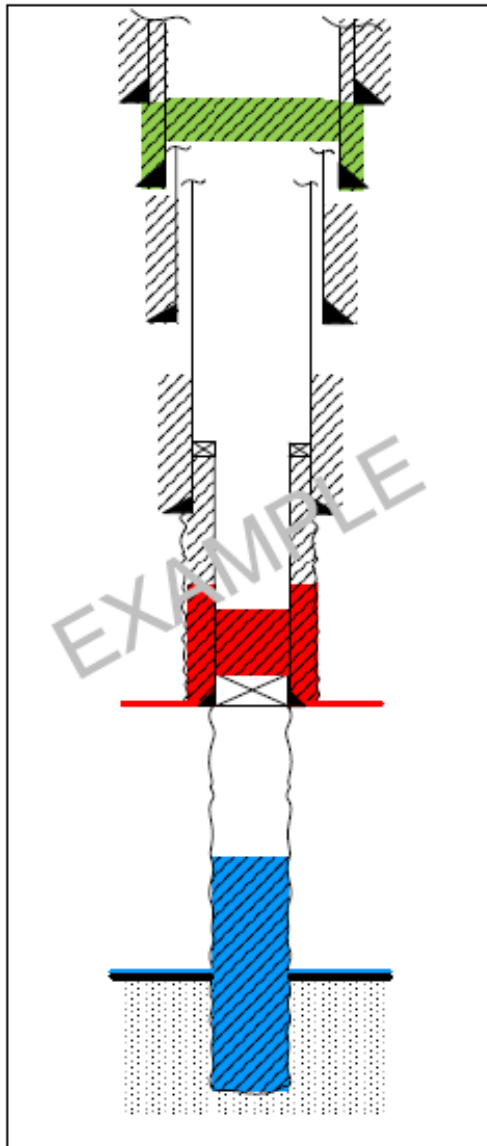

Well barrier elements	EAC table	Verification/monitoring
Primary well barrier		
In-situ formation	51	
Cement plug	24	
Secondary well barrier		
Formation in-situ	51	
Casing cement	22	
Casing	2	
Cement plug	24	
Open hole to surface well barrier		
Casing cement	22	
Casing	2	
Cement plug	24	

Figure 5: Example of barriers open hole [7]

2.3 Plug verification

When a plug is cemented in place, it needs to be verified. The plug needs to follow the NORSOK regulations, both with quality, integrity and placement. The easiest thing to verify is the placement of the plug. After calculations the plug is set at a minimum depth (see earlier calculations) to be able to withstand pressure, and to ensure setting it with impermeable formation around. But when setting a cement plug in a vertical or deviated well, there is always a possibility for the plug to either sink by gravity, or that cement is lost to either formation or mixed with drilling fluid. Then the length of the barrier will be insufficient, which will show when measuring TOC. This is a way of measuring whether the theoretical cement plug setting correlates with the real measured result.

When a plug is going to be cemented in place, the volume cement is simply calculated by the volume it needs to fill, and added safety margin if some should get lost or contaminated. This way the TOC should be easily established theoretically, and then tested to check if cement job was a success. The way to verify TOC is to go down with a drill string to some level above the calculated TOC depth. Then circulate and drill slowly with some pressure on bit through the soft cement, until sufficient resistance is measured when reaching the set cement top. If the TOC correlates with the theoretical depth, it is a good possibility that the cement job is a success, but other tests could need to be run to approve the cement job according to regulations.

To further test if the plug is impermeable and able to withstand pressure, it is common to do both an inflow test (**Fig.6**), and a pressure test. An inflow test is done to test if the plug seals perfectly, and to make sure that no channeling or voids has been created during the cement process. To test the plug for sealing capability the pressure differential across the cement in well is maximized, meaning that the well pressure above plug is reduced to minimum. When pressure differential is at its highest the well pressure is monitored, and if there is no change in pressure recorded, it can be concluded that the sealing is complete. Should there be a leaking in the plug, it would increase the well pressure above plug which can easily be picked up by measurements.

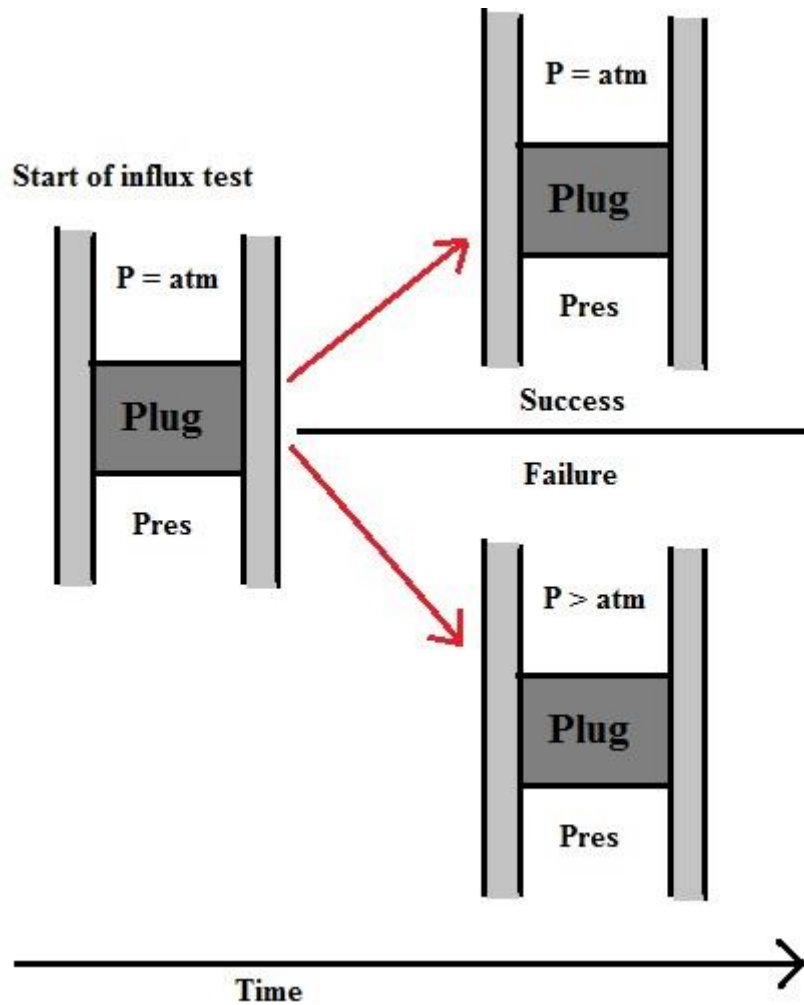

Figure 6: Influx test failure and success

When the sealing capability is confirmed, it is also important to pressure test the cement plug to be make sure it can stand a pressure increase in time. It is important to remember that the plug is set according to Norsok [7] “For eternal perspective”, which means that a pressure increase in time needs to be taken account for. Because the plug is somehow uniform, pressure can be added from top of plug to represent the possible pressure from below. By Norsok regulations the pressure in the test should be 1000psi above estimated leak of pressure below potential leak path. It should not at any circumstances exceed the casing burst pressure (also when the rating is corrected for de-rating from corrosion and so on).

When verifying an open hole cement plug tagging is the only verification required according to Norsok[7]. It could also be common to perform pressure test to some extent (up to 70 bars) above leak of test pressure for the formation with potential below the cement plug.

2.4 Equipment/Vessels used

When a P&A operation is being prepared it is common to give the operation a P&A code, worked out from Oil and Gas UK [11]. This is a 3 digit code which explains the complexity of each of the distinct abandonment phases. The P&A code gives an idea of which rig/vessel type each phase will require. A P&A code starts with explaining where the wellhead is set, either on platform (PL), at land (LA), or at subsea (SS). The letters is then followed by 3 numbers ranging from 0-4 in complexity (**Table 2**). Zero means that no work has to be done, 1 and 2 can be done by rig-less vessel, where the difference is the complexity of work that has to be done. The number 2 could require larger vessel with heavier equipment than number 1. As for complexity 3 and 4, the operation needs to be done by a rig. A light rig can perform the easiest operations (3), and a heavy rig with strong equipment can perform the most complex operations (4).

Table 2: P&A Code table. X for required rig.

Complexity	Simple rig-less vessel	Complex rig-less vessel	Simple rig	Complex rig
0	No work	No work	No work	No work
1	X	Optional	Optional	Optional
2	-	X	Optional	Optional
3	-	-	X	Optional
4	-	-	-	X

An example of a P&A code is PL 332 which will give a signal about that a simple rig is needed to perform the two first phases. Then the rig can be released for other work, while a complex rig-less vessel like the Island Constructor in **Fig.7** can perform the last P&A phase.

As every operation in the oil industry, P&A operations are also required to be cost-efficient. Therefore a complexity code is very helpful in deciding which rig/vessel to use in different phases, and if it is best to stick with one type of rig/vessel throughout the whole operation. A more complex vessel is more costly than a simple vessel, and if a rig is needed the expenses is far higher. Therefore it is important to use the P&A code and evaluate the options available.



Figure 7: Island Constructor, a rig-less vessel[12]

As for equipment used in a P&A operation there are different types to be used for different operations, and some of the equipment is limited by weight of lifting. For rig-less vessels, wireline is the most common equipment to use in P&A operations for lifting or use of tools. Wireline is a simple steel cable with tools attached at bottom to perform different operations. The wireline cable can be a slickline (simple line), or a braided line which is more robust and can hold more weight. The braided line also contains an electric cable which allows the operator to gain live information from down hole from logging and measurements. The electric line also provides a communication route between the vessel/rig and the equipment in the well.

Wireline is easy to store on a ship, easy to access wells, and easy to do non complicated work with. Example of work done by wireline is logging of cement behind casing or to do inspections on equipment down hole to help determine the barriers. If a well is inclined a tractor may be used to help guide the wireline safely through the bending of the well. A well-tractor is a simple equipment with wheels put on the cable, to easily maneuver the line down hole without damaging equipment or line. Each wheel has its own motor to help the wireline down hole when gravity is not enough, and typically used in long inclined or horizontal parts of the well which is difficult to reach with ordinary wireline operation[13].

For heavier operations coiled tubing or drill pipes can be used, but this requires larger vessels or even rigs to handle both the storing of tubing, and the weight of the operation. Coiled tubing can be used for killing the well by pumping heavy fluid into the well, creating

overpressure to stop the influx from reservoir. It can also be used for the cementing process, both in pumping washing fluid, chemicals, spacers, and the cement itself through the tubing. The bottom hole assembly of the coiled tubing is where all the equipment is placed and can vary for the jobs it is supposed to do. It can contain the same tools that can be hung off on the wireline like logging equipment, and it can also contain equipment used in the cementing process.

Both wireline and coiled tubing (and drill pipe) has a larger set of application in both drilling and intervention, besides the P&A activities mentioned. Because coiled tubing is heavier, larger and more difficult to access well with, the cost is therefore higher than wireline, and it is therefore important to choose equipment based on the job to be done.

Other equipment used in a P&A operation, and especially used for the cementing operation are stinger and wiper darts (**Fig.8**) to avoid contamination from the mud. The stinger is simply a smaller dimension pipe set at the end of the drill pipes when cementing a plug. The use of a stinger has proven to give less contamination between the mud and cement when pulling the pipe out of the hole. The reason is that with smaller diameter pipe, the interference area between the fluids gets smaller, and therefore making them harder to mix.

Equipment also used to avoid contamination is wiper darts or foam balls. These are simply blocking devices used to provide mechanical space between mud and cement. This is in addition to spacer fluid, which also is used to create a fluid hierarchy between mud and cement. These darts or balls are often made out of rubber and are very compressible, which means that they can be pumped down narrow and unregularly places in a well. Mud remains and/or slurry remains on the drill pipe inner walls could often be a source to contamination. By use of diverters some of the remains will be scraped off the wall and prevent some of the contamination. More on the use of wiper equipment under plug setting methods in Section 2.4.

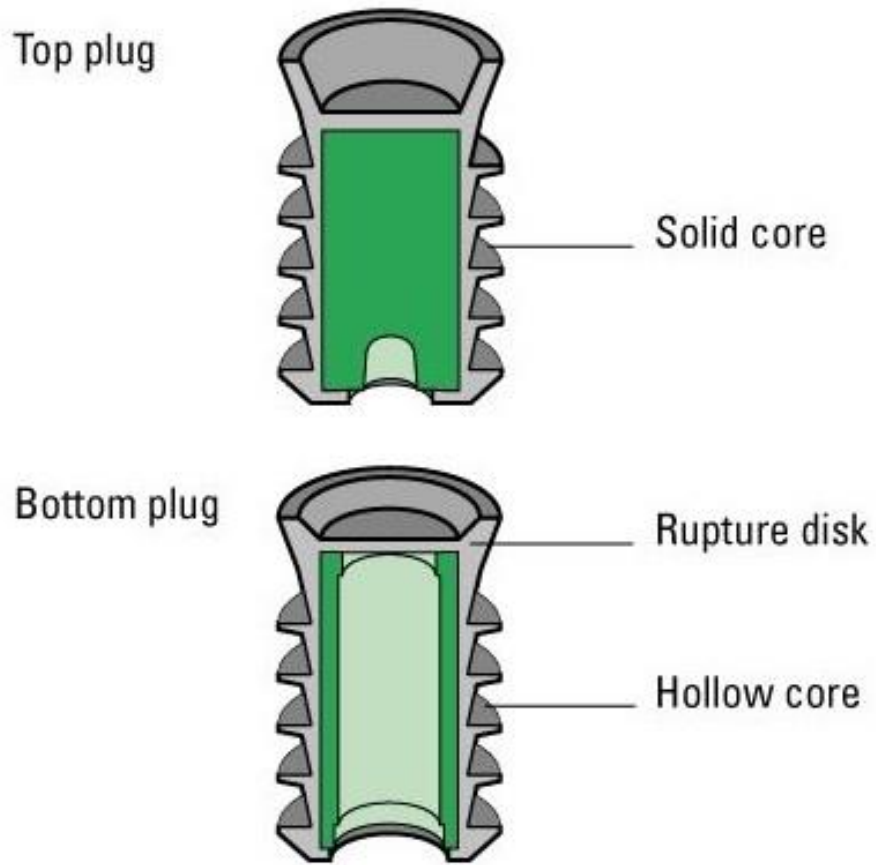

Figure 8: Example of cement wiper plugs.[14]

2.5 Plug setting methods

Because this thesis focuses on setting a cement plug in highly deviated wells, the techniques and methods in this chapter is based on setting a cement plug. There are several ways to set a cement plug, and all the methods have pros and cons depending on the different circumstances and possible problems that are likely to occur. This sub-chapter will be based on the book section in Well Cementing by Daccord et.al [9]

All the different methods are aiming to get as little contamination of drill fluid in the cement as possible. They aim to hit the target depth where the plug should be with right length, and to achieve a top class cement job with high quality cement and good bonding to casing or formation. If all these standards are met, the cement plug will be a success and according to the regulations set by NORSOK[7].

One of the challenges in setting a plug in the middle of a hole is to avoid downwards movement caused by gravity before the cement sets. This is often taken care of by either using a mechanical foundation to base the plug on or by creating a fluid foundation by use of fluids with good rheological properties. Viscous pills containing high gel strength fluid could be one possibility to pump down before setting the plug to create a good foundation for the cement plug. Once the foundation is set, there are several different techniques used today to set the plug, but the most common placing method is balanced plug.

In a balanced plug method (**Fig.9**) a drill pipe (with stinger) is often used to deliver cement at wanted depths of the plug. Before pumping the cement, it is important to clean up the area which will be plugged to avoid both contamination and channels being created. This is often done by applying chemicals to treat the hole. When displacing the mud, it is often followed by spacer to avoid contamination between the mud and cement. It is also important to have appropriate amount of spacer behind the cement to avoid contamination at the end of the plug. Although contamination is taken seriously in this method by applying good mud, cement and spacer hierarchy, it is often the biggest concern using this method.

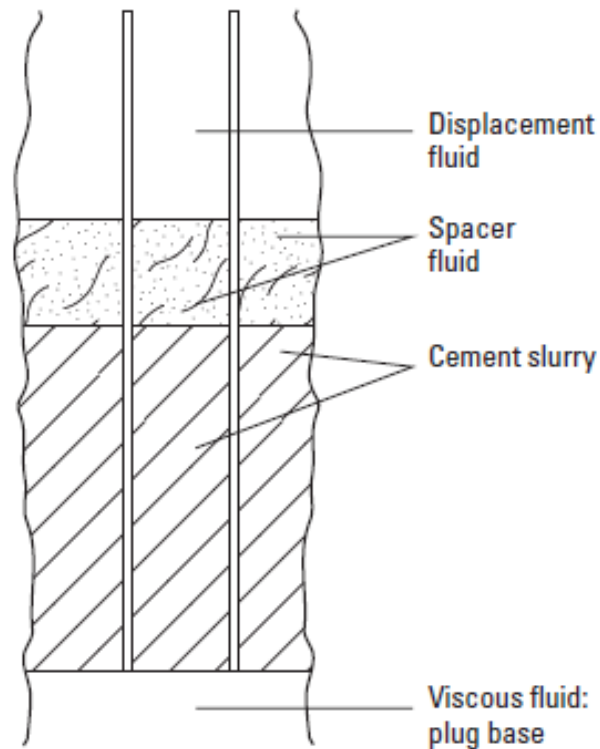

Figure 9: Balanced cement plug [9]

To avoid contamination if this is a big risk in a given cement plug job, it could be more feasible to use other methods like the two plug method or the dump bailer method.

The two plug method (**Fig.10**) uses the same principles as the balanced method with good hierarchy among mud, spacer and cement, but it also provides mechanical barriers between mud and cement through plugs, hence the name. First off chemical wash and spacer are pumped as usual through a drill pipe, but to avoid contamination with cement, a diverter plug is pumped in between the spacer and cement. Another plug is also set behind cement in front of the spacer, separating cement from the displacement fluid following.

Inside the drill pipe a landing device is present to stop the plugs from entering the well. When the first plug enters the landing device, the pressure will build from above the plug until it is broken and cement can flow through it. The procedure with pumping cement continuous until the second plug hits the landing device. This plug will also experience built up pressure which can be measured at surface to indicate when the second plug has reached the locator sub, allowing the cement to be followed by spacer and displacement fluid. The drill pipe (with stinger) is then pulled up above slurry to circulate out excess of cement or other fluids. By use of this method, the cement avoids most of the contact with mud for a great period of travel

time, and therefore minimizing the risk of contamination. It is also beneficial for getting correct setting depth when pulling out of hole.

The outside of a wiper plug is often made out of a type of rubber either from the organic compound Nitrile or Polyurethane, which is both heat resistant and elastic. The core of the wiper plug is made out of plastic to easily both shear the plug when at location in well, and to be able to easily drill out in case of wrongful cementing[15].

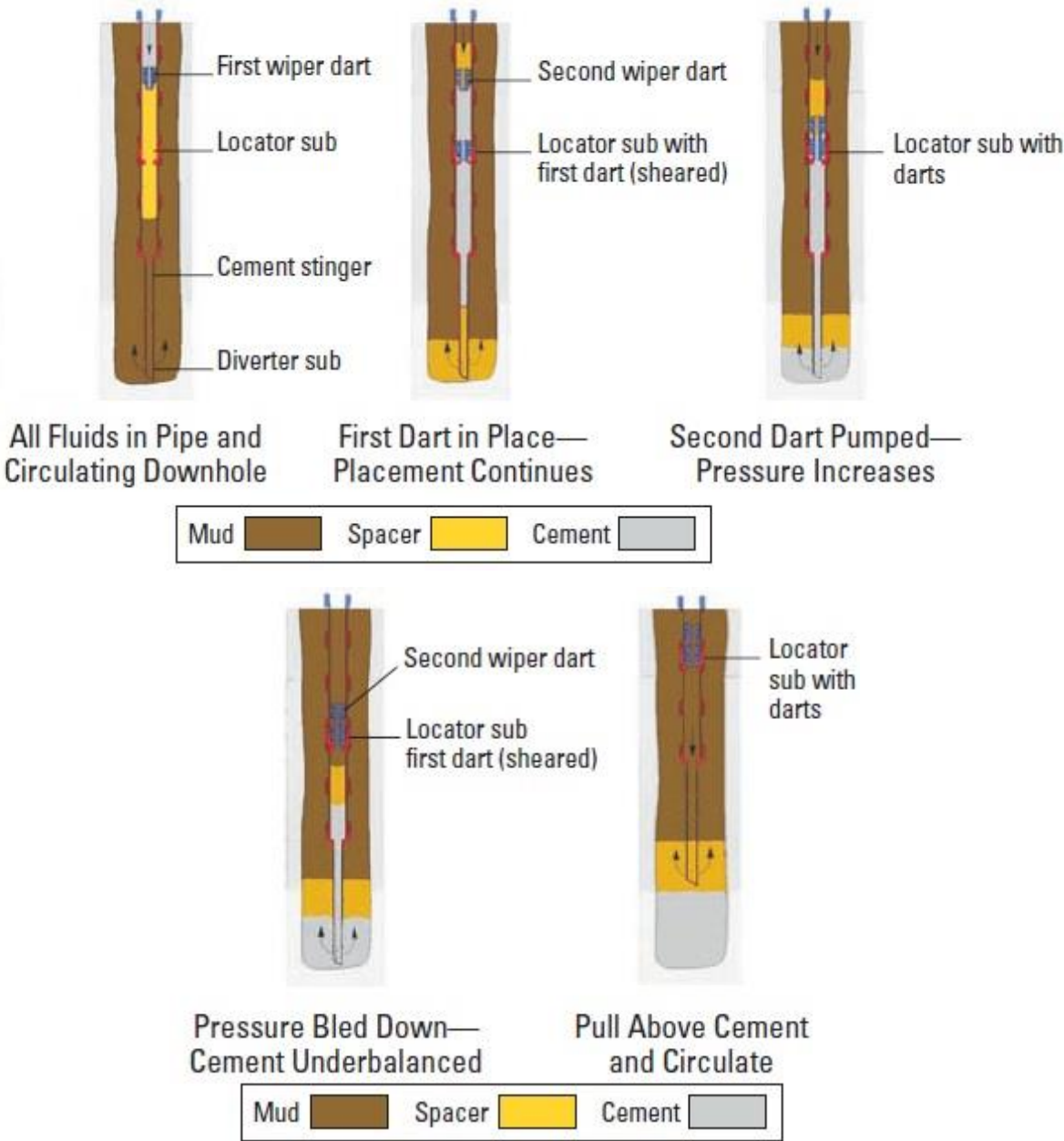

Figure 10: Two plug method [9]

Another great way to avoid contamination is by use of a mechanical shield which represent the dump bailer method. The method is fairly simple, but has its restrictions. The dump bailer (**Fig.11**) uses a tool on a wireline with retainer tubes, which contains large volumes of cement inside it. The retainer tubes is lowered down to wanted setting depth of plug where it either can be opened mechanically by hitting a foundation, or it can be opened electrical either by sending signals. It can also be opened with a predefined setting applied allowing it to be activated after a given time setting. When the retainer tubes are opened, the cement is dumped out onto a foundation, without a large risk of being contaminated during the transport down hole. The dump bailer is either opened at some level above target depth allowing cement to be dumped onto the foundation, or it can be opened at given target depth and slowly pulled upwards when dumping the cement.

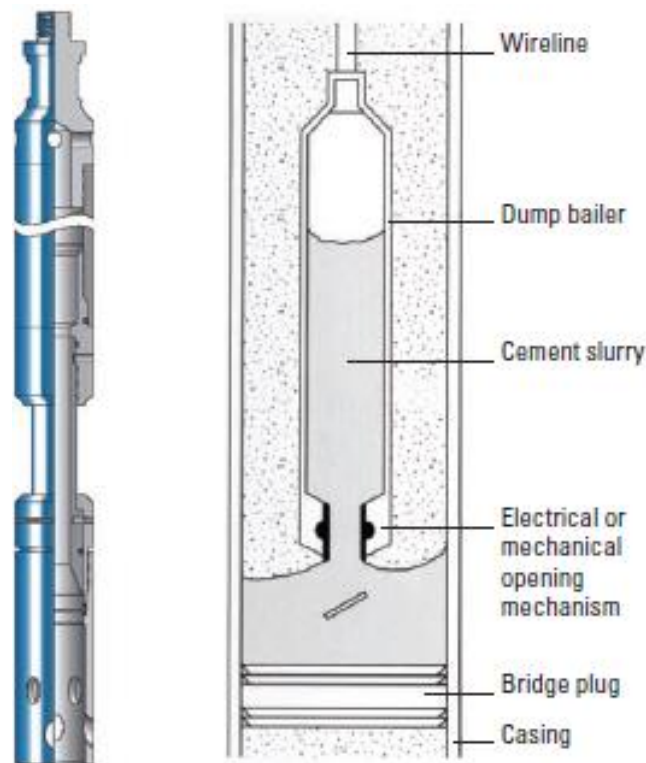

Figure 11: Dump bailer method [9]

There are some limitations to this method as it can only contain a given volume of cement. If the plug requirements through either regulations or hole size require a large volume, it may be too big for the dump bailer. Although several runs can be made, it is not preferable.

To avoid the cement to settle inside the bailer, some special additives have to be added in the cement mix. This could interfere with other rheology properties, and could be a possible problem for this method. In addition to these 3 mentioned methods, there are several other methods and variation used which this thesis will not touch in on.

2.6 Material (Cement)

The most common material used when setting a permanent plug is Portland cement. This may not be the best material in terms of quality, but it is cheap, reliable, easy to work with, and has been used for years with success. Other materials that can be used for plugging are described by Oil & Gas UK[16] as:

- Grouts (non-setting)
- Thermosetting polymers and composites
- Thermoplastic polymers and composites
- Elastomeric polymers and composites
- Formation
- Gels
- Glass
- Metals

These materials have properties that would allow them to be permanent barriers, but there are cons with each of them. The cons can be that the material is expensive, poor placeability, poor strength, poor bonding, etc. Although several new materials are being developed for plugging purposes, Portland cement is still the easiest and most common material to use when setting a permanent plug. The thesis will use Portland cement as plugging material for the simulations.

Portland cement is also common to use in other industries because of its low cost, good quality and availability on raw material. Portland cement is produced from pulverized clinker, which again is a product of mix among limestone, shale (clay), sand and/or other raw materials [17]. The clinker is mixed from the raw materials either in a dry mixing process or a wet mixing process. Either way it is fed into a rotating kiln where the clinker is burned to get rid of waste material that is not needed and to “clean” the clinker. After cooling, the finished clinker is mixed with gypsum creating the finish dry Portland cement product.

3 Methodology and Preparation

To analyze the factors and circumstances causing various problems during cementation of permanent plug in a highly deviated well with OBM, the software “Cementics zonal isolation” by Schlumberger is used. The software is used on a daily basis in cementing operations around the world, and is one of the best software to use when simulating cementing operations.

Cementics allows the user to adjust fluid design, plug design, and job design, meaning that there is enormous amount of changes that can be done to affect the job. The software also allows the use of basic packages of mud, slurries, and spacers to use for purposes like analyzing. The thesis is going to analyzing different aspects of the plugging without being too complex, but focus on some main factors that contribute to success/fail rate on cement plugging in a highly deviated well.

When building up the simulation, Cementics software divides the buildup phase into parts as mentioned: Well design, fluid design, plug design, and job design. This thesis will focus on the plug design part of the software.

Inside the software there is need for a case to be build, and to start a well design has to be created. The well being used for the study is going to represent a real well, but is designed from scratch to represent a general well design. The different data input in the well design needs to easily adjustable. It was essential to be able to investigate the effects of changing inputs, and to see how these affect others, without many factors interfering.

Therefore the well is going to be built as a standard well with conductor, casing and intermediate casing with average “normal” sizes and grades of steel. It will be an open hole completion which is going to be plugged, and the well is going to have an inclination of minimum 60° and a maximum of 90°. The study will be based on a well on the NCS, which means an offshore well with sandstone reservoir.

The fluid design phase in the software allows the user to design the spacer composition, and slurry composition with its properties. It responds to the given mud-composition and well

condition, and suggest choices of fluid composition to achieve best results. The study will also include different fluid-hierarchy (mud-spacer-cement) with experimenting with the use of mechanical spacers like wiper/foam darts in front and behind of the cement.

The plug design phase in the software adapts the plug job to existing fluid and well design, and uses algorithms and calculation to optimize placement (both depth and technique). These calculations are done to reduce the effect of pulling out of hole with respect to contamination of slurry. The thesis will investigate use of different placement techniques like balanced plug and two plug method. It will also investigate the use of different size stingers (both diameter and length). From this point in thesis there will be referred to two stinger types. One normal sized, and one small sized stinger. The difference is both inner and outer diameter which is smaller for the small sized stinger (details described in Section 4.3).

The software will after each simulation round give an outcome with lots of different results like mud circulation, plugging stresses, contamination, circulation of excess slurry, etc. The main focus will be on the quality control of cement slurry, and thereof the contamination risk. The software will provide results in length of good quality cement plug, and which lengths that have medium or high contamination risk.

3.1 Data gathering

When building the well and formation to use for simulation, two common NCS fields were chosen (Norne and Heidrun). These were chosen to create an authentic field (Field X) and well design to use for the simulations. I got both formation data from Norne and Heidrun digitized by Prof Mesfin Belayneh to use for the thesis. These data includes pore and fracture pressures as well as water depth for both fields, which when combined can represent a common NCS field to use for simulation purposes. Norwegian petroleum directorate (NPD) has mapped all the fields in the NCS and Heidrun and Norne are shown in **Fig.12**.

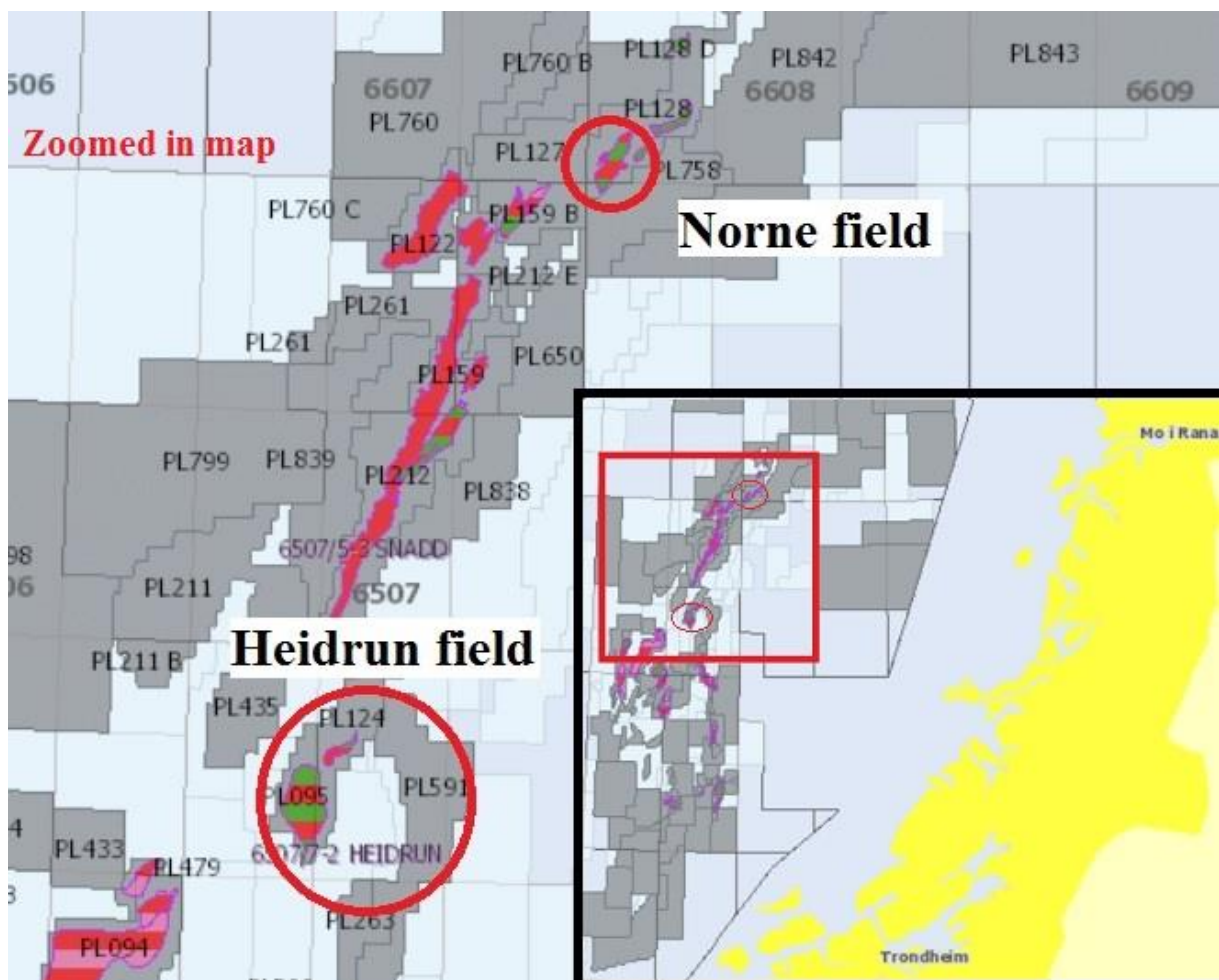

Figure 12: Heidrun and Norne field placement [18]

Other field data from Heidrun and Norne was gathered from NPD fact pages, and in correlation with the formation data gathered from Prof Belayneh, **Table 3** and **Table 4** was created with field data for both fields [19]

Table 3: Heidrun field

Field Data	Value
Water depth	350m
Avg. height sea-level to drill floor	24.0m (one rig with avg. 74m left out)
Reservoir depth	2300m
Avg. temp bottom of well	94,15C
Bottom fracture gradient shale	1,78 SG
Bottom fracture gradient sandstone (reservoir)	1,80 SG
Bottom pore pressure gradient shale	1,28 SG
Bottom pore pressure gradient sandstone (reservoir)	1,11 SG

Table 4: Norne field data

Field Data	Value
Water depth	380m
Avg. height sea-level to drill floor	23.5m
Reservoir depth	2500m
Avg. temp bottom of well	117,00C
Bottom fracture gradient shale	1,86 SG
Bottom fracture gradient sandstone (reservoir)	1,82 SG
Bottom pore pressure gradient shale	1,37 SG
Bottom pore pressure gradient sandstone (reservoir)	1,14 SG

Average values from these fields (Table 3 and Table 4) along with discretion were used to form “Field X” (**Table 5**). This field was used for experimenting on this thesis, and was the basis for all simulations made. It represents a standard NCS field.

Table 5: Field X data

Field Data	Input value
Water depth	365m
Avg. height sea-level to drill floor	23.75m
Reservoir depth	2340m
Avg. temp bottom of well	90C
Bottom fracture gradient shale	1,82 SG
Bottom fracture gradient sandstone (reservoir)	1,81 SG
Bottom pore pressure gradient shale	1,32 SG
Bottom pore pressure gradient sandstone (reservoir)	1,13 SG

3.2 Software data input

When starting the software part “Plug Design”, the first part of the design is to create the well being used. This includes surface descriptions (water depth, density, etc.), tubular design, hole design, and directional survey of the well. Formation inputs and temperature also needs to be designed for to complete the well design part. In the tables below (**Table 6-8**) are some of the most significant inputs made into the software:

Table 6: Plug design data: Surface data

Surface Data	Input value
Rotary table to Seabed depth	388.75 m
Water depth	365 m
Water density	1.027 SG

Table 7: Tubular and Hole design

Tubular design	Input value
Riser length	388.8 meters
Riser OD/ID	21 inch / 19.8 inch
Riser weight	122.2 lb/ft
Casing length	Varies (always 150m above reservoir)
Casing OD/ID	13 inch / 12.3 inch
Casing weight/grade	72 lb/ft / N-80
Hole design	Input Value
Hole length	Varies (from casing shoe down to 10m true vertical depth (TVD) into reservoir)
Hole diameter	8.5 inch
Hole excess	10 %

Table 8: Formation and temperature design

Formation design	Input Value
Shale length (TVD)	388.8-2340 meters
Shale fracture top ED	0.96
Shale fracture bottom ED	1.82
Shale pore top ED	0.96
Shale pore bottom ED	1.32
Sandstone length (TVD)	2340-2350 meters (2355 at some cases)
Sandstone fracture top ED	1.82
Sandstone fracture bottom ED	1.81
Sandstone pore top ED	1.32
Sandstone pore bottom ED	1.13
Temperature design	Input value
Surface temp	10°C
Seabed temp	4°C
Bottom hole static temp	89°C
Rock at reservoir temp	90°C
Bottom hole circulating temp (calculated)	Varies for all different cases. Calculated by software.

3.3 Fluid design

Fluids to be used in the cementing process are the next step to be designed. In this section drilling mud, spacer and cement slurry is designed for (and washing fluid if needed). A fluid database allows the user to import fluids commonly used in operations, and by help from a Schlumberger employee commonly used fluids were chosen to fit the purpose.

The drilling mud selected is important to have the correct density to be able to circulate the well clean before the operation starts. If the mud has too high density, it could end up fracturing the rock formation because of too much pressure inside the well. A mud with a density too low, could lead to a pressure less than the pore pressure, which would result in further influx of formation fluid which is not desirable. The software will calculate for both cases and create a notice if the mud design is inside the drillers window (between pore and fracture pressure).

The spacer designed needs to be able to separate the mud from the cement slurry to avoid contamination. Therefore the spacer fluid has a density higher than the drilling mud, but a lower density than the cement slurry.

The slurry should be designed according to some factors. When placing the cement, the thickening time of the slurry should be designed in a matter that the cement will have time to be placed correctly. When placed correctly it should create an impermeable sealing, which means that the cement must have as low permeability as possible and create high strength at the plug to be able to verify the regulations from NORSOK[7].

The fluids used in the simulation were supposed to be standard fluids used in P&A operations daily. Therefore together with Schlumberger employee Nacera Bourada who works with cementing operations daily, all fluids were designed adjusted to the case. A standard OBM (**Fig.13**) was designed, a standard spacer (**Fig.14**) and standard slurry (**Fig.15**) was created.



Figure 13: Oil based mud design and rheology[20]

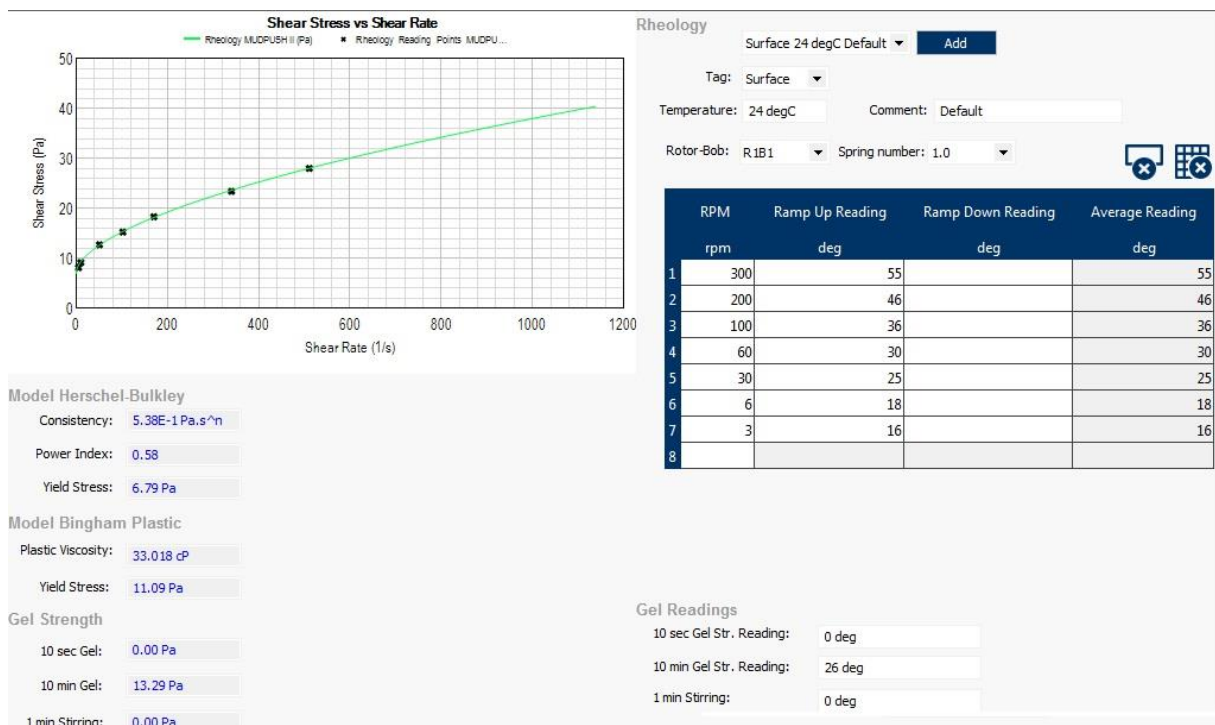

Figure 14: Spacer design and rheology [20]

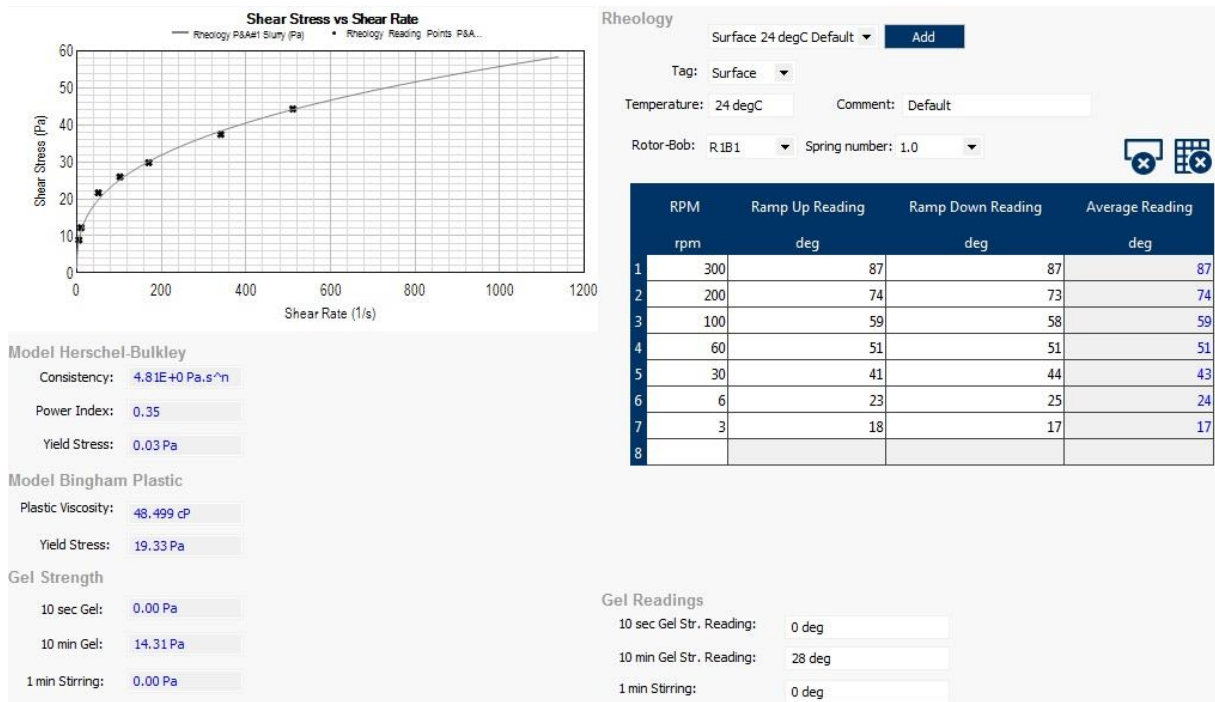

Figure 15: Slurry design and rheology [20]

3.4 Placement design

The first process for the P&A operation is often to circulate the well with the mud used. There are a couple of reasons for doing this. If there is gas or influx present in the well, the first mission for the mud (kill mud) is to circulate out the gas from the well, and stop the well from producing. As important is the circulation to clean up the well from any cuttings or gunk in the well, and to cool the temperature down before plugging. In an open hole completion this circulation needs to be done in a safe matter without fracturing the formation, which means that the mud needs to have a correct density to keep well pressure between the pore and fracture pressure to avoid both influx and fracturing while circulating.

To clean up the well in a correct manner, circulation of mud should be done with at least one full circulation of the entire well. One circulation (bottoms to top) is completed when the pumped down mud (inside drill pipe) reaches the drill floor again through annulus. To calculate this is simple:

- By knowing open hole sizes, the total volume (well + open hole) can be calculated.
- Setting a pump rate [liters/min] and a duration [min] to complete a full circulation of the volume [liters]

When setting the pump rate it is important to consider several factors. A high pump rate will clean the well better, especially in a highly deviated well where it is difficult to clean the well proper. Duration of the circulation will of course also be shorter with a high rate, and time saved equals money saved. There are also cons with using a high pump rate such as a higher rate will add more friction to the system. It will also create a larger load on the surface and down hole equipment. If the objective of the circulation is to kill the well, a lower pump rate would be chosen. A lower circulation rate will allow the kill the well in a safe matter with more well control.[21]

The circulation done in the software takes account for that the well is killed in advance, and is mostly to clean up well. Therefore a pump rate of 3000 [liters/min] is chosen. In a well with a total volume (well + open hole) of 213 [m³] or 213*10³ [liters], would give a total duration of 213000/3000 = 71min to circulate the well bottom to top one time. When changing the well trajectory, the volume will of course also change, but keeping the pump rate constant will allow us to only change duration time. When the volume change, it is important that the

duration parameter is changed so that the number of circulation always corresponds to 1.00 in the software (Fig.16).

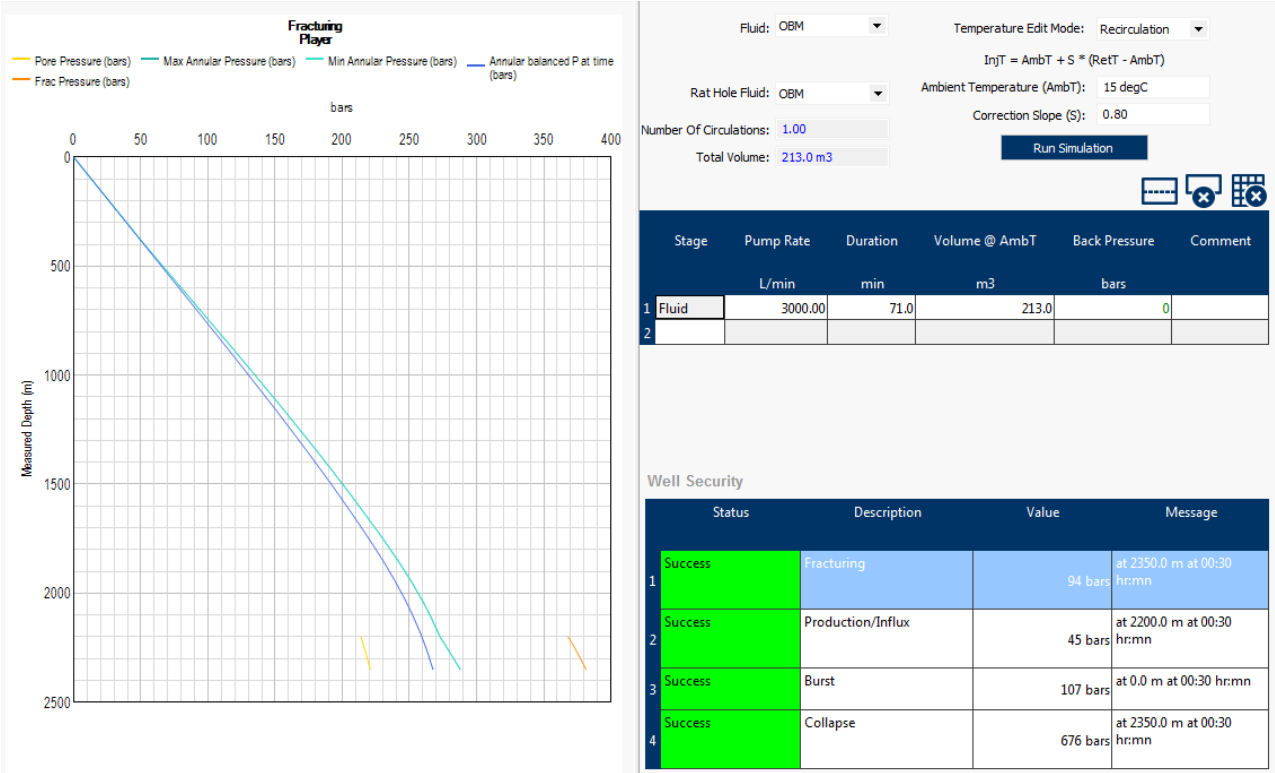

Figure 16: Example of mud circulation results from software

The next step in the software is to optimize volume of spacer and slurry. In this section all the volumes/lengths are chosen of spacer and slurry. According to NORSOK regulations[7] the plug needs to be of at least 100m of good cement from 50meters above potential influx. This would mean if the cementing is supposed to be from bottom of well (top of reservoir) and up, it will require 150m of good cement plus the reservoir length.

It is also a possibility to not cement bottom up from the reservoir, and instead create a foundation for where the cement plug should be placed. This could be either a mechanical foundation like a bridge plug, or a fluid foundation as a heavy viscous pill. To set a foundation to build the plug on is preferable when the reservoir zone is very long. When a well is entering a reservoir in high inclination, the reservoir zone can be drilled quite far into the formation.

When setting a fluid foundation it is designed rheological to hold the cement in place, although there is no guarantee that it will. When building the plug design inside the software,

it will treat the fluid foundation as a solid foundation regardless. The fluid foundation is going to be formed from bottom of reservoir to above the sandstone (reservoir) formation. This will mean that the cement plug starts in impermeable formation (shale) above reservoir, and needs to be 150 meters to follow regulations.

The 150meters comes from that the plug needs to be 50 meters above potential influx (sandstone formation), and 100 meters of good quality cement above these 50 meters. To account for some contamination a cement plug length of 185meters where chosen to be the standard slurry length of each case scenario. 185 meters where chosen after some testing in the simulation to see how much contamination one could account for. This length seemed to be enough to avoid a “bad” plug at each given case, and was a representative cement length to work with.

Spacer volume was also set, and with guidance from Schlumberger employee a total volume of 7.0m^3 was chosen. When spacer was added between the mud and the cement slurry, it was important that there is enough volume of spacer both in front and back of the slurry. The volume in front of the cement slurry needs to be much larger than the spacer volume behind. The fluid hierarchy (mud lightest density and slurry heaviest), could lead to increased risk of contamination in front of the cement slurry caused of gravity. Heavier fluids will push into lighter fluids both from gravitational pressure and from pumping pressure, and has larger risk of mixing. Because of this the design used for spacer was to have $6/7$ (6.0m^3) parts of total volume in front of slurry, and $1/7$ (1.0m^3) parts of total volume behind slurry.

The simulation also performed tests on the difference in using wiper darts, and in the software these are simply marked as pauses between the slurry and spacer.

3.5 Simulation part

The objective of the thesis was to test out how some factors could affect the plugging job of an open hole completion in an highly deviated well with OBM. This was done through simulation, and the factors being investigated were well inclination, stinger sizes and length, and how different plugging techniques can affect the job in different plugging situations.

Well trajectory was varied from 60° inclination up to 90° inclination (horizontal) and different variety of buildup rates (dogleg severity) was chosen. Dogleg severity is the amount of degrees per length the well gets inclined ($DLS = \Delta I / \Delta MD$). Normally DLS is given in degrees inclination per 30m (100ft), and so also in this thesis.

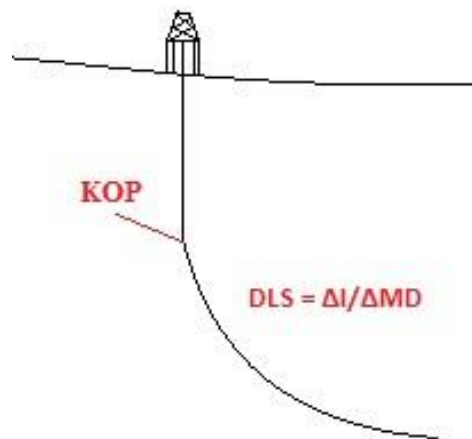

Figure 17: KOP and DLS visualized

The DLS was chosen from a normal low value (1.8degree/30m) up to a normal high value (7.8degree/30m). For different DLS, the kick off point (KOP) for the well will differ to be able to reach target depth (2340m). The KOP is where the well starts to incline like visualized in **Fig.17**. All the wells simulated with the same specific DLS had the same KOP and therefore only the angle when entering the reservoir varied. The Azimuth of the well was not changed and remained 0° for the whole simulation process for simplicity reasons. **Table 9** provides information about the different DLS and angles that was simulated for different scenarios.

Table 9: Simulation process

DLS [degree/30m]	KOP [m TVD]	Angle into reservoir	Total of simulations
1.8	1400	60,70,80,90	4
2.5	1780	60,70,80,90	4
4.2	1945	60,70,80,90	4
6.0	2065	60,70,80,90	4
7.8	2135	60,70,80,90	4

This gives a total of 20 simulations. All the different wells was also tested with 3 different stinger length (150m, 300m, 450m), and with two different inner diameter sizes of the stinger (3,3inch and 3,8inch). In addition there was performed simulation on some of the scenarios with both balanced plug setting and the two plug method.

With different well trajectory and all wells ending up at target depth 2340m (reservoir depth TVD), there will of course be different length on the different wells. To keep some consistency in the well design, all of the wells were designed to end up 10 meters (TVD) into the reservoir. The wells hit the reservoir between 60° and 90°, and regardless of angle, all ended up 10 meters TVD into reservoir. The well trajectory was created in a spreadsheet, varying on different DLS and different angles, creating directional surveys that was imported to the software.

It is common with wells towards horizontal to drain the reservoir in the higher end of the oil zone to secure long and steady production. It is also to avoid water breakthrough taking a water-drive from bottom of reservoir into account. The oil zone at the simulations were assumed to be relative thin, so that is why the wells only enter 10m TVD into reservoir. Regardless of whether the oil zone is 20m, 50m or 100m should not matter for the plug simulations and would not have affected the results.

The well design was also consistent with casing design, allowing shoe to be in shale formation at least 150m MD before reaching reservoir. 150 meters was to ensure 100m of good cement in open hole section with at least 50m above potential influx. Though different inclination entering of reservoir lead to some different open hole length though, it was important to keep consistency in the design to be able to compare.

The simulation process objective was to be able to answer following questions:

- How does different DLS affect the plugging job?
- How does the different inclination of the well affect the plugging job (at different DLS)?
- How can stinger length and size affect plugging jobs at different well trajectory?
- How do the plugging techniques affect the plugging at different scenarios?

3.6 Calculations used in software

Calculation of directional survey uses Minimum Curvature method. This is the most accurate method to calculate TVD, buildup rate, turn rate and DLS in a directional well and is the method used in Cementics Software. The method for computing directional survey uses an algorithm to compute the well trajectory from survey points (or points given in this case). The difference between other methods is that the minimum curvature method calculates both buildup rate and turn rate along with the DLS.

For these thesis simulations, the minimum curvature method was not necessary. Because there is no azimuth change (geographical direction), the buildup rate and DLS will be equal, and no change in turn rate. But for use of real well data where azimuth of course change, the minimum curvature method is the most common to use, and also the method proved to be most accurate.

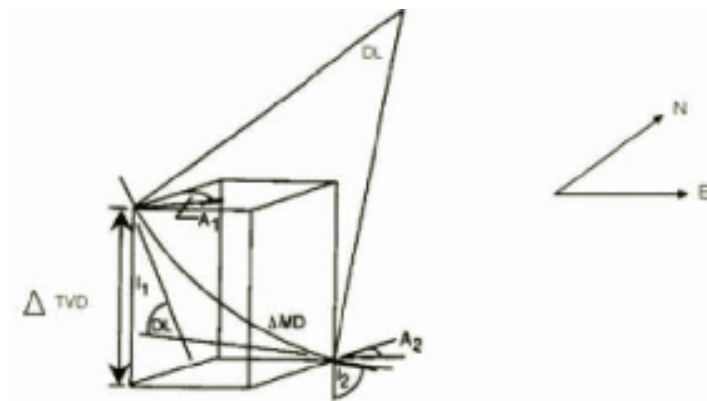

Figure 18: Minimum Curvature Method (from software)

Minimum curvature method uses two survey points to form a circular sphere which forms a smooth curvature between the two points where the DL and TVD can easily be calculated out from as seen in **Fig.18**. The DL is the angle created between the two points radius of the circular figure (If the DL between the two points is divided by the measured depth/length between them, the DLS is found).

4 Results and Discussion

It is important to understand that the results are estimates where the software gives green, yellow and red zones for contamination. The green zone is “guaranteed” not contaminated, and it is these numbers which is presented as barrier length results in the different cases. The barrier length could in many cases be longer than the represented values, but as these values are in the yellow risk area (below 80% chance) for contamination, they cannot be trusted.

4.1 Dogleg severity effect on the cement plugging

By differing DLS for each well, the KOP also had to be adjusted to make sure all the wells ended at least 10meters TVD into the reservoir (2340-2350m). Higher DLS lead to a KOP further down the well, and in theory would higher DLS lead to more difficulty in cleaning of well and displacing of mud. Therefore it was expected better cement plugging and less contamination of cement at the lowest possible DLS. The results in **Table 10** and **Table 11** are combined results for the different DLS with simulations made for all stinger lengths (150-450m).

The results show some agreement with that higher DLS will give more contamination of cement than lower DLS. A higher DLS would lead to a shorter length of good quality cement plug. In worst case a high DLS could if not taken into consideration lead to an unqualified barrier. An unqualified barrier would lead to remedial operation to create a new plug. This could be done by drilling through the old and cementing a new plug, which is very expensive for the operation company.

The barrier length planned for was 185m with good cement and is the amount of slurry pumped, but with some of the slurry contaminated with OBM the final length after POOH is shorter than planned. The objective was to have at least 150m of good cement, and this is why 185m is chosen to consider contamination. The results from the 3,8inch stinger type show barrier length that varies from 141.4 meters (60degree inclination with DLS of 1.8degree/30m) to 174.6 meters (60 degree inclination with DLS of 6.0degree/30m) which is a very big difference! A barrier length of 141.4 meters of good cement is a very contaminated sample, and would not be approved according to NORSOK standards. This cement plug

would need to be done all over with remedial actions, which would give high expenses. The barrier length of ~ 175 meters is a very good cement job with a good quality plug.

There is some inconsistency in the results which was found somewhat surprising. The difference in changing stinger type from 3,8inch ID to a 3,3inch ID changes the results drastically. The results from the “normal” sized stinger with 3,8inch ID shows that most difficulties is within the lowest DLS, and that the higher DLS of 6,0° or 7,8°/30m give the least contamination and best results.

The results with the small diameter stinger (3.3inch ID) show that a DLS of 3.0°/30m give the least contamination on the general basis than the others, and especially in 60-70° region. In the 80-90° inclination region it is the DLS of 4.2°/30m on the small diameter stinger which has the least contamination in general. On the contrary to the results from the normal sized stinger, the highest DLS of 7.8°/30m gives the worst results in terms of contamination. The values vary from 141.5 meters barrier length (80/90 degree inclination at DLS of 1.8 degree/30m) to 177.1 meters length (70 degree inclination at DLS of 3.0°/30m).

Table 10: DLS effect on contamination with normal sized stinger

Normal stinger	1.8degree/30m	3.0degree/30m	4.2degree/30m	6.0degree/30m	7.8degree/30m
60 degree inclination	Highest	Medium	High	Lowest	Low
70 degree inclination	Highest	Medium	High	Lowest	Low
80 degree inclination	High	Medium	Highest	Lowest	Low
90 degree inclination	Medium	Low	High	Highest	Lowest

Table 11: DLS effect on contamination with small sized stinger

Small stinger	1.8degree/30m	3.0degree/30m	4.2degree/30m	6.0degree/30m	7.8degree/30m
60 degree inclination	High	Lowest	Low	Medium	Highest
70 degree inclination	Medium	Lowest	Low	High	Highest
80 degree inclination	Highest	Medium	Lowest	Low	High
90 degree inclination	Highest	Medium	Lowest	Low	High

Discussion

It can be easy to draw conclusions from the different stinger sizes individually, but it is difficult to draw conclusions from the combined results when they are so different. It seems that a faster build of angle (higher DLS) give less contamination of the cement plug than a slower buildup with a normal sized stinger. When the stinger inner diameter decrease, the contamination gets higher at slower buildup rates, and a moderate buildup rate seems to give the best results in terms of contamination of cement, and therefore will give the longest plug length.

With different buildup rate the flow characteristic of the different fluid will vary. A sharper turn in the pipe will give larger difference in velocity for fluid at inner and outer wall of the tubing. Therefore a change in DLS can results in a slight change in flow regime towards either laminar or turbulent. Although it is small changes, it could be enough to affect the cement contamination results when pumping into hole.

A difference in well trajectory will also affect the mud-displacement before cementing the plug. Different flow characteristic will have different effects on both cleaning of mud-remains and displacing the mud to cement. At this stage it is difficult to say exactly how much effect, and this needs to be investigated further to draw conclusions. But that a difference in mud-displacement and cleaning can affect the cement contamination is clear, and therefore a

change in DLS will affect the end result. The results from the simulation are not conclusive enough, and as said needs to be investigated further to draw a fully understanding of the DLS effect on cement contamination.

4.2 Angle of entering of reservoir effect on plugging

With different angles in a well come different challenges. In this thesis where highly deviated wells has been analyzed, a change in inclination from 60° to 90° where simulated through the software. Horizontal wellbore would seem simpler to avoid mixing of fluids and therefore avoiding contamination because there is no gravity between the fluids (90°). In a vertical section the gravity pulls fluids into each other, and without gravitational force it would seem that the chance for mixing of fluids decreases.

Results show for a normal stinger size (**Table 12**) that the contamination is definitely higher at the inclination angle of 60°. At lower DLS (1.8-3.0°/30m) the contamination is lower at higher inclination angles. At higher DLS, the contamination increases at higher angles versus lower angles. When looking at the values from simulation, it shows that in a higher DLS (4.2-7.8) the difference between different angles are very small. Per example in DLS 7.8 it does not differ one meter between the poorest results and the best, which is no significant number. As for the lower DLS the values from poorest to best results can vary with more than 20 meters, so there is a clear change here.

Table 12: Inclination effect on contamination with normal sized stinger

Normal stinger	60 degree inclination	70 degree inclination	80 degree inclination	90 degree inclination
1.8degree/30m	Highest	Medium	Lowest	Lowest
3.0degree/30m	Highest	Medium	Lowest	Lowest
4.2degree/30m	Highest	Lowest	Medium	Medium
6.0degree/30m	Medium	Lowest	High	Highest
7.8degree/30m	Highest	Lowest	Highest	Medium

The results from the small sized stinger (**Table 13**) is somewhat opposite from the results above, but not when looking through the number values from the results. The numbers from the DLS of 3.0 shows that the difference between 60° and 90° inclination is practically zero. The results in Table 13 show that the highest inclination angle gets the highest contamination at low DLS (1.8°/30m), but at all other DLS it proves to be lower contamination of slurry in the higher degrees of inclination as the results from the normal simulation shows (Table 12).

Table 13: Inclination effect on contamination with small sized stinger

Small sized stinger	60 degree inclination	70 degree inclination	80 degree inclination	90 degree inclination
1.8degree/30m	Lowest	Medium	Highest	Highest
3.0degree/30m	Medium	Lowest	Highest	Highest
4.2degree/30m	Highest	Medium	Lowest	Lowest
6.0degree/30m	Highest	Medium	Medium	Lowest
7.8degree/30m	Medium	Medium	Medium	Medium

Discussion

It proves to be correct as assumed that an inclination towards horizontal will give less contamination in the general. Although if just comparing the angles to each other the results vary, but seeing through the numbers from the simulation it shows that there is a clear difference between contamination at low and high angles of deviation.

An explanation as described earlier is the angle the fluid boundaries meet each other. At 90°, the gravitation does not “pull” heavier fluids into lower density fluids, and therefore no mixing of fluids will come from gravitational force. From the results it seems that it is more difficult to avoid contamination at lower deviation angles, and that contamination decreases with increase of angle.

Another explanation is looking at the flow characteristics at the different angles of deviation. A different angle in pipe will affect the flow characteristics caused by gravity, affecting the velocity of the fluid. A fluid in an uphill pipe will have a slower velocity than a fluid in a downhill pipe. Likewise an angled pipe will have faster velocity than a pipe in horizontal position. From fluid mechanics [22] the equation (Eq.3) of average velocity in angled pipe for laminar flow is given by:

$$V = \frac{(\Delta P - \rho * g * L * \sin\theta) * \pi * D^4}{128 * \mu * L} \quad (\text{Eq.3})$$

The equation states that if $\theta < 0$ it will give a higher average velocity to the fluid, which again will give a higher Reynolds number and make the flow more turbulent. Although it is small

changes the results from simulation could prove that a more turbulent flow will give a larger contamination risk because of higher mixing danger when the flow is turbulent of natural causes.

A larger velocity and more turbulent flow will in theory also give better mud-displacement and particle scraping along the inner walls. And an angle of 60° will give better displacement opportunities than a 90° angle, which would in theory lessen the contamination. From the cementing book by Smith [23] it was concluded that mud-displacement was far better in 60° wellbore than 85° with significant smaller mud-channeling. But if the mud is fully displaced in all inclination angles (depends a lot of mud-composure), a higher angle will then give less contamination and a better cement plug.

4.3 Stinger size evaluation

With two different stinger sizes evaluated against each other, it was chosen one “normal” sized stinger suggested by Schlumberger employee with the following characteristics:

OD: 5inch, ID: 3.8inch, weight: 16.6 lb/ft, grade: E75

And one stinger with smaller inner diameter, but similar properties to simply investigate the effect of changing the inner diameter size without other input differences:

OD: 4inch, ID: 3.3inch, weight: 14.0 lb/ft, grade: E75

The different number values from all the results are not that interesting, but the difference between the normal and small size results is very interesting. Therefore a **Table 14** was created to show at which conditions each stinger is preferable. Green for lowest contamination and best plug result with normal sized stinger (3.8inch inner diameter), or red for lowest contamination and best plug result with small sized stinger (3.3inch inner diameter)

Table 14: Stinger size evaluation considering contamination

	60 degree inclination	70 degree inclination	80 degree inclination	90 degree inclination
1.8degree/30m	Small	Small	Normal	Normal
3.0degree/30m	Small	Small	Normal	Normal
4.2degree/30m	Small	Small	Small	Small
6.0degree/30m	Normal	Normal	Normal	Small
7.8degree/30m	Normal	Normal	Normal	Normal

Discussion

From the results it seems that at low DLS, a smaller diameter of the stinger will give less contamination. At a higher DLS, a larger diameter of the stinger will give less contamination. There is significant difference on the length of cement plug between the results of the different scenarios, and it can be concluded that Table 14 shows legit results.

The whole point in using a stinger is that a smaller diameter pipe at the end will give less contamination risk. This because more controlled volumes of fluid is pumped down in the

cementing operation, and the risk of mixing gets less as the interface area between fluids decrease. When increasing the angle of deviation needed to be plugged, the effect of a smaller diameter stinger wears off. When deviation reaches towards horizontal a larger interface area between the fluids can be preferable to be able to “push” the other fluids from toe to heel. This could be preferable instead of having smaller area of entering, where a possible separation could appear. In a separation process, the lighter fluids could go on the high side of the well, and heavier fluids on the low side of the well. This could be the reason why a smaller inner diameter is preferred at angles more towards 60° rather than 90° .

At higher DLS the normal sized stinger is preferred according to the simulation result at almost every inclination angle. Of which reasons the small sized stinger is not preferred here can be correlated to the explanation above. A smaller sized stinger could also lead towards a more turbulent flow. A smaller area inside of pipe could contribute in higher velocity and mixing of fluids. At the same time the smaller diameter will have smaller interfaces with the other fluids.

It could be safe to say that there probably is a limit where the area inside pipe either contributes to more contamination or less contamination, but where this limit is needs further investigation to figure out.

4.4 Stinger length evaluation

The simulations have all been done with 3 different stinger lengths, to check if the industry guideline (according Schlumberger employers) is correct: “The stinger length should be 1.5 times the length of the plug”. In these cases, the cement plug is calculated to be 185 meters long (although it ends up being shorter than that), and by industry guidelines the stinger length should be at least $185\text{m} \times 1.5 = 277.5$ meters. This would mean that a stinger length of 300 meters should be adequate and give the best results in terms of contamination. To test this, a stinger length of 150m, 300m, and 450m were applied to the different cases and tested.

As the results show, a 300m or 450m long stinger will give less contamination and give the best results. A 150m long stinger will give more contamination no matter what well trajectory that is designed. The few examples where 150m long stinger does not have the most contamination, is believed to be a wrongful simulation. The indication from the results is pretty clear in that a 150m long stinger will give far more contamination than the other lengths.

The results from the two tables are given in cement plug lengths with 150m stinger length as reference length, and the difference to the other two lengths. Because the differences between 300m and 450m are very small, it is easier displayed with numbers alongside with colors in **Table 15** and **Table 16** instead of only comparison to each other.

Table 15: Stinger length differences effect on plug length with normal sized stinger

	150m Normal stinger	300m Normal stinger	450m Normal stinger
1,8degree/30m 60 degree inc.	0	-21,2m	-21,3m
1,8degree/30m 70 degree inc.	0	+1,1m	+2,8m
1,8degree/30m 80 degree inc.	0	+1,8m	+1,7m
1,8degree/30m 90 degree inc.	0	+1,8m	+1,7m
3,0degree/30m 60 degree inc.	0	+1,9m	+2,1m
3,0degree/30m 70 degree inc.	0	+1,4m	+1,2m
3,0degree/30m 80 degree inc.	0	+1,4m	+1,3m
3,0degree/30m 90 degree inc.	0	+1,4m	+1,3m
4,2degree/30m 60 degree inc.	0	+1,3m	+3,0m
4,2degree/30m 70 degree inc.	0	+0,5m	+0,8m
4,2degree/30m 80 degree inc.	0	+1,4m	+1,7m
4,2degree/30m 90 degree inc.	0	+1,4m	+1,7m
6,0degree/30m 60 degree inc.	0	+2,9m	+2,6m
6,0degree/30m 70 degree inc.	0	+1,6m	+1,9m
6,0degree/30m 80 degree inc.	0	+3,6m	+3,9m
6,0degree/30m 90 degree inc.	0	+1,6m	+1,4m
7,8degree/30m 60 degree inc.	0	+1,4m	+1,6m
7,8degree/30m 70 degree inc.	0	-0,2m	0
7,8degree/30m 80 degree inc.	0	+1,4m	+1,6m
7,8degree/30m 90 degree inc.	0	+1,6m	+1,6m

Table 16: Stinger length differences effect on plug length with small sized stinger

	150m Small D stinger	300m Small D stinger	450m Small D stinger
1,8degree/30m 60 degree inc.	0	+1,4 m	+1,7m
1,8degree/30m 70 degree inc.	0	+1,1m	-15,3m
1,8degree/30m 80 degree inc.	0	+2,7m	+2,6m
1,8degree/30m 90 degree inc.	0	+2,7m	+2,6m
3,0degree/30m 60 degree inc.	0	+3,5m	+3,1m
3,0degree/30m 70 degree inc.	0	+3,5m	+5,0m
3,0degree/30m 80 degree inc.	0	-8,7m	-8,7m
3,0degree/30m 90 degree inc.	0	-8,7m	-8,7m
4,2degree/30m 60 degree inc.	0	+1,5m	+1,3m
4,2degree/30m 70 degree inc.	0	+2,6m	+2,7m
4,2degree/30m 80 degree inc.	0	+2,6m	+2,7m
4,2degree/30m 90 degree inc.	0	+2,6m	+2,7m
6,0degree/30m 60 degree inc.	0	+1,5m	+2,9m
6,0degree/30m 70 degree inc.	0	+1,0m	+1,0m
6,0degree/30m 80 degree inc.	0	+1,0m	+1,0m
6,0degree/30m 90 degree inc.	0	+1,8m	+1,4m
7,8degree/30m 60 degree inc.	0	+1,5m	+1,7m
7,8degree/30m 70 degree inc.	0	+1,5m	+1,8m
7,8degree/30m 80 degree inc.	0	+1,5m	+1,8m
7,8degree/30m 90 degree inc.	0	+1,5m	+1,8m

Discussion

Both the results from the small diameter stinger and the normal sized stinger go a long way in confirming the industry guidelines. With there not being big differences between the 300m stinger and 450m stinger, it seems that it is unnecessary to have a stinger length much longer than the 1.5times the length of cement plug. For a stinger length of 150 meters it gives more contamination, and ends up with a shorter cement length than with the use of a stinger with length 300meters. The results was as expected and had no particular deviation between the different dimension (inner diameter) of stingers.

The few results where the stinger at 300m and 450m gets far more contamination than the 150m stinger, is assumed to be false results where something went wrong. These don't correlate with the results with similar values, and really does not make sense. So it is safe to conclude with that a stinger length of 1.5 times the plug length is a good length, and that a shorter length should not be recommended.

4.5 Balanced plug vs. two plug method

When analyzing balanced plug method vs. two plug method, the number values from results were analyzed to give an understanding of the wiper darts/foam balls effect on contamination. All different DLS were used with both 60 degree inclination into reservoir and 90 degree inclination into reservoir. To standardize the testing, a normal sized stinger type were used in the simulation with a length of 300m. This stinger length follows industry guideline for length of stinger to be 1.5 times the length of the plug.

In **Table 17**, the color green represents for when balanced plug gives lowest contamination and the red for when the two plug method gives the lowest contamination. The yellow color for when there is no difference, or very small insignificant difference between the results of the two plugging methods.

Table 17: Best plugging method in terms of plug length results

	60 degree inclination	90 degree inclination
1,8degree/30m	Two plug method	No difference
3,0degree/30m	Two plug method	Balanced plug
4,2degree/30m	Two plug method	Two plug method
6,0degree/30m	No difference	Two plug method
7,8degree/30m	No difference	No difference

Discussion

As expected does the two plug method give either similar result as the balanced plug or better in the most cases. The two plug method is an effective way to separate the fluids mechanically and therefore one should automatically expect less contamination. Apart from separating fluids, the wiper darts/balls also rinse the inner wall of the tubing for mud. This also contributes to less contamination risk of cement interfering with old mud remains.

The choices of plug method should always be run through simulator and tested, but in doubt the simulations show that in wells with deviation from 60° to 90°, the two plug method is the best out of the two methods. There are though more complexity with this method and more cost.

5 Conclusion and Further Work

The P&A field is definitely something that needs further work. Nowadays, the plugging operations are far too expensive, and soon many of the wells on NCS need to be abandoned. This thesis did not contain the money issue which is very topical in today's business, but operations leading to an incomplete plug. An incomplete plug also contributes to the expense of the abandonment operation, and is not preferable. This is why it is important to get rid of problems occurring that could lead to an incomplete barrier sealing. What is important then is to know which factors contribute to a faulty operation?

This thesis has investigated the well trajectory, stinger choice and plugging method, to see how they affect the cement results in both quality and length. Some of the results have been concluding, and some needs further investigation to conclude something from.

The results from simulation show that different DLS give different results in terms of contamination. There is safe to say that there are more factors that contribute to these results, and it is therefore not possible to conclude in which DLS give the least contamination. When investigating the angle of inclination effect, the results showed coherencies. In terms of contamination, an angle towards horizontal (90°) will give better results, and contribute to a longer cement plug. An angle towards 60° will in most cases have more risk for contamination of cement, and give shorter plug lengths.

Stinger size and length evaluation is difficult. Even though results show that a smaller diameter stinger is preferred at lower DLS, and a larger diameter stinger at higher DLS, it is difficult to conclude anything. But in terms of length it can be concluded that a stinger length of minimum 1.5 times the cement plug will give the best results in terms of contamination. A longer stinger can be preferred at some cases, but overall a stinger length of 1.5 times the cement plug is the optimum.

The two plug method in a highly deviated well displaced in OBM is preferred in most of cases instead of balanced plug. By mechanically separating the slurry from the other fluids provides better results in both contamination and plug length.

To investigate further the effect of well trajectory, stinger choice and plugging method it could be an idea to use real well data in large scale (all the wells on NCS for example). Then it could be an idea to compare the plugging results gathered from simulation with software like Cementics or similar. This requires a lot of work and data, but will give more clear results in real life wells in which factors influence the plugging operation. An idea is also to gather information from plugging operations already done, and compare the same factors. The cementing results from real life wells could also be simulated in software to conclude even further and compare results.

There are a lot of work that can be done to find out which factors contribute to failure in cement plugging in a highly deviated well displaced in OBM. It will be time consuming and require a lot of effort, but the results could lead to less contamination and quality problems in future cement plugging operations. Together with future technology it could contribute to reduce the cost of abandonment operations, and of course reduce the risk for environmental damage. This would benefit the whole industry with decrease in cost and increase in HSE.

6 References

- [1] I. Isgenderov, S. Taoutaou, I. Kurawle, A. M. Mesa, and T. Khan, "Modified Approach Leads to Successful Off-Bottom Cementing Plugs in Highly Deviated Wells in the Caspian Sea," presented at the SPE/IATMI Asia Pacific Oil & Gas Conference and Exhibition, 20-22 October, Nusa Dua, Bali, Indonesia, 2015.
- [2] N. Henriksen, "Drilling engineers in Wintershall view on today's problems," K. T. Borsheim, Ed., ed, 2015.
- [3] E. B. Nelson and D. Guillot, *Well Cementing Second Edition* vol. Second Edition. Sugar Land, Texas: Schlumberger, 2006.
- [4] R. J. Crook, S. R. Keller, and M. A. Wilson, "Deviated Wellbore Cementing: Part 2 Solutions," *Journal of Petroleum Technology*, vol. 39, pp. 961 - 966, 1987.
- [5] S. R. Keller, R. J. Crook, R. C. Haut, and D. S. Kulakofaky, "Deviated-Wellbore Cementing: Part 1 - Problems," *Journal of Petroleum Technology*, vol. 39, pp. 955 - 960, 1987.
- [6] D. Schlumberger, "Remedial placement techniques," in *Cementing technology*, ed London: Nova Communications Ltd, 1984, p. 17.
- [7] S. Norway, "Abandonment activities," in *NORSOK Standard D-010: Well integrity in drilling and well operations*, Rev. 4 ed: Standards Norway, 2013, pp. 81-111.
- [8] C. Vipulanandan, M. Heidari, Q. Qu, H. Farzam, and J. M. Pappas, "Behavior of Piezoresistive Smart Cement Contaminated with Oil Based Drilling Mud," presented at the Offshore Technology Conference, 05-08 May, Houston, Texas, 2014.
- [9] G. Daccord, D. Guilloot, and S. James, "Remedial Cementing," in *Well Cementing Second Edition*. vol. Second Edition, E. B. N. a. D. Guillot, Ed., ed Sugar Land, Texas: Schlumberger, 2006, pp. 513-521.
- [10] F. Moeinikia, K. K. Fjelde, A. Saasen, T. Vralstad, and O. Arild, "Evaluating Cost Efficiency of Rigless P&A for Subsea Multiwell Campaign."
- [11] O. a. G. UK, "Classifying Wells and Abandonment Cost Estimation," in *Guideline on Well Abandonment Cost Estimation*. vol. Issue 1, O. a. G. UK, Ed., ed: Oil and Gas UK, 2011, pp. 15-23.
- [12] I. Offshore. (2016). *Mou Island Constructor*. Available: <http://www.islandoffshore.com/fleet/fleet-overview/rlwi/island-constructor>
- [13] C. Kruger, "The Challenges of Deviated Wells," presented at the SPE/IADC Middle East Drilling and Technology Conference, 22-24 October Cairo, Egypt, 2007.
- [14] Schlumberger. (2016). *Oilfield glossary: Wiper plug*. Available: http://www.glossary.oilfield.slb.com/Terms/w/wiper_plug.aspx
- [15] E. L. J. M. J.-L. Pessin, "Cementing equipment and casing hardware," in *Well Cementing Second Edition*. vol. Second Edition, E. B. N. a. D. Guillot, Ed., ed Sugar Land, Texas: Schlumberger, 2006, pp. 49-90.
- [16] T. u. k. o. o. a. g. i. a. limited, "Material types - specific experimental work plans," in *Guidelines on qualification of materials for the suspension and abandonment of wells*. vol. Issue 1, T. u. k. o. o. a. g. i. a. limited, Ed., ed London: Oil & gas UK, 2012, pp. 52-70.
- [17] E. B. Nelson and M. Michaux, "Chemistry and characterization of Portland Cement," in *Well Cementing Second Edition*. vol. Second Edition, E. B. N. a. D. Guillot, Ed., ed Sugar Land, Texas: Schlumberger, 2006, pp. 23-48.
- [18] N. P. Directorate. (2016). *NPD Facts map*.

- [19] N. P. Directorate. (2016). *NPD Fact pages*.
- [20] N. Bourada, "Fluid design in Cementics," ed, 2016.
- [21] R. D. Grace. *Blowout and well control handbook*. Available:
<http://www.drillingformulas.com/slow-circulation-rate-sc/>
- [22] Y. A. Cengel and J. M. Cimbala, "Internal flow," in *Fluid mechanics: fundamentals and applications*, S. edition, Ed., ed New York USA: The McGraw-Hill Companies, 2006, pp. 337-367.
- [23] D. K. Smith, "Primary Cementing," in *Cementing*. vol. Monograph volume 4, ed USA: Society of petroleum engineers Inc., 1990, pp. 98-102.

Appendix A

This appendix contains an example report from Cementics simulation. The uninformative pages from the report have been removed, and this is a report for one single simulation. The example report is from the simulation with well inclination of 70° , a DLS of $4.2^\circ/30\text{m}$ and 300 meter normal sized stinger.

Plug Operation Summary

Overview of the cementing operation (temperatures, fluid types, rates and general notes)
All depths take the rig floor as reference

Table A.1: Plug operation summary: Well and rig information

Well & Rig Information					
Rig Type :	Offshore	Objective :			
Section MD :	2510.0 m	Mud Returns :	Rig Floor	Water Depth :	365.0 m
Section TVD :	2351.8 m	Mud Returns Depth :	0.0 m	Air Gap :	23.8 m
Well deviation :	70 deg	Mudline Depth :			

Table A.2: Plug operation summary: Placement

Placement & Post-Placement Conditions					
Top :	2290.0 m	Mechanical Separator :		POOH depth :	2064.0 m
Length :	185.0 m			POOH Speed :	
Bottom :	2475.0 m	Pipe Rotation / Reciprocation :		Circ. rate :	3000.00 L/min
Support :				Circ. direction :	Direct
String type and configuration :					

Table A.3: Plug operation summary: Design considerations

Design Considerations					
P&A#1 Slurry		MUDPUSH II		OBM	
Cement Type :	Slurry	Spacer Type :	Spacer	Mud Type :	Oil Based Mud
Slurry Dens. :	1.92 SG	Spacer Dens. :	1.60 SG	Mud Dens. :	1.32 SG
Volume Balance Model :	Optimize Slurry & Spacer			Underdispl. :	0.7 m3

Table A.4: Plug operation summary: Pumping schedule

Pumping Schedule					
Fluid Name	Stage Volume m3	Pump Rate L/min	Stage Time hr:mn	Comment	Inj. Temp. degC
MUDPUSH II	6.1	1000.00	00:06		20
P&A#1 Slurry	8.7	750.00	00:12		20
MUDPUSH II	0.9	1000.00	00:01		20
OBM :	23.2		00:20		
> OBM	20.0	1500.00	00:13		20
> OBM	3.2	500.00	00:06		20

Table A.5: Plug operation summary: Temperature simulation

Temperature Simulation			
Pre-job Circ. Rate :	3000.00 L/min	BHST	89 degC
Pre-job Circ. Time :	01:14 hr:mn	Simulated BHCT	46 degC

Well Data Summary

The cementing program incorporates the following data:

All depths take the rig floor as reference

Section MD :	2510.0 m	Mud Returns :	Rig Floor	Water Depth :	365.0 m
Section TVD :	2351.8 m	Mud Returns Depth :	0.0 m	Air Gap :	23.8 m
				Mudline Depth :	388.8 m

Table A.6: Well data summary: Tubular and Casing data

Tubulars and Casing Hardware									
	MD m	OD inch	Weight lb/ft	Grade	ID inch	Thread	Collapse bars	Burst bars	Joint m
Riser	388.8	21	122.2		20		0	0	12.2
Prev Casing	2325.0	13	72.0	N-80	12		184	371	1.0
Workstring	2175.0	6	24.7	E75	5		721	683	1.0
	2475.0	5	16.6	E75	4		716	678	12.2
End of String		Type :			S/N :				
Dart/Ball Launch Manifold									

Note : previous casing (and riser) collapse and burst security not verified

Table A.7: Well data summary: Open hole data

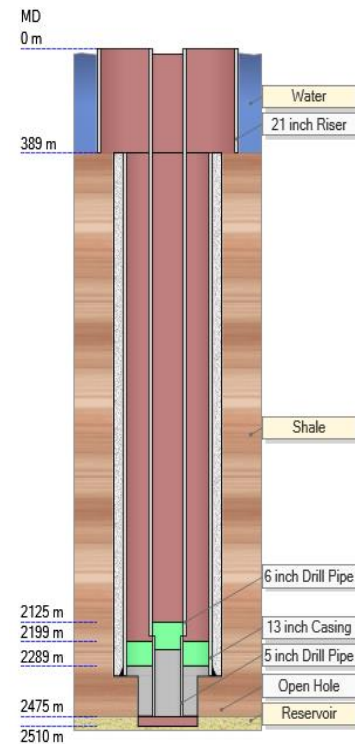

Open Hole			
Total OH Volume :	6.8 m3	Mean Diameter :	8.5 inch
Minimum Diameter :	8.5 inch	Mean Ann. Excess :	0.0 %
Maximum Diameter :	8.5 inch	Mean Eq. Diameter :	8.9 inch

Note : OH caliper was uploaded.

Figure A.1: Well data summary

Directional Survey

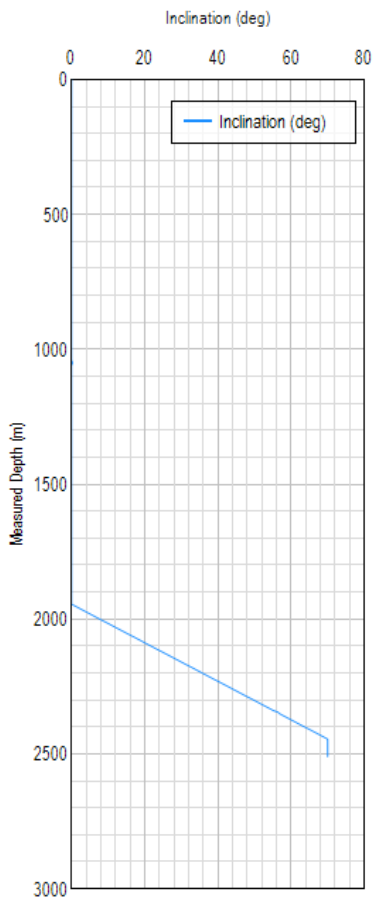

Figure A.2: Well data summary: Inclination

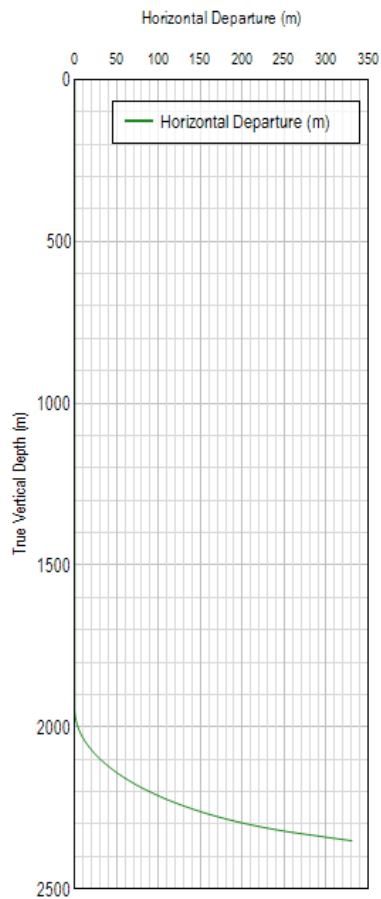

Figure A.3: Well data summary: Horizontal departure

Note : Directional survey was uploaded

Table A.8: Well data summary: Formation data

Formation									
Top MD m	Bottom MD m	Bottom TVD m	Frac Top ED SG	Frac Bottom ED SG	Pore Top ED SG	Pore Bottom ED SG	Lithology	Res. Fluid	Name
388.8	2475.0	2339.8	0.96	1.82	0.96	1.32	Shale		Shale
2475.0	2510.0	2351.8	1.82	1.81	1.32	1.13	Sandstone	Oil	Reservoir

Table A.9: Well data summary: Temperature table

Temperature							
Name	Top MD m	Bottom MD m	Bottom TVD m	Temperature degC	Temp. Gradient degC/100 m	Temp. Rel. Gradient degC/100 m	Sea Current m/s
Surface	0.0	0.0	0.0	10	0.00		0.00
SeaLevel	0.0	23.8	23.8	10	0.00	0.00	0.00
SeaBed	23.8	388.8	388.8	4	-1.50	-1.60	0.05
BHST	388.8	2475.0	2339.8	89	3.38	4.35	0.00
Rock	2475.0	2510.0	2351.8	90	3.38	4.35	0.00

Source of temperature data : Horner-plot based on logging temperatures

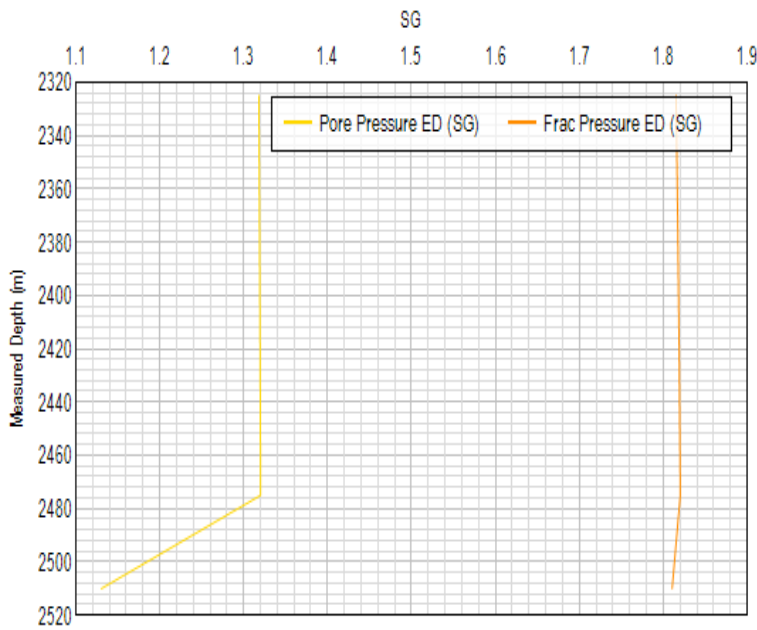

Figure A.4: Well data summary: Pore and Frac pressure

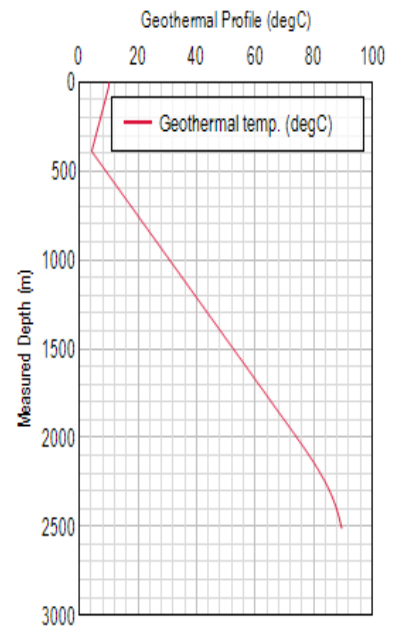

Figure A.5: Well data summary: Geothermal profile

Fluids Summary

Table A.10: Fluids Summary: Fluids

Fluids						
Type	Name	Density SG	Conditions	K Pa.s^n	n	Ty Pa
Drilling Fluid	Mud	1.30	Surface 24 degC Default	1.06E+0	0.48	2.16
Slurry	P&A#1 Slurry	1.92	Surface 24 degC Default	4.81E+0	0.35	0.03
Spacer	MUDPUSH II	1.60	Surface 24 degC Default	5.38E-1	0.58	6.79
Drilling Fluid	Mud Pill	2.00	Surface 24 degC Default	1.06E+0	0.48	2.16
MI-SWACO DF	OBM	1.32	*	1.37E-1	0.88	4.00

* Rheology and density of compressible fluids are displayed at standard conditions, ie. **P = 1 atm** and **T = 20 degC** (65 degF)

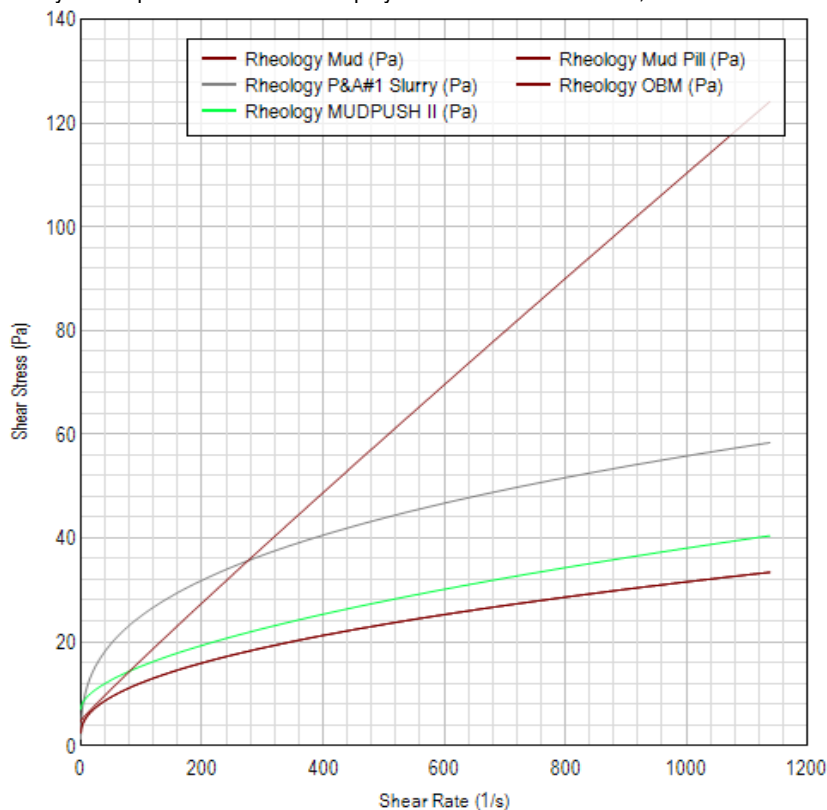

Figure A.6: Fluids summary: Rheology profiles

Table A.11: Fluids Summary: Density and rheology tolerance

Fluid Density and Rheology Tolerance	
Mud – properties to be verified prior to job with mud engineer, contact engineer onshore if deviation is outside the range below	
density difference from planned : +/- 0.1 ppg	rheology difference from planned : +/- 10%
Spacer – properties to be verified prior to job, see contingency plans if deviation is outside the range below	
density difference from planned : +/- 0.1 ppg	rheology difference from planned : +/- 10%
Slurry – cement slurry should be batch mixed within the range described below, see contingency plans if there is mismatch between designed density and slurry volume	
density difference from planned : +/- 0.1 ppg	

Mud Circulation

Fluid	OBM
Number of Circulation	1.00
Total Volume at Ambient Temperature	222.0 m3
Ambient Temperature	15 degC
Correction Slope	0.80

Table A.12: Mud circulation: Pumping stages

Pumping Stages					
Fluid	Pump Rate L/min	Duration hr:mn	Volume m3		
OBM	3000.00	01:14	222.0		
Pumping Stages					
Fluid	Pump Rate L/min	Duration hr:mn	Volume m3	Backpressure bars	Injection T degC
OBM	3000.00	01:14	222.0	0	20

Table A.13: Mud circulation: Well security

Well Security				
Status	Description	Min Differential Pressure bars	At Depth m	At Time hr:mn
Success	Fracturing	102	2325.0	01:14
Success	Production/Influx	3	2475.0	01:14
Success	Burst	569	0.0	01:14
Success	Collapse	671	2475.0	01:14

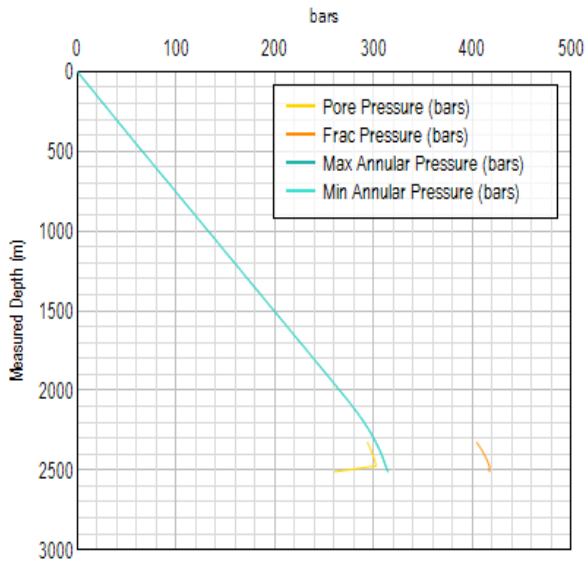

Figure A.7: Mud circulation: Max pressure inside pore and frac pressure

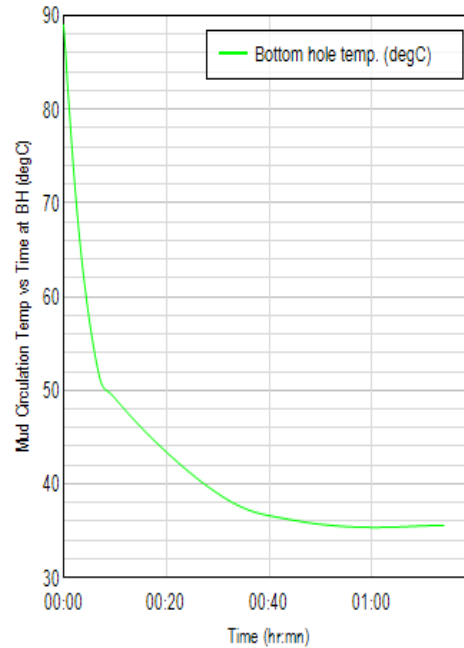

Figure A.8: Mud circulation: Bottom hole temperature

Fluid Placement

Table A.14: Fluid placement: Volume balance objectives

Volume Balance Objectives					
Volume Balance Model: Optimize Slurry & Spacer					
Original Fluid:	OBM	Rat Hole Fluid:	Mud Pill	Displ. Fluid:	OBM
Top Spacer:	MUDPUSH II	set Total Volume to:	7.0 m3		
Top Slurry:	P&A#1 Slurry	set Length to:	185.0 m		
Annulus is filled during POOH.					
Volume Balance Results					
String Volume:	26.3 m3	Underdispl.:	0.7 m3	Displ. Volume:	23.2 m3
TOC after POOH:	2290.0 m	Cement Length after POOH:	185.0 m		

Table A.15: Fluid placement: Fluid placement in annulus and pipe

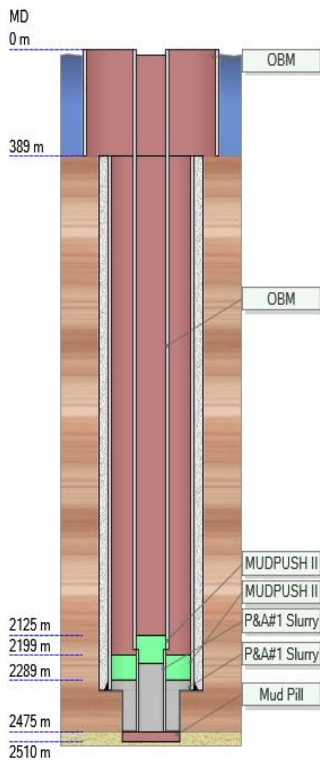

Fluid Placement in Annulus					
Fluid Name	Top MD m	Bottom MD m	Length m	Volume m3	Surface Density SG
OBM	0.0	2198.6	2198.6	183.1	1.33
MUDPUSH II	2198.6	2289.2	90.6	6.1	1.60
P&A#1 Slurry	2289.2	2475.0	185.8	6.9	1.92

Fluid Placement in Pipe					
Fluid Name	Top MD m	Bottom MD m	Length m	Volume m3	Surface Density SG
OBM	24.2	2124.9	2100.7	23.2	1.33
MUDPUSH II	2124.9	2226.3	101.3	0.9	1.60
P&A#1 Slurry	2226.3	2475.0	248.7	1.8	1.92

Figure A.9: Fluid placement: Fluid placement in well

Note: Surface densities of compressible fluids are calculated at surface conditions, ie. $P = 1 \text{ atm}$ and $T = 10 \text{ degC}$

Static Pull Out Of Hole (POOH)

Table A.16: Static POOH: Summary

POOH Summary				
Final DP depth :	2064.0 m		Theoretical Top of Plug:	2290.0 m
POOH Length :	411.0 m		Theoretical Plug Length :	185.0 m
POOH Speed :	TBC		Plug Bottom :	2475.0 m
Top of uncontaminated cement after POOH :			2290.0 m	
Uncontaminated cement length after POOH :			185.0 m	
Contaminated cement length after POOH :			0.0 m	

POOH Results Summary

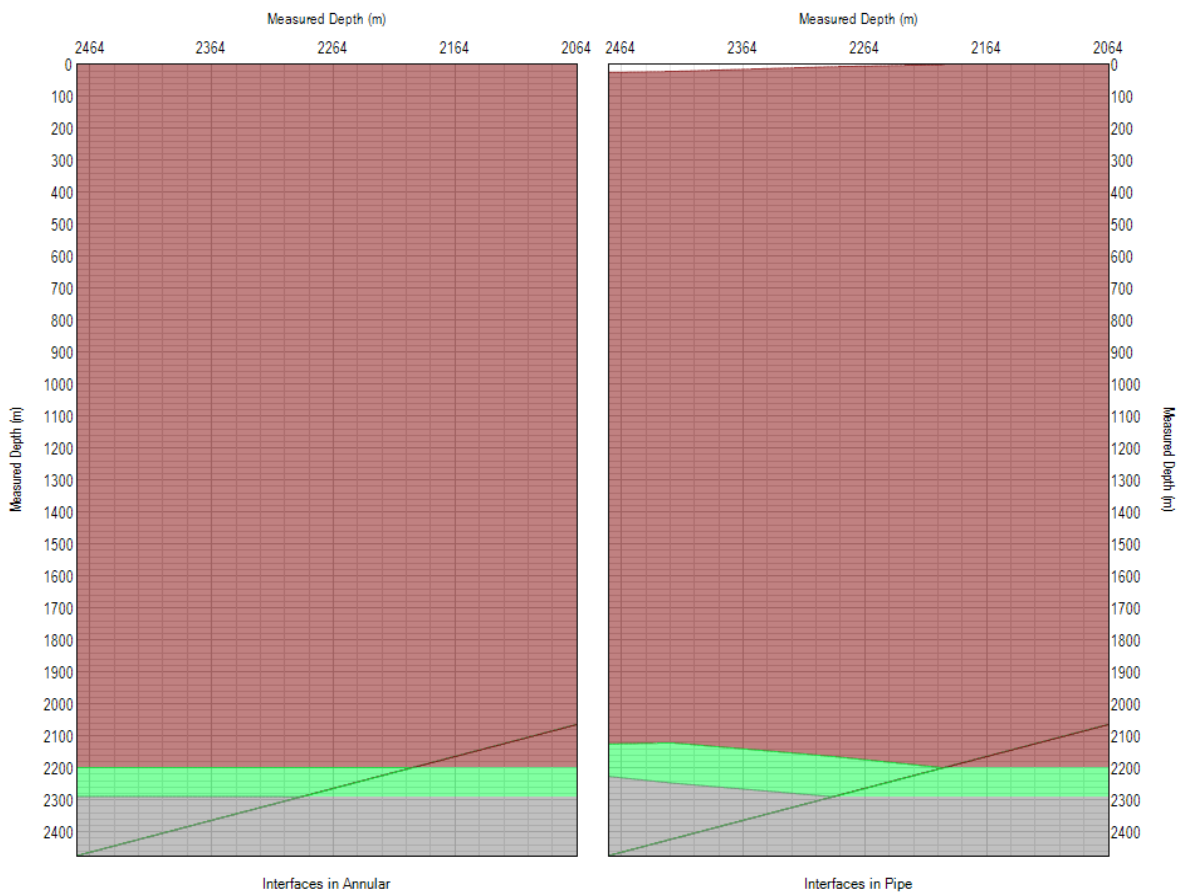

Figure A.10: Static POOH: POOH result summary

Note : Simulation assumes that fluids are free to balance themselves.

Pumping Schedule

Volume and rate of compressible fluids are calculated at surface conditions, ie. **P = 1 atm** and **T = 10 degC**

Table A.17: Pumping schedule

Pumping Schedule						
Fluid Name	Stage Volume m3	Pump Rate L/min	Stage Time hr:mn	Cum. Time hr:mn	Comment	Inj. Temp. degC
MUDPUSH II	6.1	1000.00	00:06	00:06		20
P&A#1 Slurry	8.7	750.00	00:12	00:18		20
MUDPUSH II	0.9	1000.00	00:01	00:19		20
OBM :	23.2		00:20			
> OBM	20.0	1500.00	00:13	00:32		20
> OBM	3.2	500.00	00:06	00:38		20
Maximum Required Hydraulic Horsepower (HHP)				48.8 kW (at 00:19 hr:mn)		

Table A.18: Pumping schedule: Displacement volumes

Displacement Volume Considerations		
	Volume m3	Variation m3
Theoretical displacement volume	23.9	
Underdisplacement		0.7
Final Displacement	23.2	

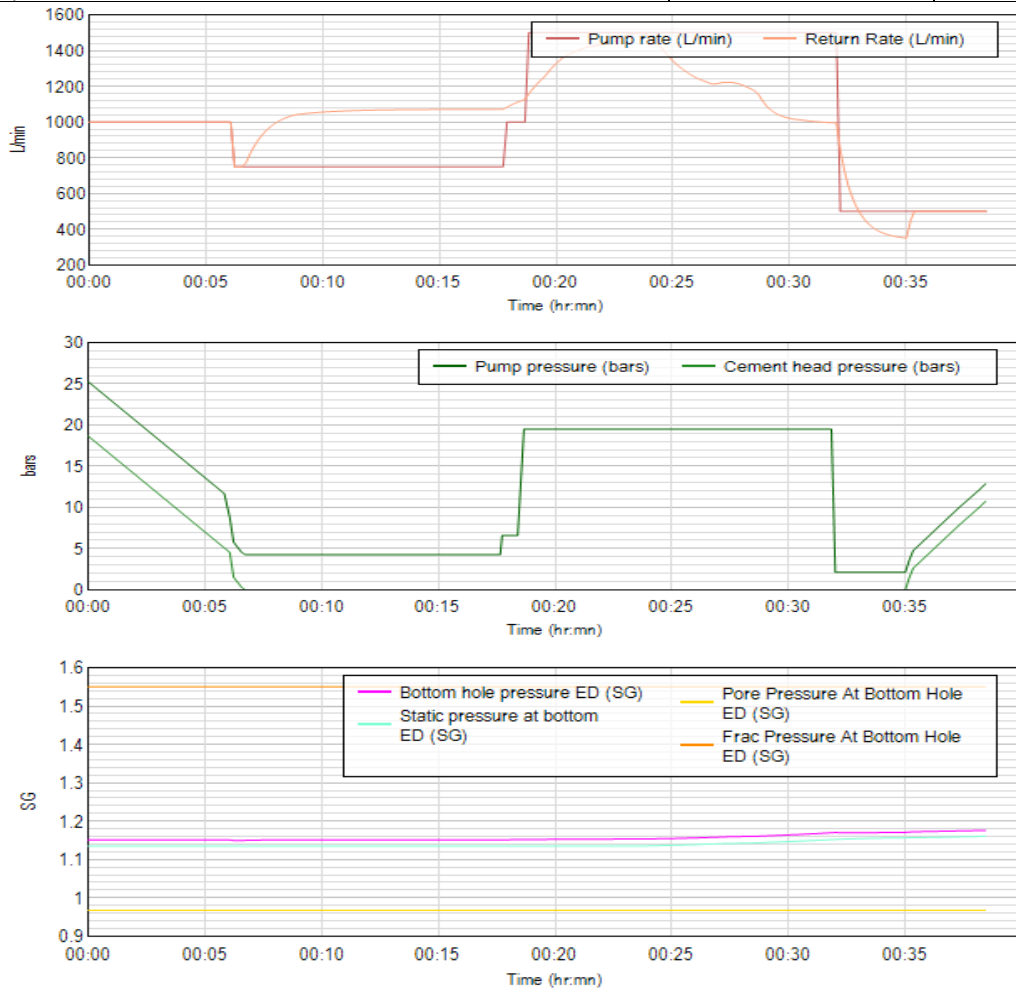

Figure A.11-13: Pumping schedule: Rates and pressures from pumping

Well Security

Table A.19: Well security

Status	Description	Min. Pressure Margin bars	at Depth m	at Time hr:mn
Success	Fracturing	98	2510.0	00:38
Success	Production/Influx	3	2475.0	00:22
Success	Burst	664	0.0	00:00
Success	Collapse	650	945.0	00:22

Well Control

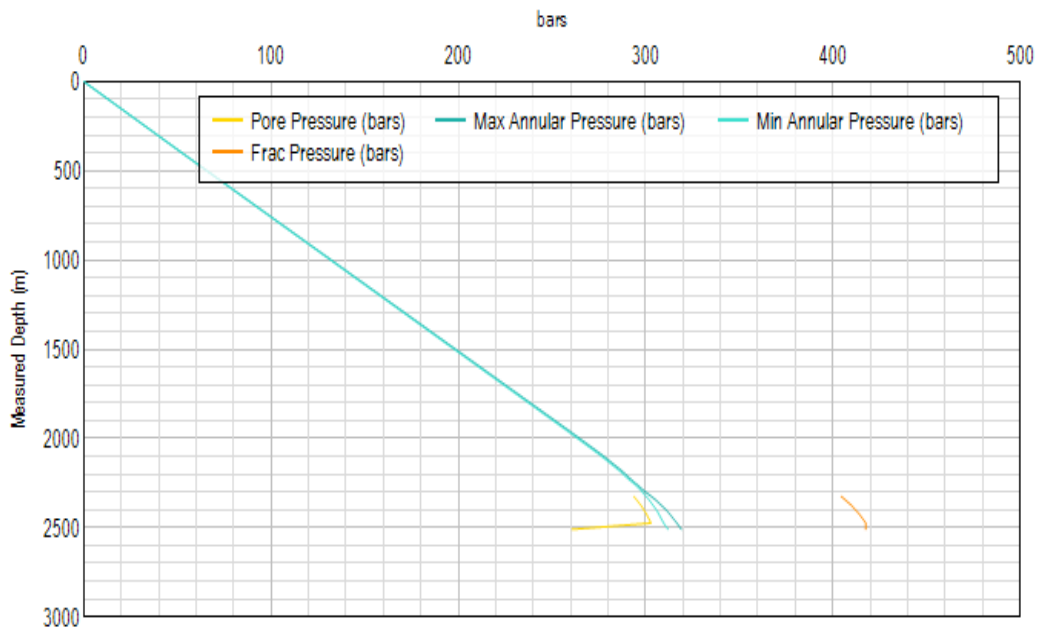

Figure A.14: Well security: Well control graph

Temperature Outputs

BHST :	89 degC	Simulated BHCT :	46 degC
Static Temp at TOC :	85 degC	Simulated HCT at TOC :	47 degC

Initial Condition

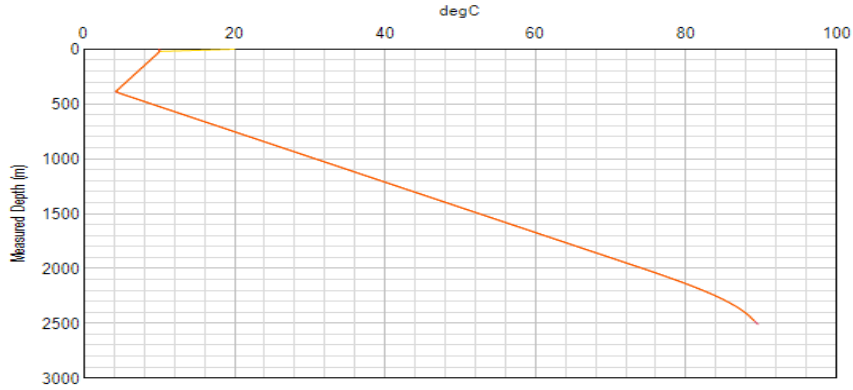

Figure A.15: Temperature outputs: Initial temperature conditions

Final Condition t = 00:38 hr:mn

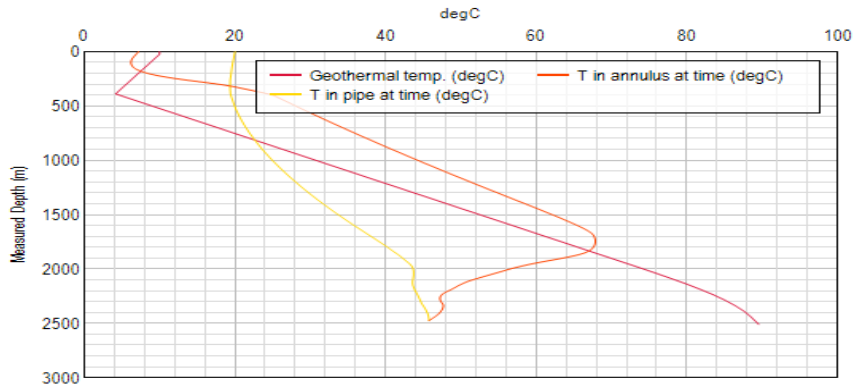

Figure A.16: Temperature outputs: Final temperature conditions

BHCT and Interface temperatures

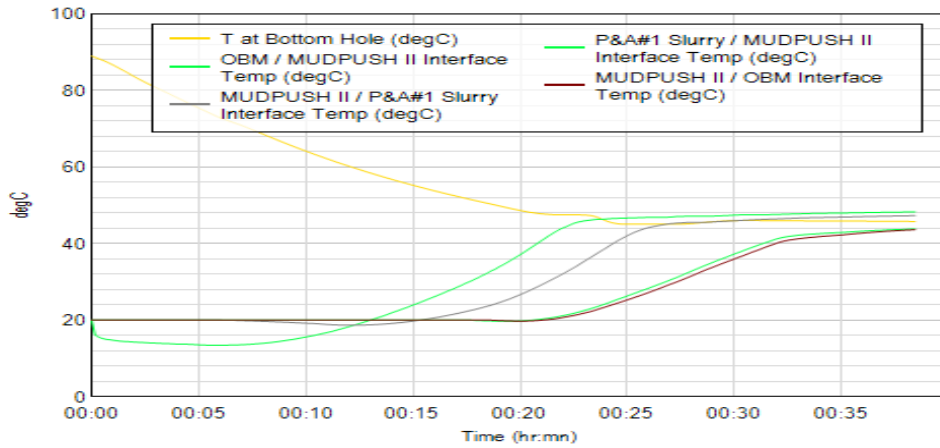

Figure A.17: Temperature outputs: Bottom hole circulation temperature and interface temperature

WELLCLEAN III

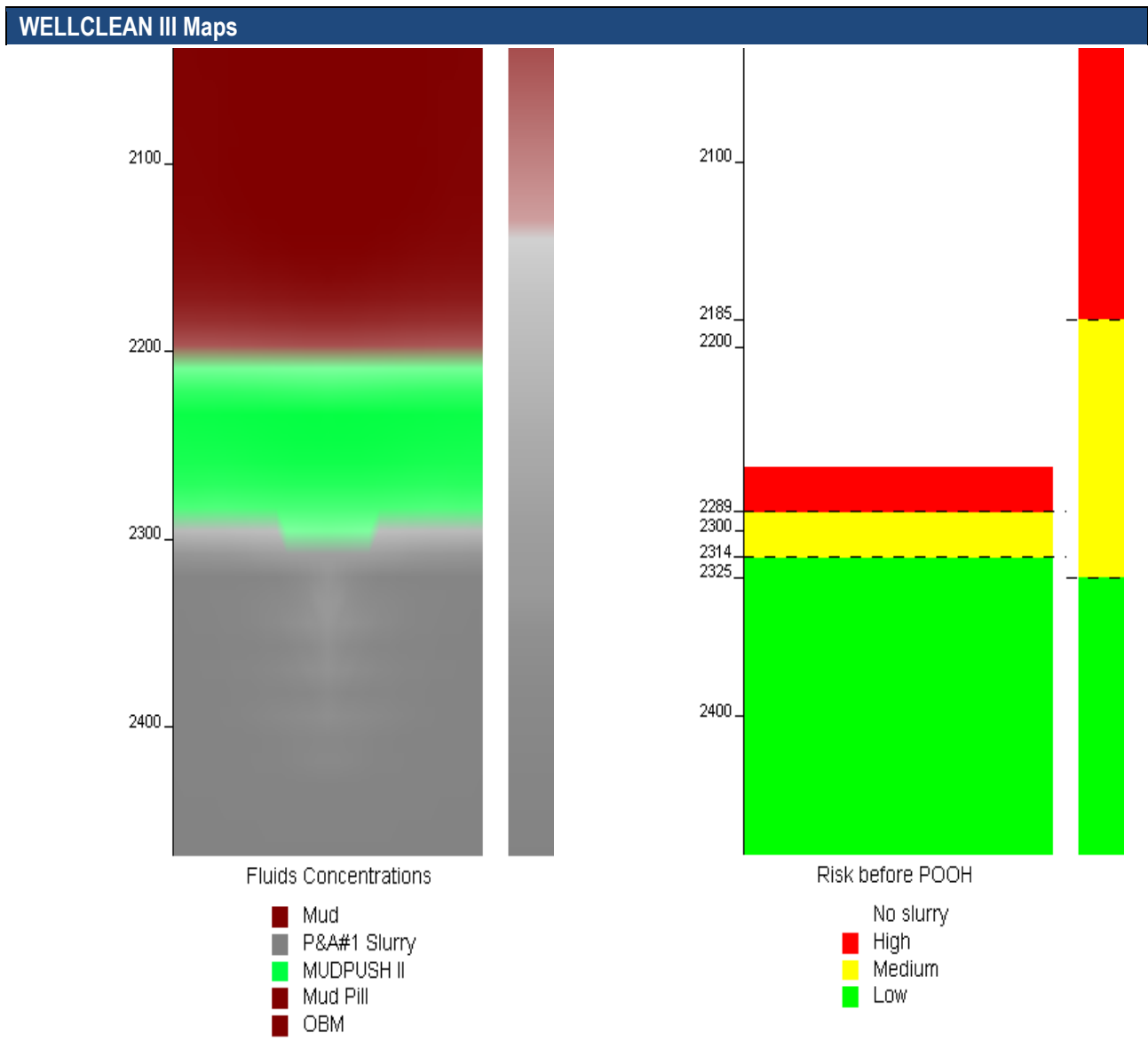

Figure A.18: Wellclean 3: Fluid concentrations and Risk before POOH

- **High risk of contamination**
- **Medium risk of contamination**
- **Low risk of contamination**

Slurry concentration is less than 50 % (by unit of volume).
There is no chance of finding hard cement when tagging within a few hours.

Slurry concentration is between 50 % and 80 % (by unit of volume).
It is possible to find some soft cement when tagging but it will be most likely not strong enough to kick off the well or even to provide a proper wellbore isolation.

Slurry concentration is between 80 % and 100 % (by unit of volume).
Cement plug should be designed in such a way the target of the top of cement should be within the 'green risk' zone. Hard cement should be found in that zone once compressive strength has developed, i.e. after the duration determined by the lab tests at downhole condition.

Fluid Concentrations before POOH

Average fluid concentration in annulus

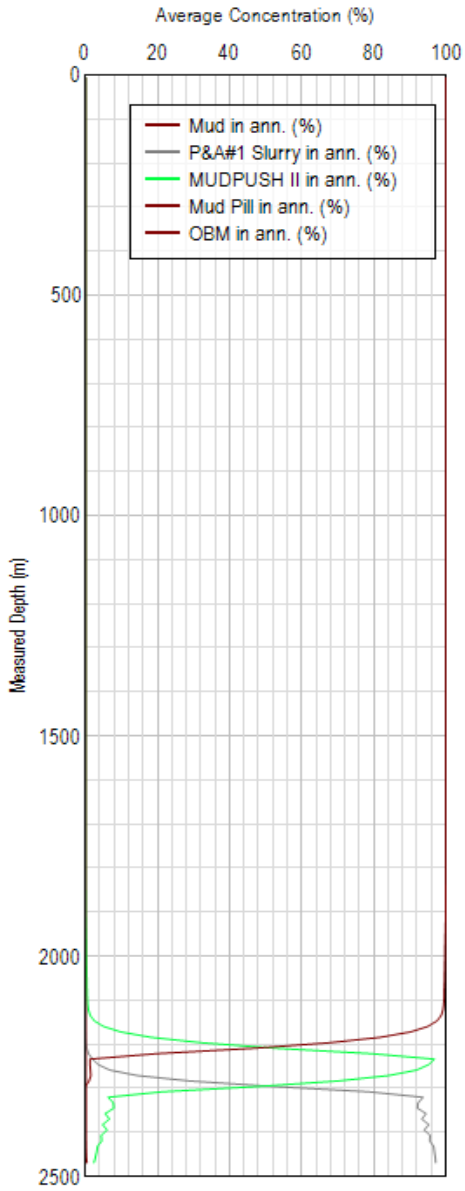

Figure A.19: Wellclean 3: Fluid concentration in annulus

Average fluid concentration in pipe

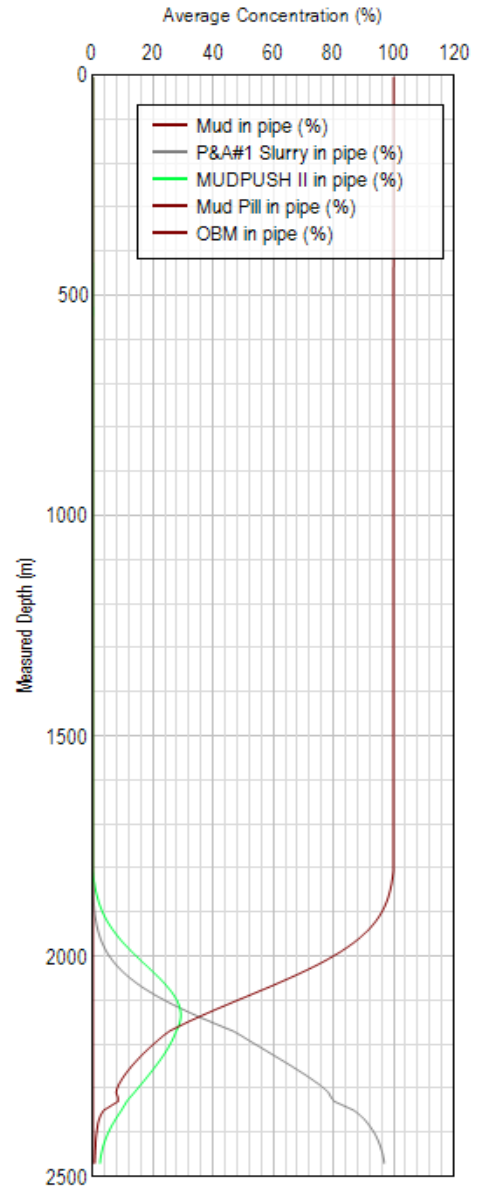

Figure A.20: Wellclean 3: Fluid concentration in pipe

FINAL CONTAMINATION RISK (AFTER POOH)

Table A.20: Final contamination risk: POOH summary

POOH Summary			
Final DP depth :	2064.0 m	Theoretical Top of Plug:	2290.0 m
Theoretical Top of Plug (based on slurry volume)			2290.0 m
Initial Top of Plug from POOH (Uncontaminated POOH Simulation)			2290.0 m
Estimated Top of Cement after POOH (Final POOH Simulation)			2308.5 m

Final Contamination Risk

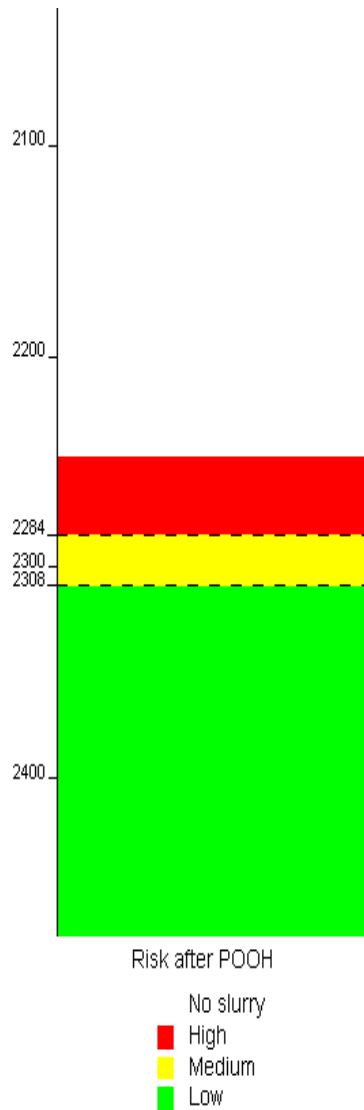

Figure A.21: Final contamination risk: Risk after POOH

Note : Simulation assumes that fluids are free to balance themselves

Operator Summary

Table A.21: Operator summary: Fluid volume summary

Fluid Volume Summary					
Fluid Name	Pumped Volume m3	Fluid Dead Volume m3	Total Fluid Volume m3	Mix Fluid Dead Volume m3	Silo Dead Weight tonne
P&A#1 Slurry	8.7	0.0	8.7	0.0	0
MUDPUSH II	7.0	0.0	7.0	0.0	0

Table A.22: Operator summary: Material summary

Material Summary							
Additive	Pumped Quantity	Required Quantity	Loadout Quantity	Loadout Items	Pack. Name	Pack. Size	Comment
P&A#1 Slurry Blend	11716 kg	11716 kg	11716 kg	0.00	bulk	0 kg	
Sea Water	5.1 m3	5.1 m3	5.1 m3	0.00		0.0 m3	
B411	0.0 m3	0.0 m3	0.0 m3	4.94	pail	0.0 m3	
D031	5460 kg	5460 kg	5460 kg	109.44	sack	50 kg	
Fresh Water	5.7 m3	5.7 m3	5.7 m3	0.00		0.0 m3	
B174	30 kg	30 kg	30 kg	66.36	bulk	0 kg	
B213	0.0 m3	0.0 m3	0.0 m3	11.10	pail	0.0 m3	

Table A.23: Operator summary: Fluid preparations

Fluid Preparations					
P&A#1 Slurry					
Pumped Volume :	8.7 m3			Yield :	0.75 m3/tonne
Slurry Density :	1.92 SG			SVF :	41.7 %
Dry Phase	Concentration	Reference	Pumped Quantity	Required Quantity	Loadout Quantity
Total Dry Phase			11716 kg	11716 kg	
P&A#1 Slurry Blend:	43 kg	per sack	11716 kg	11716 kg	11716 kg
- Norwell G	1000 kg/tonne	WBWOB	11716 kg	11716 kg	11716 kg
Liquid Phase	Concentration	Reference	Pumped Quantity	Required Quantity	Loadout Quantity
Total Mix Fluid	435.29 L/tonne	VBWOB	5.1 m3	5.1 m3	
Sea Water	434.29 L/tonne	VBWOB	5.1 m3	5.1 m3	5.1 m3
B411	1.00 L/tonne	VBWOC	0.0 m3	0.0 m3	0.0 m3

Lab report : XYZ 00000-01

Appendix B

This appendix contains all the final POOH results from all the different cases simulated. The figures and tables are marked with DLS, inclination angle, stinger size and length. The dimensions on the graphs might not match each other as the simulation gives out different proportions on graphs for different cases. However, the numbers and values in tables and figures are comparable. All the tables and figures are taken from reports generated in the software “Cementics zonal isolation”.

FINAL CONTAMINATION RISK (AFTER POOH) DLS: 1.8 degree / 30 meters Angle into res: 60 degrees

Table B.1: POOH results case 1-3

1. POOH Summary - Stinger size ID: 3.3inch - Stinger length: 150 meters			
Final DP depth :	2230.1 m	Theoretical Top of Plug:	2440.0 m
Theoretical Top of Plug (based on slurry volume)			2440.0 m
Initial Top of Plug from POOH (Uncontaminated POOH Simulation)			2440.3 m
Estimated Top of Cement after POOH (Final POOH Simulation)			2458.3 m
2. POOH Summary - Stinger size ID: 3.8inch - Stinger length: 150 meters			
Final DP depth :	2248.1 m	Theoretical Top of Plug:	2440.0 m
Theoretical Top of Plug (based on slurry volume)			2440.0 m
Initial Top of Plug from POOH (Uncontaminated POOH Simulation)			2440.0 m
Estimated Top of Cement after POOH (Final POOH Simulation)			2452.3 m
3. POOH Summary - Stinger size ID: 3.3inch - Stinger length: 300 meters			
Final DP depth :	2173.1 m	Theoretical Top of Plug:	2440.0 m
Theoretical Top of Plug (based on slurry volume)			2440.0 m
Initial Top of Plug from POOH (Uncontaminated POOH Simulation)			2440.0 m
Estimated Top of Cement after POOH (Final POOH Simulation)			2456.9 m

Final Contamination Risk (from left to right: 1,2,3)

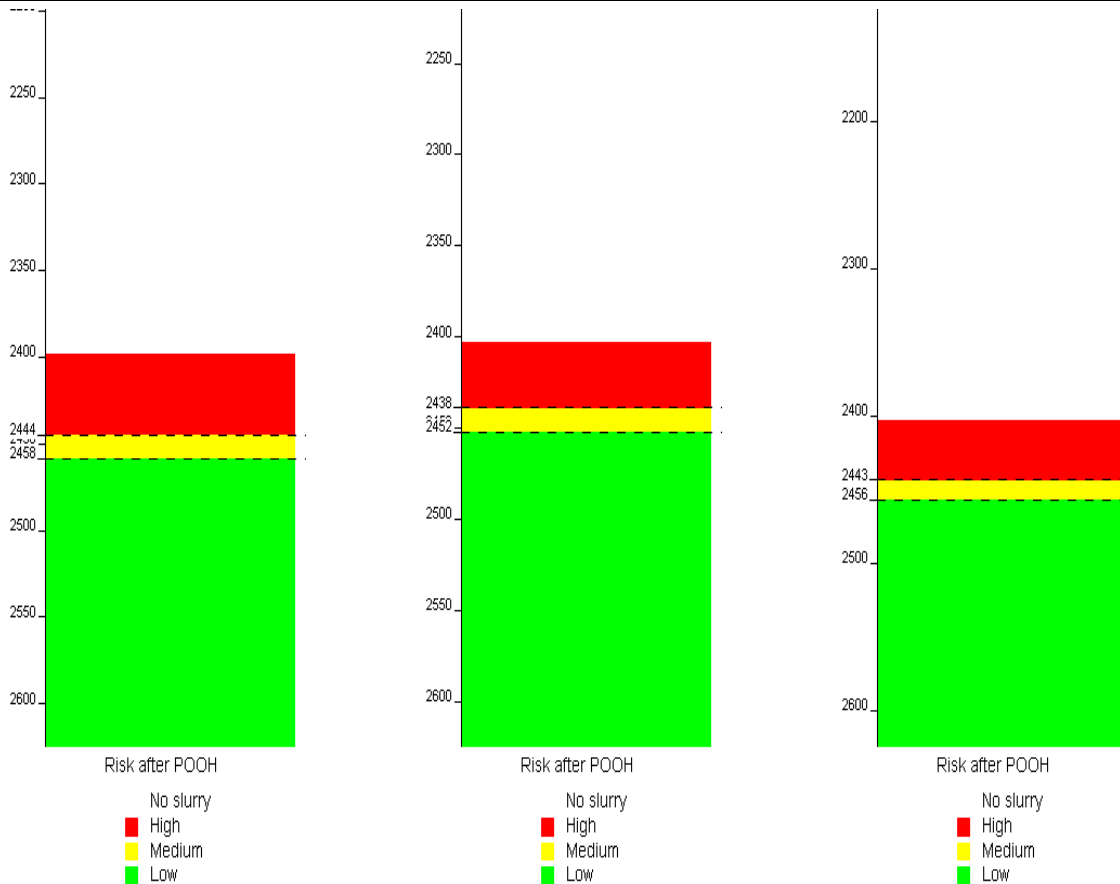

Figure B.1: POOH results case 1-3

Note : Simulation assumes that fluids are free to balance themselves

FINAL CONTAMINATION RISK (AFTER POOH) DLS: 1.8 degree / 30 meters Angle into res: 60 degrees

Table B.2: POOH results case 4-6

4. POOH Summary - Stinger size ID: 3.8inch - Stinger length: 300 meters			
Final DP depth :	2208.0 m	Theoretical Top of Plug:	2440.0 m
Theoretical Top of Plug (based on slurry volume)			2440.0 m
Initial Top of Plug from POOH (Uncontaminated POOH Simulation)			2440.0 m
Estimated Top of Cement after POOH (Final POOH Simulation)			2483.5 m
5. POOH Summary - Stinger size ID: 3.3inch - Stinger length: 450 meters			
Final DP depth :	2107.7 m	Theoretical Top of Plug:	2440.0 m
Theoretical Top of Plug (based on slurry volume)			2440.0 m
Initial Top of Plug from POOH (Uncontaminated POOH Simulation)			2440.0 m
Estimated Top of Cement after POOH (Final POOH Simulation)			2456.6 m
6. POOH Summary - Stinger size ID: 3.8inch - Stinger length: 450 meters			
Final DP depth :	2184.3 m	Theoretical Top of Plug:	2440.0 m
Theoretical Top of Plug (based on slurry volume)			2440.0 m
Initial Top of Plug from POOH (Uncontaminated POOH Simulation)			2440.0 m
Estimated Top of Cement after POOH (Final POOH Simulation)			2483.6 m

Final Contamination Risk (from left to right: 4,5,6)

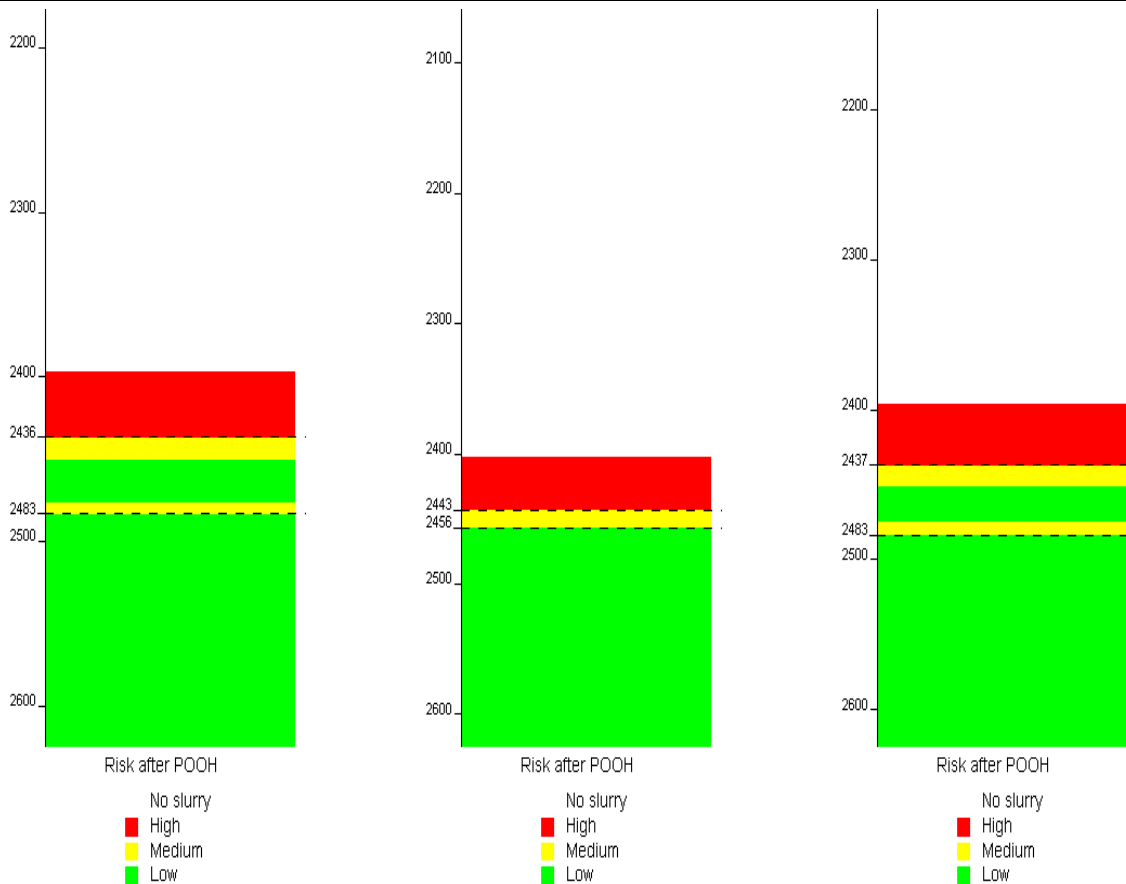

Figure B.2: POOH results case 4-6

Note : Simulation assumes that fluids are free to balance themselves

FINAL CONTAMINATION RISK (AFTER POOH) DLS: 1.8 degree / 30 meters Angle into res: 70 degrees

Table B.3: POOH results case 7-9

7. POOH Summary - Stinger size ID: 3.3inch - Stinger length: 150 meters			
Final DP depth :	2293.5 m	Theoretical Top of Plug:	2505.0 m
Theoretical Top of Plug (based on slurry volume)			2505.0 m
Initial Top of Plug from POOH (Uncontaminated POOH Simulation)			2505.3 m
Estimated Top of Cement after POOH (Final POOH Simulation)			2520.3 m
8. POOH Summary - Stinger size ID: 3.8inch - Stinger length: 150 meters			
Final DP depth :	2312.1 m	Theoretical Top of Plug:	2505.0 m
Theoretical Top of Plug (based on slurry volume)			2505.0 m
Initial Top of Plug from POOH (Uncontaminated POOH Simulation)			2505.0 m
Estimated Top of Cement after POOH (Final POOH Simulation)			2547.0 m
9. POOH Summary - Stinger size ID: 3.3inch - Stinger length: 300 meters			
Final DP depth :	2235.3 m	Theoretical Top of Plug:	2505.0 m
Theoretical Top of Plug (based on slurry volume)			2505.0 m
Initial Top of Plug from POOH (Uncontaminated POOH Simulation)			2505.0 m
Estimated Top of Cement after POOH (Final POOH Simulation)			2518.9 m

Final Contamination Risk (from left to right: 7,8,9)

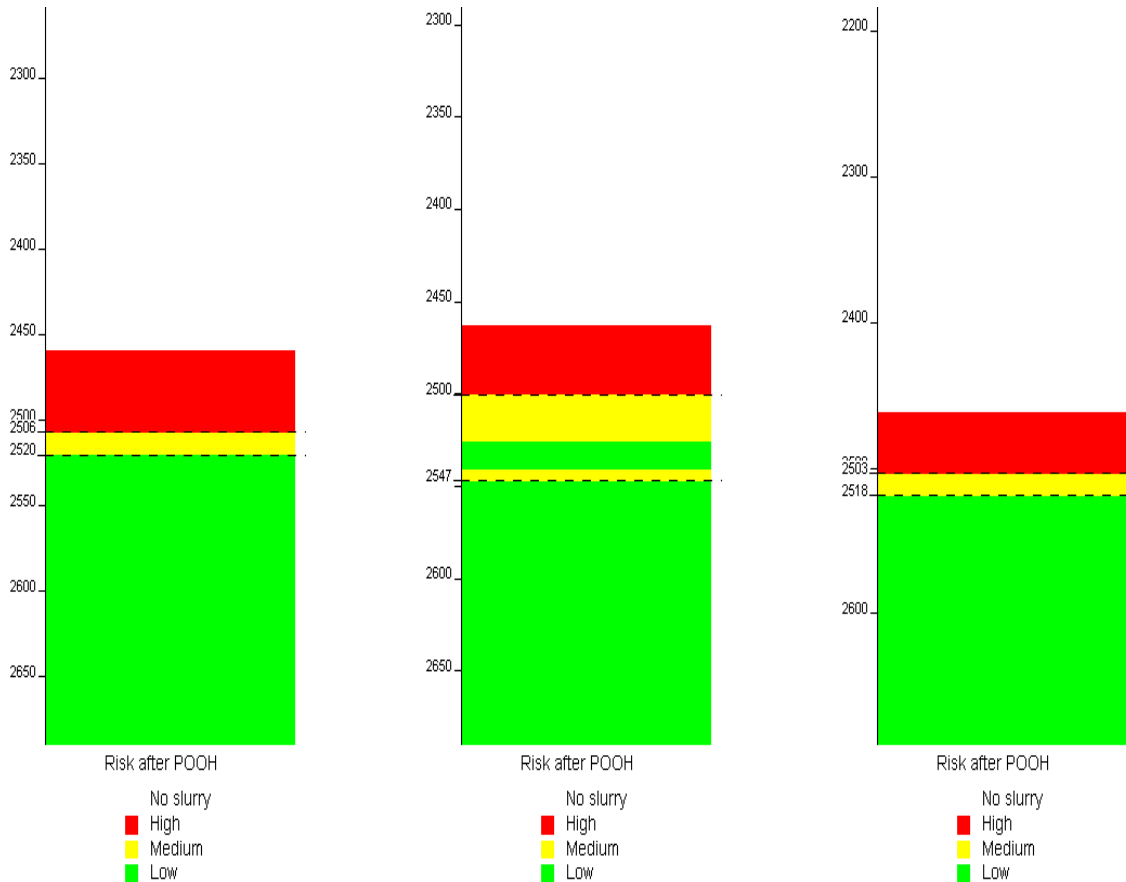

Figure B.3: POOH results case 7-9

Note : Simulation assumes that fluids are free to balance themselves

FINAL CONTAMINATION RISK (AFTER POOH) DLS: 1.8 degree / 30 meters Angle into res: 70 degrees

Table B.4: POOH results case 10-12

10. POOH Summary - Stinger size ID: 3.8inch - Stinger length: 300 meters			
Final DP depth :	2271.4 m	Theoretical Top of Plug:	2505.0 m
Theoretical Top of Plug (based on slurry volume)			2505.0 m
Initial Top of Plug from POOH (Uncontaminated POOH Simulation)			2505.0 m
Estimated Top of Cement after POOH (Final POOH Simulation)			2545.9 m
11. POOH Summary - Stinger size ID: 3.3inch - Stinger length: 450 meters			
Final DP depth :	2169.7 m	Theoretical Top of Plug:	2505.0 m
Theoretical Top of Plug (based on slurry volume)			2505.0 m
Initial Top of Plug from POOH (Uncontaminated POOH Simulation)			2505.0 m
Estimated Top of Cement after POOH (Final POOH Simulation)			2545.6 m
12. POOH Summary - Stinger size ID: 3.8inch - Stinger length: 450 meters			
Final DP depth :	2246.7 m	Theoretical Top of Plug:	2505.0 m
Theoretical Top of Plug (based on slurry volume)			2505.0 m
Initial Top of Plug from POOH (Uncontaminated POOH Simulation)			2505.0 m
Estimated Top of Cement after POOH (Final POOH Simulation)			2544.2 m

Final Contamination Risk (from left to right: 10,11,12)

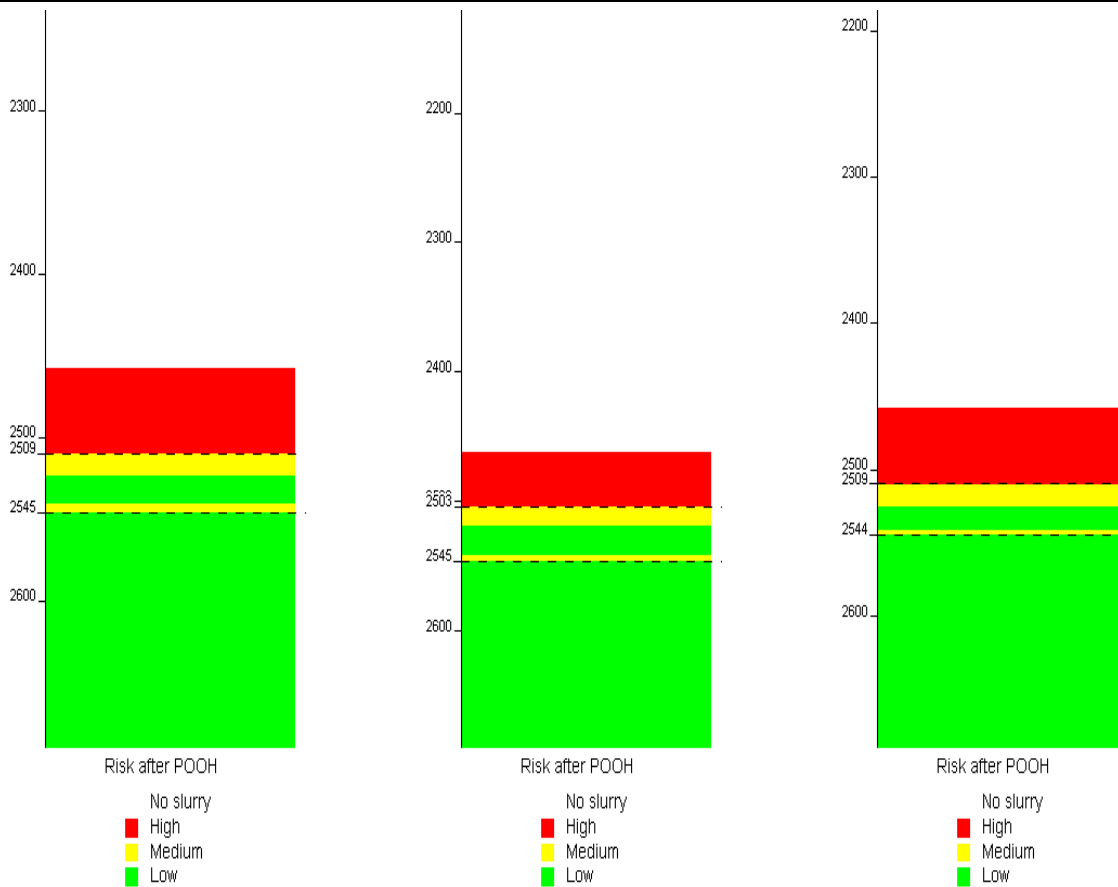

Figure B.4: POOH results case 10-12 Note : Simulation assumes that fluids are free to balance themselves

FINAL CONTAMINATION RISK (AFTER POOH) DLS: 1.8 degree / 30 meters Angle into res: 80 degrees

Table B.5: POOH results case 13-15

13. POOH Summary - Stinger size ID: 3.3inch - Stinger length: 150 meters			
Final DP depth :	2337.5 m	Theoretical Top of Plug:	2550.0 m
Theoretical Top of Plug (based on slurry volume)		2550.0 m	
Initial Top of Plug from POOH (Uncontaminated POOH Simulation)		2550.0 m	
Estimated Top of Cement after POOH (Final POOH Simulation)		2593.5 m	
14. POOH Summary - Stinger size ID: 3.8inch - Stinger length: 150 meters			
Final DP depth :	2356.5 m	Theoretical Top of Plug:	2550.0 m
Theoretical Top of Plug (based on slurry volume)		2550.0 m	
Initial Top of Plug from POOH (Uncontaminated POOH Simulation)		2550.0 m	
Estimated Top of Cement after POOH (Final POOH Simulation)		2568.3 m	
15. POOH Summary - Stinger size ID: 3.3inch - Stinger length: 300 meters			
Final DP depth :	2278.4 m	Theoretical Top of Plug:	2550.0 m
Theoretical Top of Plug (based on slurry volume)		2550.0 m	
Initial Top of Plug from POOH (Uncontaminated POOH Simulation)		2550.3 m	
Estimated Top of Cement after POOH (Final POOH Simulation)		2590.8 m	

Final Contamination Risk (from left to right: 13,14,15)

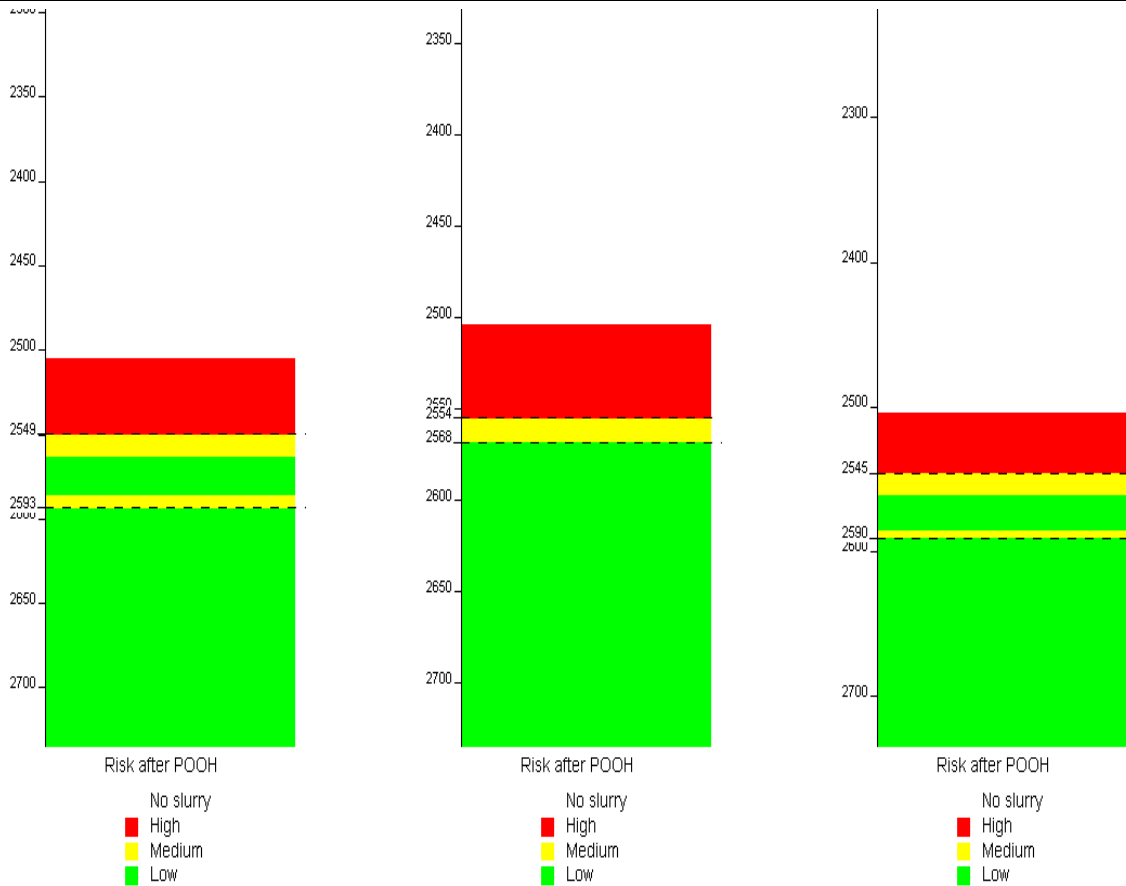

Figure B.5: POOH results case 13-15 Note : Simulation assumes that fluids are free to balance themselves

FINAL CONTAMINATION RISK (AFTER POOH) DLS: 1.8 degree / 30 meters Angle into res: 80 degrees

Table B.6: POOH results case 16-18

16. POOH Summary - Stinger size ID: 3.8inch - Stinger length: 300 meters			
Final DP depth :	2315.2 m	Theoretical Top of Plug:	2550.0 m
Theoretical Top of Plug (based on slurry volume)		2550.0 m	
Initial Top of Plug from POOH (Uncontaminated POOH Simulation)		2550.0 m	
Estimated Top of Cement after POOH (Final POOH Simulation)		2566.5 m	
17. POOH Summary - Stinger size ID: 3.3inch - Stinger length: 450 meters			
Final DP depth :	2212.6 m	Theoretical Top of Plug:	2550.0 m
Theoretical Top of Plug (based on slurry volume)		2550.0 m	
Initial Top of Plug from POOH (Uncontaminated POOH Simulation)		2550.0 m	
Estimated Top of Cement after POOH (Final POOH Simulation)		2590.9 m	
18. POOH Summary - Stinger size ID: 3.8inch - Stinger length: 450 meters			
Final DP depth :	2289.9 m	Theoretical Top of Plug:	2550.0 m
Theoretical Top of Plug (based on slurry volume)		2550.0 m	
Initial Top of Plug from POOH (Uncontaminated POOH Simulation)		2550.0 m	
Estimated Top of Cement after POOH (Final POOH Simulation)		2566.6 m	

Final Contamination Risk (from left to right: 16,17,18)

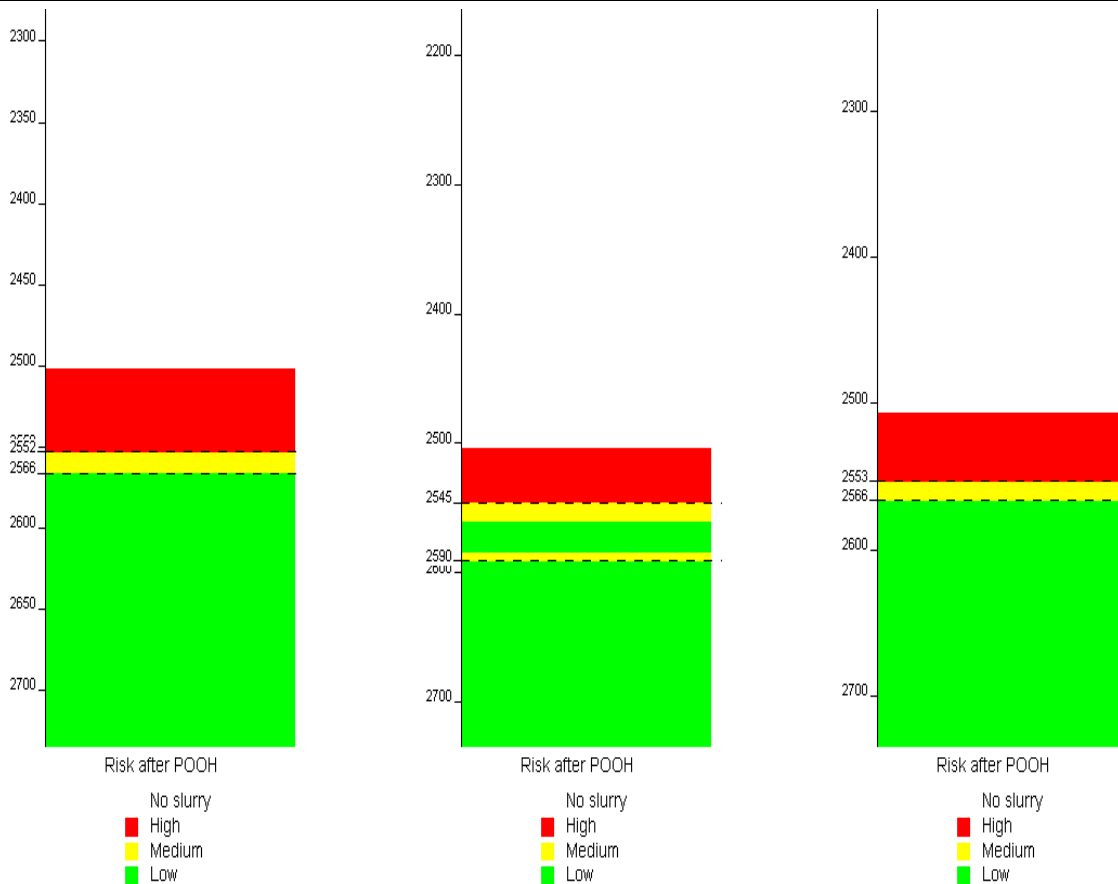

Figure B.6: POOH results case 16-18 Note : Simulation assumes that fluids are free to balance themselves

FINAL CONTAMINATION RISK (AFTER POOH) DLS: 1.8 degree / 30 meters Angle into res: 90 degrees

Table B.7: POOH results case 19-21

19. POOH Summary - Stinger size ID: 3.3inch - Stinger length: 150 meters			
Final DP depth :	2337.5 m	Theoretical Top of Plug:	2550.0 m
Theoretical Top of Plug (based on slurry volume)			2550.0 m
Initial Top of Plug from POOH (Uncontaminated POOH Simulation)			2550.0 m
Estimated Top of Cement after POOH (Final POOH Simulation)			2593.5 m
20. POOH Summary - Stinger size ID: 3.8inch - Stinger length: 150 meters			
Final DP depth :	2356.5 m	Theoretical Top of Plug:	2550.0 m
Theoretical Top of Plug (based on slurry volume)			2550.0 m
Initial Top of Plug from POOH (Uncontaminated POOH Simulation)			2550.0 m
Estimated Top of Cement after POOH (Final POOH Simulation)			2568.3 m
21. POOH Summary - Stinger size ID: 3.3inch - Stinger length: 300 meters			
Final DP depth :	2278.4 m	Theoretical Top of Plug:	2550.0 m
Theoretical Top of Plug (based on slurry volume)			2550.0 m
Initial Top of Plug from POOH (Uncontaminated POOH Simulation)			2550.3 m
Estimated Top of Cement after POOH (Final POOH Simulation)			2590.8 m

Final Contamination Risk (from left to right: 19,20,21)

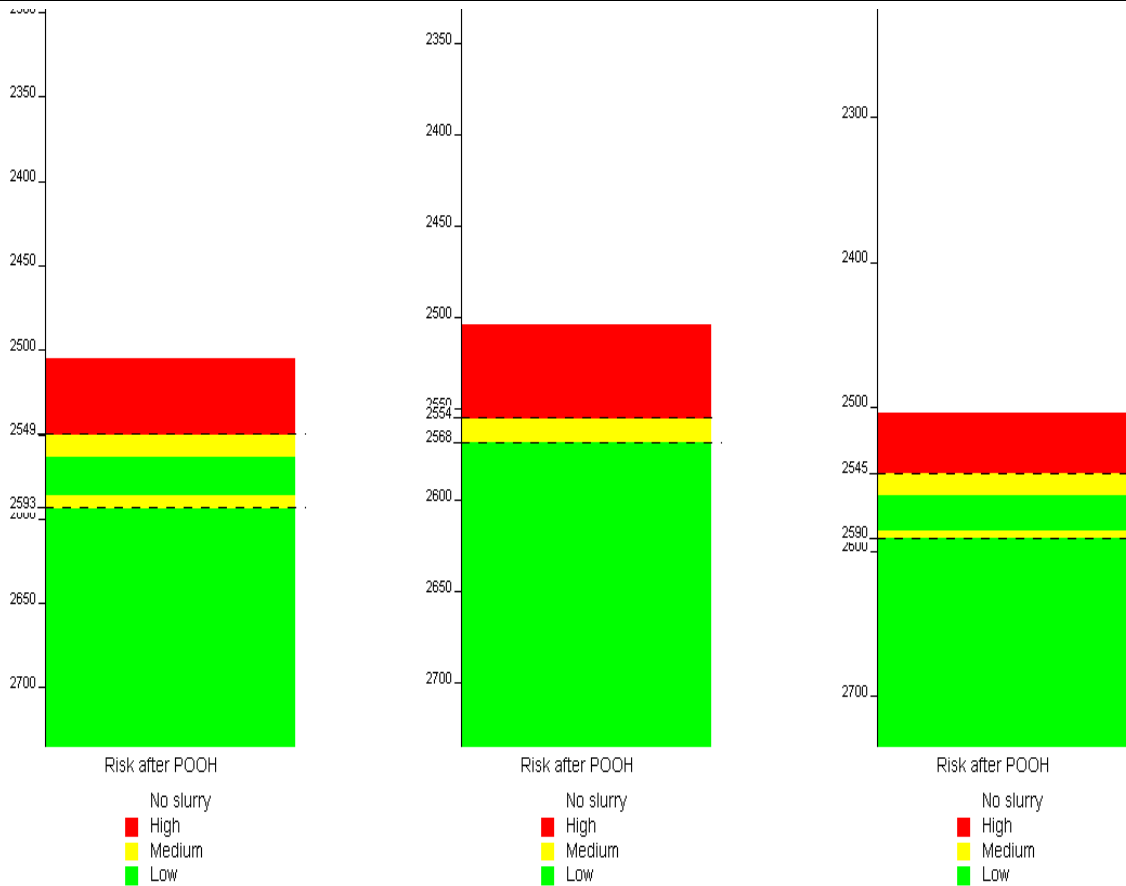

Figure B.7: POOH results case 19-21 Note : Simulation assumes that fluids are free to balance themselves

FINAL CONTAMINATION RISK (AFTER POOH) DLS: 1.8 degree / 30 meters Angle into res: 90 degrees

Table B.8: POOH results case 22-24

22. POOH Summary - Stinger size ID: 3.8inch - Stinger length: 300 meters			
Final DP depth :	2315.2 m	Theoretical Top of Plug:	2550.0 m
Theoretical Top of Plug (based on slurry volume)		2550.0 m	
Initial Top of Plug from POOH (Uncontaminated POOH Simulation)		2550.0 m	
Estimated Top of Cement after POOH (Final POOH Simulation)		2566.5 m	
23. POOH Summary - Stinger size ID: 3.3inch - Stinger length: 450 meters			
Final DP depth :	2212.6 m	Theoretical Top of Plug:	2550.0 m
Theoretical Top of Plug (based on slurry volume)		2550.0 m	
Initial Top of Plug from POOH (Uncontaminated POOH Simulation)		2550.0 m	
Estimated Top of Cement after POOH (Final POOH Simulation)		2590.9 m	
24. POOH Summary - Stinger size ID: 3.8inch - Stinger length: 450 meters			
Final DP depth :	2289.9 m	Theoretical Top of Plug:	2550.0 m
Theoretical Top of Plug (based on slurry volume)		2550.0 m	
Initial Top of Plug from POOH (Uncontaminated POOH Simulation)		2550.0 m	
Estimated Top of Cement after POOH (Final POOH Simulation)		2566.6 m	

Final Contamination Risk (from left to right: 22,23,24)

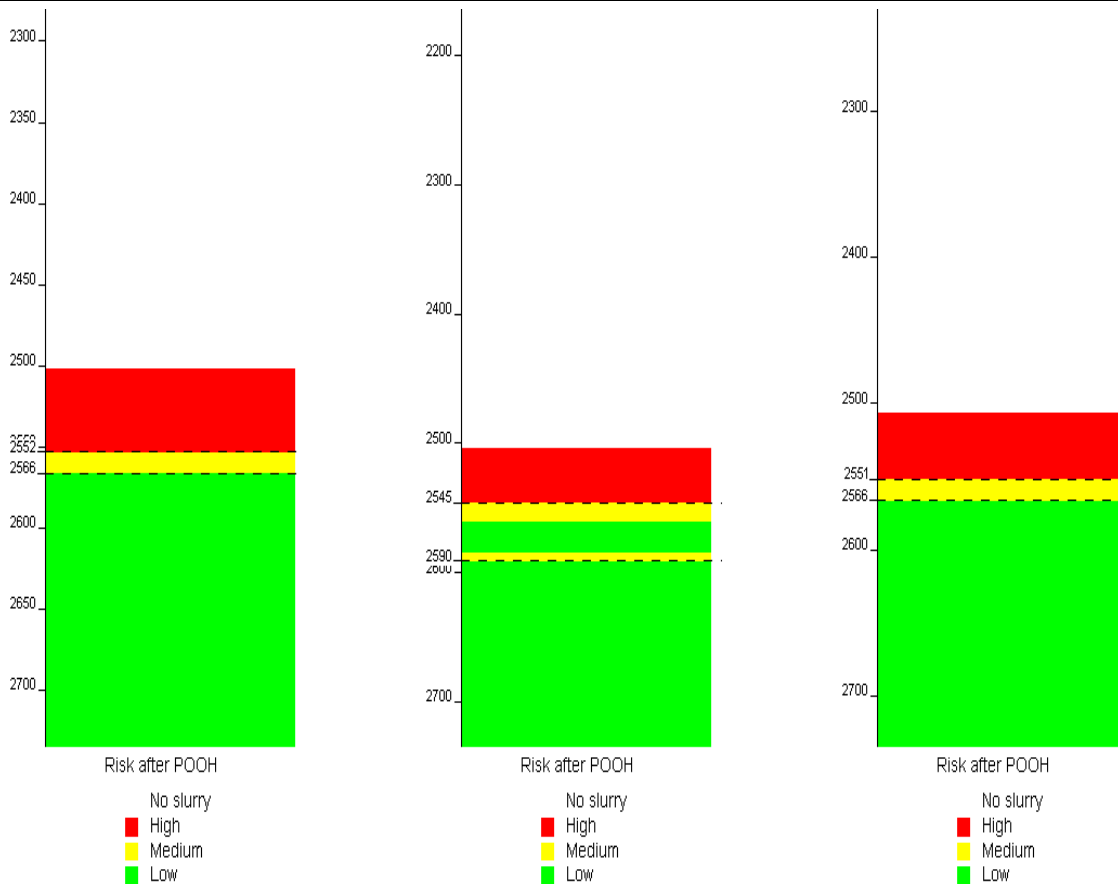

Figure B.8: POOH results case 22-24 Note : Simulation assumes that fluids are free to balance themselves

FINAL CONTAMINATION RISK (AFTER POOH) DLS: 3.0 degree / 30 meters Angle into res: 60 degrees

Table B.9: POOH results case 25-27

25. POOH Summary - Stinger size ID: 3.3inch - Stinger length: 150 meters			
Final DP depth :	2118.2 m	Theoretical Top of Plug:	2325.0 m
Theoretical Top of Plug (based on slurry volume)			2325.0 m
Initial Top of Plug from POOH (Uncontaminated POOH Simulation)			2325.4 m
Estimated Top of Cement after POOH (Final POOH Simulation)			2338.9 m
26. POOH Summary - Stinger size ID: 3.8inch - Stinger length: 150 meters			
Final DP depth :	2134.9 m	Theoretical Top of Plug:	2325.0 m
Theoretical Top of Plug (based on slurry volume)			2325.0 m
Initial Top of Plug from POOH (Uncontaminated POOH Simulation)			2325.0 m
Estimated Top of Cement after POOH (Final POOH Simulation)			2343.5 m
27. POOH Summary - Stinger size ID: 3.3inch - Stinger length: 300 meters			
Final DP depth :	2064.6 m	Theoretical Top of Plug:	2325.0 m
Theoretical Top of Plug (based on slurry volume)			2325.0 m
Initial Top of Plug from POOH (Uncontaminated POOH Simulation)			2325.0 m
Estimated Top of Cement after POOH (Final POOH Simulation)			2335.4 m

Final Contamination Risk (from left to right: 25,26,27)

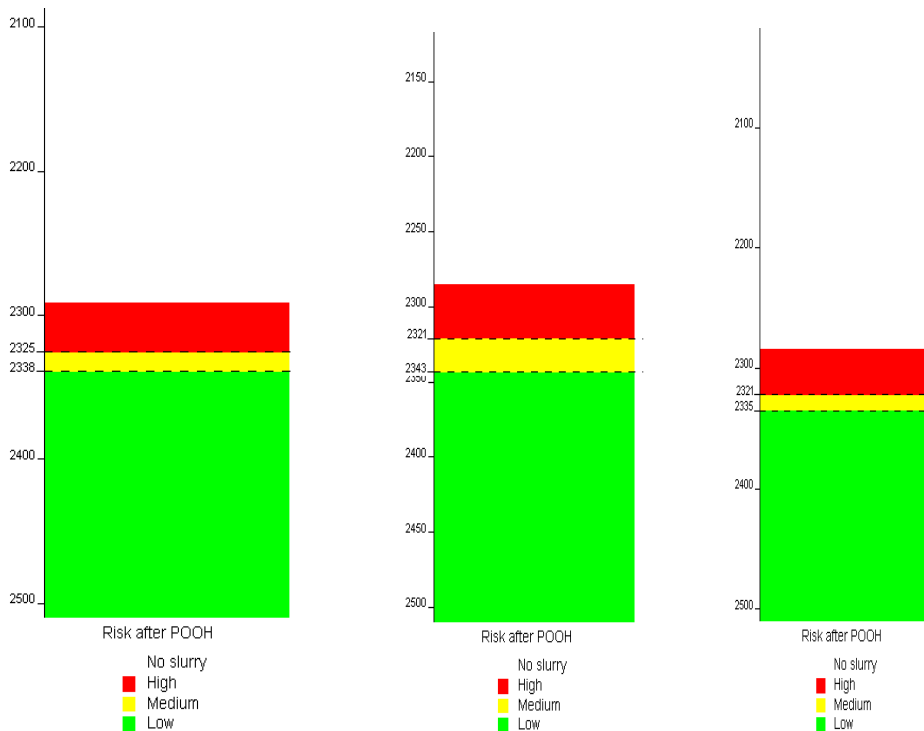

Figure B.9: POOH results case 25-27 Note : Simulation assumes that fluids are free to balance themselves

FINAL CONTAMINATION RISK (AFTER POOH) DLS: 3.0 degree / 30 meters Angle into res: 60 degrees

Table B.10: POOH results case 28-30

28. POOH Summary - Stinger size ID: 3.8inch - Stinger length: 300 meters			
Final DP depth :	2096.6 m	Theoretical Top of Plug:	2325.0 m
Theoretical Top of Plug (based on slurry volume)		2325.0 m	
Initial Top of Plug from POOH (Uncontaminated POOH Simulation)		2325.0 m	
Estimated Top of Cement after POOH (Final POOH Simulation)		2341.6 m	
29. POOH Summary - Stinger size ID: 3.3inch - Stinger length: 450 meters			
Final DP depth :	2000.9 m	Theoretical Top of Plug:	2325.0 m
Theoretical Top of Plug (based on slurry volume)		2325.0 m	
Initial Top of Plug from POOH (Uncontaminated POOH Simulation)		2325.0 m	
Estimated Top of Cement after POOH (Final POOH Simulation)		2335.8 m	
30. POOH Summary - Stinger size ID: 3.8inch - Stinger length: 450 meters			
Final DP depth :	2075.1 m	Theoretical Top of Plug:	2325.0 m
Theoretical Top of Plug (based on slurry volume)		2325.0 m	
Initial Top of Plug from POOH (Uncontaminated POOH Simulation)		2325.0 m	
Estimated Top of Cement after POOH (Final POOH Simulation)		2341.4 m	

Final Contamination Risk (from left to right: 28,29,30)

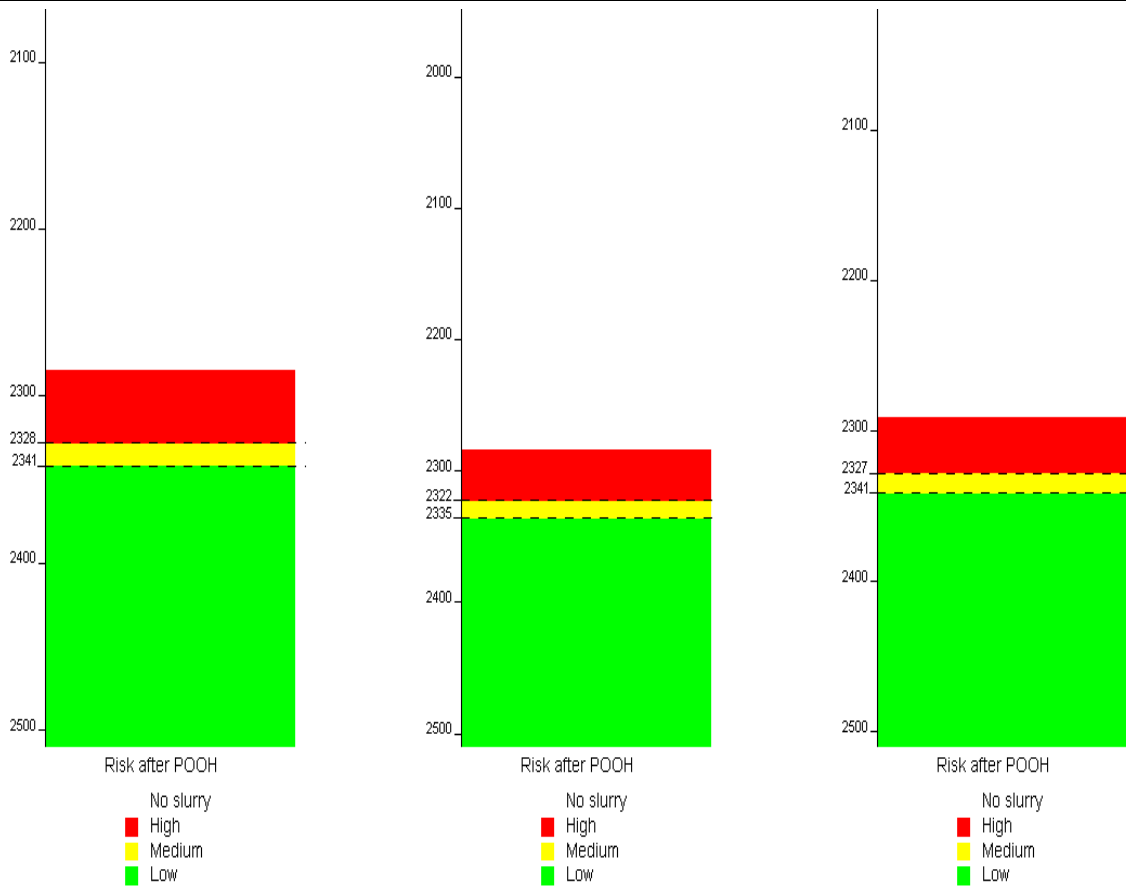

Figure B.10: POOH results case 28-30 Note : Simulation assumes that fluids are free to balance themselves

FINAL CONTAMINATION RISK (AFTER POOH) DLS: 3.0 degree / 30 meters Angle into res: 70 degrees

Table B.11: POOH results case 31-33

31. POOH Summary - Stinger size ID: 3.3inch - Stinger length: 150 meters			
Final DP depth :	2033.3 m	Theoretical Top of Plug:	2360.0 m
Theoretical Top of Plug (based on slurry volume)		2360.0 m	
Initial Top of Plug from POOH (Uncontaminated POOH Simulation)		2360.0 m	
Estimated Top of Cement after POOH (Final POOH Simulation)		2367.9 m	
32. POOH Summary - Stinger size ID: 3.8inch - Stinger length: 150 meters			
Final DP depth :	2169.3 m	Theoretical Top of Plug:	2360.0 m
Theoretical Top of Plug (based on slurry volume)		2360.0 m	
Initial Top of Plug from POOH (Uncontaminated POOH Simulation)		2360.0 m	
Estimated Top of Cement after POOH (Final POOH Simulation)		2376.7 m	
33. POOH Summary - Stinger size ID: 3.3inch - Stinger length: 300 meters			
Final DP depth :	2097.8 m	Theoretical Top of Plug:	2360.0 m
Theoretical Top of Plug (based on slurry volume)		2360.0 m	
Initial Top of Plug from POOH (Uncontaminated POOH Simulation)		2360.0 m	
Estimated Top of Cement after POOH (Final POOH Simulation)		2369.4 m	

Final Contamination Risk (from left to right: 31,32,33)

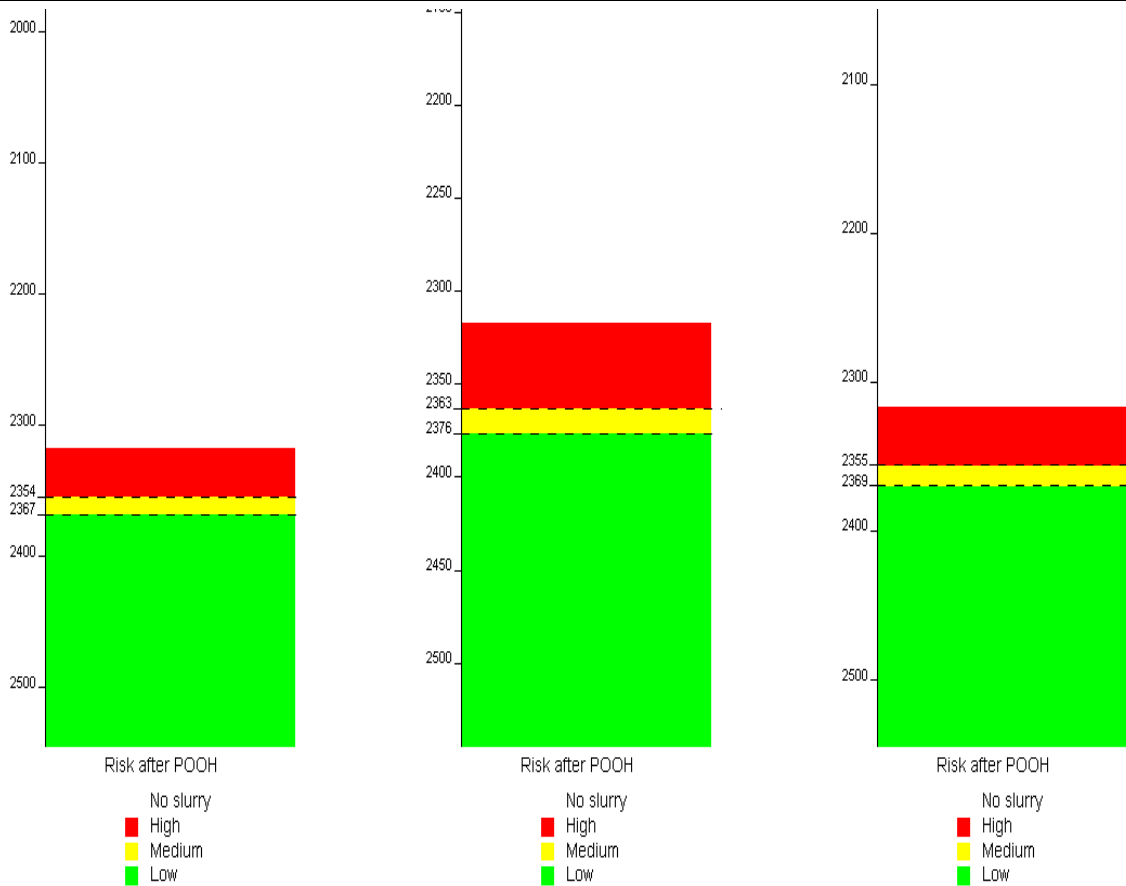

Figure B.11: POOH results case 31-33 Note : Simulation assumes that fluids are free to balance themselves

FINAL CONTAMINATION RISK (AFTER POOH) DLS: 3.0 degree / 30 meters Angle into res: 70 degrees

Table B.12: POOH results case 34-36

34. POOH Summary - Stinger size ID: 3.8inch - Stinger length: 300 meters			
Final DP depth :	2130.6 m	Theoretical Top of Plug:	2360.0 m
Theoretical Top of Plug (based on slurry volume)		2360.0 m	
Initial Top of Plug from POOH (Uncontaminated POOH Simulation)		2360.0 m	
Estimated Top of Cement after POOH (Final POOH Simulation)		2375.3 m	
35. POOH Summary - Stinger size ID: 3.3inch - Stinger length: 450 meters			
Final DP depth :	2033.3 m	Theoretical Top of Plug:	2360.0 m
Theoretical Top of Plug (based on slurry volume)		2360.0 m	
Initial Top of Plug from POOH (Uncontaminated POOH Simulation)		2360.0 m	
Estimated Top of Cement after POOH (Final POOH Simulation)		2367.9 m	
36. POOH Summary - Stinger size ID: 3.8inch - Stinger length: 450 meters			
Final DP depth :	2108.5 m	Theoretical Top of Plug:	2360.0 m
Theoretical Top of Plug (based on slurry volume)		2360.0 m	
Initial Top of Plug from POOH (Uncontaminated POOH Simulation)		2360.0 m	
Estimated Top of Cement after POOH (Final POOH Simulation)		2375.5 m	

Final Contamination Risk (from left to right: 34,35,36)

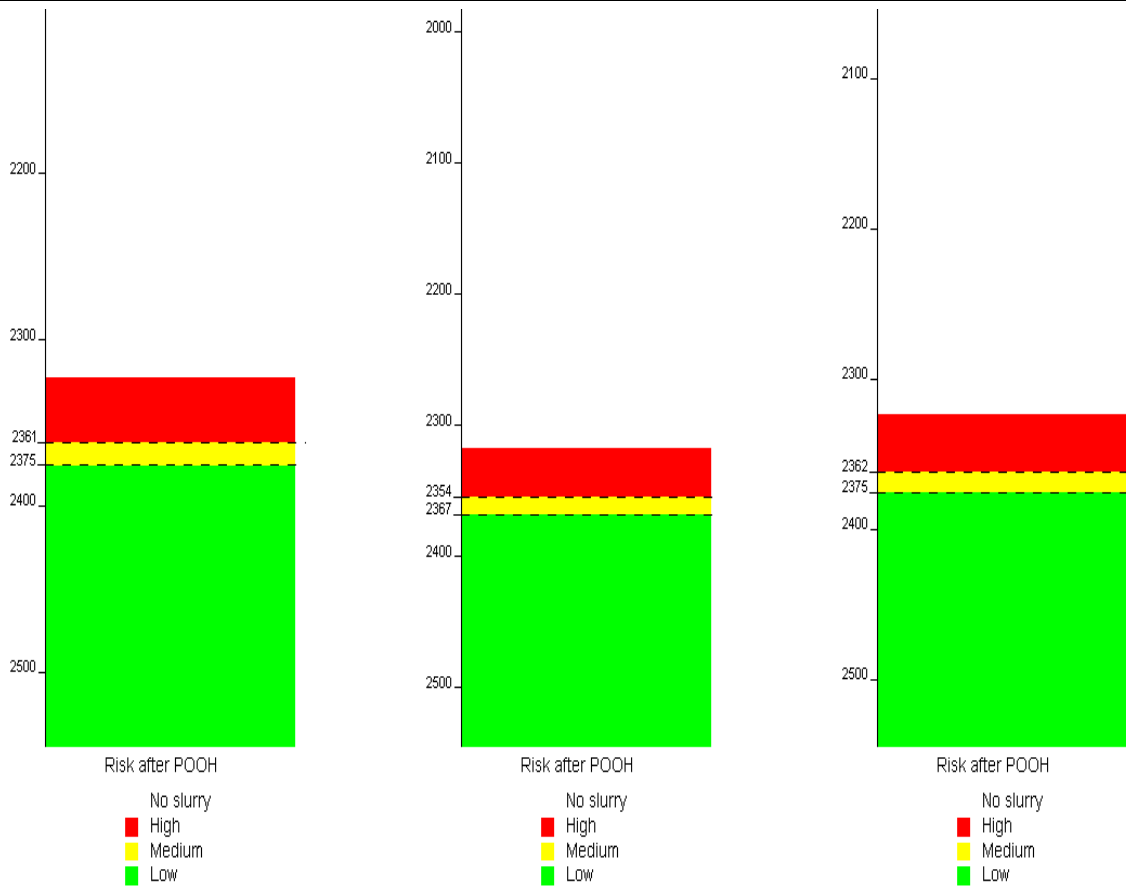

Figure B.12: POOH results case 34-36 Note : Simulation assumes that fluids are free to balance themselves

FINAL CONTAMINATION RISK (AFTER POOH) DLS: 3.0 degree / 30 meters Angle into res: 80 degrees

Table B.13: POOH results case 37-39

37. POOH Summary - Stinger size ID: 3.3inch - Stinger length: 150 meters			
Final DP depth :	2166.8 m	Theoretical Top of Plug:	2375.0 m
Theoretical Top of Plug (based on slurry volume)		2375.0 m	
Initial Top of Plug from POOH (Uncontaminated POOH Simulation)		2375.4 m	
Estimated Top of Cement after POOH (Final POOH Simulation)		2385.9 m	
38. POOH Summary - Stinger size ID: 3.8inch - Stinger length: 150 meters			
Final DP depth :	2184.0 m	Theoretical Top of Plug:	2375.0 m
Theoretical Top of Plug (based on slurry volume)		2375.0 m	
Initial Top of Plug from POOH (Uncontaminated POOH Simulation)		2375.0 m	
Estimated Top of Cement after POOH (Final POOH Simulation)		2390.0 m	
39. POOH Summary - Stinger size ID: 3.3inch - Stinger length: 300 meters			
Final DP depth :	2112.0 m	Theoretical Top of Plug:	2375.0 m
Theoretical Top of Plug (based on slurry volume)		2375.0 m	
Initial Top of Plug from POOH (Uncontaminated POOH Simulation)		2375.1 m	
Estimated Top of Cement after POOH (Final POOH Simulation)		2394.6 m	

Final Contamination Risk (from left to right: 37,38,39)

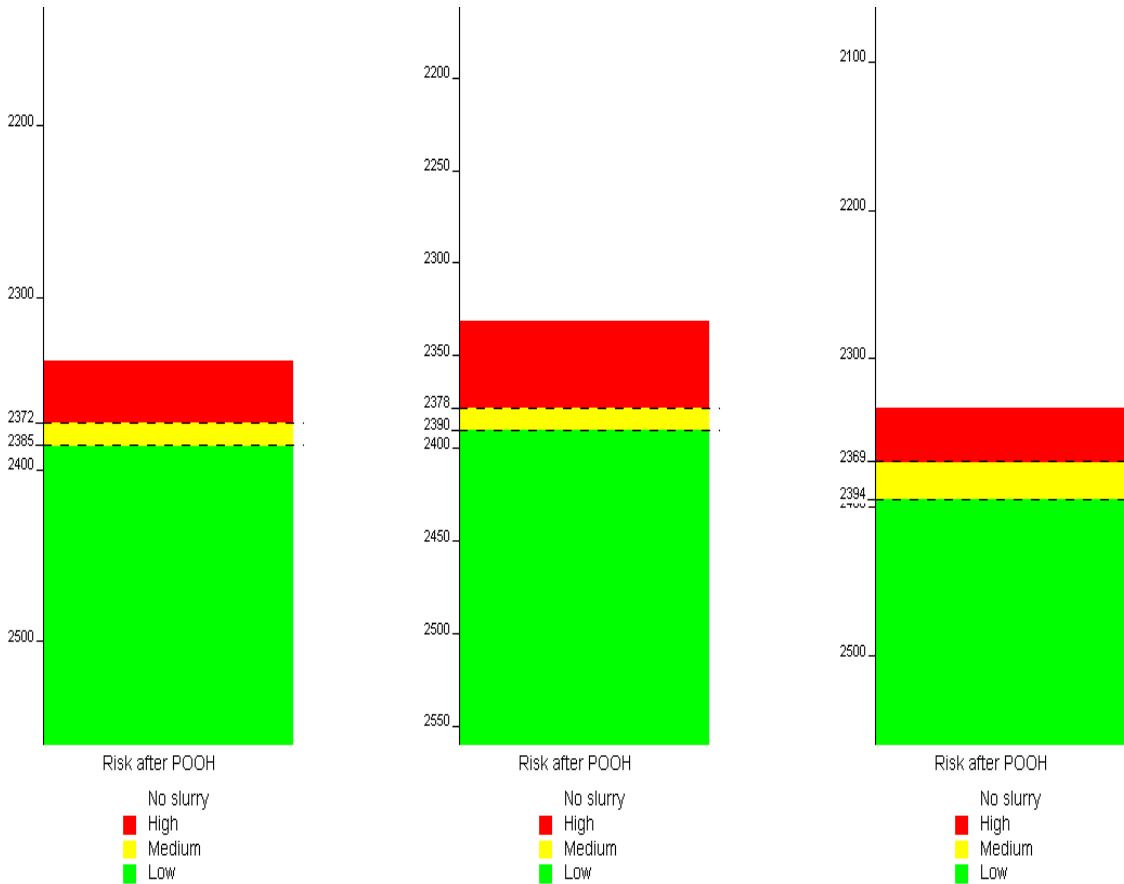

Figure B.13: POOH results case 37-39 Note : Simulation assumes that fluids are free to balance themselves

FINAL CONTAMINATION RISK (AFTER POOH) DLS: 3.0 degree / 30 meters Angle into res: 80 degrees

Table B.14: POOH results case 40-42

40. POOH Summary - Stinger size ID: 3.8inch - Stinger length: 300 meters			
Final DP depth :	2145.1 m	Theoretical Top of Plug:	2375.0 m
Theoretical Top of Plug (based on slurry volume)			2375.0 m
Initial Top of Plug from POOH (Uncontaminated POOH Simulation)			2375.0 m
Estimated Top of Cement after POOH (Final POOH Simulation)			2388.6 m
41. POOH Summary - Stinger size ID: 3.3inch - Stinger length: 450 meters			
Final DP depth :	2047.4 m	Theoretical Top of Plug:	2375.0 m
Theoretical Top of Plug (based on slurry volume)			2375.0 m
Initial Top of Plug from POOH (Uncontaminated POOH Simulation)			2375.1 m
Estimated Top of Cement after POOH (Final POOH Simulation)			2394.6 m
42. POOH Summary - Stinger size ID: 3.8inch - Stinger length: 450 meters			
Final DP depth :	2122.8 m	Theoretical Top of Plug:	2375.0 m
Theoretical Top of Plug (based on slurry volume)			2375.0 m
Initial Top of Plug from POOH (Uncontaminated POOH Simulation)			2375.0 m
Estimated Top of Cement after POOH (Final POOH Simulation)			2388.7 m

Final Contamination Risk (from left to right: 40,41,42)

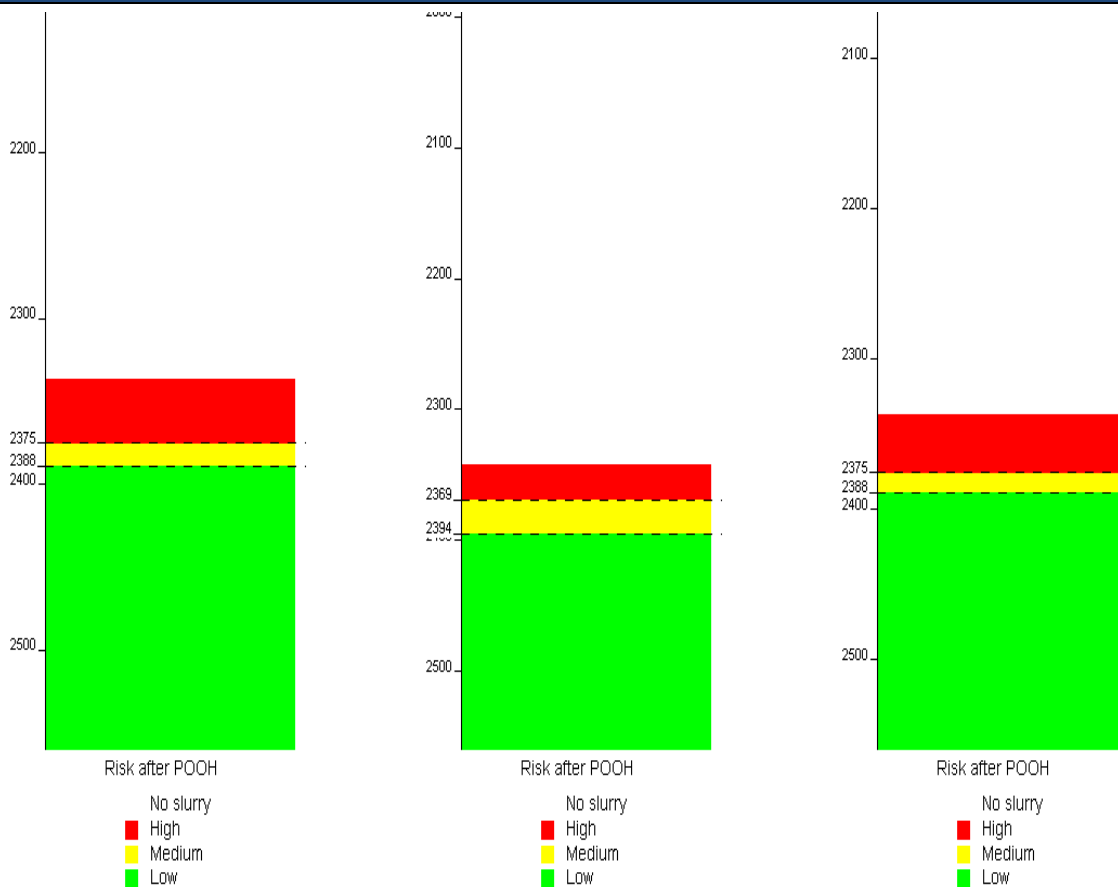

Figure B.14: POOH results case 40-42 Note : Simulation assumes that fluids are free to balance themselves

FINAL CONTAMINATION RISK (AFTER POOH) DLS: 3.0 degree / 30 meters Angle into res: 90 degrees

Table B.15: POOH results case 43-45

43. POOH Summary - Stinger size ID: 3.3inch - Stinger length: 150 meters			
Final DP depth :	2166.8 m	Theoretical Top of Plug:	2375.0 m
Theoretical Top of Plug (based on slurry volume)		2375.0 m	
Initial Top of Plug from POOH (Uncontaminated POOH Simulation)		2375.4 m	
Estimated Top of Cement after POOH (Final POOH Simulation)		2385.9 m	
44. POOH Summary - Stinger size ID: 3.8inch - Stinger length: 150 meters			
Final DP depth :	2184.0 m	Theoretical Top of Plug:	2375.0 m
Theoretical Top of Plug (based on slurry volume)		2375.0 m	
Initial Top of Plug from POOH (Uncontaminated POOH Simulation)		2375.0 m	
Estimated Top of Cement after POOH (Final POOH Simulation)		2390.0 m	
45. POOH Summary - Stinger size ID: 3.3inch - Stinger length: 300 meters			
Final DP depth :	2112.0 m	Theoretical Top of Plug:	2375.0 m
Theoretical Top of Plug (based on slurry volume)		2375.0 m	
Initial Top of Plug from POOH (Uncontaminated POOH Simulation)		2375.1 m	
Estimated Top of Cement after POOH (Final POOH Simulation)		2394.6 m	

Final Contamination Risk (from left to right: 43,44,45)

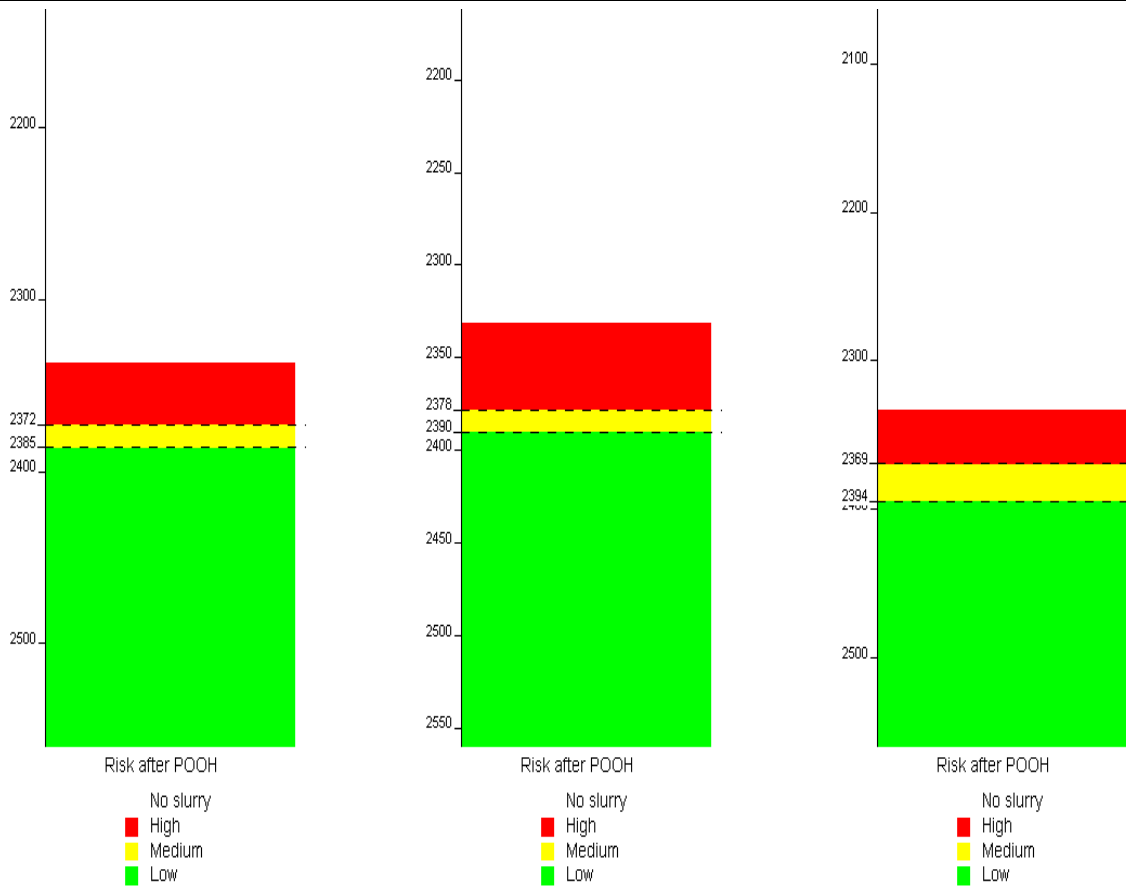

Figure B.15: POOH results case 43-45 Note : Simulation assumes that fluids are free to balance themselves

FINAL CONTAMINATION RISK (AFTER POOH) DLS: 3.0 degree / 30 meters Angle into res: 90 degrees

Table B.16: POOH results case 46-48

46. POOH Summary - Stinger size ID: 3.8inch - Stinger length: 300 meters			
Final DP depth :	2145.1 m	Theoretical Top of Plug:	2375.0 m
Theoretical Top of Plug (based on slurry volume)		2375.0 m	
Initial Top of Plug from POOH (Uncontaminated POOH Simulation)		2375.0 m	
Estimated Top of Cement after POOH (Final POOH Simulation)		2388.6 m	
47. POOH Summary - Stinger size ID: 3.3inch - Stinger length: 450 meters			
Final DP depth :	2047.4 m	Theoretical Top of Plug:	2375.0 m
Theoretical Top of Plug (based on slurry volume)		2375.0 m	
Initial Top of Plug from POOH (Uncontaminated POOH Simulation)		2375.1 m	
Estimated Top of Cement after POOH (Final POOH Simulation)		2394.6 m	
48. POOH Summary - Stinger size ID: 3.8inch - Stinger length: 450 meters			
Final DP depth :	2122.8 m	Theoretical Top of Plug:	2375.0 m
Theoretical Top of Plug (based on slurry volume)		2375.0 m	
Initial Top of Plug from POOH (Uncontaminated POOH Simulation)		2375.0 m	
Estimated Top of Cement after POOH (Final POOH Simulation)		2388.7 m	

Final Contamination Risk (from left to right: 46,47,48)

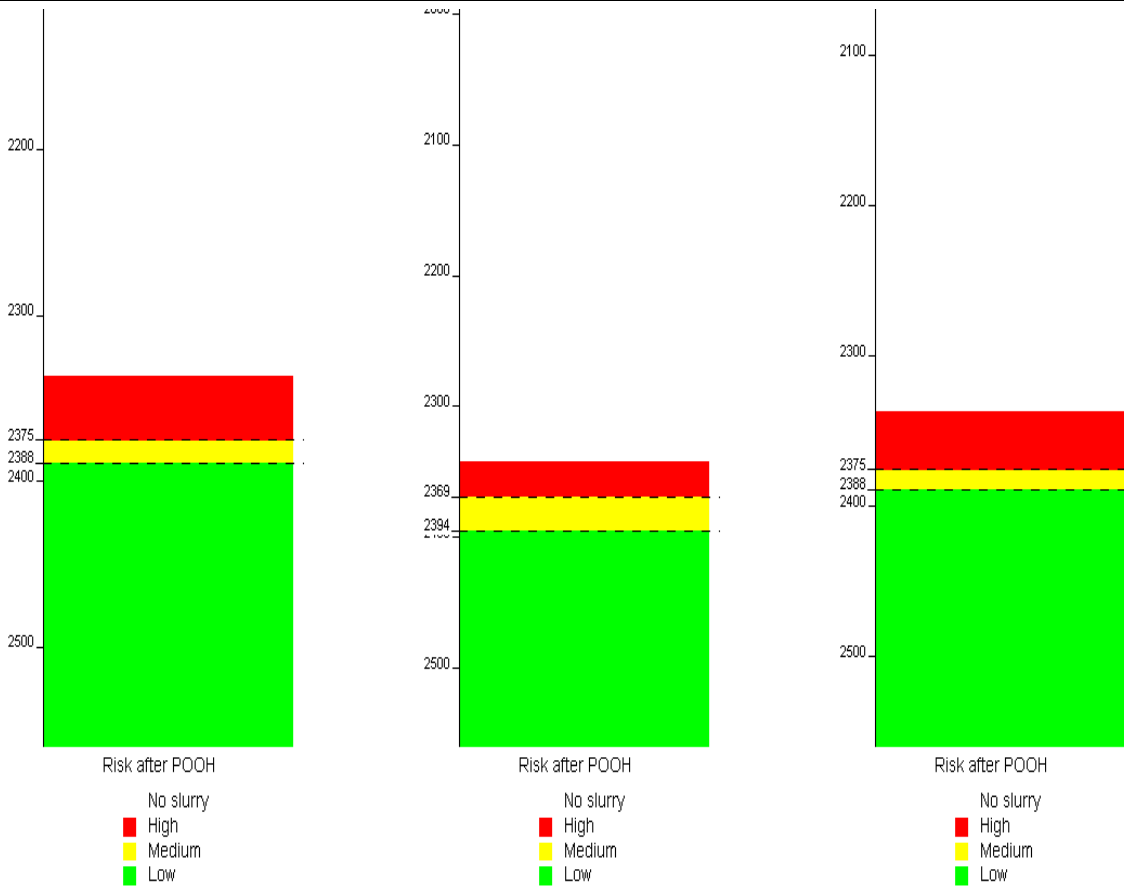

Figure B.16: POOH results case 46-48 Note : Simulation assumes that fluids are free to balance themselves

FINAL CONTAMINATION RISK (AFTER POOH) DLS: 4.2 degree / 30 meters Angle into res: 60 degrees

Table B.17: POOH results case 49-51

49. POOH Summary - Stinger size ID: 3.3inch - Stinger length: 150 meters			
Final DP depth :	2065.9 m	Theoretical Top of Plug:	2270.0 m
Theoretical Top of Plug (based on slurry volume)		2270.0 m	
Initial Top of Plug from POOH (Uncontaminated POOH Simulation)		2270.2 m	
Estimated Top of Cement after POOH (Final POOH Simulation)		2285.2 m	
50. POOH Summary - Stinger size ID: 3.8inch - Stinger length: 150 meters			
Final DP depth :	2081.6 m	Theoretical Top of Plug:	2270.0 m
Theoretical Top of Plug (based on slurry volume)		2270.0 m	
Initial Top of Plug from POOH (Uncontaminated POOH Simulation)		2270.0 m	
Estimated Top of Cement after POOH (Final POOH Simulation)		2290.9 m	
51. POOH Summary - Stinger size ID: 3.3inch - Stinger length: 300 meters			
Final DP depth :	2014.7 m	Theoretical Top of Plug:	2270.0 m
Theoretical Top of Plug (based on slurry volume)		2270.0 m	
Initial Top of Plug from POOH (Uncontaminated POOH Simulation)		2270.2 m	
Estimated Top of Cement after POOH (Final POOH Simulation)		2283.7 m	

Final Contamination Risk (from left to right: 49,50,51)

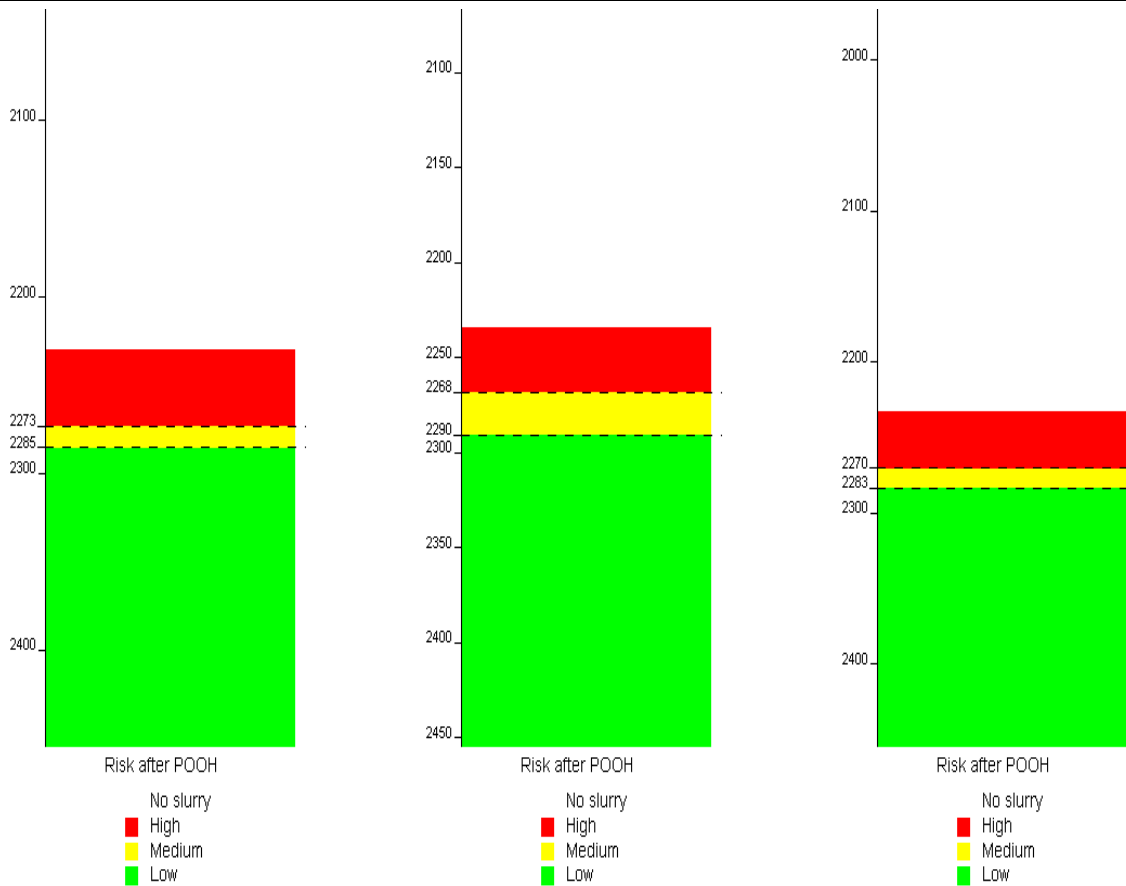

Figure B.17: POOH results case 49-51 Note : Simulation assumes that fluids are free to balance themselves

FINAL CONTAMINATION RISK (AFTER POOH) DLS: 4.2 degree / 30 meters Angle into res: 60 degrees

Table B.18: POOH results case 52-54

52. POOH Summary - Stinger size ID: 3.8inch - Stinger length: 300 meters			
Final DP depth :	2044.6 m	Theoretical Top of Plug:	2270.0 m
Theoretical Top of Plug (based on slurry volume)		2270.0 m	
Initial Top of Plug from POOH (Uncontaminated POOH Simulation)		2270.0 m	
Estimated Top of Cement after POOH (Final POOH Simulation)		2289.6 m	
53. POOH Summary - Stinger size ID: 3.3inch - Stinger length: 450 meters			
Final DP depth :	1955.2 m	Theoretical Top of Plug:	2270.0 m
Theoretical Top of Plug (based on slurry volume)		2270.0 m	
Initial Top of Plug from POOH (Uncontaminated POOH Simulation)		2270.0 m	
Estimated Top of Cement after POOH (Final POOH Simulation)		2283.9 m	
54. POOH Summary - Stinger size ID: 3.8inch - Stinger length: 450 meters			
Final DP depth :	2024.6 m	Theoretical Top of Plug:	2270.0 m
Theoretical Top of Plug (based on slurry volume)		2270.0 m	
Initial Top of Plug from POOH (Uncontaminated POOH Simulation)		2270.0 m	
Estimated Top of Cement after POOH (Final POOH Simulation)		2287.9 m	

Final Contamination Risk (from left to right: 52,53,54)

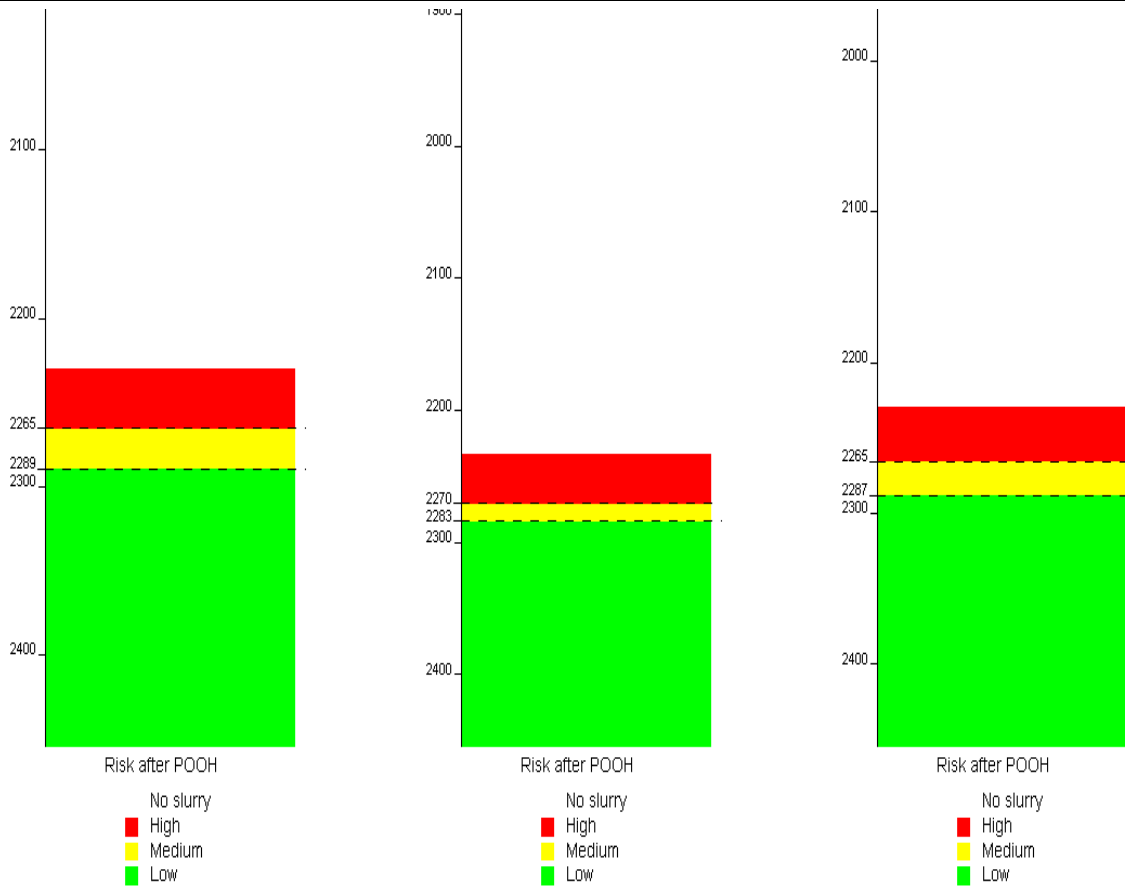

Figure B.18: POOH results case 52-54 Note : Simulation assumes that fluids are free to balance themselves

FINAL CONTAMINATION RISK (AFTER POOH) DLS: 4.2 degree / 30 meters Angle into res: 70 degrees

Table B.19: POOH results case 55-57

55. POOH Summary - Stinger size ID: 3.3inch - Stinger length: 150 meters			
Final DP depth :	2085.4 m	Theoretical Top of Plug:	2290.0 m
Theoretical Top of Plug (based on slurry volume)		2290.0 m	
Initial Top of Plug from POOH (Uncontaminated POOH Simulation)		2290.0 m	
Estimated Top of Cement after POOH (Final POOH Simulation)		2305.0 m	
56. POOH Summary - Stinger size ID: 3.8inch - Stinger length: 150 meters			
Final DP depth :	2101.2 m	Theoretical Top of Plug:	2290.0 m
Theoretical Top of Plug (based on slurry volume)		2290.0 m	
Initial Top of Plug from POOH (Uncontaminated POOH Simulation)		2290.0 m	
Estimated Top of Cement after POOH (Final POOH Simulation)		2309.9 m	
57. POOH Summary - Stinger size ID: 3.3inch - Stinger length: 300 meters			
Final DP depth :	2033.7 m	Theoretical Top of Plug:	2290.0 m
Theoretical Top of Plug (based on slurry volume)		2290.0 m	
Initial Top of Plug from POOH (Uncontaminated POOH Simulation)		2290.0 m	
Estimated Top of Cement after POOH (Final POOH Simulation)		2302.4 m	

Final Contamination Risk (from left to right: 55,56,57)

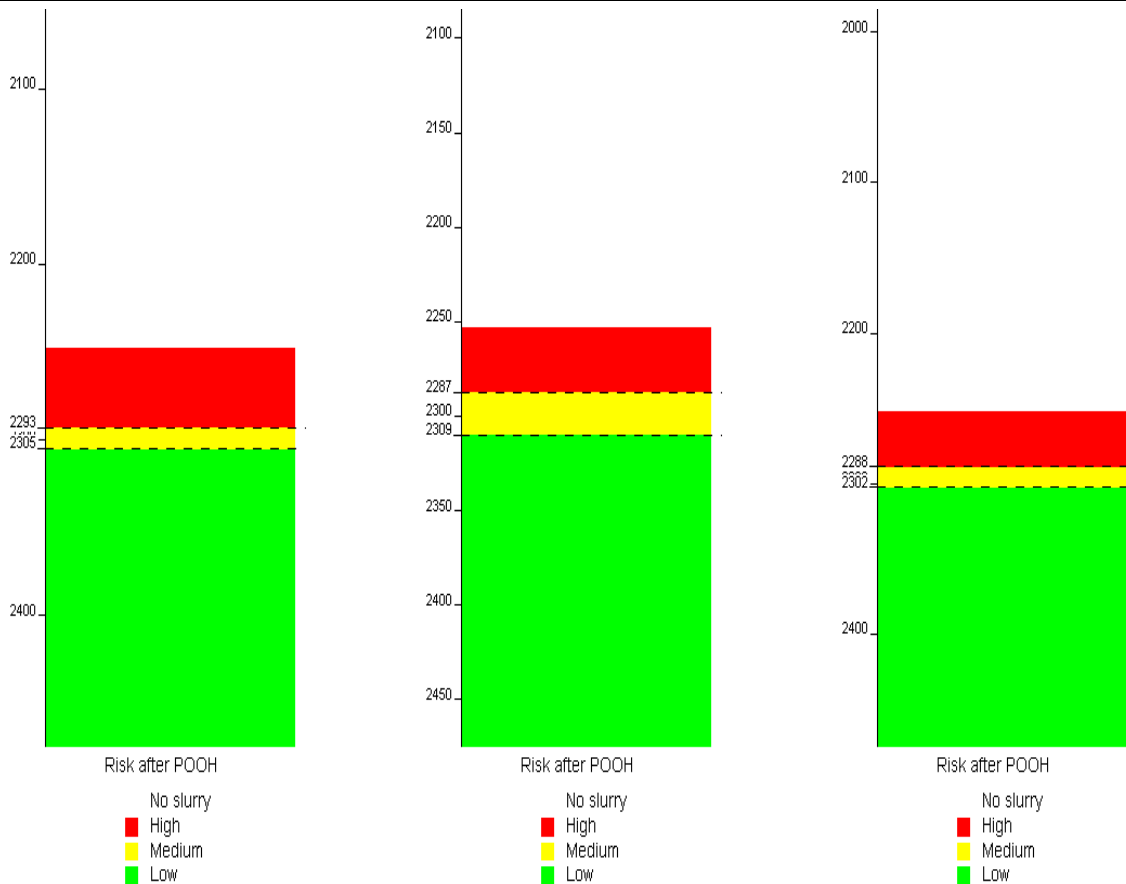

Figure B.19: POOH results case 55-57 Note : Simulation assumes that fluids are free to balance themselves

FINAL CONTAMINATION RISK (AFTER POOH) DLS: 4.2 degree / 30 meters Angle into res: 70 degrees

Table B.20: POOH results case 58-60

58. POOH Summary - Stinger size ID: 3.8inch - Stinger length: 300 meters			
Final DP depth :	2064.0 m	Theoretical Top of Plug:	2290.0 m
Theoretical Top of Plug (based on slurry volume)		2290.0 m	
Initial Top of Plug from POOH (Uncontaminated POOH Simulation)		2290.0 m	
Estimated Top of Cement after POOH (Final POOH Simulation)		2308.5 m	
59. POOH Summary - Stinger size ID: 3.3inch - Stinger length: 450 meters			
Final DP depth :	1973.6 m	Theoretical Top of Plug:	2290.0 m
Theoretical Top of Plug (based on slurry volume)		2290.0 m	
Initial Top of Plug from POOH (Uncontaminated POOH Simulation)		2290.0 m	
Estimated Top of Cement after POOH (Final POOH Simulation)		2302.3 m	
60. POOH Summary - Stinger size ID: 3.8inch - Stinger length: 450 meters			
Final DP depth :	2043.7 m	Theoretical Top of Plug:	2290.0 m
Theoretical Top of Plug (based on slurry volume)		2290.0 m	
Initial Top of Plug from POOH (Uncontaminated POOH Simulation)		2290.0 m	
Estimated Top of Cement after POOH (Final POOH Simulation)		2308.2 m	

Final Contamination Risk (from left to right: 58,59,60)

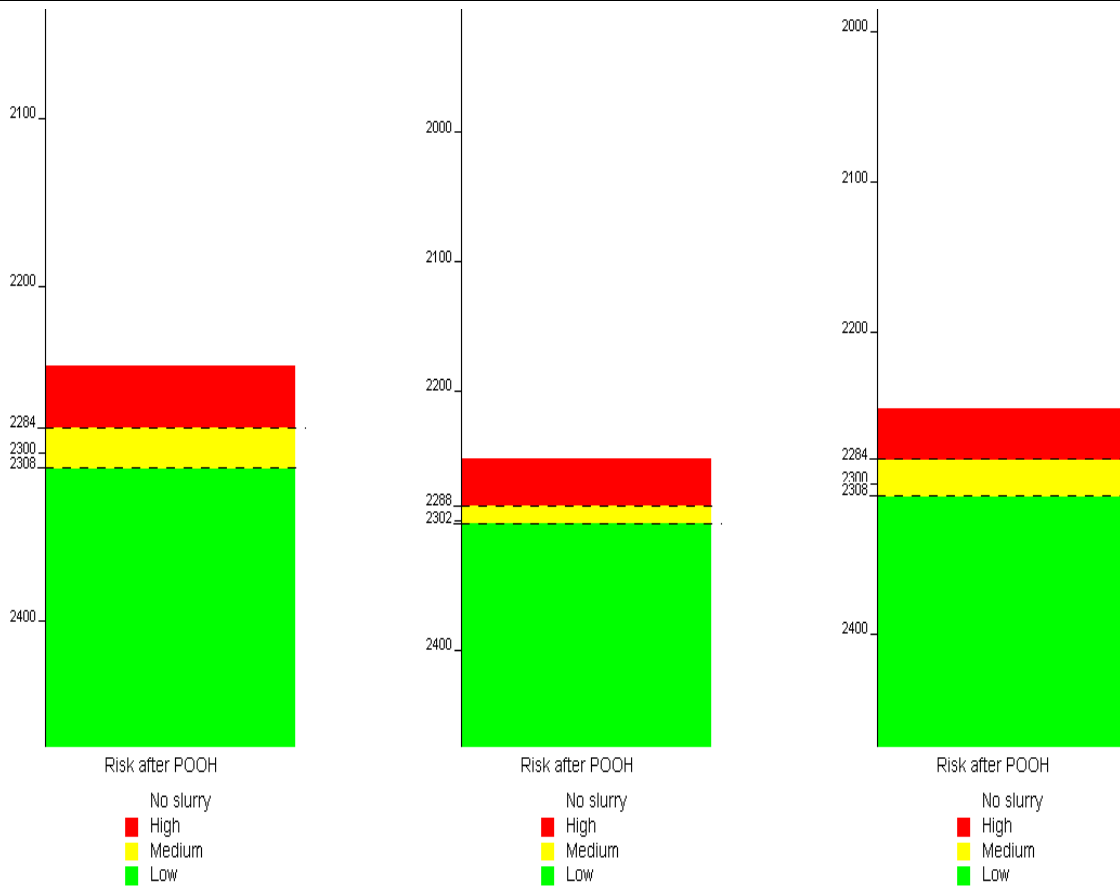

Figure B.20: POOH results case 58-60 Note : Simulation assumes that fluids are free to balance themselves

FINAL CONTAMINATION RISK (AFTER POOH) DLS: 4.2 degree / 30 meters Angle into res: 80 degrees

Table B.21: POOH results case 61-63

61. POOH Summary - Stinger size ID: 3.3inch - Stinger length: 150 meters			
Final DP depth :	2090.2 m	Theoretical Top of Plug:	2295.0 m
Theoretical Top of Plug (based on slurry volume)			2295.0 m
Initial Top of Plug from POOH (Uncontaminated POOH Simulation)			2295.0 m
Estimated Top of Cement after POOH (Final POOH Simulation)			2309.9 m
62. POOH Summary - Stinger size ID: 3.8inch - Stinger length: 150 meters			
Final DP depth :	2106.1 m	Theoretical Top of Plug:	2295.0 m
Theoretical Top of Plug (based on slurry volume)			2295.0 m
Initial Top of Plug from POOH (Uncontaminated POOH Simulation)			2295.0 m
Estimated Top of Cement after POOH (Final POOH Simulation)			2314.8 m
63. POOH Summary - Stinger size ID: 3.3inch - Stinger length: 300 meters			
Final DP depth :	2038.5 m	Theoretical Top of Plug:	2295.0 m
Theoretical Top of Plug (based on slurry volume)			2295.0 m
Initial Top of Plug from POOH (Uncontaminated POOH Simulation)			2295.0 m
Estimated Top of Cement after POOH (Final POOH Simulation)			2307.3 m

Final Contamination Risk (from left to right: 61,62,63)

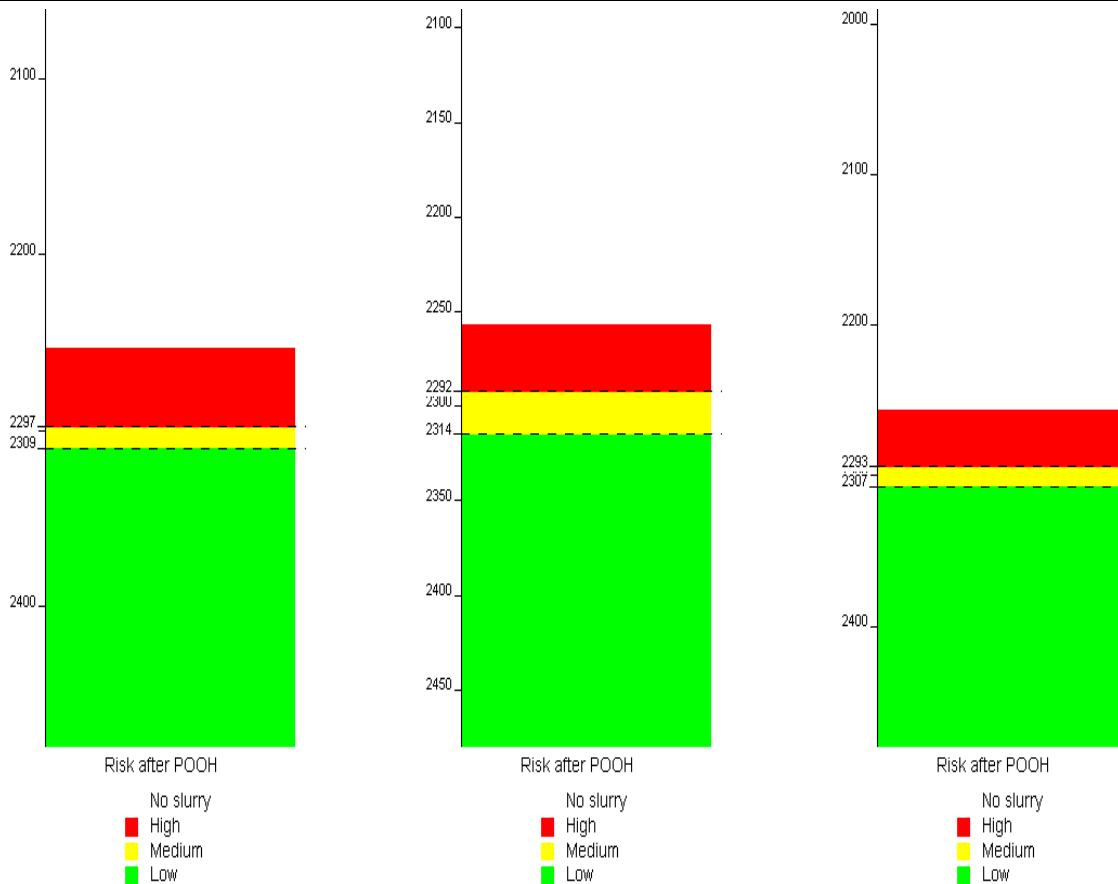

Figure B.21: POOH results case 61-63 Note : Simulation assumes that fluids are free to balance themselves

FINAL CONTAMINATION RISK (AFTER POOH) DLS: 4.2 degree / 30 meters Angle into res: 80 degrees

Table B.22: POOH results case 64-66

64. POOH Summary - Stinger size ID: 3.8inch - Stinger length: 300 meters			
Final DP depth :	2068.8 m	Theoretical Top of Plug:	2295.0 m
Theoretical Top of Plug (based on slurry volume)		2295.0 m	
Initial Top of Plug from POOH (Uncontaminated POOH Simulation)		2295.0 m	
Estimated Top of Cement after POOH (Final POOH Simulation)		2313.4 m	
65. POOH Summary - Stinger size ID: 3.3inch - Stinger length: 450 meters			
Final DP depth :	1978.2 m	Theoretical Top of Plug:	2295.0 m
Theoretical Top of Plug (based on slurry volume)		2295.0 m	
Initial Top of Plug from POOH (Uncontaminated POOH Simulation)		2295.2 m	
Estimated Top of Cement after POOH (Final POOH Simulation)		2307.2 m	
66. POOH Summary - Stinger size ID: 3.8inch - Stinger length: 450 meters			
Final DP depth :	2048.5 m	Theoretical Top of Plug:	2295.0 m
Theoretical Top of Plug (based on slurry volume)		2295.0 m	
Initial Top of Plug from POOH (Uncontaminated POOH Simulation)		2295.0 m	
Estimated Top of Cement after POOH (Final POOH Simulation)		2313.1 m	

Final Contamination Risk (from left to right: 64,65,66)

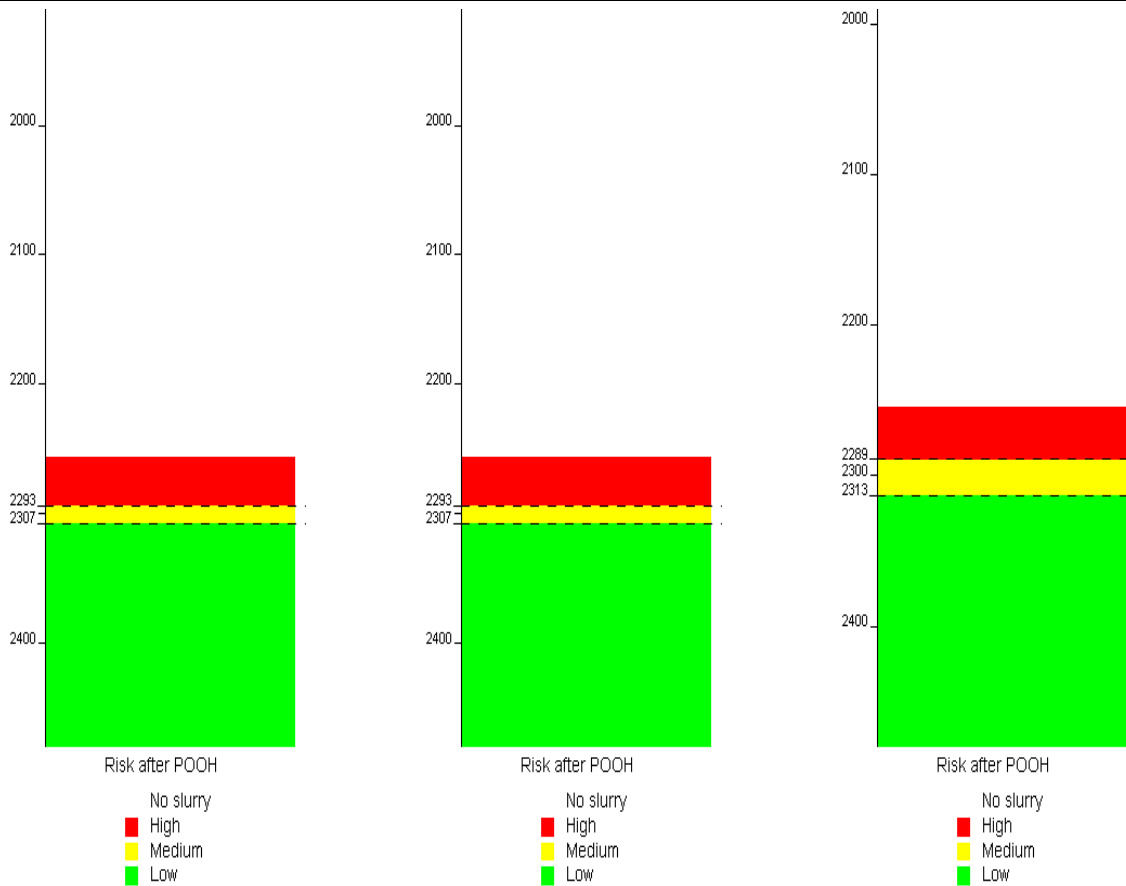

Figure B.22: POOH results case 64-66 Note : Simulation assumes that fluids are free to balance themselves

FINAL CONTAMINATION RISK (AFTER POOH) DLS: 4.2 degree / 30 meters Angle into res: 90 degrees

Table B.23: POOH results case 67-69

67. POOH Summary - Stinger size ID: 3.3inch - Stinger length: 150 meters			
Final DP depth :	2074.0 m	Theoretical Top of Plug:	2295.0 m
Theoretical Top of Plug (based on slurry volume)		2295.0 m	
Initial Top of Plug from POOH (Uncontaminated POOH Simulation)		2295.0 m	
Estimated Top of Cement after POOH (Final POOH Simulation)		2314.6 m	
68. POOH Summary - Stinger size ID: 3.8inch - Stinger length: 150 meters			
Final DP depth :	2106.1 m	Theoretical Top of Plug:	2295.0 m
Theoretical Top of Plug (based on slurry volume)		2295.0 m	
Initial Top of Plug from POOH (Uncontaminated POOH Simulation)		2295.0 m	
Estimated Top of Cement after POOH (Final POOH Simulation)		2314.8 m	
69. POOH Summary - Stinger size ID: 3.3inch - Stinger length: 300 meters			
Final DP depth :	2038.5 m	Theoretical Top of Plug:	2295.0 m
Theoretical Top of Plug (based on slurry volume)		2295.0 m	
Initial Top of Plug from POOH (Uncontaminated POOH Simulation)		2295.0 m	
Estimated Top of Cement after POOH (Final POOH Simulation)		2307.3 m	

Final Contamination Risk (from left to right: 67,68,69)

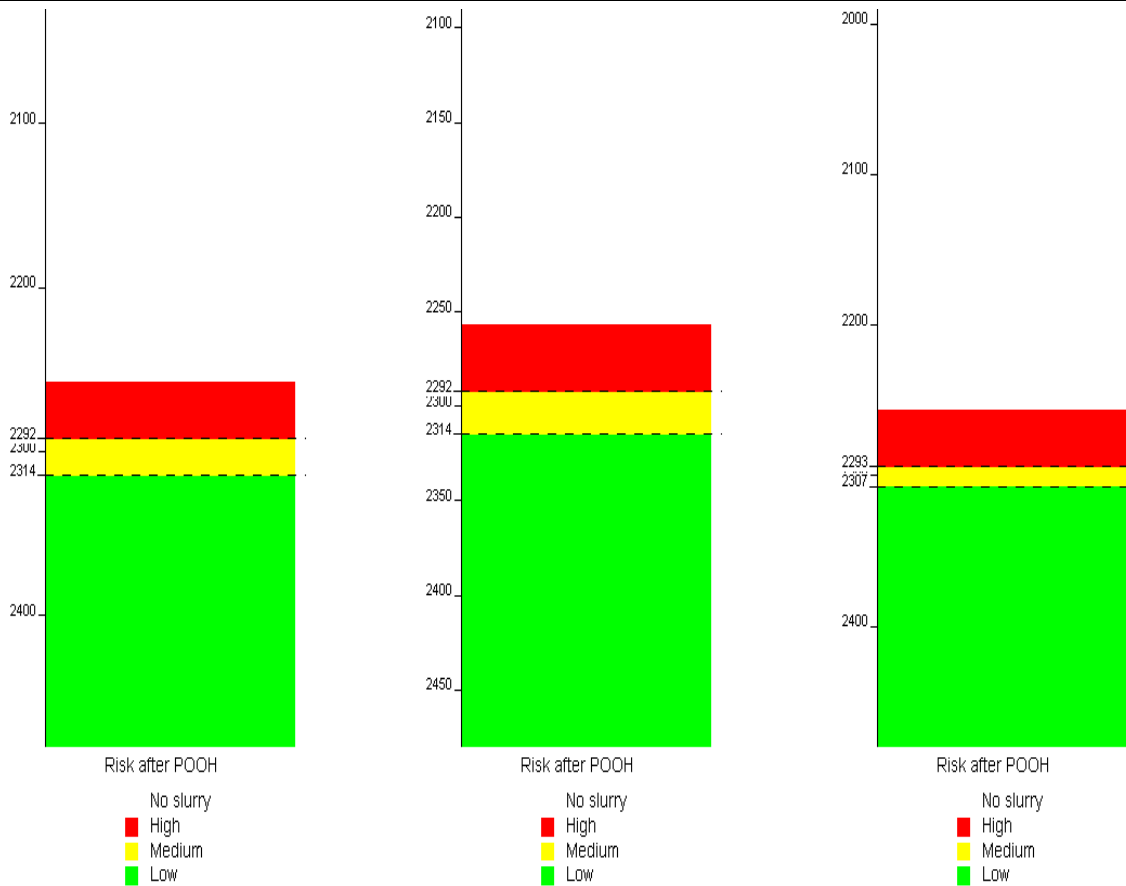

Figure B.23: POOH results case 67-69 Note : Simulation assumes that fluids are free to balance themselves

FINAL CONTAMINATION RISK (AFTER POOH) DLS: 4.2 degree / 30 meters Angle into res: 90 degrees

Table B.24: POOH results case 70-72

70. POOH Summary - Stinger size ID: 3.8inch - Stinger length: 300 meters			
Final DP depth :	2068.8 m	Theoretical Top of Plug:	2295.0 m
Theoretical Top of Plug (based on slurry volume)			2295.0 m
Initial Top of Plug from POOH (Uncontaminated POOH Simulation)			2295.0 m
Estimated Top of Cement after POOH (Final POOH Simulation)			2313.4 m
71. POOH Summary - Stinger size ID: 3.3inch - Stinger length: 450 meters			
Final DP depth :	1978.2 m	Theoretical Top of Plug:	2295.0 m
Theoretical Top of Plug (based on slurry volume)			2295.0 m
Initial Top of Plug from POOH (Uncontaminated POOH Simulation)			2295.2 m
Estimated Top of Cement after POOH (Final POOH Simulation)			2307.2 m
72. POOH Summary - Stinger size ID: 3.8inch - Stinger length: 450 meters			
Final DP depth :	2048.5 m	Theoretical Top of Plug:	2295.0 m
Theoretical Top of Plug (based on slurry volume)			2295.0 m
Initial Top of Plug from POOH (Uncontaminated POOH Simulation)			2295.0 m
Estimated Top of Cement after POOH (Final POOH Simulation)			2313.1 m

Final Contamination Risk (from left to right: 70,71,72)

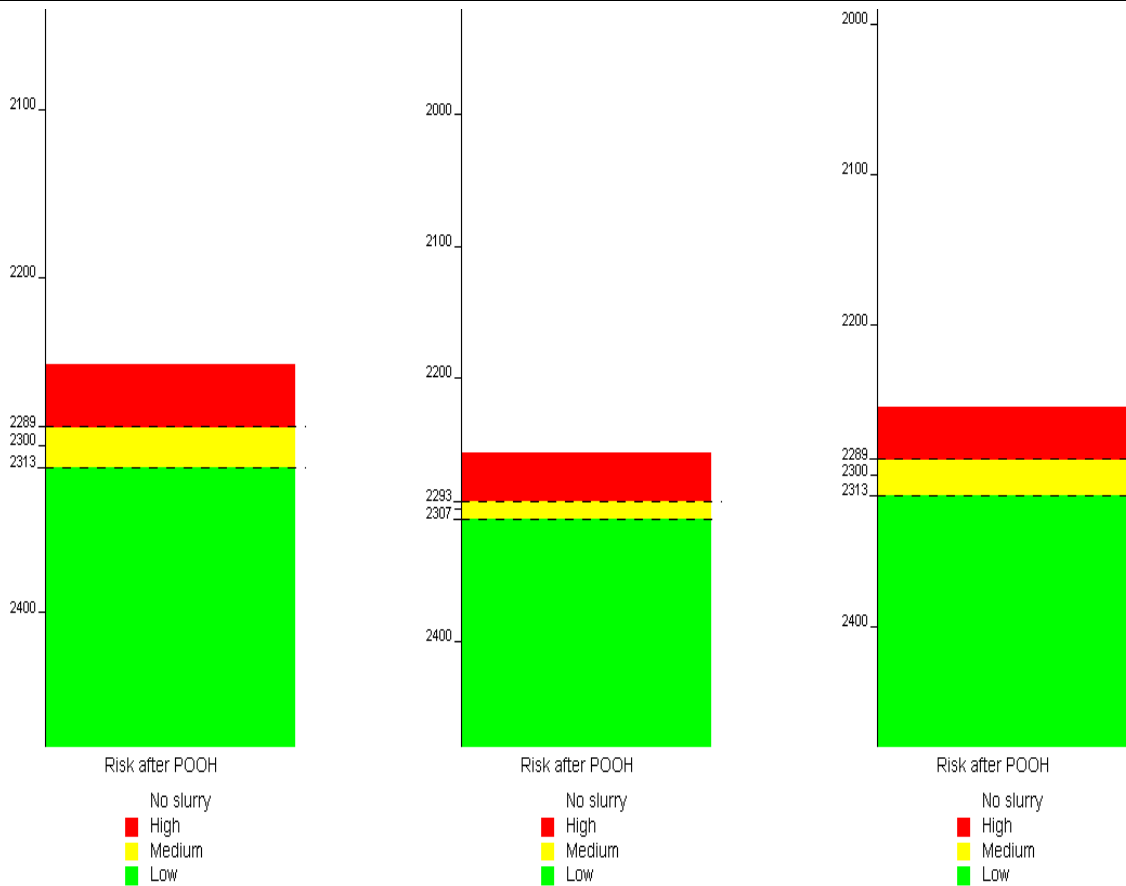

Figure B.24: POOH results case 70-72 Note : Simulation assumes that fluids are free to balance themselves

FINAL CONTAMINATION RISK (AFTER POOH) DLS: 6.0 degree / 30 meters Angle into res: 60 degrees

Table B.25: POOH results case 73-75

73. POOH Summary - Stinger size ID: 3.3inch - Stinger length: 150 meters			
Final DP depth :	2028.5 m	Theoretical Top of Plug:	2230.0 m
Theoretical Top of Plug (based on slurry volume)		2230.0 m	
Initial Top of Plug from POOH (Uncontaminated POOH Simulation)		2230.0 m	
Estimated Top of Cement after POOH (Final POOH Simulation)		2248.0 m	
74. POOH Summary - Stinger size ID: 3.8inch - Stinger length: 150 meters			
Final DP depth :	2043.1 m	Theoretical Top of Plug:	2230.0 m
Theoretical Top of Plug (based on slurry volume)		2230.0 m	
Initial Top of Plug from POOH (Uncontaminated POOH Simulation)		2230.0 m	
Estimated Top of Cement after POOH (Final POOH Simulation)		2243.3 m	
75. POOH Summary - Stinger size ID: 3.3inch - Stinger length: 300 meters			
Final DP depth :	1978.6 m	Theoretical Top of Plug:	2230.0 m
Theoretical Top of Plug (based on slurry volume)		2230.0 m	
Initial Top of Plug from POOH (Uncontaminated POOH Simulation)		2230.0 m	
Estimated Top of Cement after POOH (Final POOH Simulation)		2246.5 m	

Final Contamination Risk (from left to right: 73,74,75)

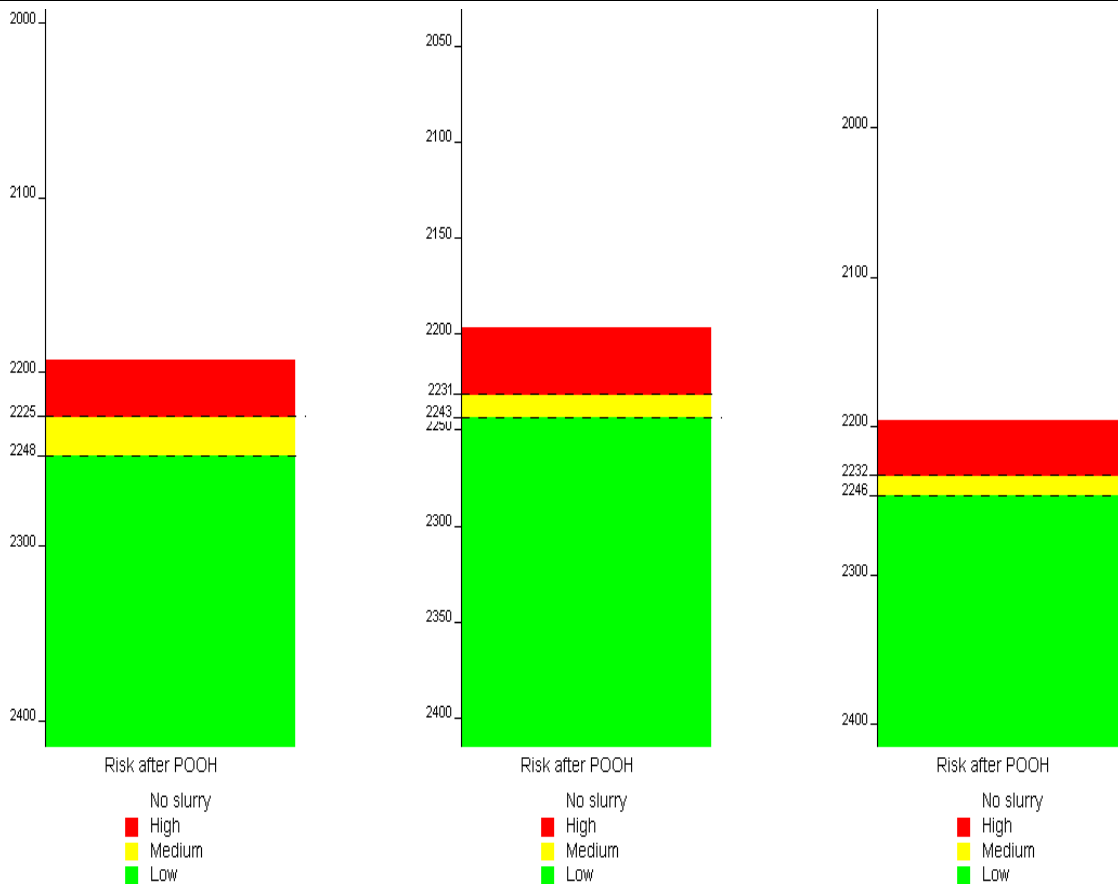

Figure B.25: POOH results case 73-75 Note : Simulation assumes that fluids are free to balance themselves

FINAL CONTAMINATION RISK (AFTER POOH) DLS: 6.0 degree / 30 meters Angle into res: 60 degrees

Table B.26: POOH results case 76-68

76. POOH Summary - Stinger size ID: 3.8inch - Stinger length: 300 meters			
Final DP depth :	2007.1 m	Theoretical Top of Plug:	2230.0 m
Theoretical Top of Plug (based on slurry volume)		2230.0 m	
Initial Top of Plug from POOH (Uncontaminated POOH Simulation)		2230.0 m	
Estimated Top of Cement after POOH (Final POOH Simulation)		2240.4 m	
77. POOH Summary - Stinger size ID: 3.3nch - Stinger length: 450 meters			
Final DP depth :	1921.8 m	Theoretical Top of Plug:	2230.0 m
Theoretical Top of Plug (based on slurry volume)		2230.0 m	
Initial Top of Plug from POOH (Uncontaminated POOH Simulation)		2230.0 m	
Estimated Top of Cement after POOH (Final POOH Simulation)		2245.1 m	
78. POOH Summary - Stinger size ID: 3.8inch - Stinger length: 450 meters			
Final DP depth :	1988.2 m	Theoretical Top of Plug:	2230.0 m
Theoretical Top of Plug (based on slurry volume)		2230.0 m	
Initial Top of Plug from POOH (Uncontaminated POOH Simulation)		2230.0 m	
Estimated Top of Cement after POOH (Final POOH Simulation)		2240.7 m	

Final Contamination Risk (from left to right: 76,77,78)

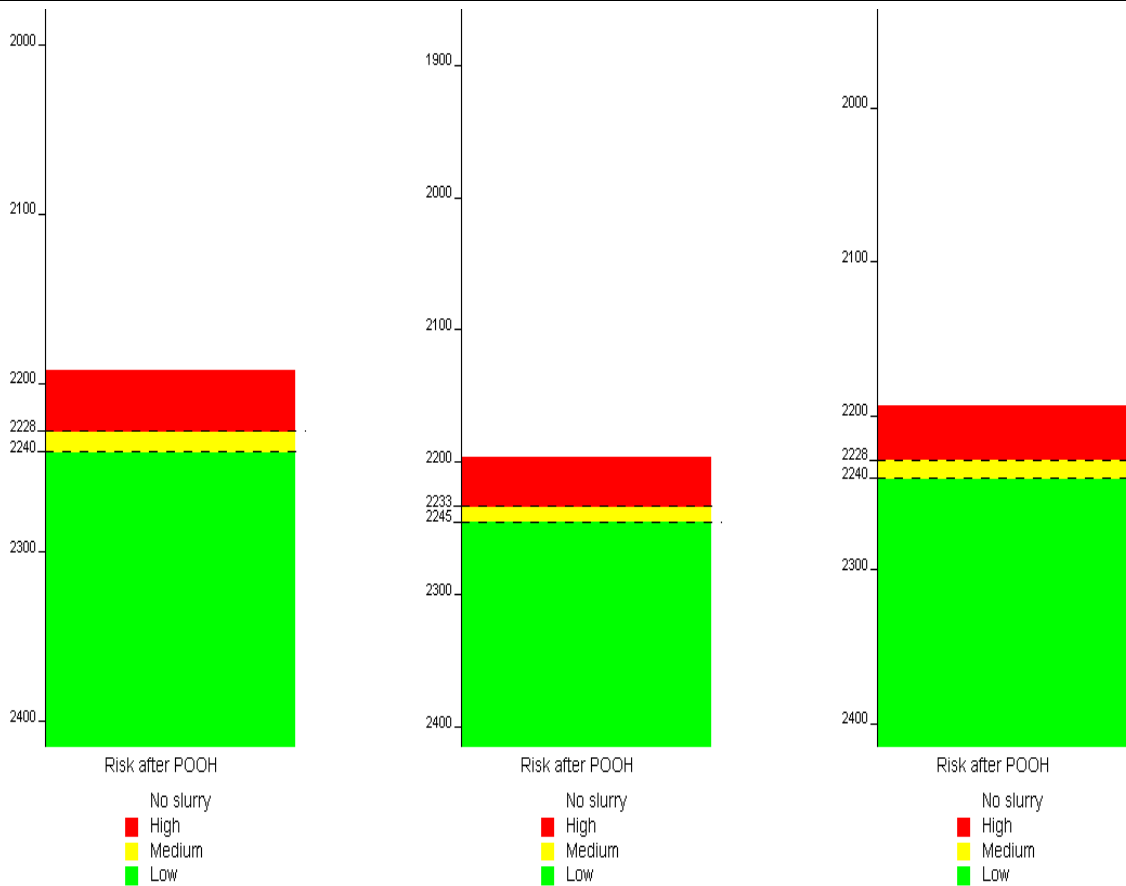

Figure B.26: POOH results case 76-78 Note : Simulation assumes that fluids are free to balance themselves

FINAL CONTAMINATION RISK (AFTER POOH) DLS: 6.0 degree / 30 meters Angle into res: 70 degrees

Table B.27: POOH results case 79-81

79. POOH Summary - Stinger size ID: 3.3inch - Stinger length: 150 meters			
Final DP depth :	2038.2 m	Theoretical Top of Plug:	2240.0 m
Theoretical Top of Plug (based on slurry volume)		2240.0 m	
Initial Top of Plug from POOH (Uncontaminated POOH Simulation)		2240.0 m	
Estimated Top of Cement after POOH (Final POOH Simulation)		2256.4 m	
80. POOH Summary - Stinger size ID: 3.8inch - Stinger length: 150 meters			
Final DP depth :	2053.0 m	Theoretical Top of Plug:	2240.0 m
Theoretical Top of Plug (based on slurry volume)		2240.0 m	
Initial Top of Plug from POOH (Uncontaminated POOH Simulation)		2240.0 m	
Estimated Top of Cement after POOH (Final POOH Simulation)		2252.5 m	
81. POOH Summary - Stinger size ID: 3.3inch - Stinger length: 300 meters			
Final DP depth :	1988.4 m	Theoretical Top of Plug:	2240.0 m
Theoretical Top of Plug (based on slurry volume)		2240.0 m	
Initial Top of Plug from POOH (Uncontaminated POOH Simulation)		2240.0 m	
Estimated Top of Cement after POOH (Final POOH Simulation)		2255.4 m	

Final Contamination Risk (from left to right: 79,80,81)

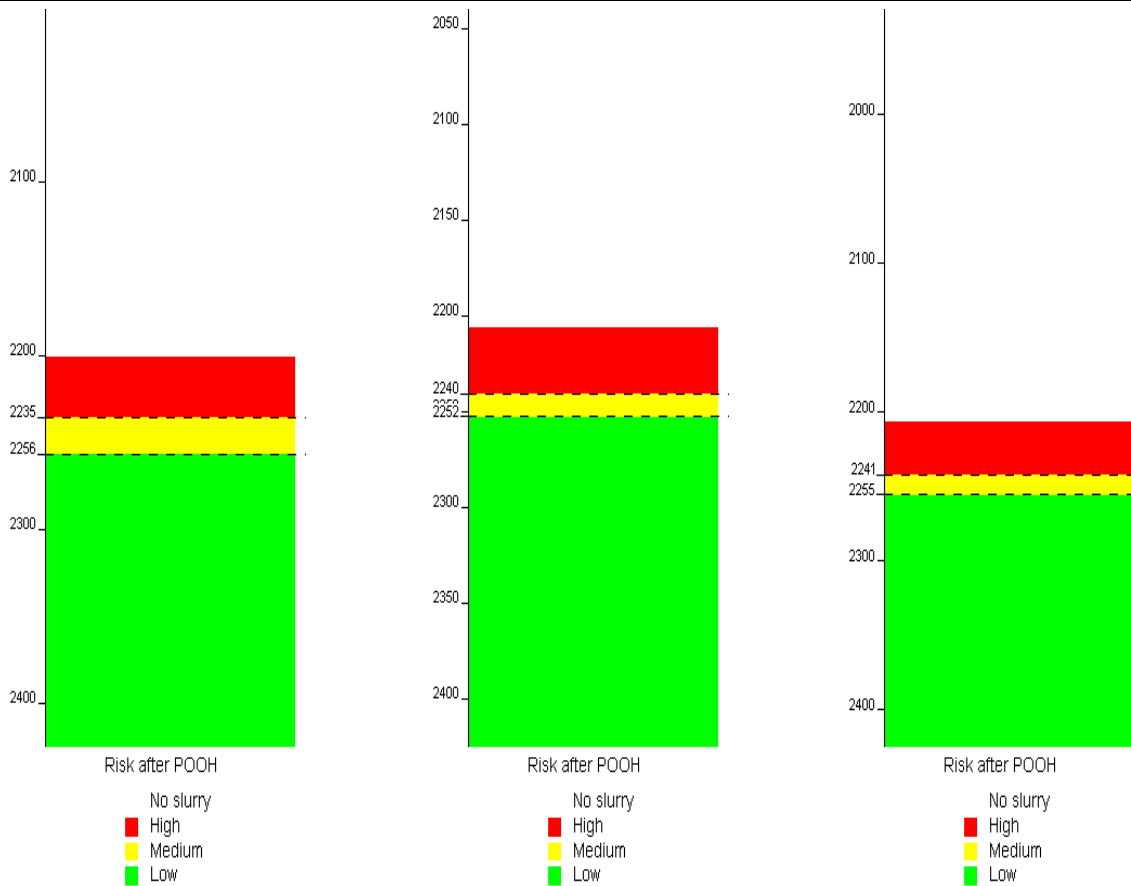

Figure B.27: POOH results case 79-81 Note : Simulation assumes that fluids are free to balance themselves

FINAL CONTAMINATION RISK (AFTER POOH) DLS: 6.0 degree / 30 meters Angle into res: 70 degrees

Table B.28: POOH results case 82-84

82. POOH Summary - Stinger size ID: 3.8inch - Stinger length: 300 meters			
Final DP depth :	2016.9 m	Theoretical Top of Plug:	2240.0 m
Theoretical Top of Plug (based on slurry volume)		2240.0 m	
Initial Top of Plug from POOH (Uncontaminated POOH Simulation)		2240.0 m	
Estimated Top of Cement after POOH (Final POOH Simulation)		2250.9 m	
83. POOH Summary - Stinger size ID: 3.3inch - Stinger length: 450 meters			
Final DP depth :	1931.4 m	Theoretical Top of Plug:	2240.0 m
Theoretical Top of Plug (based on slurry volume)		2240.0 m	
Initial Top of Plug from POOH (Uncontaminated POOH Simulation)		2240.0 m	
Estimated Top of Cement after POOH (Final POOH Simulation)		2255.4 m	
84. POOH Summary - Stinger size ID: 3.8inch - Stinger length: 450 meters			
Final DP depth :	1998.0 m	Theoretical Top of Plug:	2240.0 m
Theoretical Top of Plug (based on slurry volume)		2240.0 m	
Initial Top of Plug from POOH (Uncontaminated POOH Simulation)		2240.0 m	
Estimated Top of Cement after POOH (Final POOH Simulation)		2250.6 m	

Final Contamination Risk (from left to right: 82,83,84)

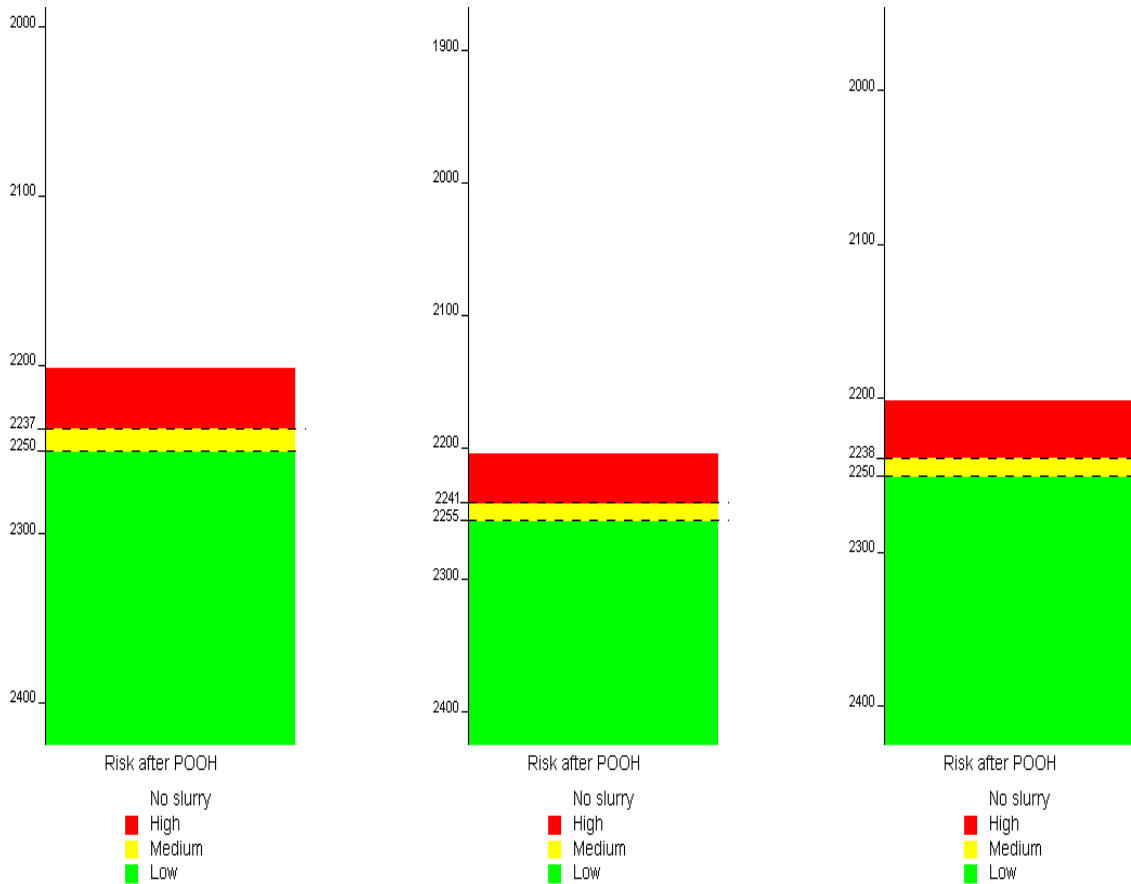

Figure B.28: POOH results case 82-84 Note : Simulation assumes that fluids are free to balance themselves

FINAL CONTAMINATION RISK (AFTER POOH) DLS: 6.0 degree / 30 meters Angle into res: 80 degrees

Table B.29: POOH results case 85-87

85. POOH Summary - Stinger size ID: 3.3inch - Stinger length: 150 meters			
Final DP depth :	2038.2 m	Theoretical Top of Plug:	2240.0 m
Theoretical Top of Plug (based on slurry volume)		2240.0 m	
Initial Top of Plug from POOH (Uncontaminated POOH Simulation)		2240.0 m	
Estimated Top of Cement after POOH (Final POOH Simulation)		2256.4 m	
86. POOH Summary - Stinger size ID: 3.8inch - Stinger length: 150 meters			
Final DP depth :	2053.0 m	Theoretical Top of Plug:	2240.0 m
Theoretical Top of Plug (based on slurry volume)		2240.0 m	
Initial Top of Plug from POOH (Uncontaminated POOH Simulation)		2240.0 m	
Estimated Top of Cement after POOH (Final POOH Simulation)		2252.5 m	
87. POOH Summary - Stinger size ID: 3.3inch - Stinger length: 300 meters			
Final DP depth :	1988.4 m	Theoretical Top of Plug:	2240.0 m
Theoretical Top of Plug (based on slurry volume)		2240.0 m	
Initial Top of Plug from POOH (Uncontaminated POOH Simulation)		2240.0 m	
Estimated Top of Cement after POOH (Final POOH Simulation)		2255.4 m	

Final Contamination Risk (from left to right: 85,86,87)

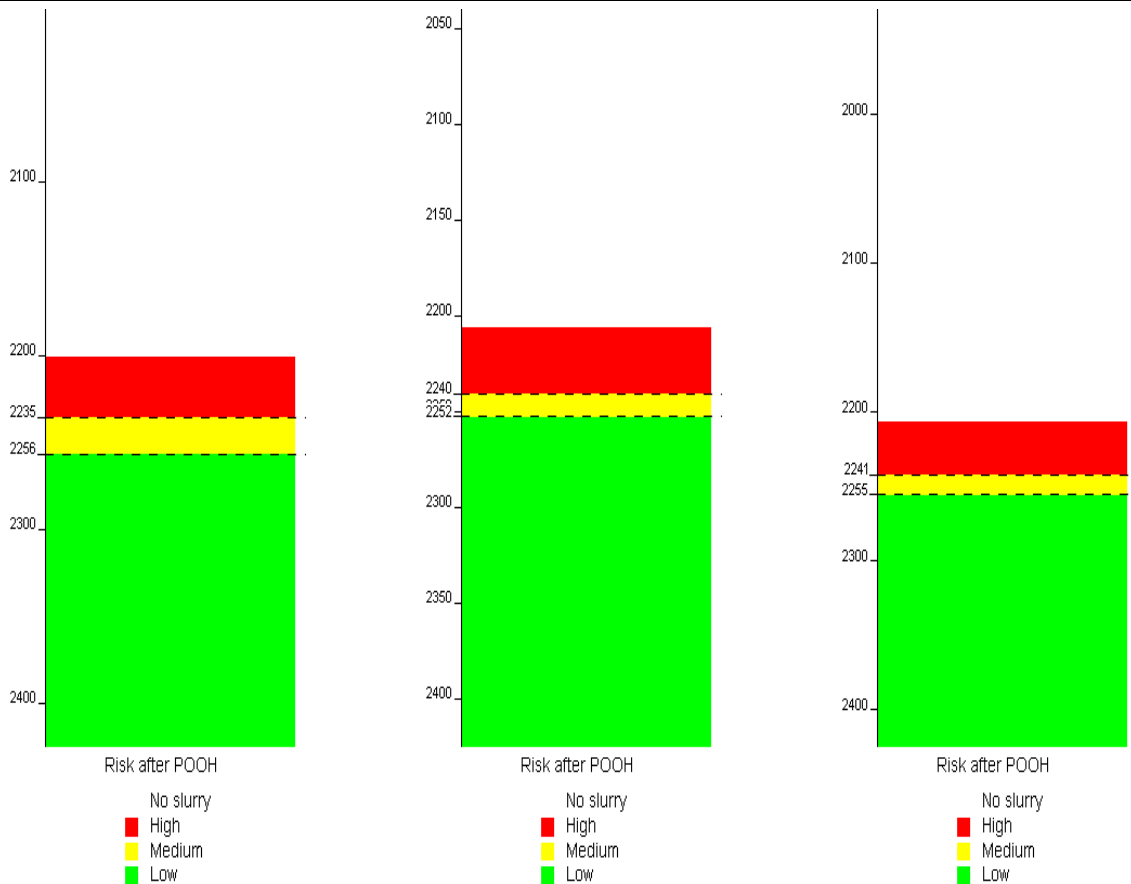

Figure B.29: POOH results case 85-87 Note : Simulation assumes that fluids are free to balance themselves

FINAL CONTAMINATION RISK (AFTER POOH) DLS: 6.0 degree / 30 meters Angle into res: 80 degrees

Table B.30: POOH results case 88-90

88. POOH Summary - Stinger size ID: 3.8inch - Stinger length: 300 meters			
Final DP depth :	2016.9 m	Theoretical Top of Plug:	2240.0 m
Theoretical Top of Plug (based on slurry volume)		2240.0 m	
Initial Top of Plug from POOH (Uncontaminated POOH Simulation)		2240.0 m	
Estimated Top of Cement after POOH (Final POOH Simulation)		2250.9 m	
89. POOH Summary - Stinger size ID: 3.3inch - Stinger length: 450 meters			
Final DP depth :	1931.4 m	Theoretical Top of Plug:	2240.0 m
Theoretical Top of Plug (based on slurry volume)		2240.0 m	
Initial Top of Plug from POOH (Uncontaminated POOH Simulation)		2240.0 m	
Estimated Top of Cement after POOH (Final POOH Simulation)		2255.4 m	
90. POOH Summary - Stinger size ID: 3.8inch - Stinger length: 450 meters			
Final DP depth :	1998.0 m	Theoretical Top of Plug:	2240.0 m
Theoretical Top of Plug (based on slurry volume)		2240.0 m	
Initial Top of Plug from POOH (Uncontaminated POOH Simulation)		2240.0 m	
Estimated Top of Cement after POOH (Final POOH Simulation)		2250.6 m	

Final Contamination Risk (from left to right: 88,89,90)

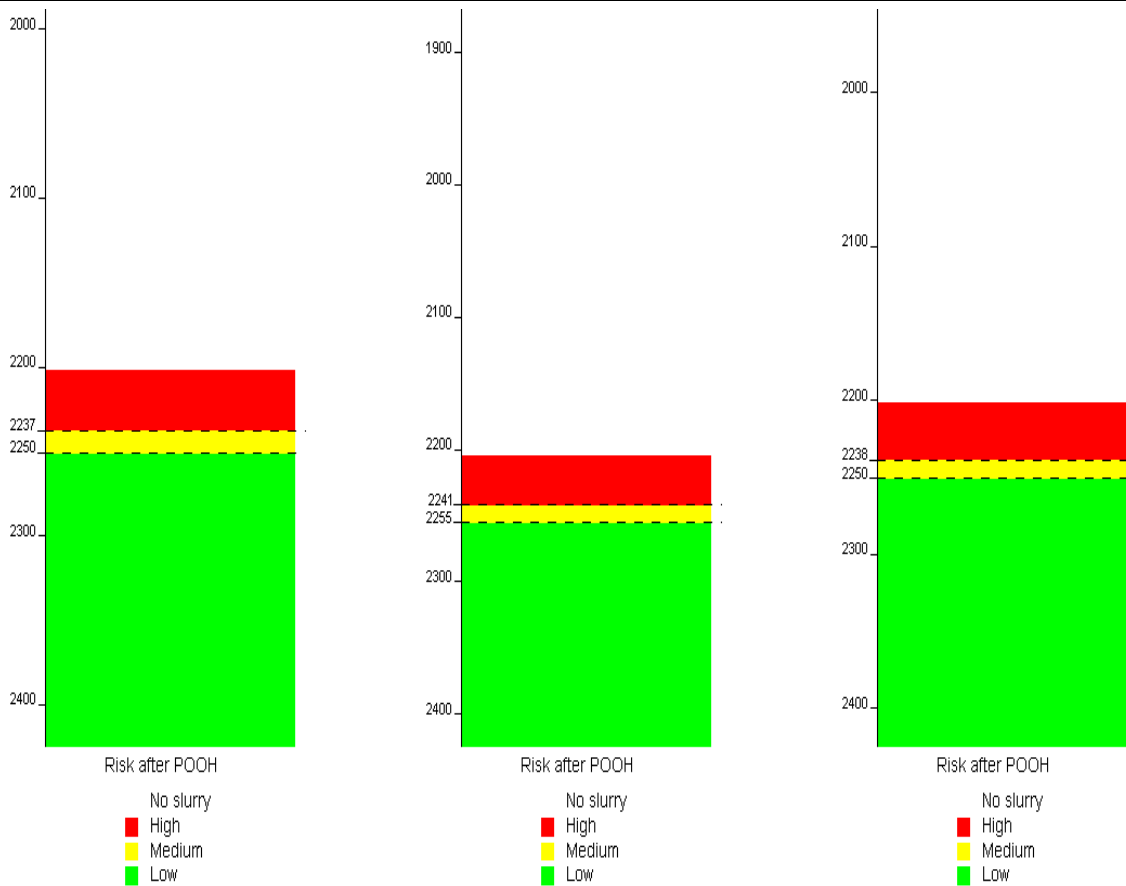

Figure B.30: POOH results case 88-90 Note : Simulation assumes that fluids are free to balance themselves

FINAL CONTAMINATION RISK (AFTER POOH) DLS: 6.0 degree / 30 meters Angle into res: 90 degrees

Table B.31: POOH results case 91-93

91. POOH Summary - Stinger size ID: 3.3inch - Stinger length: 150 meters			
Final DP depth :	2067.5 m	Theoretical Top of Plug:	2270.0 m
Theoretical Top of Plug (based on slurry volume)		2270.0 m	
Initial Top of Plug from POOH (Uncontaminated POOH Simulation)		2270.3 m	
Estimated Top of Cement after POOH (Final POOH Simulation)		2285.3 m	
92. POOH Summary - Stinger size ID: 3.8inch - Stinger length: 150 meters			
Final DP depth :	2082.5 m	Theoretical Top of Plug:	2270.0 m
Theoretical Top of Plug (based on slurry volume)		2270.0 m	
Initial Top of Plug from POOH (Uncontaminated POOH Simulation)		2270.0 m	
Estimated Top of Cement after POOH (Final POOH Simulation)		2291.3 m	
93. POOH Summary - Stinger size ID: 3.3inch - Stinger length: 300 meters			
Final DP depth :	2017.4 m	Theoretical Top of Plug:	2270.0 m
Theoretical Top of Plug (based on slurry volume)		2270.0 m	
Initial Top of Plug from POOH (Uncontaminated POOH Simulation)		2270.0 m	
Estimated Top of Cement after POOH (Final POOH Simulation)		2283.5 m	

Final Contamination Risk (from left to right: 91,92,93)

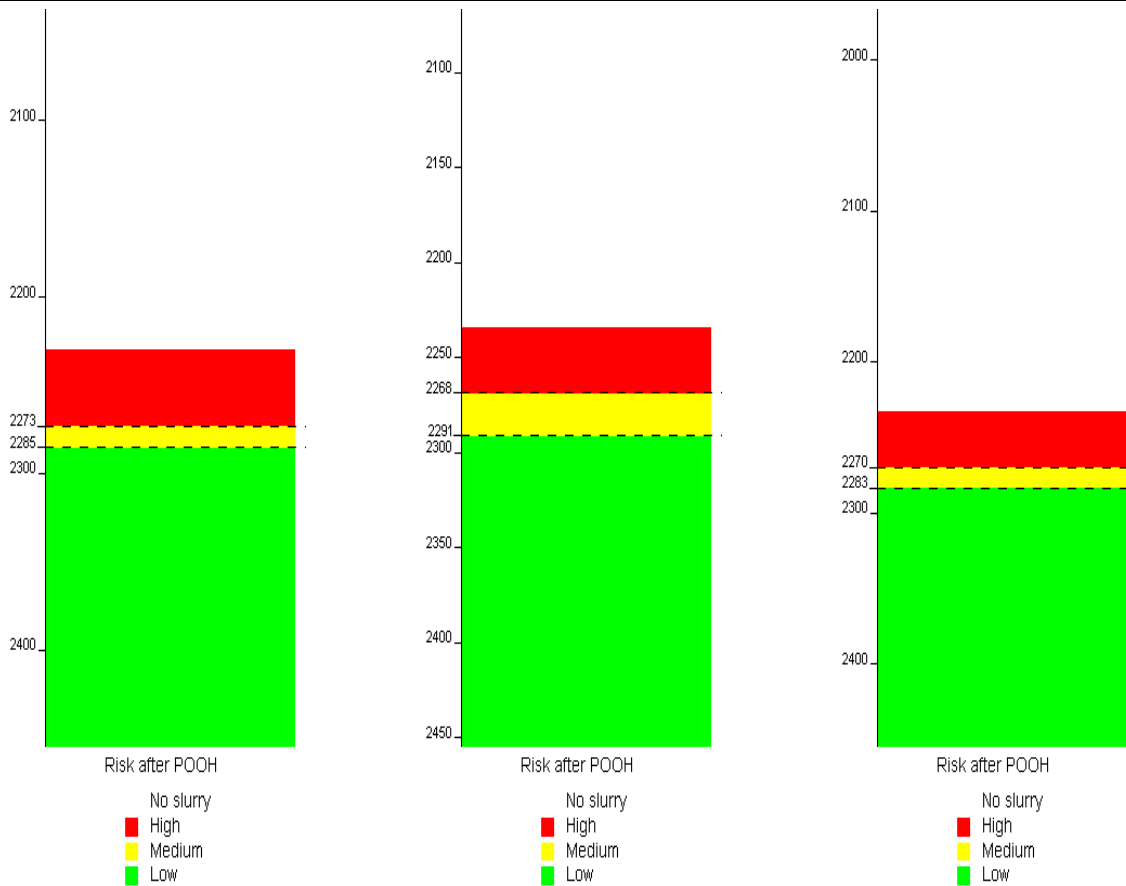

Figure B.31: POOH results case 91-93 Note : Simulation assumes that fluids are free to balance themselves

FINAL CONTAMINATION RISK (AFTER POOH) DLS: 6.0 degree / 30 meters Angle into res: 90 degrees

Table B.32: POOH results case 94-96

94. POOH Summary - Stinger size ID: 3.8inch - Stinger length: 300 meters			
Final DP depth :	2046.2 m	Theoretical Top of Plug:	2270.0 m
Theoretical Top of Plug (based on slurry volume)		2270.0 m	
Initial Top of Plug from POOH (Uncontaminated POOH Simulation)		2270.0 m	
Estimated Top of Cement after POOH (Final POOH Simulation)		2289.7 m	
95. POOH Summary - Stinger size ID: 3.3inch - Stinger length: 450 meters			
Final DP depth :	1959.7 m	Theoretical Top of Plug:	2270.0 m
Theoretical Top of Plug (based on slurry volume)		2270.0 m	
Initial Top of Plug from POOH (Uncontaminated POOH Simulation)		2270.0 m	
Estimated Top of Cement after POOH (Final POOH Simulation)		2283.9 m	
96. POOH Summary - Stinger size ID: 3.8inch - Stinger length: 450 meters			
Final DP depth :	2027.0 m	Theoretical Top of Plug:	2270.0 m
Theoretical Top of Plug (based on slurry volume)		2270.0 m	
Initial Top of Plug from POOH (Uncontaminated POOH Simulation)		2270.0 m	
Estimated Top of Cement after POOH (Final POOH Simulation)		2289.8 m	

Final Contamination Risk (from right to left: 94,95,96)

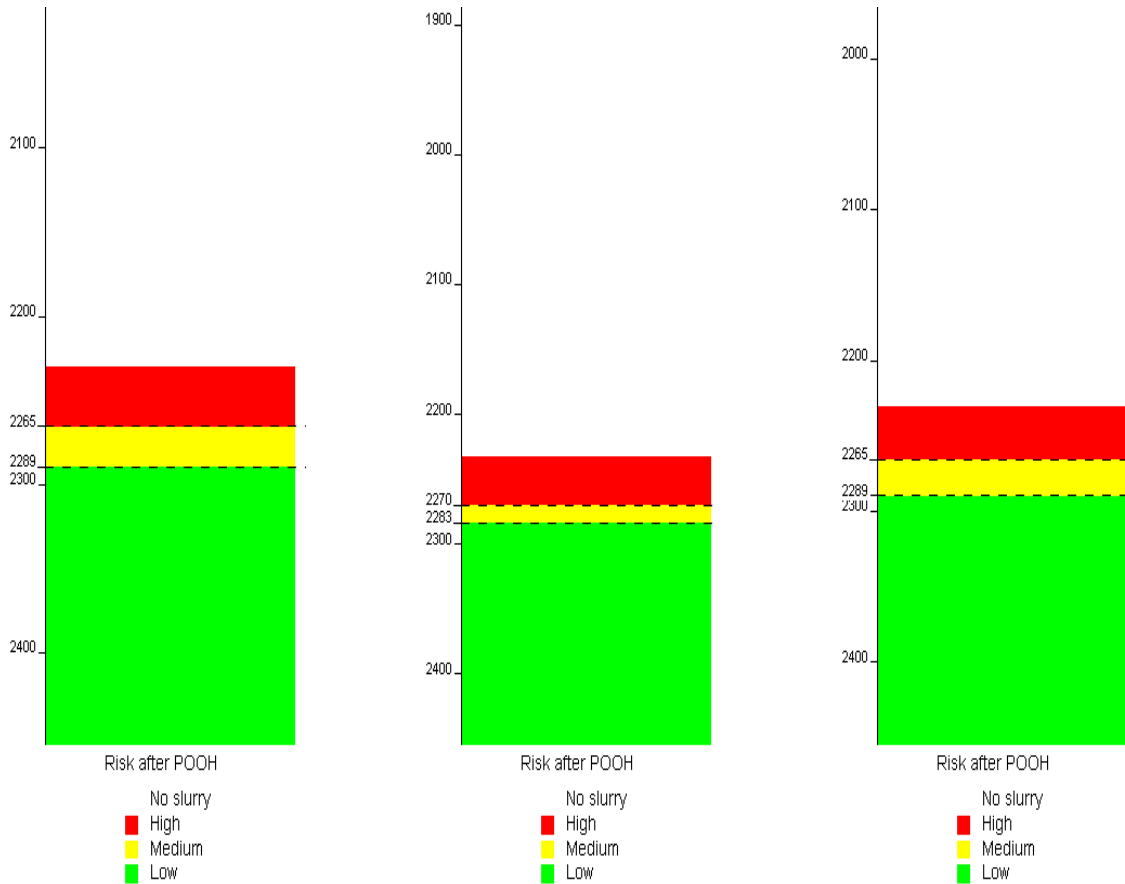

Figure B.32: POOH results case 94-96 Note : Simulation assumes that fluids are free to balance themselves

FINAL CONTAMINATION RISK (AFTER POOH) DLS: 7.8 degree / 30 meters Angle into res: 60 degrees

Table B.33: POOH results case 97-99

97. POOH Summary - Stinger size ID: 3.3inch - Stinger length: 150 meters			
Final DP depth :	2009.4 m	Theoretical Top of Plug:	2210.0 m
Theoretical Top of Plug (based on slurry volume)		2210.0 m	
Initial Top of Plug from POOH (Uncontaminated POOH Simulation)		2210.4 m	
Estimated Top of Cement after POOH (Final POOH Simulation)		2228.4 m	
98. POOH Summary - Stinger size ID: 3.8inch - Stinger length: 150 meters			
Final DP depth :	2023.7 m	Theoretical Top of Plug:	2210.0 m
Theoretical Top of Plug (based on slurry volume)		2210.0 m	
Initial Top of Plug from POOH (Uncontaminated POOH Simulation)		2210.0 m	
Estimated Top of Cement after POOH (Final POOH Simulation)		2223.6 m	
99. POOH Summary - Stinger size ID: 3.3inch - Stinger length: 300 meters			
Final DP depth :	1959.7 m	Theoretical Top of Plug:	2210.0 m
Theoretical Top of Plug (based on slurry volume)		2210.0 m	
Initial Top of Plug from POOH (Uncontaminated POOH Simulation)		2210.0 m	
Estimated Top of Cement after POOH (Final POOH Simulation)		2226.9 m	

Final Contamination Risk (from left to right: 97,98,99)

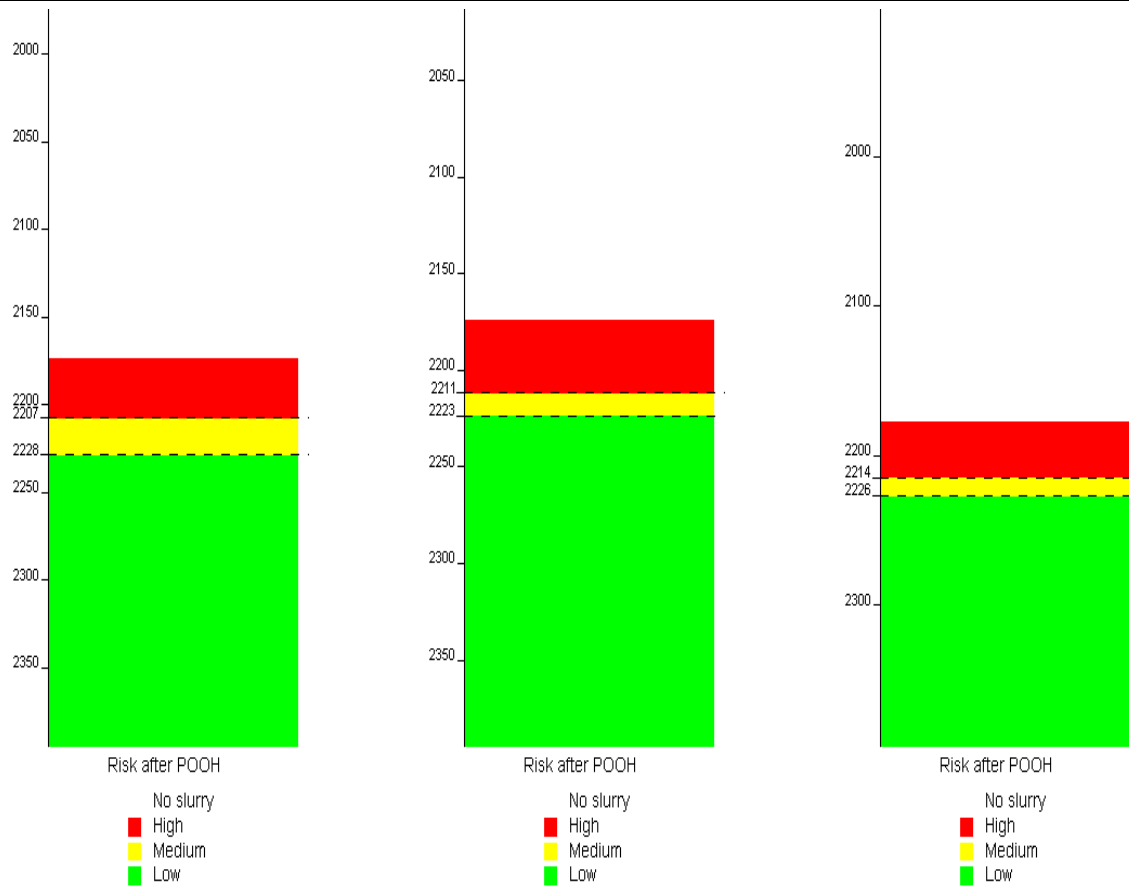

Figure B.33: POOH results case 97-99 Note : Simulation assumes that fluids are free to balance themselves

FINAL CONTAMINATION RISK (AFTER POOH) DLS: 7.8 degree / 30 meters Angle into res: 60 degrees

Table B.34: POOH results case 100-102

100. POOH Summary - Stinger size ID: 3.8inch - Stinger length: 300 meters			
Final DP depth :	1987.9 m	Theoretical Top of Plug:	2210.0 m
Theoretical Top of Plug (based on slurry volume)		2210.0 m	
Initial Top of Plug from POOH (Uncontaminated POOH Simulation)		2210.0 m	
Estimated Top of Cement after POOH (Final POOH Simulation)		2222.2 m	
101. POOH Summary - Stinger size ID: 3.3inch - Stinger length: 450 meters			
Final DP depth :	1903.5 m	Theoretical Top of Plug:	2210.0 m
Theoretical Top of Plug (based on slurry volume)		2210.0 m	
Initial Top of Plug from POOH (Uncontaminated POOH Simulation)		2210.1 m	
Estimated Top of Cement after POOH (Final POOH Simulation)		2226.7 m	
102. POOH Summary - Stinger size ID: 3.8inch - Stinger length: 450 meters			
Final DP depth :	1969.3 m	Theoretical Top of Plug:	2210.0 m
Theoretical Top of Plug (based on slurry volume)		2210.0 m	
Initial Top of Plug from POOH (Uncontaminated POOH Simulation)		2210.0 m	
Estimated Top of Cement after POOH (Final POOH Simulation)		2222.0 m	

Final Contamination Risk (from left to right: 100,101,102)

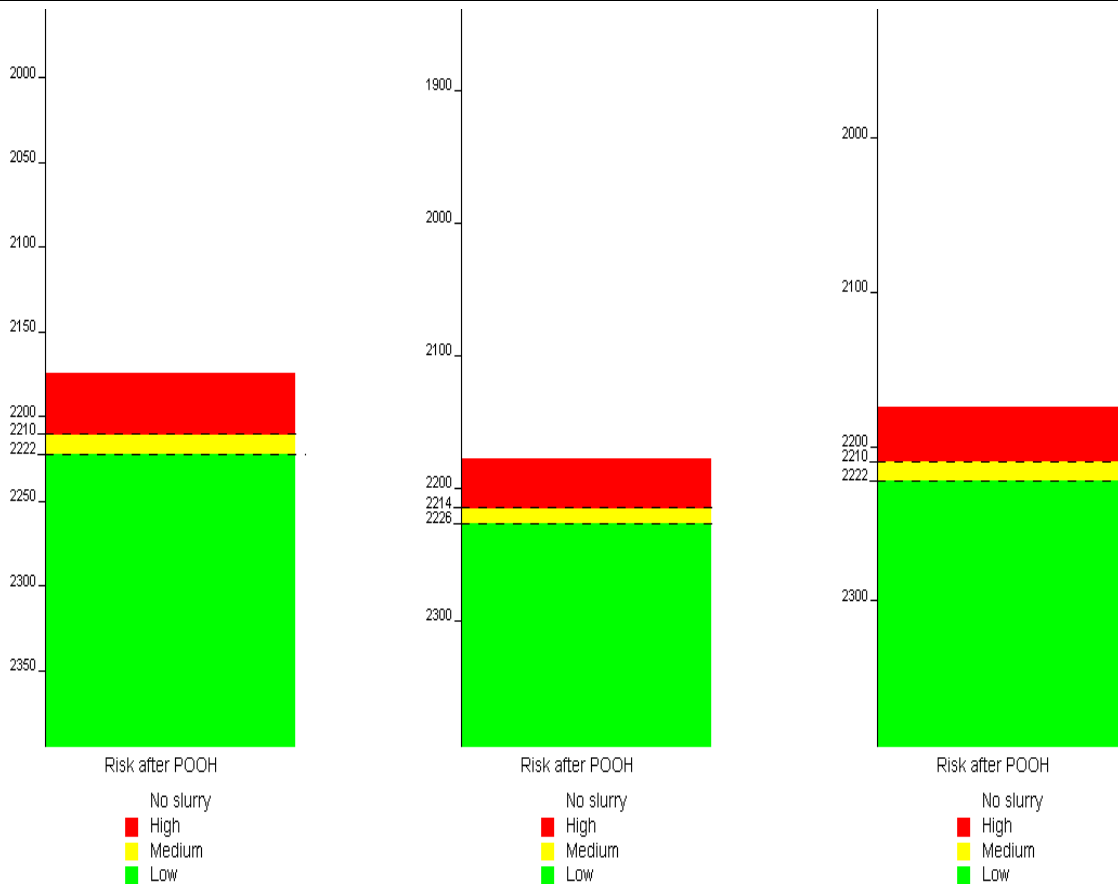

Figure B.34: POOH results case 100-102

Note : Simulation assumes that fluids are free to balance themselves

FINAL CONTAMINATION RISK (AFTER POOH) DLS: 7.8 degree / 30 meters Angle into res: 70 degrees

Table B.35: POOH results case 103-105

103. POOH Summary - Stinger size ID: 3.3inch - Stinger length: 150 meters			
Final DP depth :	2014.3 m	Theoretical Top of Plug:	2215.0 m
Theoretical Top of Plug (based on slurry volume)			2215.0 m
Initial Top of Plug from POOH (Uncontaminated POOH Simulation)			2215.4 m
Estimated Top of Cement after POOH (Final POOH Simulation)			2233.4 m
104. POOH Summary - Stinger size ID: 3.8inch - Stinger length: 150 meters			
Final DP depth :	1974.2 m	Theoretical Top of Plug:	2215.0 m
Theoretical Top of Plug (based on slurry volume)			2215.0 m
Initial Top of Plug from POOH (Uncontaminated POOH Simulation)			2215.0 m
Estimated Top of Cement after POOH (Final POOH Simulation)			2227.0 m
105. POOH Summary - Stinger size ID: 3.3inch - Stinger length: 300 meters			
Final DP depth :	1964.7 m	Theoretical Top of Plug:	2215.0 m
Theoretical Top of Plug (based on slurry volume)			2215.0 m
Initial Top of Plug from POOH (Uncontaminated POOH Simulation)			2215.0 m
Estimated Top of Cement after POOH (Final POOH Simulation)			2231.9 m

Final Contamination Risk (from left to right: 103,104,105)

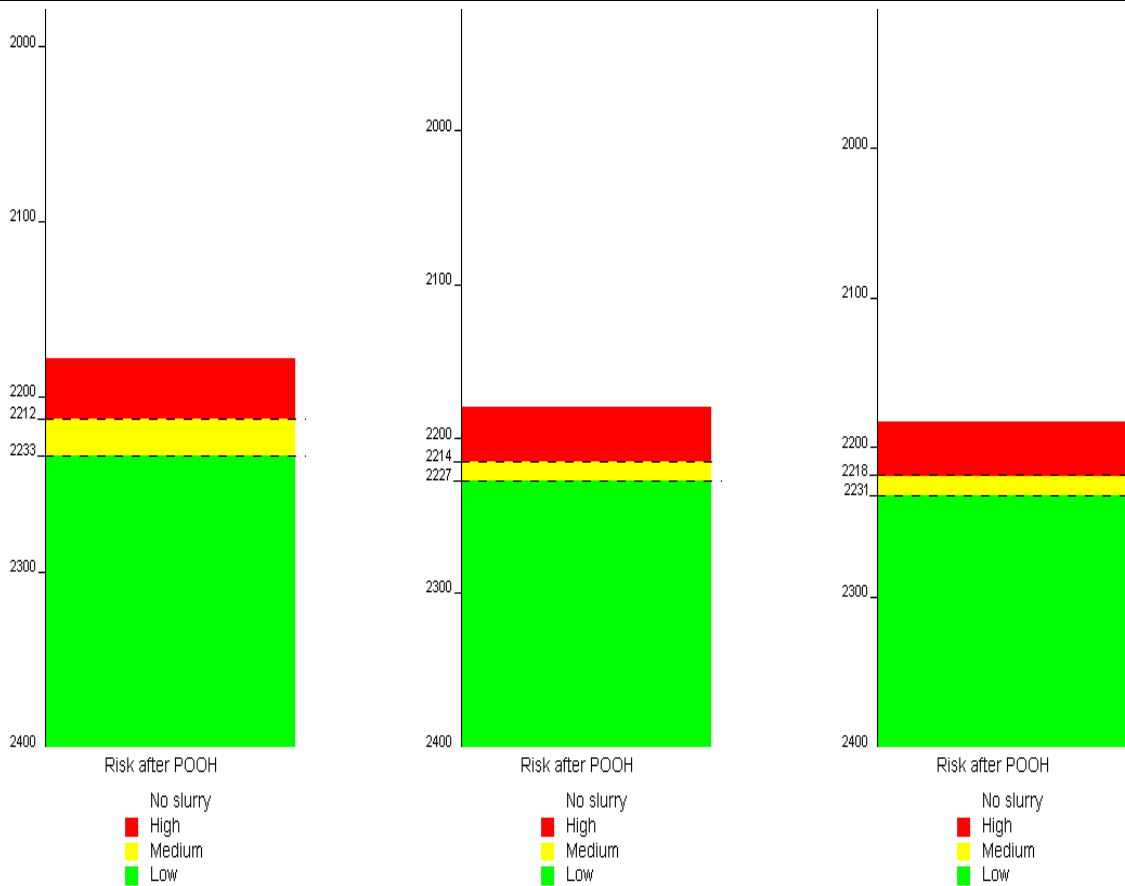

Figure B.35: POOH results case 103-105 Note : Simulation assumes that fluids are free to balance themselves

FINAL CONTAMINATION RISK (AFTER POOH) DLS: 7.8 degree / 30 meters Angle into res: 70 degrees

Table B.36: POOH results case 106-108

106. POOH Summary - Stinger size ID: 3.8inch - Stinger length: 300 meters			
Final DP depth :	1992.8 m	Theoretical Top of Plug:	2215.0 m
Theoretical Top of Plug (based on slurry volume)			2215.0 m
Initial Top of Plug from POOH (Uncontaminated POOH Simulation)			2215.0 m
Estimated Top of Cement after POOH (Final POOH Simulation)			2227.2 m
107. POOH Summary - Stinger size ID: 3.3inch - Stinger length: 450 meters			
Final DP depth :	1908.5 m	Theoretical Top of Plug:	2215.0 m
Theoretical Top of Plug (based on slurry volume)			2215.0 m
Initial Top of Plug from POOH (Uncontaminated POOH Simulation)			2215.1 m
Estimated Top of Cement after POOH (Final POOH Simulation)			2231.6 m
108. POOH Summary - Stinger size ID: 3.8inch - Stinger length: 450 meters			
Final DP depth :	1974.2 m	Theoretical Top of Plug:	2215.0 m
Theoretical Top of Plug (based on slurry volume)			2215.0 m
Initial Top of Plug from POOH (Uncontaminated POOH Simulation)			2215.0 m
Estimated Top of Cement after POOH (Final POOH Simulation)			2227.0 m

Final Contamination Risk (from left to right: 106,107,108)

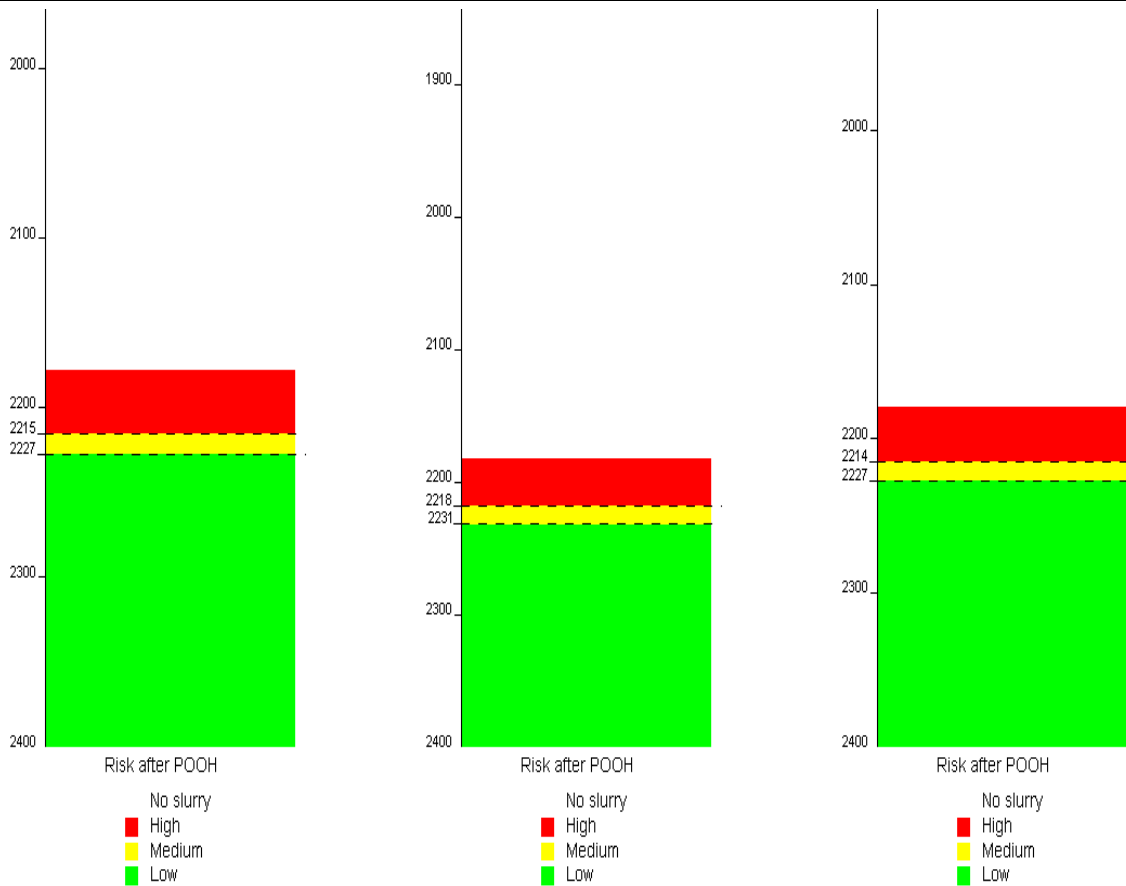

Figure B.36: POOH results case 106-108

Note : Simulation assumes that fluids are free to balance themselves

FINAL CONTAMINATION RISK (AFTER POOH) DLS: 7.8 degree / 30 meters Angle into res: 80 degrees

Table B.37: POOH results case 109-111

109. POOH Summary - Stinger size ID: 3.3inch - Stinger length: 150 meters			
Final DP depth :	2014.3 m	Theoretical Top of Plug:	2215.0 m
Theoretical Top of Plug (based on slurry volume)		2215.0 m	
Initial Top of Plug from POOH (Uncontaminated POOH Simulation)		2215.4 m	
Estimated Top of Cement after POOH (Final POOH Simulation)		2233.4 m	
110. POOH Summary - Stinger size ID: 3.8inch - Stinger length: 150 meters			
Final DP depth :	2028.7 m	Theoretical Top of Plug:	2215.0 m
Theoretical Top of Plug (based on slurry volume)		2215.0 m	
Initial Top of Plug from POOH (Uncontaminated POOH Simulation)		2215.0 m	
Estimated Top of Cement after POOH (Final POOH Simulation)		2228.6 m	
111. POOH Summary - Stinger size ID: 3.3inch - Stinger length: 300 meters			
Final DP depth :	1964.7 m	Theoretical Top of Plug:	2215.0 m
Theoretical Top of Plug (based on slurry volume)		2215.0 m	
Initial Top of Plug from POOH (Uncontaminated POOH Simulation)		2215.0 m	
Estimated Top of Cement after POOH (Final POOH Simulation)		2231.9 m	

Final Contamination Risk (from left to right: 109,110,111)

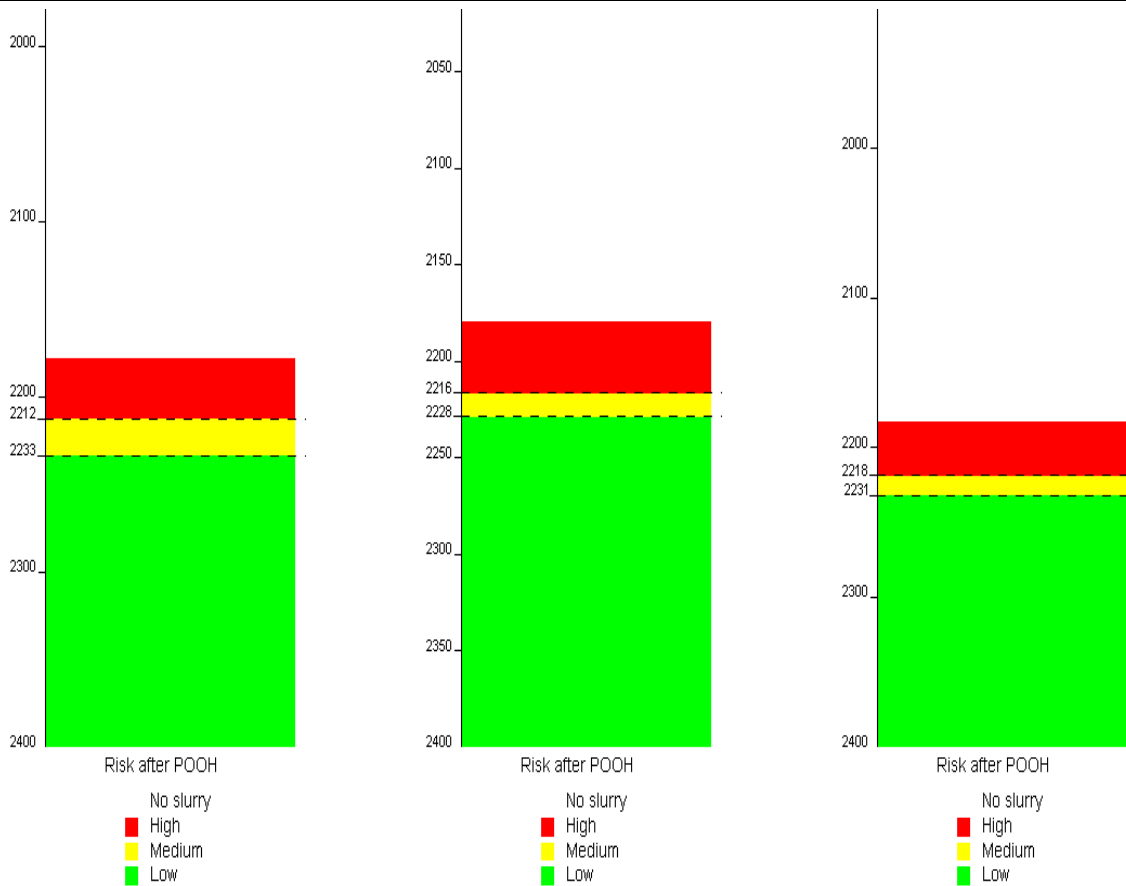

Figure B.37: POOH results case 109-111

Note : Simulation assumes that fluids are free to balance themselves

FINAL CONTAMINATION RISK (AFTER POOH) DLS: 7.8 degree / 30 meters Angle into res: 80 degrees

Table B.38: POOH results case 112-114

112. POOH Summary - Stinger size ID: 3.8inch - Stinger length: 300 meters			
Final DP depth :	1992.8 m	Theoretical Top of Plug:	2215.0 m
Theoretical Top of Plug (based on slurry volume)			2215.0 m
Initial Top of Plug from POOH (Uncontaminated POOH Simulation)			2215.0 m
Estimated Top of Cement after POOH (Final POOH Simulation)			2227.2 m
113. POOH Summary - Stinger size ID: 3.3inch - Stinger length: 450 meters			
Final DP depth :	1908.5 m	Theoretical Top of Plug:	2215.0 m
Theoretical Top of Plug (based on slurry volume)			2215.0 m
Initial Top of Plug from POOH (Uncontaminated POOH Simulation)			2215.1 m
Estimated Top of Cement after POOH (Final POOH Simulation)			2231.6 m
114. POOH Summary - Stinger size ID: 3.8inch - Stinger length: 450 meters			
Final DP depth :	1974.2 m	Theoretical Top of Plug:	2215.0 m
Theoretical Top of Plug (based on slurry volume)			2215.0 m
Initial Top of Plug from POOH (Uncontaminated POOH Simulation)			2215.0 m
Estimated Top of Cement after POOH (Final POOH Simulation)			2227.0 m

Final Contamination Risk (from left to right: 112,113,114)

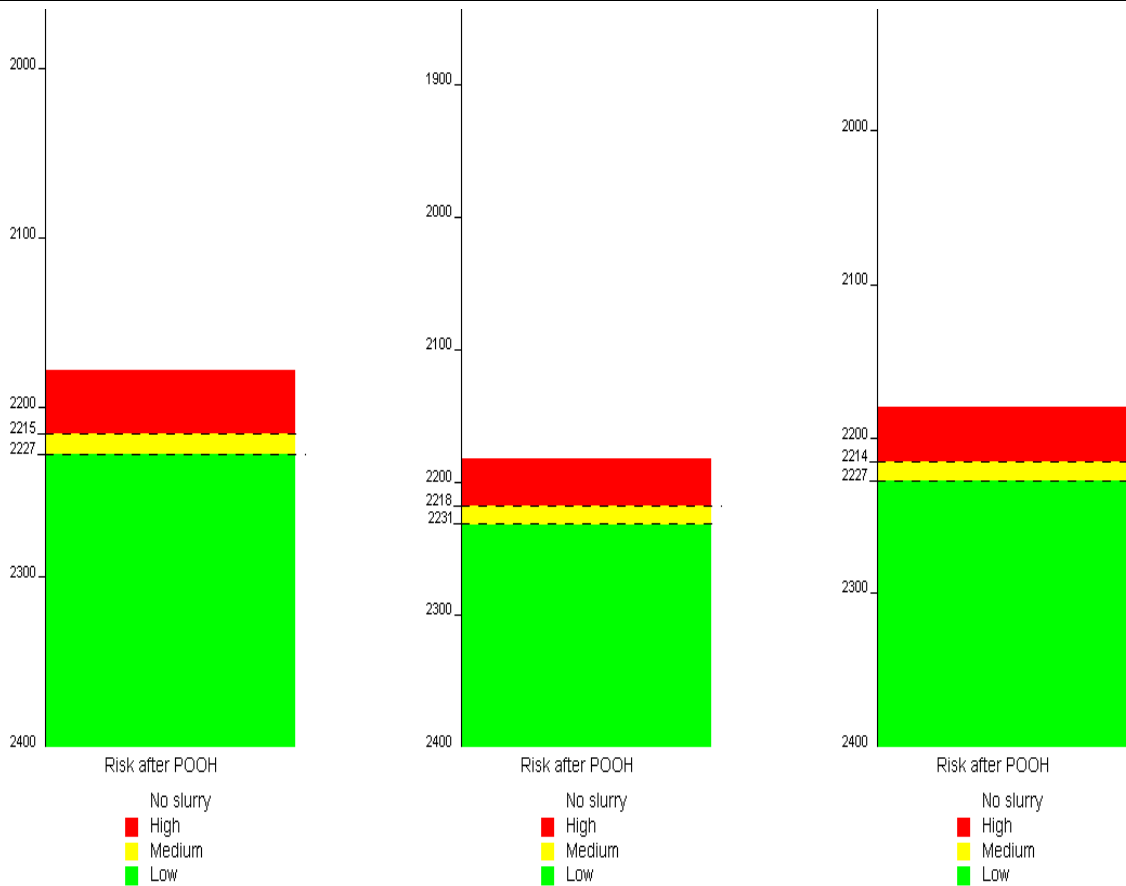

Figure B.38: POOH results case 112-114

Note : Simulation assumes that fluids are free to balance themselves

FINAL CONTAMINATION RISK (AFTER POOH) DLS: 7.8 degree / 30 meters Angle into res: 90 degrees

Table B.39: POOH results case 115-117

115. POOH Summary - Stinger size ID: 3.3inch - Stinger length: 150 meters			
Final DP depth :	2014.3 m	Theoretical Top of Plug:	2215.0 m
Theoretical Top of Plug (based on slurry volume)		2215.0 m	
Initial Top of Plug from POOH (Uncontaminated POOH Simulation)		2215.4 m	
Estimated Top of Cement after POOH (Final POOH Simulation)		2233.4 m	
116. POOH Summary - Stinger size ID: 3.8inch - Stinger length: 150 meters			
Final DP depth :	2028.7 m	Theoretical Top of Plug:	2215.0 m
Theoretical Top of Plug (based on slurry volume)		2215.0 m	
Initial Top of Plug from POOH (Uncontaminated POOH Simulation)		2215.0 m	
Estimated Top of Cement after POOH (Final POOH Simulation)		2228.6 m	
117. POOH Summary - Stinger size ID: 3.3inch - Stinger length: 300 meters			
Final DP depth :	1964.7 m	Theoretical Top of Plug:	2215.0 m
Theoretical Top of Plug (based on slurry volume)		2215.0 m	
Initial Top of Plug from POOH (Uncontaminated POOH Simulation)		2215.0 m	
Estimated Top of Cement after POOH (Final POOH Simulation)		2231.9 m	

Final Contamination Risk (from left to right: 115,116,117)

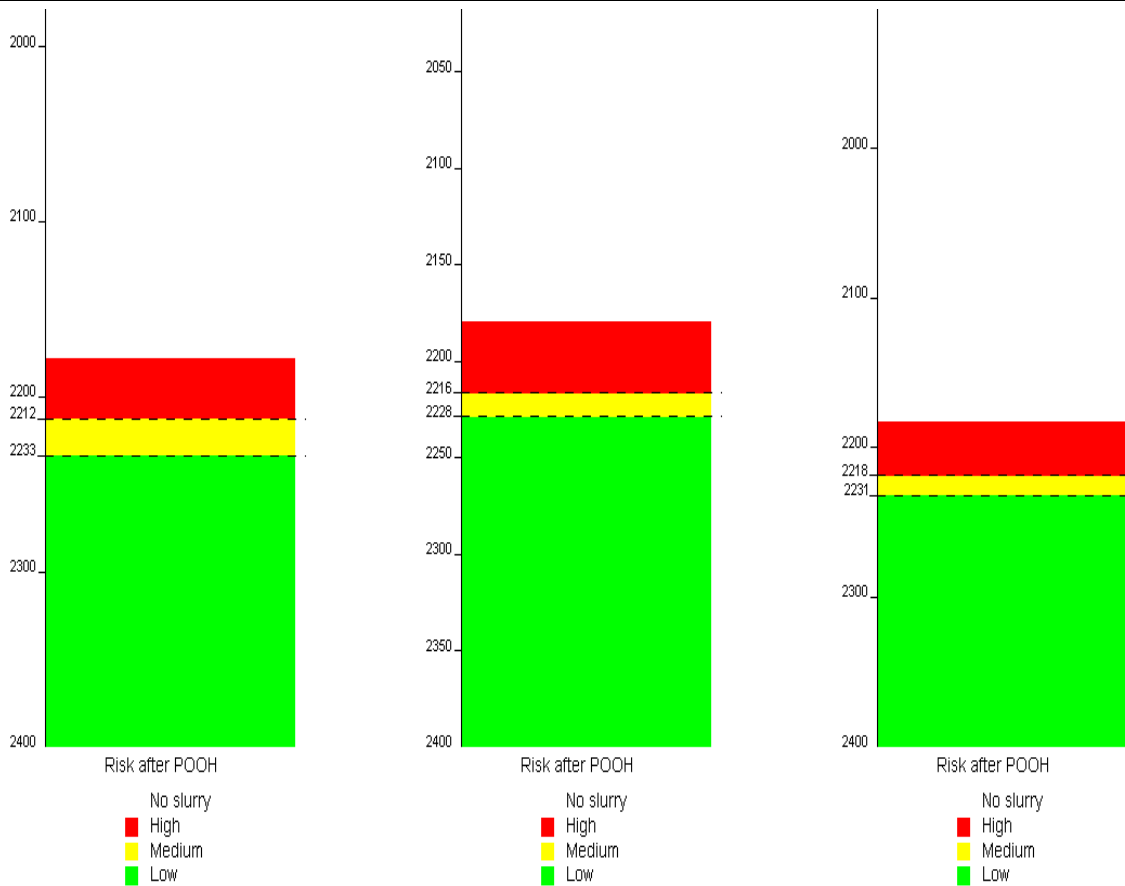

Figure B.39: POOH results case 115-117

Note : Simulation assumes that fluids are free to balance themselves

FINAL CONTAMINATION RISK (AFTER POOH) DLS: 7.8 degree / 30 meters Angle into res: 90 degrees

Table B.40: POOH results case 118-120

118. POOH Summary - Stinger size ID: 3.8inch - Stinger length: 300 meters			
Final DP depth :	1974.2 m	Theoretical Top of Plug:	2215.0 m
Theoretical Top of Plug (based on slurry volume)		2215.0 m	
Initial Top of Plug from POOH (Uncontaminated POOH Simulation)		2219.4 m	
Estimated Top of Cement after POOH (Final POOH Simulation)		2227.0 m	
119. POOH Summary - Stinger size ID: 3.3inch - Stinger length: 450 meters			
Final DP depth :	1908.5 m	Theoretical Top of Plug:	2215.0 m
Theoretical Top of Plug (based on slurry volume)		2215.0 m	
Initial Top of Plug from POOH (Uncontaminated POOH Simulation)		2215.1 m	
Estimated Top of Cement after POOH (Final POOH Simulation)		2231.6 m	
120. POOH Summary - Stinger size ID: 3.8inch - Stinger length: 450 meters			
Final DP depth :	1974.2 m	Theoretical Top of Plug:	2215.0 m
Theoretical Top of Plug (based on slurry volume)		2215.0 m	
Initial Top of Plug from POOH (Uncontaminated POOH Simulation)		2215.0 m	
Estimated Top of Cement after POOH (Final POOH Simulation)		2227.0 m	

Final Contamination Risk (from left to right: 118,119,120)

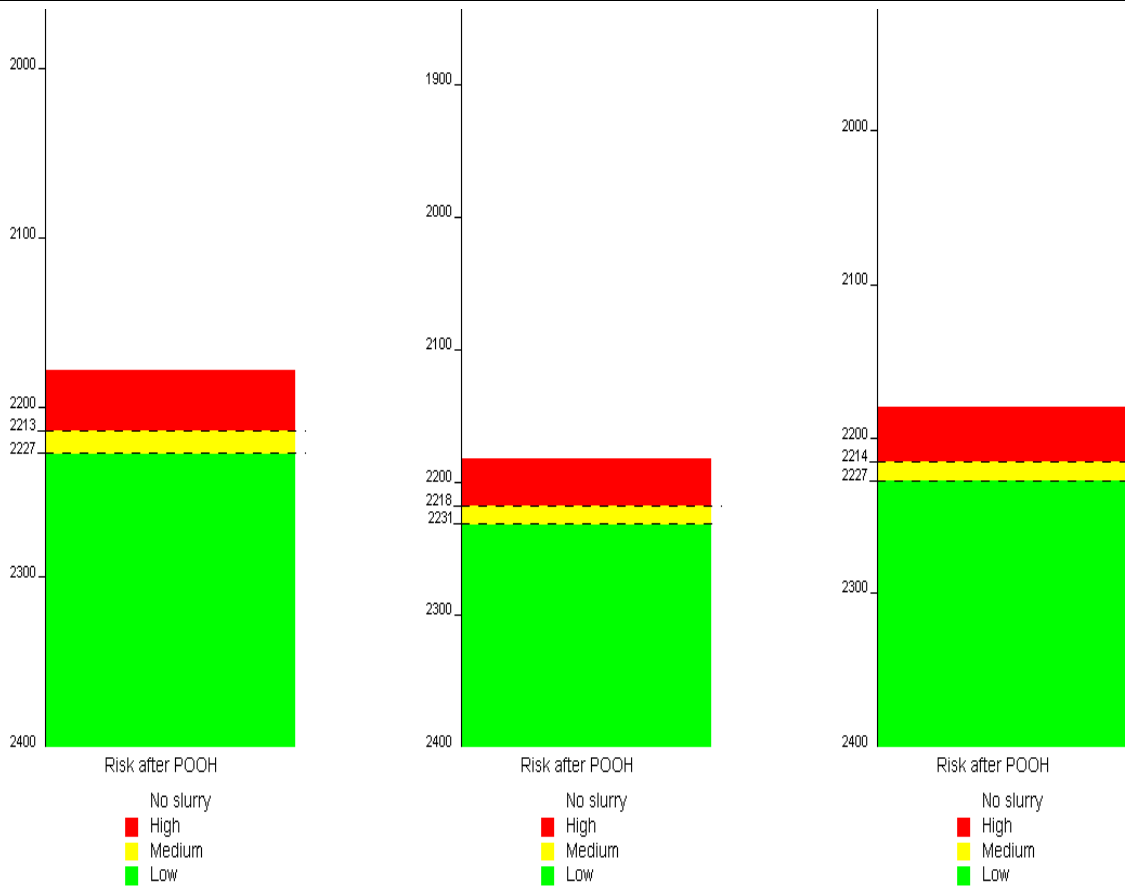

Figure B.40: POOH results case 118-120

Note : Simulation assumes that fluids are free to balance themselves

Appendix C

This appendix contains all the final POOH results from the two plug method. The figures and tables are marked with DLS, inclination angle, stinger size and length. The dimensions on the graphs might not match each other as the simulation gives out different proportions on graphs for different cases. However, the numbers and values in tables and figures are comparable. All the tables and figures are taken from reports generated in the software “Cementics zonal isolation”.

FINAL CONTAMINATION RISK (AFTER POOH) DLS: 1.8 degree / 30 meters. Two plug method

Table C.1: POOH results case 1-2

1. POOH Summary – Angle into reservoir: 60 degrees			
Final DP depth :	2208.0 m	Theoretical Top of Plug:	2440.0 m
Theoretical Top of Plug (based on slurry volume)			2440.0 m
Initial Top of Plug from POOH (Uncontaminated POOH Simulation)			2440.0 m
Estimated Top of Cement after POOH (Final POOH Simulation)			2450.4 m
2. POOH Summary – Angle into reservoir: 90 degrees			
Final DP depth :	2315.2 m	Theoretical Top of Plug:	2550.0 m
Theoretical Top of Plug (based on slurry volume)			2550.0 m
Initial Top of Plug from POOH (Uncontaminated POOH Simulation)			2550.0 m
Estimated Top of Cement after POOH (Final POOH Simulation)			2566.5 m

Final Contamination Risk (from left to right: 1,2)

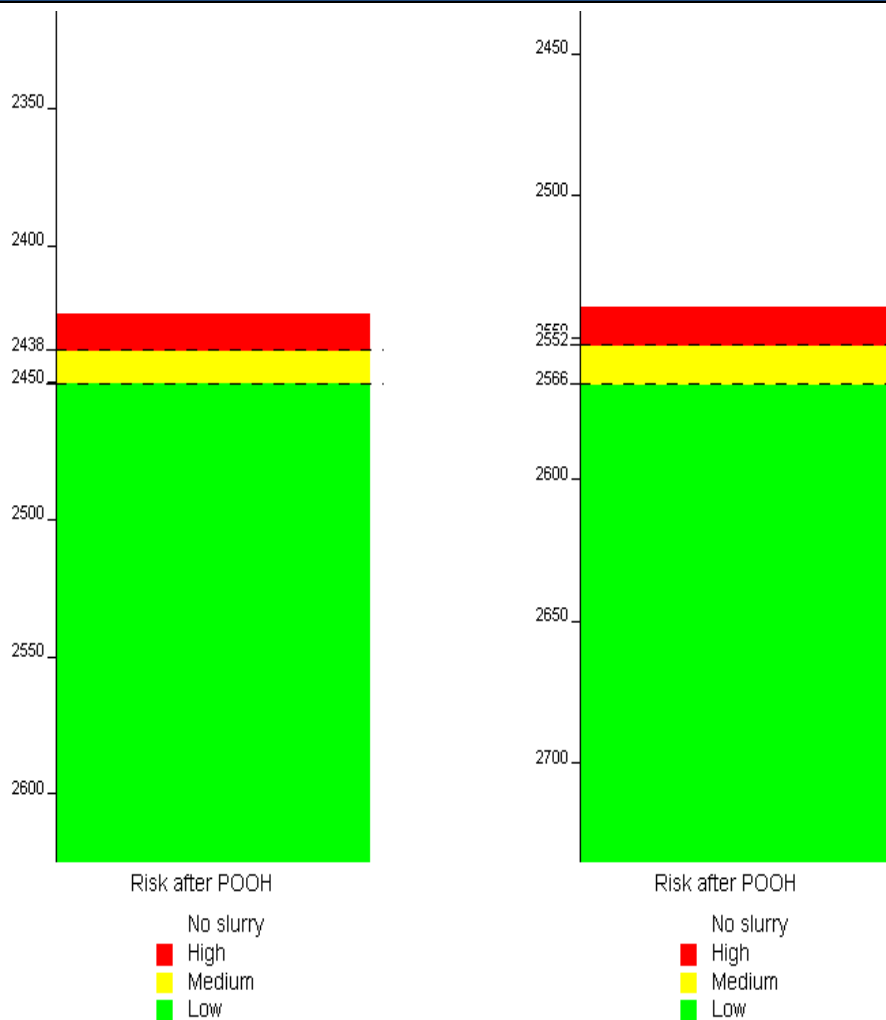

Figure C.1: POOH results case 1-2

Note : Simulation assumes that fluids are free to balance themselves

FINAL CONTAMINATION RISK (AFTER POOH) DLS: 3.0 degree / 30 meters. Two plug method

Table C.2: POOH results case 3-4

3. POOH Summary – Angle into reservoir: 60 degrees			
Final DP depth :	2096.6 m	Theoretical Top of Plug:	2325.0 m
Theoretical Top of Plug (based on slurry volume)		2325.0 m	
Initial Top of Plug from POOH (Uncontaminated POOH Simulation)		2325.0 m	
Estimated Top of Cement after POOH (Final POOH Simulation)		2331.1 m	
4. POOH Summary – Angle into reservoir: 90 degrees			
Final DP depth :	2145.1 m	Theoretical Top of Plug:	2375.0 m
Theoretical Top of Plug (based on slurry volume)		2375.0 m	
Initial Top of Plug from POOH (Uncontaminated POOH Simulation)		2375.0 m	
Estimated Top of Cement after POOH (Final POOH Simulation)		2390.1 m	

Final Contamination Risk (from left to right: 3,4)

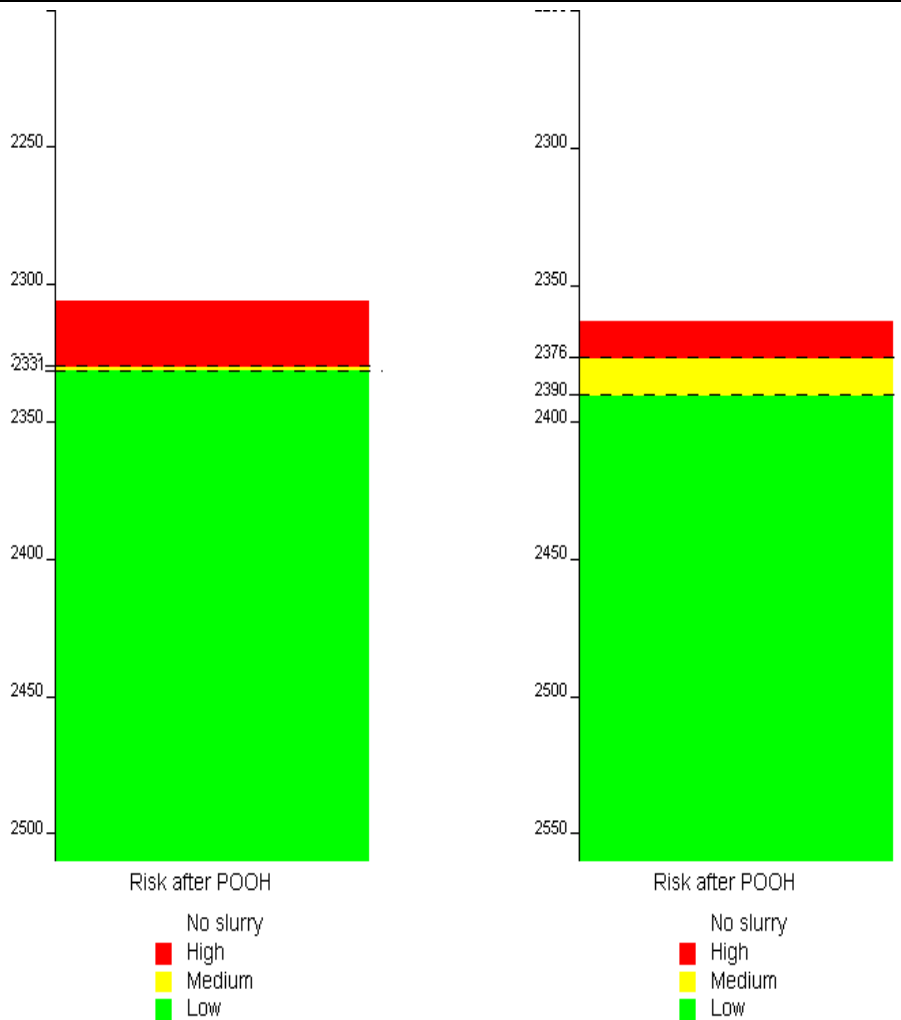

Figure C.2: POOH results case 3-4

Note : Simulation assumes that fluids are free to balance themselves

FINAL CONTAMINATION RISK (AFTER POOH) DLS: 4.2 degree / 30 meters. Two plug method

Table C.3: POOH results case 5-6

5. POOH Summary – Angle into reservoir: 60 degrees			
Final DP depth :	2044.6 m	Theoretical Top of Plug:	2270.0 m
Theoretical Top of Plug (based on slurry volume)			2270.0 m
Initial Top of Plug from POOH (Uncontaminated POOH Simulation)			2270.0 m
Estimated Top of Cement after POOH (Final POOH Simulation)			2279.1 m
6. POOH Summary – Angle into reservoir: 90 degrees			
Final DP depth :	2068.8 m	Theoretical Top of Plug:	2295.0 m
Theoretical Top of Plug (based on slurry volume)			2295.0 m
Initial Top of Plug from POOH (Uncontaminated POOH Simulation)			2295.0 m
Estimated Top of Cement after POOH (Final POOH Simulation)			2302.9 m

Final Contamination Risk (from left to right: 5,6)

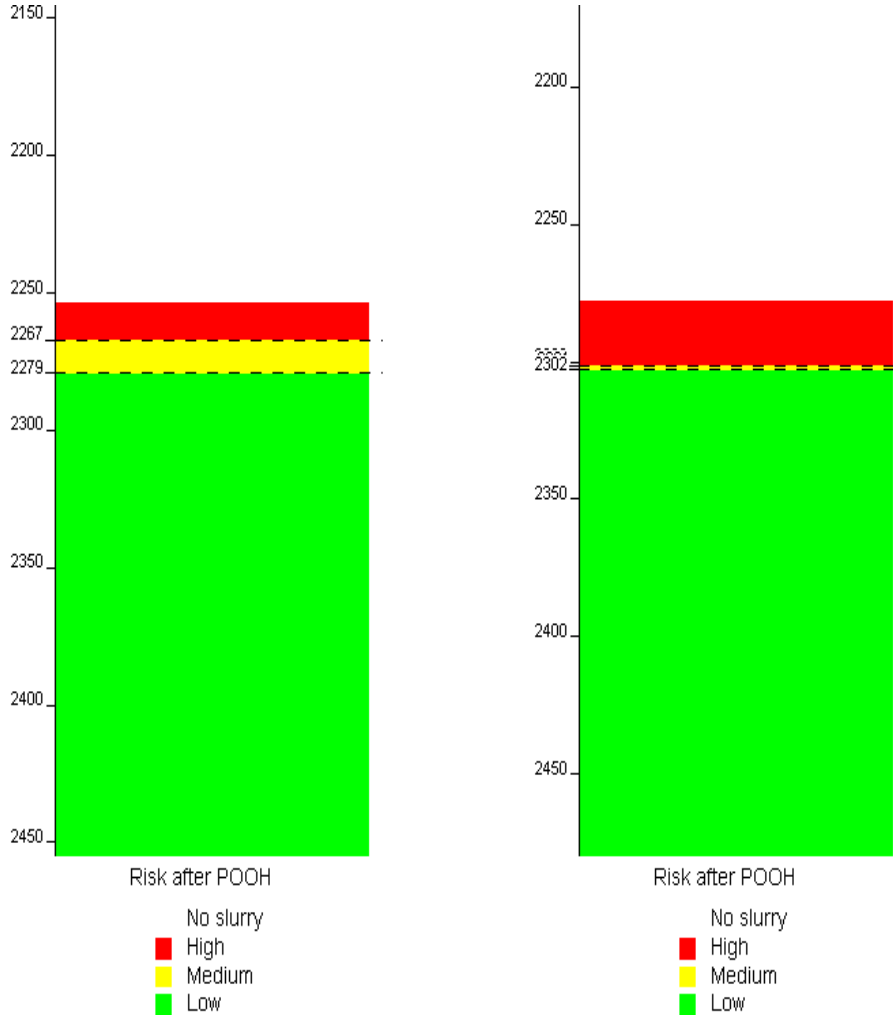

Figure C.3: POOH results case 5-6 Note : Simulation assumes that fluids are free to balance themselves

FINAL CONTAMINATION RISK (AFTER POOH) DLS: 6.0 degree / 30 meters. Two plug method

Table C.4: POOH results case 7-8

7. POOH Summary – Angle into reservoir: 60 degrees			
Final DP depth :	2011.9 m	Theoretical Top of Plug:	2235.0 m
Theoretical Top of Plug (based on slurry volume)			2235.0 m
Initial Top of Plug from POOH (Uncontaminated POOH Simulation)			2235.0 m
Estimated Top of Cement after POOH (Final POOH Simulation)			2245.9 m
8. POOH Summary – Angle into reservoir: 90 degrees			
Final DP depth :	2026.5 m	Theoretical Top of Plug:	2250.0 m
Theoretical Top of Plug (based on slurry volume)			2250.0 m
Initial Top of Plug from POOH (Uncontaminated POOH Simulation)			2250.0 m
Estimated Top of Cement after POOH (Final POOH Simulation)			2260.8 m

Final Contamination Risk (from left to right: 7,8)

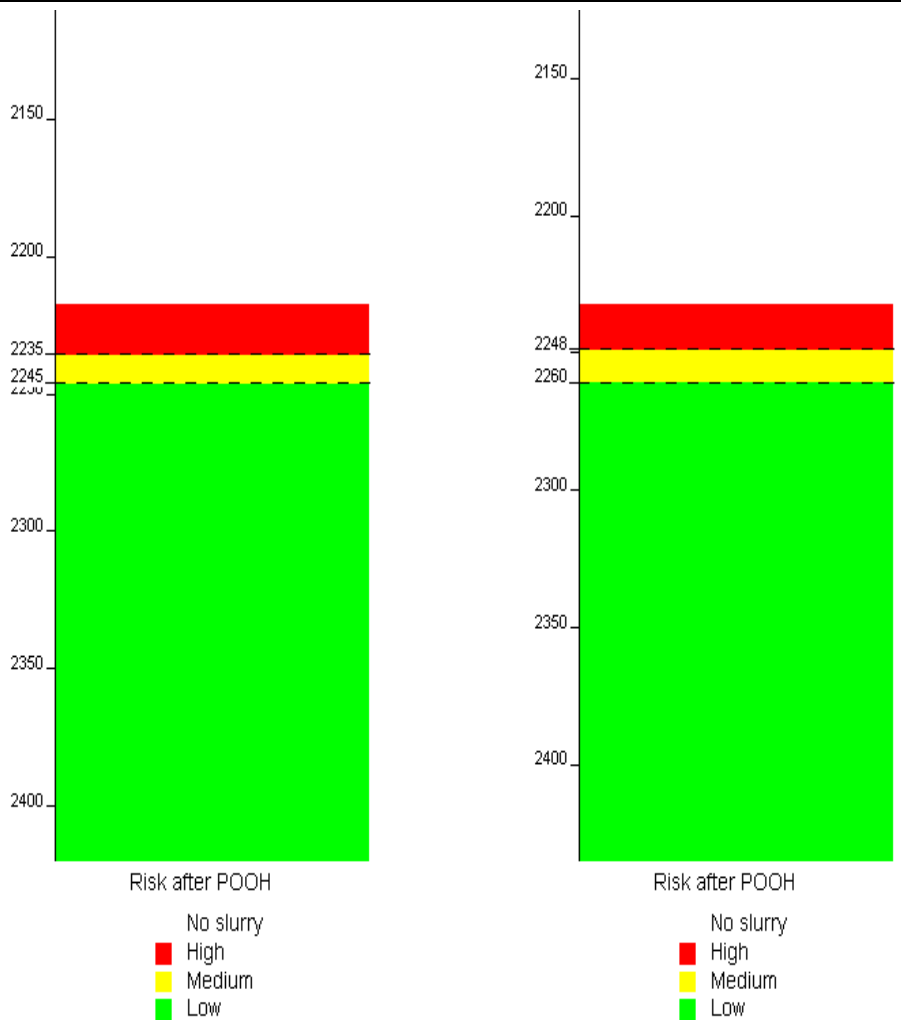

Figure C.4: POOH results case 7-8

Note : Simulation assumes that fluids are free to balance themselves

FINAL CONTAMINATION RISK (AFTER POOH) DLS: 7.8 degree / 30 meters. Two plug method

Table C.5: POOH results case 9-10

9. POOH Summary – Angle into reservoir: 60 degrees			
Final DP depth :	1987.9 m	Theoretical Top of Plug:	2210.0 m
Theoretical Top of Plug (based on slurry volume)			2210.0 m
Initial Top of Plug from POOH (Uncontaminated POOH Simulation)			2210.0 m
Estimated Top of Cement after POOH (Final POOH Simulation)			2222.2 m
10. POOH Summary – Angle into reservoir: 90 degrees			
Final DP depth :	1992.8 m	Theoretical Top of Plug:	2215.0 m
Theoretical Top of Plug (based on slurry volume)			2215.0 m
Initial Top of Plug from POOH (Uncontaminated POOH Simulation)			2215.0 m
Estimated Top of Cement after POOH (Final POOH Simulation)			2227.2 m

Final Contamination Risk (from left to right: 9,10)

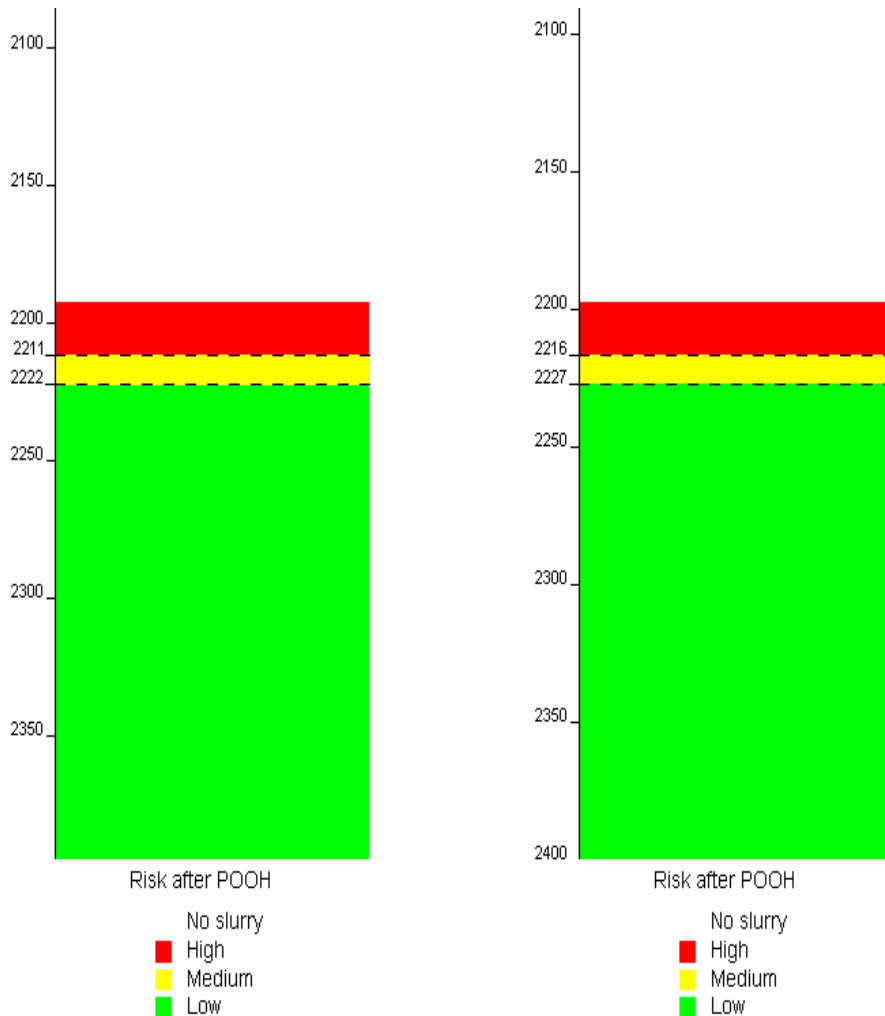

Figure C.5: POOH results case 9-10 **Note : Simulation assumes that fluids are free to balance themselves**