



University of  
Stavanger

Faculty of Science and Technology

## MASTER'S THESIS

Study program/ Specialization:  Master of Science, Petroleum Technology, Drilling	Spring semester, 20.16.  Open / Restricted access
Writer: Frank Michael Mortensen	<i>Frank Michael</i> ..... (Writer's signature)
Faculty supervisor: Kjell Kåre Fjelde      Supervisor : Fatemeh Moeinikia	
External supervisor(s):	
Thesis title:  A New P&A technology for setting the permanent barriers.	
Credits (ECTS):    30	
Key words: <ul style="list-style-type: none"><li>• P&amp;A</li><li>• Thermite</li><li>• New technology</li><li>• NORSOK D-010</li></ul>	Pages:                    98 ..... + enclosure:            0 .....  Stavanger, 14.06.2016 ..... Date/year

[PAGE LEFT BLANK]

# NEW P&A TECHNOLOGY FOR SETTING THE PERMANENT BARRIERS

Master's thesis

Submitted to

University of Stavanger

by

Frank Michael Mortensen, spring 2016

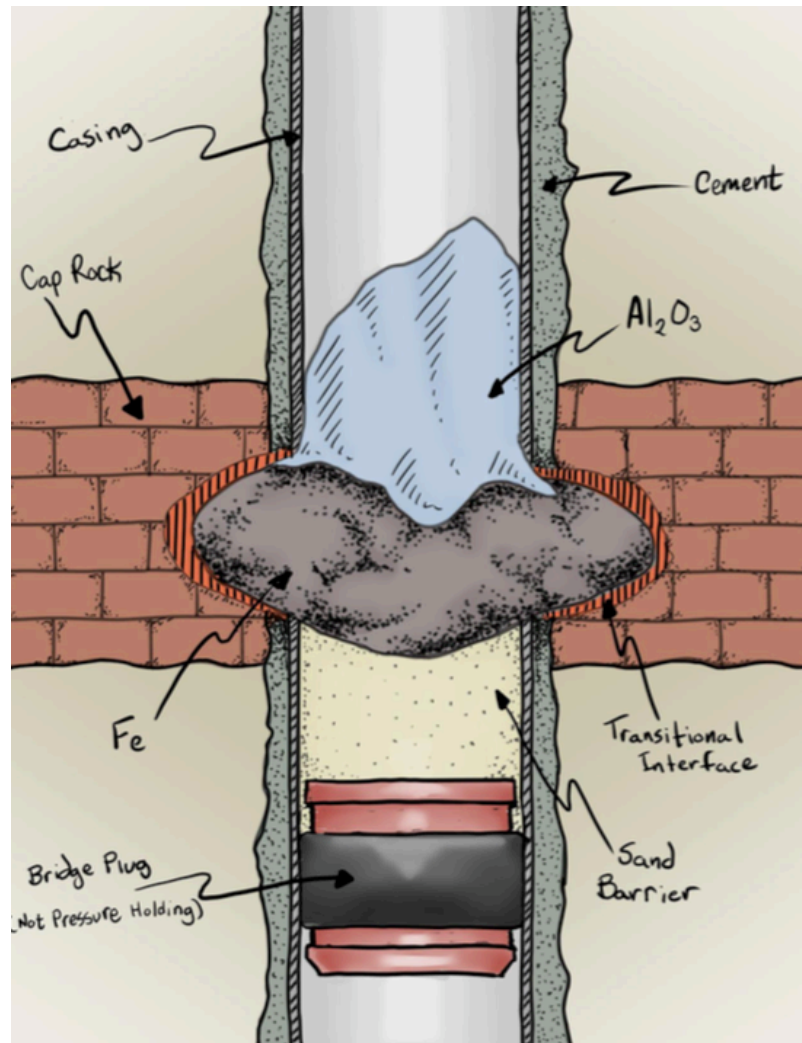

## ACKNOWLEDGEMENTS

Thanks to Fatemeh Moeinikia (UiS) for guidance, support and regular meetings. That was very helpful. Also, thanks to Kjell Kåre Fjelde (UiS) for assigning me with an interesting P&A thesis and helping me get started.

Thanks to Lars Albertsen and Terje Hauan at Interwell who took time out of their busy schedule to give an excellent presentation on the technology presented in this thesis.

Also, thanks to Bill Lowry (Olympic Research) for answering all the questions I had regarding the technology they are developing.

Finally, thanks to Steinar Strøm (Statoil), Martin Straume (BP), Steinar Edholm (consultant) and Asbjørn Josdal (Endswell) for answering many of my questions.

Stavanger  
13.06.2016

Frank Michael Mortensen

## Table of Contents

<b>CHAPTER 1. INTRODUCTION</b>	<b>13</b>
1.1 DESPERATE TIMES CALL FOR DESPERATE MEASURES	13
1.2 COST AND EVOLUTION	14
<b>CHAPTER 2. PLUG AND ABANDONMENT BASICS</b>	<b>17</b>
2.1 WHAT IS PLUG AND ABANDONMENT	17
2.1.1 ACTS AND REGULATIONS	17
<b>CHAPTER 3. P&amp;A REQUIREMENTS</b>	<b>20</b>
3.1 USEFUL TERMS AND DEFINITIONS	20
3.1.1 WELL BARRIERS	20
3.1.2 WELL BARRIER SCHEMATICS	22
3.1.3 WELL INTEGRITY	24
3.2 REQUIREMENTS AND GUIDELINES FROM NORSOK D-010	26
3.3 LENGTH OF WELL BARRIER	31
3.4 VERIFICATION	32
<b>CHAPTER 4. OPERATIONAL PROCEDURE</b>	<b>34</b>
4.1 PHASES	34
4.2 OPERATIONAL PROCEDURE	35

<b>4.3</b>	<b>WELL CONDITION</b>	<b>36</b>
<b>4.4</b>	<b>KILLING THE WELL</b>	<b>37</b>
<b>4.5</b>	<b>PULL TUBING AND CLEANOUT</b>	<b>38</b>
<b>4.6</b>	<b>LOGGING AND PLUGGING</b>	<b>39</b>
<b>CHAPTER 5. P&amp;A CHALLENGES</b>		<b>42</b>
<b>5.1</b>	<b>CONTROL LINES</b>	<b>42</b>
<b>5.2</b>	<b>LOGGING</b>	<b>43</b>
<b>5.3</b>	<b>REGULATIONS</b>	<b>44</b>
<b>5.4</b>	<b>REMOVAL OF CASING STRINGS</b>	<b>45</b>
<b>5.5</b>	<b>MILLING</b>	<b>46</b>
<b>5.6</b>	<b>CASING AND TUBING COLLAPSE</b>	<b>47</b>
<b>CHAPTER 6. VESSELS AND RIG OPTIONS</b>		<b>48</b>
<b>6.1</b>	<b>SUBSEA VERSUS PLATFORM P&amp;A</b>	<b>48</b>
<b>6.2</b>	<b>VESSELS</b>	<b>51</b>
<b>6.3</b>	<b>DRILLING RIGS</b>	<b>55</b>
<b>CHAPTER 7. THERMITE TECHNOLOGY</b>		<b>58</b>
<b>7.1</b>	<b>INTRODUCTION</b>	<b>58</b>
<b>7.2</b>	<b>THERMITE</b>	<b>59</b>
<b>7.3</b>	<b>INTERWELL</b>	<b>63</b>

<b>7.4</b>	<b>EXTREME TECHNOLOGY</b>	<b>63</b>
<b>7.5</b>	<b>OUT OF THE BOX THINKING – INTO THE SANDBOX TESTING</b>	<b>64</b>
<b>7.6</b>	<b>DESCRIPTION OF THE TECHNOLOGY</b>	<b>65</b>
7.6.1	BASICS	65
7.6.2	A MORE DETAILED VIEW	67
7.6.3	TRANSPORTATION OF THERMITE MIXTURE	67
7.6.4	IGNITION AND BASE	68
<b>7.7</b>	<b>A LOOK AT WHAT NATURE IS DOING</b>	<b>72</b>
<b>7.8</b>	<b>OLYMPIC RESEARCH PROPOSAL</b>	<b>74</b>
7.8.1	HEAVY LOAD	76
7.8.2	USE OF DILUENTS AND ADDITIVES	78
7.8.3	DIRECTIONAL CONTROL	79
7.8.4	CONTINUOUS FEED	83
<b>CHAPTER 8.</b>	<b>DISCUSSION</b>	<b>84</b>
<b>8.1</b>	<b>CHALLENGES</b>	<b>84</b>
<b>8.2</b>	<b>POTENTIAL AND BENEFITS</b>	<b>88</b>
8.2.1	PILOT WELLS	90
<b>8.3</b>	<b>OPTIMISM</b>	<b>91</b>
<b>CHAPTER 9.</b>	<b>CONCLUSION</b>	<b>92</b>





## LIST OF FIGURES

FIGURE 1: HISTORY OF OIL PRICES (SACHS, 2014) .....	13
FIGURE 2: PYRAMID SHOWING THE LEGAL STRUCTURE. ....	19
FIGURE 3: THE SWISS CHEESE MODEL (WIKIPEDIA, 2016C) .....	21
FIGURE 4: WELL BARRIER SCHEMATIC (SPIELER, 2015) .....	23
FIGURE 5: MIGRATION ROUTES (BOARD, 2012) .....	29
FIGURE 6: LENGTH OF WELL BARRIER .....	31
FIGURE 7: INTERVENTION VESSELS (FJELDE, 2013). ....	51
FIGURE 8: COILED TUBING PACKAGE (PETROWIKI, 2012). ....	55
FIGURE 9: JACK-UP WITH CANTILEVER (WISHAHY & BREKKE, 2012).....	56
FIGURE 10: JACK-UP ESPECIALLY WELL-SUITED FOR P&A (STANGELAND, 2016) .....	57
FIGURE 11: THERMIC REACTION (INTERWELL, 2016C) .....	62
FIGURE 12: "THE EARTHMOVER" (FERG, 2013) .....	64
FIGURE 13: EXOTHERMIC REACTION IN THE WELLBORE (INTERWELL, 2016B) .....	66
FIGURE 14: SKETCH OF THE RESULTING PLUG GENERATED FROM THE REACTION (ALBERTSEN, 2016) .....	66
FIGURE 15: TIMER FUNCTION (SKJOLD, 2015).....	68
FIGURE 16: LOWERING TOOL (SKJOLD, 2015).....	68
FIGURE 18: WELLBORE LOADED WITH A HEAT GENERATING MIXTURE (SKJOLD, 2015).....	71
FIGURE 19: THE REACTION MELTS AND CREATES A WINDOW IN THE CASING (SKJOLD, 2015).....	71
FIGURE 22: (INTERWELL, 2016C) .....	74

FIGURE 23: A HEAVY LOAD IS PLACED ON TOP TO REDUCE POROSITY AND EXPAND THE PLUG (W. E. L. A. S. D. DUNN, 2014) ..... 76

FIGURE 24: USE OF TWO DIFFERENT EXOTHERMIC MIXTURES (W. E. L. A. S. D. DUNN, 2014)..... 78

FIGURE 25: CLEAVAGE PLANES ALONG A CENTRAL AXIS IS DISPLAYED IN B (W. E. L. A. S. D. DUNN, 2014) 80

FIGURE 26: A BRIDGE PLUG IS CREATED BY THE REACTION IN THE BOTTOM OF THE WELLBORE (W. E. L. A. S. D. DUNN, 2014) ..... 81

FIGURE 27: A LONG COLUMN OF THERMITE IS PLACED IN THE WELLBORE. BY IGNITING THE MIXTURE AT THE BASE, THE REACTION WILL IS FED FROM THE OVERLYING MIXTURE, CREATING A CONTINOIUS FEED (W. E. L. A. S. D. DUNN, 2014) ..... 83

FIGURE 28: PHASE DIAGRAM, CARBON DIOXIDE (CO<sub>2</sub>) ..... 86

FIGURE 29: PRESSURE CELL BUILT TO MIMIC REACTIONS IN A WELLBORE ENVIRONMENT (ALBERTSEN, 2016) ..... 87

FIGURE 30: TIME CONSUMPTION DURING P&A OPERATIONS (INTERWELL, 2016C) ..... 89

## LIST OF ABBREVIATIONS

P&A: Plug and Abandonment

NORSOK: Norsk Søkkel Konkuranseposisjon

CT: Coiled tubing

WL: Wireline

OR: Olympic Research

BHP: Bottomhole Pressure

WBE: Well Barrier Element

ECD: Equivalent Circulating Density

UKOOA: Oil & Gas UK

PJU: Pulling and Jacking Unit

## ABSTRACT

This thesis presents an innovative way of plugging wells in the near future. The technology is based on various exothermic reactions lowered into the well at desired plugging depths. The ensuing reactions melt and engulf everything in its proximity. The end result is a man-made rock/permanent barrier hybrid that restores the cap rock and seals the wellbore. Another application for the technology is to create windows in the wellbore for sidetracks or possible well intervention purposes.

Two different proposals, both stemming from the same principle, are presented. Interwell and Olympic Research are the drivers behind the technologies presented in this thesis.

The technology is still very much in its infancy, but the potential is so grand that it is worth presenting.

General P&A information is presented in the first half of the thesis.

# CHAPTER 1. INTRODUCTION

## 1.1 Desperate times call for desperate measures

What, exactly, is the meaning of the title in Subchapter 1.1? To provide an example, if the reader ever finds himself stranded in a boat, far out in the ocean, with no food or water, the desperate measure might be to drink or eat things he otherwise would not. Since the price of oil took a nosedive from mid-2014 onward, employees have been laid off, rigs have been left without contracts, and vast drops in investments have occurred. This is well known by now, and the hope in the industry is that the price will stabilise at profitable levels over time. It always does, right? Just examine Figure 1 and take a look for yourself.

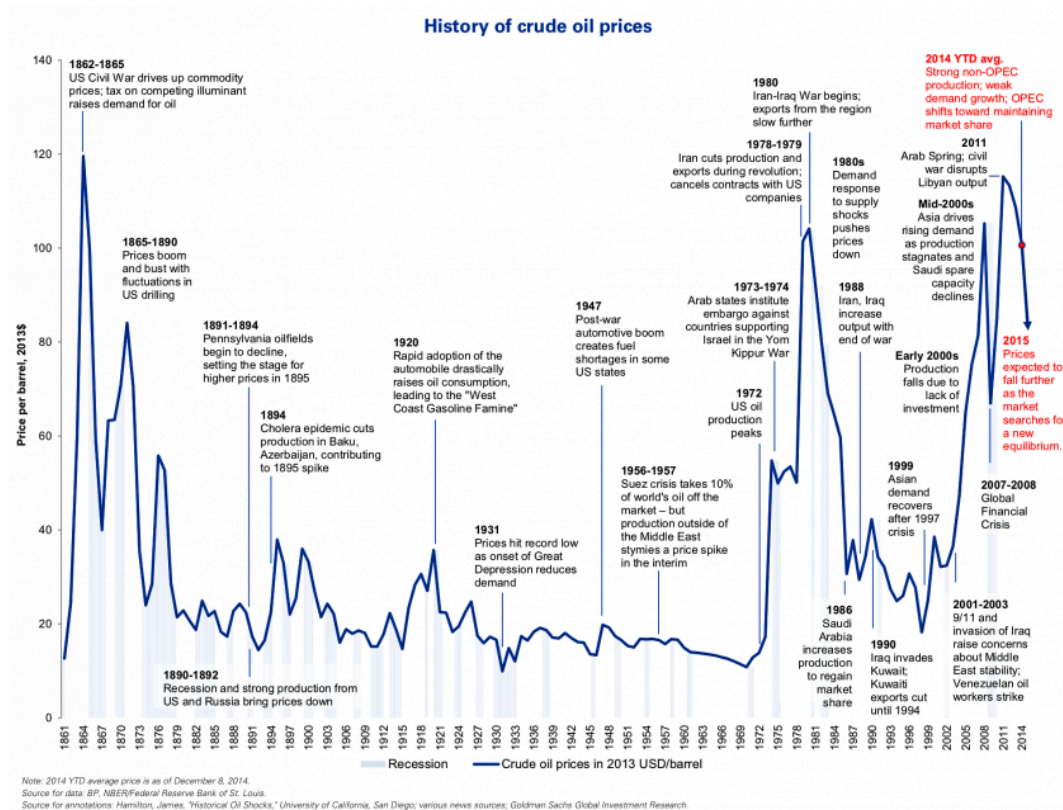

Figure 1: History of oil prices (Sachs, 2014)

However, the feeling is that something is different this time. Cutting costs is the main priority in every office and drill floor across the world. Never before has the need for groundbreaking ideas been more called for. So is this possibly a favourable development, as well? Could this lead to an increased focus on new technology and even extreme measures that likely would not be necessary if a barrel of oil cost more than double today's price? Or are extreme technologies too costly and not worth the investment? In this thesis, a technology that can certainly be described as extreme will be presented. It has been properly funded and tested, and it is scheduled for pilot well testing later this year. Could that be the desperate measure that could help to decrease the substantial cost of more than 2,500 (Øia, 2015) wells that are scheduled for plugging and abandonment in the future?

## 1.2 Cost and evolution

The familiar story in this country is that we struck gold in 1969. Nobody had much belief in substantial amounts of hydrocarbons being located outside the long coast of Norway, but all that changed with the discovery of Ekofisk. Decades later, oil and gas production from the Norwegian Continental Shelf turned Norway into a John D. Rockefeller (a very wealthy man and pioneer in the oil industry) among nations. Recent estimations indicate that revenues from the oil and gas industry have created values of more than NOK 12,000 billion adjusted to current monetary value. The petroleum industry was responsible for almost a quarter of the value created in Norway in 2012 (Regjeringen.no, 2013). Revenues and employment from the oil and gas industry has not only turned Norway into a wealthy country, but also the best country in the world in which to reside; that has been the claim for the past 12 years straight, according to the Human Development Index (HDI). The HDI is published by the United Nations and is a statistical annex based on life expectancy, income, and standard of living (Cripps, 2015; report, 2015).

Production and income from our country's most trusted source of revenue are on a downward trend, however (see Attachment A). Fields are growing older and more complicated to manage, and fewer discoveries are being made. Furthermore, the oil price has plunged, and during its worst stretch, it was cut by 70 % compared with June 2014 (Krauss, 2016).

Desperate times call for desperate measures. Oil companies are, at the moment, hunting for solutions that will cut the cost of operations. Plug and abandonment (P&A) is one of the areas that are receiving extra attention. In a recent study (2015), the estimated cost of plugging wells on the NCS is somewhere between NOK 326 billion and NOK 571 billion depending on the vessel performing the operations (Nissen-Meyer, 2015; Øia, 2015). A study in 2014 estimated that the number is as high as NOK 876 billion (Straume, 2014). Whatever may be the case, the costs are immense.

As of 2015, 352 wellbores are ready for P&A at an estimated cost of NOK 43 billion. The same study estimates that 2,552 wellbores are scheduled for P&A in the near future (Nissen-Meyer, 2015; Øia, 2015). This represents a considerable cost for the oil companies that perform what some are calling the most boring job an oil company is tasked with performing (Taraldsen, 2014). Additionally, it takes valuable time away from their core activity, drilling wells.

Tax rules in Norway ensure that most (78%) of the costs of P&A operations are paid by the Norwegian state. This entails that it is in everyone's interest that these costs are reduced in any way possible.

Compared with other disciplines in petroleum technology, P&A has seen very few improvements in technology in the past decades. There have been several ideas proposed, but apart from the perforate, wash, and cement technology developed by Hydrawell Intervention (Intervention, 2014), little else has materialised. In other disciplines, suitable solutions to complicated problems have been solved in due time.

With the discovery of the Troll field (1979), it was initially deemed next to impossible to recover any of the oil that was present in a thin column on top of the gas reservoir. However, several advancements within well technology, and inventions like the rotary steerable system (Auto-track) from Baker Hughes, soon made it possible (Hughes, 2016). There are numerous examples of similar advances within drilling, subsea and completion. Within P&A, this activity still largely employs cutting, pulling, milling, and mechanical tools. Traditionally, P&A has been something of an extra burden laid upon the shoulders of drilling engineers who prefer to create new wellbores instead of sealing them shut. Consequently, P&A operations are often looked upon as tedious tasks that take up valuable time and resources. As a result, for a long time the remedy was simply to complete this activity as quickly as possible without carefully considering or exploring other possibilities.

In today's climate, ageing wells in several large fields are closing in on the end of their productive life, and the industry is bracing for impact. This also raises an important question: In such a climate, could a new technology emerge and serve as a possible solution to the 571 (or 876) billion NOK question?

Although it is not yet a proven solution, an interesting technology based on thermite is presented in Chapter 7. In the chapters leading up to that technology, a brief introduction to various subjects within P&A is provided.



## CHAPTER 2. PLUG AND ABANDONMENT BASICS

### 2.1 What is plug and abandonment

Imagine a hydrocarbon reservoir similar to a glass of water. Both the glass and the reservoir contain a volume of fluids, and when the fluids are either brought to the surface or consumed, they are gone. When the reservoir no longer contains sufficient volumes of oil or gas, it must be left in a proper manner to ensure that no hydrocarbons escape to the surface. Now the operator is basically faced with two options; permanently plug and abandon (P&A) the well, or option for a slot recovery. Slot recovery entails that the well is plugged, but the option for drilling out in another direction in the same wellbore exists.

NORSOK D-010 rev.4 is the guideline used on the Norwegian continental shelf (NCS) and sets the precedence for ensuring safe drilling and well operations. Chapter nine presents the standards, detailed requirements and guidelines for P&A operations.

Plugging, as defined by NORSOK D-010 is the *“operation of securing a well by installing the required well barriers”* (D-010, 2013). Furthermore, a well barrier is defined as an *“envelope of one or several well barrier elements preventing fluids from flowing unintentionally from the formation into the wellbore, into another formation or the external environment“* (D-010, 2013). NORSOK D-010 does not contain a precise formulation of the term P&A, but to summarize P&A covers the process of adequately isolating and leaving a wellbore in a proper and safe manner.

#### 2.1.1 Acts and regulations

From an internal study at Statoil, the average time to P&A a well between 2000 and 2004 was 16 days (Handal, 2014). NORSOK D-010 revision 3 was published in mid-2004 and in the following period (2004-2010), the average time to P&A a well on the NCS more

than doubled (35 days) (Handal, 2014). Of noteworthy mention from the previous revision was that the well barrier must extend over the entire cross-section of the well, XMT removal requirements as well as section milling examples.

The picture is of course not completely black and white in blaming the increase in P&A time and cost solely on regulations. However, it is an indication of the effect that rules of governing bodies can impose on the process.

On top of the governing framework, and the backbone of how P&A is conducted, is the Norwegian Petroleum Act of 29 November 1996. Under the act, the Norwegian Ministry of Petroleum and Energy ensures that all petroleum activities on the NCS are managed in a proper way ensuring that Norwegian interests are protected (Statoil, 2011).

In Figure 2, one level down on the hierarchy pyramid, regulations are listed. All well operations and plugging on the NCS are governed by the Activities Regulations that are issued by the Norwegian Petroleum Safety Authority (PSA). PSA is “*an independent government regulator with responsibility for safety, emergency preparedness and the working environment in the Norwegian petroleum industry.*” (Norway, 2016)

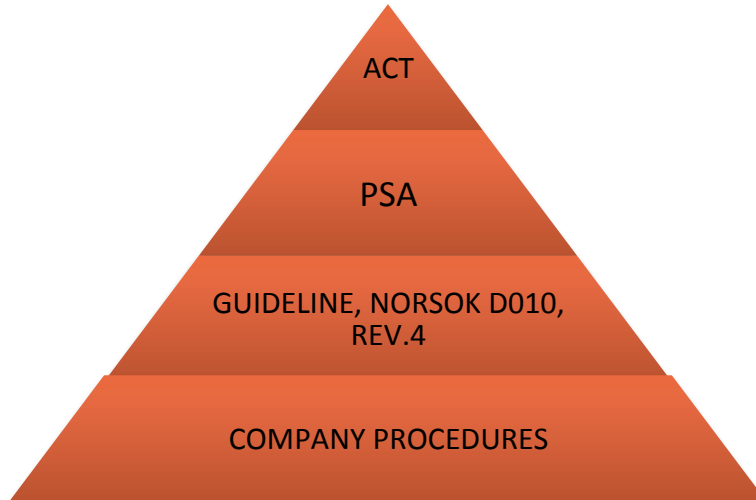

Figure 2: Pyramid showing the legal structure.

PSA recommends that the NORSEK D-010 standard is used as a minimum guideline/requirement for all well operations on the NCS. The standards are developed by the petroleum industry in Norway and based on similar standards for petroleum activity in other regions of the world. Standards from the International Organization for Standardization (ISO) and the American Petroleum Institute (API) are two other examples (Standard, 2015).

It is important to note that the guidelines and therefore NORSEK D-010 as well, only serve to provide recommendations for fulfilling the requirements of the regulations. In short, they are not legally binding and larger oil companies like Statoil, BP and ConocoPhillips have developed internal standards that in many instances are stricter than the NORSEK standards.

## CHAPTER 3. P&A REQUIREMENTS

### 3.1 Useful terms and definitions

Conducting successful plugging operations on the NCS is not as easy as pouring cement into the wellbore, and hoping for the best possible outcome. The acts, regulations and guidelines make sure of that.

At the very core of the Norsok D-010 standards, two terms stand out and are of great importance; well barriers and well integrity.

#### 3.1.1 Well barriers

The following terms and definitions can be found in Norsok D-010 and will be repeated throughout the thesis (D-010, 2013).

*Well Barrier Element – WBE:* A physical element that in itself does not prevent flow but in combination with other WBEs forms a well barrier

*Well Barrier:* Envelope of one or several well barrier elements preventing fluids from flowing unintentionally from the formation into the wellbore, into another formation or the external environment.

*Primary Well Barrier:* A first well barrier that prevents flow from a potential source of inflow.

*Secondary Well Barrier:* A second well barrier that prevents flow from a potential source of inflow and functions as a backup for the primary well barrier.

*Permanent Well Barrier:* A well barrier that permanently seals a source of inflow.

*Common Well Barrier Element:* A barrier element that is shared between the primary and secondary well barrier.

This section is quoted more or less directly from the definitions found in (D-010, 2013).

The term well barrier was introduced in the third paragraph of the thesis and in the definitions section above. In layman's terms, a barrier is a defence system to avoid or reduce effects of accidental events.

The principle of constructing a defence system by installing several individual barriers can be illustrated by the use of the Swiss cheese model introduced by psychologist James Reason (Reason, 1990). From figure 3 it is clear that a single slice of cheese with holes in it is not perfect and cannot prevent unwanted accidents with the desired degree of reliability. However, when aligned, the risk is significantly reduced.

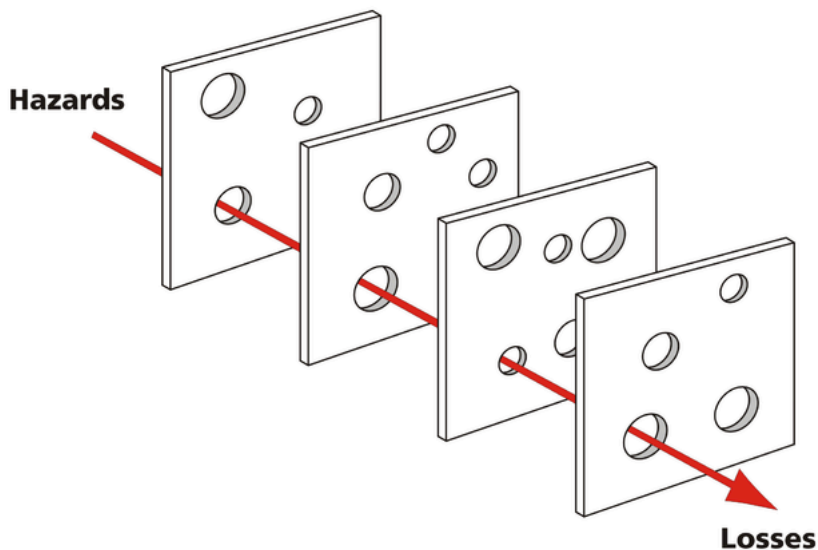

Figure 3: The Swiss cheese model (Wikipedia, 2016c)

The mentioned alignment of slices can be compared to a well barrier and the single piece of cheese, a well barrier element. A well barrier or barrier envelope consists of several barrier elements, but they will only serve as a containing barrier when they are

interlinked into what is referred to as a barrier envelope. Single pieces of equipment like gas lift valves, downhole safety valves, tubing, casing or elements like cement and drilling fluids are examples of barrier elements. Barriers are typically distinguished as technical (failure of equipment), operational (human response) or organizational/human (incorrect management/procedures) (Torgauten, 2013).

### 3.1.2 Well barrier schematics

A graphical representation of the well barrier elements in a well is accomplished by using well barrier schematics. It is recommended by NORSOK D-010 as a practical method to illustrate the well barriers in the well.

*“A WBS shall be prepared for each well activity and operation. A final verified WBS for the well status upon completion of operations shall be in place. Examples of WBSs for selected situations are presented.”* (D-010, 2013)

In a P&A setting, NORSOK D-010 lists several typical abandonment scenarios with examples for selected situations. The wellbore schematic below shows the barrier envelopes with a primary and secondary well barrier. The primary barriers are indicated in blue colour and the secondary barriers with red colour. More examples can be found in NORSOK.

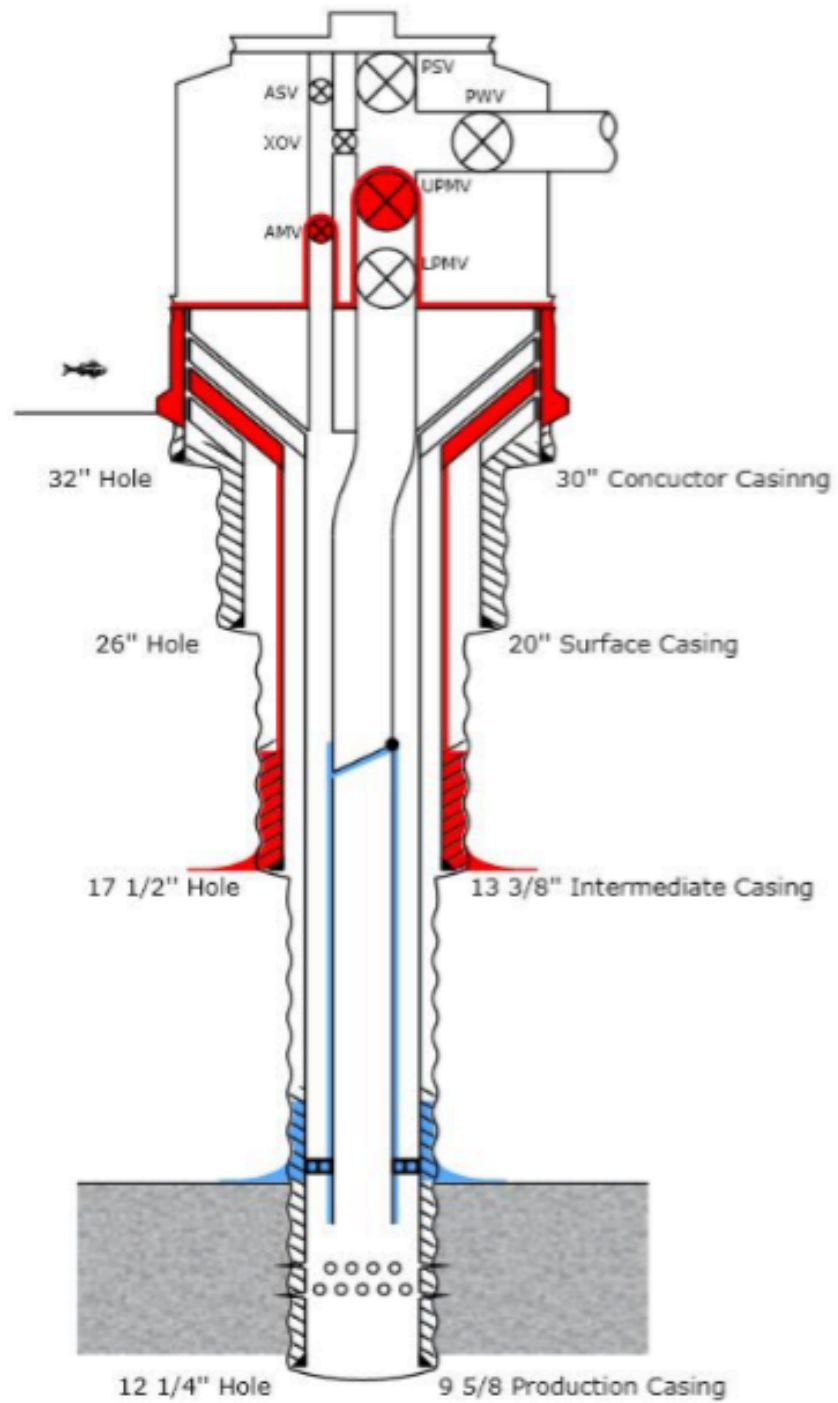

Figure 4: Well barrier schematic (Spieler, 2015)

### 3.1.3 Well integrity

From NORSOK D-010, well integrity is defined as the *“application of technical, operational and organizational solutions to reduce risk of the uncontrolled release of formation fluids and well fluids throughout the life cycle of a well”* (D-010, 2013).

ISO TS 16530-2 gives another definition with validity in the industry: *“Containment and the prevention of the escape of fluids (i.e. liquids or gases) to subterranean formations or surface.”* (ISO, 2014).

Well integrity boils down to controlling, understanding and achieving as little risk as possible during well operations by the use and correct selection of barriers. With aging wells a challenge is often to predict and understand failure mechanisms and manage the well integrity even if many wells greatly extend the forecasted end of life. Apart from aging, effects like wear; fatigue and corrosion must be taken into account. Operational parameters like temperature, pressure and flow rate vary over time and the status of well barriers must therefore be monitored and tested through the well’s lifecycle (Vignes, 2011).

PSA has several sections regarding well integrity that are important to mention in conjunction with P&A of oil wells. Below are some of the more important ones mentioned. The preceding information is gathered from The Activity Regulations and The Facilities regulations (Norway, 2011a, 2011b)

#### §48 – Well Barriers

*“Well barriers shall be designed such that well integrity is ensured and the barrier functions are safeguarded during the well's lifetime.*

*Well barriers shall be designed such that unintended well influx and outflow to the external environment is prevented, and such that they do not hinder well activities.*



*When a production well is temporarily abandoned without a completion string, at least two qualified and independent barriers shall be present.*

*When a well is temporarily or permanently abandoned, the barriers shall be designed such that they take into account well integrity for the longest period of time the well is expected to be abandoned.*

*When plugging wells, it shall be possible to cut the casings without harming the surroundings.*

*The well barriers shall be designed such that their performance can be verified.”*  
(Norway, 2011b)

#### §85 – Well Barriers

*“During drilling and well activities, there shall be tested well barriers with sufficient independence, cf. also Section 48 of the Facilities Regulations.*

*If a barrier fails, activities shall not be carried out in the well other than those intended to restore the barrier”. (Norway, 2011a)*

#### §88 – Securing Wells

*“All wells shall be secured before they are abandoned so that well integrity is safeguarded during the time they are abandoned, cf. Section 48 of the Facilities Regulations. For subsea-completed wells, well integrity shall be monitored if the plan is to abandon the wells for more than twelve months.*

*Exploration wells commenced after 1.1.2014 shall not be temporarily abandoned beyond two years. In production wells abandoned after 1.1.2014, hydrocarbon-bearing*

*zones shall be plugged and abandoned permanently within three years if the well is not continuously monitored.*

*It shall be possible to check well integrity in the event of reconnection on temporarily abandoned wells.*

*Abandonment of radioactive sources in the well shall not be planned. If the radioactive source cannot be removed, it shall be abandoned in a prudent manner". (Norway, 2011a)*

### 3.2 Requirements and guidelines from NORSOK D-010

NORSOK divides P&A operations into temporary abandonment, permanent abandonment, suspension of well activities and permanent abandonment of a well section for side-track purposes. Unless otherwise specified this thesis focuses on permanent abandonment operations. The term permanent abandonment entails that the wellbore wont *"be used or re-entered again."* (D-010, 2013)

*"A permanent well barrier should have the following characteristics:*

- a) Provide long term integrity (eternal perspective);*
- b) Impermeable;*
- c) Non-shrinking;*
- d) Able to withstand mechanical loads/impact;*
- e) Resistant to chemicals/ substances (H<sub>2</sub>S, CO<sub>2</sub> and hydrocarbons);*
- f) Ensure bonding to steel;*
- g) Not harmful to the steel tubulars integrity. " (D-010, 2013)*

A few comments on the characteristics listed above. Very few studies have verified well barriers designed for long-term integrity and especially an eternal perspective scenario. The Foundation for Scientific and Industrial Research (SINTEF) has conducted aging experiments on a number of materials for different clients. For the petroleum industry accelerated aging tests have been conducted on XLPE cables in simulated subsea conditions as well as the validity of epoxy resins' ability to provide long-term isolation. The outcome of this test is confidential (Vignes, 2011).

The most used material for plugging is Portland cement. Even though the technique and mixture has been around for ages, it has been greatly improved by the use of additives (retarders, accelerators, loss circulating materials, etc.) and advances in well technology. Portland cement is readily available, cheap, durable and has been extensively field-tested for decades on the NCS. When cement settles and turns into concrete, it essentially becomes a man-made rock. As with rocks, concrete will undergo natural processes that weaken the material, like oxidation and dissolution. However, in an industrial setting the concrete is also subjected to chemicals and acids. Also, the formula of the cement-mixture may be altered to achieve certain properties that can cause weakening over the long term. Downhole conditions like wellbore stability, temperature and presence of gas (CO<sub>2</sub>) are also known to affect the long-term integrity.

The impermeable characteristic is vital in the sense that the whole purpose of a plug is to stop a flow between boundaries. If the material is not of an impermeable nature the fluid simply flows through the plug. It is estimated that the permeability of cap rock could be upward to 1 micro Darcy and as long as the plug does not significantly exceed that number the flow through the plug should not be a problem (O. G. UK, 2012).

Flow through the plug can be greatly affected by fluid injection, as increased pressure tends to decrease the effective stress around fractures and pores, causing them to open. Other factors like rock movement and thermal conditions also play a

considerable role (Ouyang & Daemen, 1996). Tests have also shown that fractured rock could have permeability up to 7000 times greater than an intact rock. Similar tests also show that micro-fractures created during drilling of the wellbore, or pre-existing fractures, in the intersection between the plug and the wellbore, form a natural migration path for fluids.

Shrinkage after the cement or sealant has settled is a contributing factor that decreases the bond between the plug, casing or rock. Several additives or different types of sealants are tested out and improvements are done on this topic. Most materials that go from a liquid state into a solid state will experience shrinkage during the solidification because of chemical reactions.

Shrinkage tests on different sealants show that undiluted Portland cement displays 4 % shrinkage under the testing conditions that were performed in an unconfined environment with no water feed. Optimized Portland blends displayed a 2 % shrinkage percent with a possibility that it could be even lower. The results on other sealants are shown below (Lende, 2012).

- Non-Portland alternative A: 7,5 %
- Undiluted polyester-based resin: 9,4 % (with filler 5,2 %)
- Undiluted epoxy-based resin: 4 % (with filler 2,5 %)
- PlastiSeal: less than 0,1 % (Lende, 2012)

Bonding depends on the materials' wetting characteristics. Wetting in this context implies the ability of a liquid to adhere to a solid surface and maintain contact. Wetting is a result of intermolecular interactions between two surfaces when they are brought together. Also in this context, additives and surfactants can alter the characteristics of sealants. Surfactants (compounds) are well known wetting agents that reduce the surface tension of a substance. This in turn spreads out the molecules on the surface of the substance and increases its wetting properties (Britannica, 2016).

The importance of proper cement jobs and verification of cement plug history is therefore of great importance to achieve close to impermeable plugs. This will be further mentioned later in the thesis (Ouyang & Daemen, 1996).

Figure 5 below illustrates possible migration routes in a cased hole with cement plug.

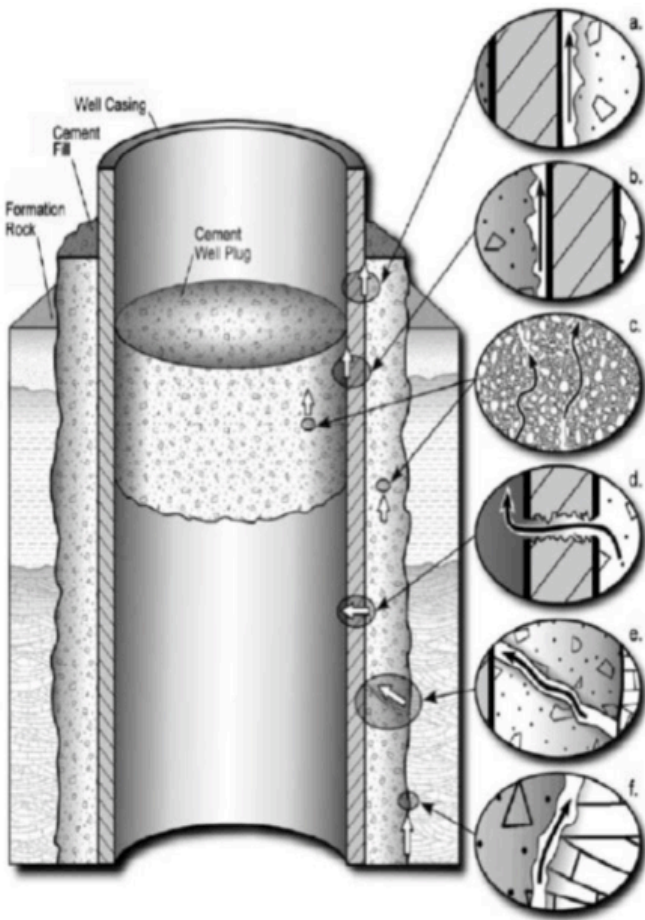

Figure 5: Migration routes (Board, 2012)

Additional requirements for permanent well barriers are listed in well barrier element acceptance criteria tables found in NORSOK D-010. From section 9.6.3 it mentions several important requirements for certain P&A elements. One is that the casing (steel

tubulars) shall be supported, either by cement, or some other plugging material. Another requirement is that the in-situ formation shall have satisfactory integrity and also be impermeable. Also, *“cement in the liner lap or in tubing annulus can be accepted as a permanent WBE when the liner is centralized in the overlap section. The casing cement in the liner lap shall be logged.”* (D-010, 2013)

*“Elastomer sealing components in WBE’s are not acceptable for permanent abandonment.*

*When completion tubulars are left in the well and WBE are installed in the tubing and annulus, the position and integrity of these shall be verified:*

*a) The casing cement between the casing and tubing shall be verified by pressure testing.*

*b) The cement plug (inside tubing) shall be tagged and pressure tested.”* (D-010, 2013)

NORSOK also requires downhole equipment to be removed, and specifically mentions control lines and cables in order to successfully set the well barrier. Also, the *“Permanent well barriers shall extend across the full cross section of the well, include all annuli and seal both vertically and horizontally (see figure 9.6.2.2). The well barrier(s) shall be placed adjacent to an impermeable formation with sufficient formation integrity for the maximum anticipated pressure.”* (D-010, 2013)

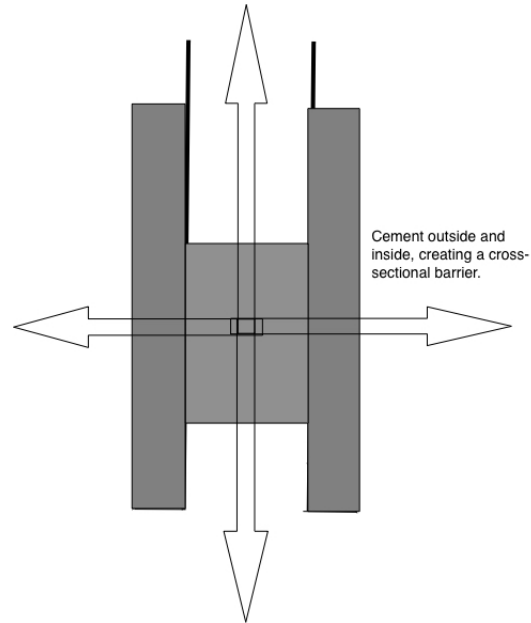

Figure 6: Length of well barrier

### 3.3 Length of well barrier

The length of the well barrier, usually a cement plug, is not based on scientific research, but more from experience and common sense developed from the early days of the oil industry. However, the well barrier should have sufficient strength and ensure a proper vertical and horizontal seal. NORSOK D-010 divides the cross section seen in figure 6 into an external and internal section. The external section is normally considered to be casing cement and the internal section, the cement plug. The requirement is 50 m or 30 m if verified by logging for the external WBE. The internal WBE shall be placed in the interval containing the external WBE and shall be 50 m if set on a foundation. A proper foundation can be cement plugs or different mechanical plugs like the EZSV drillable bridge plug. Without a foundation the length required is 100 m of cement. Further details and specifications are listed in EAC 24 (D-010, 2013).

Mechanical plugs are a popular option in oil wells to reduce the amount of cement needed in the P&A operation. These plugs also provide additional support and protection from formation pressures in the well.

### 3.4 Verification

NORSOK D-010 has outlined rules for verifying WBE(s). “When a WBE has been installed, its integrity shall:

- a) be verified by means of pressure testing by application of a differential pressure; or
- b) when a) is not feasible, be verified by other specified methods.” (D-010, 2013)

Also, the standard requires WBE(s) to be function tested if they require activation. Change in loads or condition “for the remainder life cycle of the well” should be followed by a reverification. (D-010, 2013)

Pressure testing of WBE(s) shall be performed before they are exposed to pressure differentials. If there is suspicion of leaks or vital components are replaced. They shall also be pressure tested if they are set to face pressures they were not originally tested against and if the WBE(s) accidentally were subjected to pressures/loads that surpasses the original well design. Periodical testing are detailed in EAC tables section 15 (D-010, 2013).

NORSOK D-010 details that pressure tests shall be performed against the external environment (in the direction of flow), but if that is not possible and if the WBE seal in both directions, it is acceptable to test against the direction of flow towards the external environment. Furthermore, there is a zero acceptable leak rate, unless other instructions are given in EAC’s. Additional specifications on this point are; *“For practical purposes acceptance criteria should be established to allow for volume, temperature effects, air entrapment and media compressibility. For situations where the leak-rate cannot be monitored or measured, the criteria for maximum allowable pressure leak (stable*



*reading) shall be established.” (D-010, 2013)*

Function tests of WBE(s) shall be performed prior and after installation. If the WBE has been repaired or subjected to loads out of the ordinary and periodical testing as specified in EAC tables section 15 (D-010, 2013).

Testing WBE(s) with pressure in both directions against the WBE is a common procedure. When the WBE has a negative differential pressure, implying that the pressure below the plug is higher than above, it is called a negative/ or inflow test. This is achieved by displacing the well to lighter fluids effectively decreasing the static head. The opposite is often called a positive test.

For high pressure tests, values shall equal or exceed the maximum differential pressure the WBE could face. The pressure reading should be stable and observed for 10 minutes. Prior to this action a low pressure test should be performed. For WBE(s) with an allowable leak rate, 70 bar differential should be applied. A lower pressure could be used if the allowable leak rate is changed in proportion to the differential pressure. Inflow tests have a minimum duration of 30 minutes (D-010, 2013).

The following conditions apply for qualified tests;

*a) “consider the monitored volume when setting the test acceptance criteria;*

*b) establish maximum acceptable deviation from test pressure (x bar deviation from test pressure, e.g. 5 bar for a 245 bar test);*

*c) establish maximum allowable pressure variation over the defined time interval (e.g. 1% or 3.45 bar for a 345 bar test over 10 minutes);*

*d) A condition for the criteria in b) and c) is that the pressure change over time ( $\Delta P/\Delta T$ ) is declining.” (D-010, 2013)*

## CHAPTER 4. OPERATIONAL PROCEDURE

### 4.1 Phases

The Oil & Gas UK (UKOOA) guidelines on well abandonment and cost estimation categorize P&A work into three distinct phases that summarize the work required plugging a well (O. G. UK, 2012).

#### *Phase 1 – Reservoir abandonment*

In this phase, the primary and secondary barriers have been placed and isolated the reservoir. This phase could also include the option of leaving the tubing in the wellbore if that is possible.

#### *Phase 2 – Isolating intermediate zones*

The goal of this phase is to seal zones with flow potential between the reservoir and top of the well. This section of the well is known as the intermediate zone and may contain hydrocarbon, abnormally pressurized or water bearing zones. According to regulations, these formations have to be sealed by barriers. Milling, pulling casing, fishing and setting the plugs are part of the work included in this phase.

#### *Phase 3 – Removing the wellhead and conductor*

Apart from decommissioning (removing the platform from the site), this is considered the latest phase of the P&A operation. It involves retrieving the wellhead conductor and casing strings a few meters below the seabed so that no parts of the well extend above the seabed.

Generally the well is plugged starting from the bottom and ending with the wellhead

removal on top of the well. Also, different vessels are used in the different phases to cost-optimize the operation. Vessels for P&A operations are mentioned further in chapter 6.

## 4.2 Operational procedure

Since P&A operations vary greatly and are dependent on a diverse number of factors, this thesis presents a generalized procedure with some comments intertwined between the steps.

To account for mentioned factors, NORSOK D-010 lists the following information as a constituent for an abandonment design.

*“a) Well configuration (original and present) including depths and specification of formations which are sources of inflow, casing strings, casing cement, wellbores, sidetracks.*

*b) Stratigraphic sequence of each wellbore showing reservoir(s) and information about their current and future production potential, with reservoir fluids and pressures (initial, current and in an eternal perspective).*

*c) Logs, data and information from cementing operations.*

*d) Formations with suitable WBE properties (e.g. strength, impermeability, absence of fractures and faulting).*

*e) Specific well conditions such as scale build up, casing wear, collapsed casing, fill, H<sub>2</sub>S, CO<sub>2</sub>, hydrates, benzene or similar issues.” (D-010, 2013)*

### 4.3 Well condition

Before killing the well and actually starting the P&A operation, it is useful to gather as much information as possible about the well. Many mature fields in Norway have aging wells and although most wells have some available well history, generally they have not been entered for numerous years.

Compiling information regarding well integrity, bottom hole pressures, drift (access to targets in the well), quality of the cement and more, is called well diagnostics. Well diagnostics enables better planning of the P&A operation(s), yields more information in advance and also reduces the risks and unpleasant surprises (collapses, shallow gas, etc.) that could come into play.

A drift run using wireline or coiled tubing accomplishes collecting information about the wellbore and access to the reservoir. The reservoir pressure is an important parameter that commands plugging depth (we need the virgin reservoir pressure for the plug setting depth calculation), material and design. A drift run will also provide information about the state of the tubing, potential collapses and restrictions that will challenge the optimal P&A design because the target of the first plug might be difficult to reach. If the reservoir cannot be reached because of a collapse or deformation (restriction), there is no communication between the reservoir and surface. This can lead to a different approach to killing the well.

If several wells are scheduled for P&A it is usually organized in comprehensive campaigns called batch P&A operations. Especially in large fields like Ekofisk and Valhall, this type of preparation is vital to streamline, organize and accomplish a safe and cost-effective operation.

#### 4.4 Killing the well

Killing the well implies stopping the flow from the reservoir by pumping heavy fluids into the wellbore. The column of fluid will eventually exert a pressure high enough to suppress the formation fluid pressure in the well and achieve overbalance. Forcing fluids back into the formation is known as bullheading and it is the most used technique for killing the well (Oudemans, ter Avest, Grodal, Asheim, & Meissner, 1994).

Brine is a typical heavy fluid used in these kinds of operations, and usually consists of salt solution in water.

As previously mentioned, killing the well can take on a different approach depending on whether there is an established communication with the reservoir or not. If pressure-tests indicate communication with the reservoir, the well is usually killed using the bullheading technique. A hole is made in the tubing (known as punching the tubing) and heavy fluids are pumped down the tubing and up the annulus.

Bullheading is often associated with some risk and during the kill operation, pressure will build up in the wellbore considerably because of the fluids that are forced into the wellbore. This pressure should be closely monitored so it will not exceed the wellhead pressure rating, fracture formations or burst casing or tubing (Oudemans et al., 1994). Lost circulation material, kill fluids and other surface equipment should however be prepared, tested and verified in advance to deal with such potential problems.

In the case where there is no communication with the reservoir, bullheading becomes impossible. The preceding actions will be determined depending on where the restriction is located in the wellbore. If the restriction is at a shallower point, then the desired location of the secondary reservoir plug, usually milling (cutting, grinding the casing), fishing (retrieving objects back to the surface) or other technology is used to bypass the object. This can quickly become challenging scenarios, in terms of time, cost and being

able to comply with the requirements. Ekofisk and Valhall are examples of mature fields where decades of production have caused the chalk reservoirs to compress and thereby enforce movement in the overburden formations. These movements usually result in collapsed casing, tubing or even both as the earth has moved inwards and squeezed the steel in the wellbore (Vudovich, Chin, & Morgan, 1988).

If the deformation is below the desired depth of the planned plug, cutting and pulling the tubing above the deformation usually is a viable option. The wellbore must be cleaned out afterwards.

After killing the well, it is time to enter the wellbore. For subsea wells especially, the xmas-tree configuration becomes an important issue. In the case where a vertical tree is installed on the seafloor, the well needs to have temporary barriers installed before safely removing/pulling the tree. Following instalment of the temporary barriers the BOP is installed and the operation can continue. The process is significantly simpler when a horizontal tree is installed on top of the well. Instead of installing temporary barriers, the BOP is simply placed on top of the tree, or the tree itself can be used as a barrier (Moeinikia, Fjelde, Saasen, Vrålstad, & Arild, 2014).

Tree configuration is a complex topic and it suffices in this thesis to mention that the main differences between the two configurations are the position of valves and the tubing hanger. On the horizontal tree, access to the annulus is incorporated in the design, and removing the tree is therefore unnecessary when it comes to tasks like pulling the tubing or other heavy intervention tasks.

#### 4.5 Pull tubing and cleanout

It is not a requirement to pull the production tubing out of the hole, but generally it becomes necessary. The main reasons being that control lines are frequently attached to

the tubing, creating a possible escape avenue for fluids, or it may be necessary to conduct a logging run behind the casing.

Pulling the tubing can often prove to be a difficult operation and is considered a heavy operation that on platform wells often requires the use of the drilling facilities or other units that can handle the high loads. For subsea wells, jack-ups and semi-submersibles are viable options. In cases where the tubing is stuck and difficult to pull, it is sometimes cut and left in the hole. If that possibility exists, proper barriers must be installed inside and outside the tubing.

The tubing is often connected to the reservoir liner with the use of a polished bore receptacle (PBR). To detach the PBR configuration a fishing tool known as a spear assembly is used.

After pulling the tubing, debris, fill, scale, and swarf (small metal shavings) may be left in the wellbore. Before setting the plugs, a good cleanout is needed to make sure the cement plugs settle properly and that no objects create air pockets or move within the mixture. There are several different fluids with a variety of characteristics for this purpose, but a high-pressure jetting system has become more popular as of late (Tettero, Barclay, & Staal, 2004).

#### 4.6 Logging and plugging

If not done at the diagnostic stage, cement bond logging tools are run to measure the degree of bonding between the cement and casing. If the quality of the cement outside the casing is verified and determined to be of good quality, a cement plug can be set inside the casing. Should the logs indicate poor bonding, lack of a continuous cement sheath or bad quality, section milling or perforate, wash, and cement technology can be applied. This technique will be mentioned at a later stage (Moeinikia et al., 2014).

Apart from validating the height and quality of the seal, channels, cracks and pockets of gas should be detected. There is also the challenge of differentiating between formation, cement, mud and settled barite. This technique will be mentioned at a later stage.

At this stage, it may also become necessary to cut or pull one of the casing strings in order to gain access to log the cement behind the casing or properly place a cross-sectional plug. Today, there are no logging tools strong enough to effectively log through multiple casings (Moeinikia et al., 2014).

The first plugs that will be placed are the primary and secondary plugs that seal the reservoir. In some countries, land wells in Canada especially, the practice is to place the plugs within the reservoir. In most cases, the practice on the NCS is to put a lid on the reservoir by placing the plugs on top of the reservoir. This is fully compliant with the regulations.

In addition to the well barriers that seal off the reservoir, permanent well barriers are required to be installed in the last open hole section of the well. This plug (surface plug) is at a much shallower depth and often times it is necessary to cut and pull both the 9 5/8 and 13 3/8 casing in order to establish a plug that extends the entire cross section of the well (Moeinikia et al., 2014).

According to NORSOK D-010, 9.6.4; *“ For permanent abandonment wells, the wellhead and casings shall be removed below the seabed at a depth which ensures no stick up in the future.*

*Required cutting depth shall be sufficient to prevent conflict with other marine activities. Local conditions such as soil and seabed scouring due to sea current should be considered. For deep water wells it may be acceptable to leave or cover the wellhead/structure.*

*Mechanical or abrasive cutting is the preferred method for removal of the*



*casing/conductor at seabed*

*The use of explosives to cut casing / conductor is acceptable if the risk to the surrounding environment is at the same level as other means of cutting (Example: directed / shaped charges providing upward and downward protection).*

*The location shall be inspected to ensure no other obstructions related to the drilling and well activities are left behind on the sea floor.” (D-010, 2013)*

Cutting knives or, as of late, abrasive water jet technology are the most used options for removing the upper part of the conductor and wellhead. Abrasive water jet technology is basically a high-powered water stream that is supplied with abrasive particles. Explosives are seldom used due to the challenging aspect of controlling the explosion and the health, safety and environmental risks involved.

The final stage involves removing the platform from the site. This is called decommissioning and is often a complex operation with a lot of logistics involved. Decommissioning of the Frigg field took 10 years, and close to 90,000 tonnes of steel was brought onshore for scraping. The decommissioning process can be performed in a couple of different ways, but more often than not whole modules of the platform are lifted onto flat-top barges or a crane vessel that in turn transports the scrap metal onshore (Nåmdal, 2011).

It is expected that after 2020, more than 200,000 tonnes of steel will need to be dismantled per year. Another rough estimate is that the price of decommissioning most of the installations (approximately 500) on the NCS will cost the Norwegian state 160 billion NOK. As is also the case with P&A, the Norwegian state covers nearly 80 % of the costs involved in these processes because of the nation's interest in the oil industry and tax deduction agreements (Nåmdal, 2011).

## CHAPTER 5. P&A CHALLENGES

### 5.1 Control lines

*In this chapter some of the major challenges in P&A operations are presented.*

As mentioned earlier in the thesis, control lines are often attached to production tubing in modern well completions. Pressure gauges, sliding sleeves and temperature sensors are examples of equipment that function with the use of control cables/lines. The drawback is that control lines create possible leak paths and micro annuli. The only way of ensuring that these trifling escape avenues don't pose a threat to the permanent well abandonment is to pull the entire tubing. Pulling of tubing and casing requires a lot of time and heavy equipment eliminating smaller and cheaper vessels for these kinds of P&A operations.

Both UKOOA and NORSOK D-010 are very clear on this requirement.

From NORSOK D-010:

*“Control cables and lines shall be removed from areas where permanent well barriers are installed, since they may create vertical leak paths through the well barrier.” (D-010, 2013)*

From UKOOA:

*“ With current technology, cables and control lines should not form part of permanent barriers, since they may be a potential leak path. This includes cables and lines associated with the completion or casing/liner.” (O. A. G. UK, 2015)*

There are several suggestions on different kind of cutters that can solve this issue and technology to verify that the job is successful. Examples are the mechanical pipe cutter

from Baker Hughes and the mechanical cutter from Welltec. There are also solutions where cutters are installed with the completion, but all of these solutions are yet to be fully successful or properly field proven (Hughes).

In short:

- Control lines create possible leak paths and it is required that they “*shall be removed from areas where permanent well barriers are installed.*” (D-010, 2013)
- Only satisfactory solution is to pull the entire tubing

## 5.2 Logging

Verifying cement as part of the barrier plug is a great challenge in various ways. The way it is done is traditionally by logging with the CBL/USIT logs as previously mentioned. The main problem with these logs is that the signals have a short penetration depth and are often difficult to interpret because of disturbance by mud, scale or steel. Interpreting the logs is also based on personal opinions and experience that is often exclusive to suppliers. It is also common that repeated logging jobs over the same interval in the same time period produce different results. Adding all these uncertainties to the equation, heavy machinery is regularly needed for tubing or casing pulling or even milling to get a look at the cement behind the casing (Weltzin, 2012).

Another problem is that the logging tools cannot log in a downward direction. Having this ability will be helpful in cases where the top of cement (TOC) shall be verified after placement or in damaged/collapsed wells.

- Current logging technology has a short penetration depth
- Not able to log through several casing strings
- Difficult to interpret and based on personal experience and opinion

### 5.3 Regulations

Several guidelines exist on how to perform P&A operations in different markets all over the world. NORSOK D-010 and UKOOA are among the strictest guidelines (Canada also has strict guideline and therefore P&A operations in which these guidelines are the tenet tend to require increasing time and cost to successfully carry out. The question becomes an issue of how to make the guidelines less strict without comprising health, safety and environment.

The guidelines are also constantly changing. An example of the possible effect that these changes can have on P&A operations was illustrated in chapter 2.1.1 with the release of NORSOK D 010, revision 3. Apart from the possibility of stricter well barrier requirements and verification, changes make it difficult for operators to keep up with regulations and plan for best practices. Also new regulations often pose new challenges, and again, practices that may have taken some time to perfect need changing.

Use of definitions like “*impermeable*”, “*eternity*” and “*non shrinking*” are requirements for barriers listed in NORSOK. However, it is known that a cement plug with 100 % certainty does not fulfil these characteristics. When the standard uses characteristics without an exact definition or that perhaps may never be fulfilled, especially considering the eternity perspective, the guidelines lose credibility.

There are entities in the industry that see need for change also within regulations and guidelines, not only technology. DNV GL is one example. Recently DNV GL issued a globally applicable recommended practice (RP), that according to the company can save as much as USD 32 billion (NOK 267 billion) on the NCS alone. The RP is a guideline that is founded on a risk-based approach where wells dealt with according to their level of complexity, in stark contrast to the prescriptive approach used in the industry today.

*“We believe the time has come to tackle this issue head on by assisting regulators and the industry to establish a new methodology for dealing with the decommissioning of wells. By using this method, hazardous wells will get the attention they deserve, and benign wells will avoid excessive rig-time and expenditure. We're looking at potential cost savings of more than USD32bn on the NCS alone, and even more globally.”* says Per Jahre-Nilsen, business development leader, DNV GL – Oil & Gas. (Bjørsvik, 2015; Janbu, 2016)

#### 5.4 Removal of casing strings

As previously mentioned, casing strings often need to be removed in order to establish barriers that extend the full cross section of the well. This problem often arises in conjunction with current logging technology, restrictions in the well or other reasons. Especially troublesome is the case where there exist formations in the intermediate zone with flow potential. These zones need to be sealed of by a primary and secondary barrier and is often located at considerable depths. This requires long sections of casing to be cut and pulled, and divided in several pieces as it is very challenging to pull the casing in run.

Finally, the last open hole section of the well is secured with the surface plug. Now, the issue often becomes removing not one, but two casing strings.

There are several reasons for cutting and pulling the casing, but more often than not the main reasons are:

- Re-establishing barriers
- Gaining access for logging
- Installing barriers in the intermediate zone
- Sealing the last open hole section with a surface plug

## 5.5 Milling

Several sections in older wells scheduled for P&A contain poorly cemented areas and the only access to remedy the problem is removing the casing and cement covering of the areas in question. The casing alone is not accepted as a WBE and the full cross section of the well should be sealed off (D-010, 2013). If pulling the entire casing is not an option, the traditional way of gaining access to poorly cemented windows is to section mill the casing.

Section milling entails grinding and cutting away the steel in the casing and constructing windows with access to the areas where the plug shall be placed. After the steel in the casing is grinded out of the way, a clean-up operation follows and finally the exposed open hole is made larger by under-reaming. If these steps are successfully concluded, a good foundation is constructed for placing a balanced cement plug in the exposed window.

Apart from being challenging and very time consuming, milling operations generate considerable amounts of swarf left behind in the wellbore. Swarf is damaging to equipment, can lead to an HSE, increases the equivalent circulating density (ECD) and needs special surface equipment to handle returns topside. The increasing ECD can in turn increase the bottom hole pressure, fracture weak formations and cause losses. Damage to equipment can in worst cases occur on critical components like blowout preventers (BOP). Milling knives can quickly be worn out and in turn require frequent trips for replacement. Also, it is not uncommon that the tool-string becomes stuck because of large piles of swarf balled up in the wellbore.

Milling is so problematic that in many cases it should be regarded as a last option only. NORSOK D-010 even includes a flow chart that details how to plan and conduct milling operations.

- Milling is particularly challenging and time consuming
- Generates swarf that poses HSE problems, increasing ECD and the need for special equipment.

## 5.6 Casing and tubing collapse

This challenge usually occurs in mature fields where the reservoir has experienced a subsidence from pressure drawdown. The depleted reservoir causes the overburden formation to shift to the side and downwards. Ekofisk, Valhall and fields in South America are well-documented cases that regularly experience these complications (Vudovich et al., 1988).

When the earth moves into the casing strings, they become crushed and it is nearly impossible to get through them at later stages. If the preferred setting depth is below these collapses, because the formation at the plugging depth should be able to withstand the pressure induced from below, the operator is faced with a problem.

At first, logging and drift runs will be conducted to get a better picture of the deformation, then cut and pull, milling, expanding cement, side-tracking and opening tools are options that could help get down to the desired plugging depth.

There are different technologies under development to combat these problems, especially casing/tubing opening tools. The principle with these kinds of tools is that they exhibit a buttress shape that is pressed towards the collapsed pipe. With sufficient force the idea is that the tool will press open the closed tubing/ casing.

- A particular challenge in fields where the reservoir formations are easily compacted (chalk). This in turn results in field-subsidence and earth-movement in the subsidence-bowl.

- Reaching the desired plugging depth is difficult when tubing/casing or both are deformed.

## CHAPTER 6. VESSELS AND RIG OPTIONS

### 6.1 Subsea versus platform P&A

First a few things about the general difference between subsea and platform P&A. This thesis does not focus on one aspect or the other, but regarding the Interwell technology described later in the thesis, this chapter will be relevant background information.

The operational sequence concerning subsea and platform P&A are roughly equivalent. Depending on platform types, subsea field layouts, and P&A strategy, significant differences can however occur. That is beyond the scope of this thesis though.

Access to the wells and vessels used in the different phases are the main difference between subsea and platform P&A. Subsea vessels are dependent on vessels or some kind of rig in order to access the well because the wellhead is located on the seabed. The different kind of vessels available will be detailed shortly. A great challenge and a major cost factor is of course that the smaller vessels have less capacity and capabilities compared to larger and far more costly vessels/rigs. So the way it works is generally that the smaller vessel will do as much work as it can, using wireline or coil tubing technology. This work is usually preparatory work for phase one, phase two and phase three of the P&A operations. When heavier work for operations like pulling tubing and casing becomes necessary, rigs are mobilized to the location.

Also worth mentioning is that access to the wells on subsea fields is via the riser or light intervention tools like wireline and coiled tubing. Smaller vessels do not have the riser



capability and this in turn excludes the option of circulating the well as well as the limited capacity on heavy lifts like pulling operations. Should they choose to exclusively use a rig during the entire phase, most of the work can be done but at a higher price from the get-go.

A few important challenges related to subsea wells are listed below:

- The wellhead location on the seabed has limited access compared to platform wells. More planning and special equipment is needed during the preparatory stages. Vertical or horizontal trees pose different challenges, and if something should go wrong it is often a time-consuming endeavour to get back on schedule.
- Weather is a challenge for both subsea and platform wells. Several discussions often mention that planning of P&A work should include the “*waiting on weather*” factor that often comes into play. Especially during the winter months, this is a challenge due to increasing wind and wave heights that regularly suspend well operations. Subsea wells use vessels (ships or semi-submersibles) that have mooring, anchoring or dynamic position (positioning based on satellite information) systems. These systems are not fixed to the seafloor with a stable structure the same way a jack-up rig or platform is secured.
- Subsea wells employ more control systems that provide a link with safety systems like the BOP and tree-valves. More complex equipment and access to the equipment increases the time spent performing operations dealing with this equipment.

For platform wells, wireline and coiled tubing can be set up from the platform. Options like jacking units are also gaining popularity. To accomplish the full range of operations usually encountered during a P&A operation (several offshore platforms lack drilling derricks), rigs with desired capabilities are often hired to do the work either from the start or at a later stage when more challenging aspects of the operation will start. Rigs that have cantilevers are usually popular choices because they easily can skid over the

platform and access the various templates rather easily. Maersk Rowan Gorilla VI is a good example of a jack-up rig contracted by ConocoPhillips doing P&A work in the Ekofisk field. Currently it is listed with a day rate of 355,000 \$ (Maritime, 2016).

Another important point is that the core activity for a rig is usually drilling wells. Having the option to dedicate as much of the P&A work as possible over to vessels dedicated and specialized for other undertakings than drilling, naturally allows the rig to keep on drilling/completing wells. Another benefit considered is that allowing vessels to perform work a drilling rig also can perform represents a substantial HSE benefit (Sorheim, Ribesen, Sivertsen, Saasen, & Kanestrom, 2011).

Until recently, rig capacity was a concern in the industry because of high demand and activity in the market. Many operators worried that there would be a lack of rigs for upcoming plans and operations. In turn pointing to supply and demand, the fear was that the day-rate of rigs would increase. Although the rig market today is different compared to a few years back, it remains a valid argument to push P&A technology in the direction of dedicating as much work as possible to smaller vessels and allowing drilling rigs to do what they do best, drill wells.

When it comes to plugging several wells in batch campaigns, a great deal of costs can be saved planning how the operations most effectively should be conducted. An operator could as an example choose to do some P&A work using lighter intervention tools, and then use the rig for the remaining operations like setting primary and secondary barriers or pulling tubing/casing strings.

To summarize:

- Subsea wells are more challenging to P&A compared to platform wells for various reasons. The main cause is access to the wellhead

- Performing most of the P&A work rigless significantly reduces P&A costs
- Vessels can perform many of the P&A procedures which in turn allows the drilling rig to keep on with core activities like drilling and completion.

## 6.2 Vessels

This chapter briefly summarizes the most used and available vessels performing P&A operations in today's market.

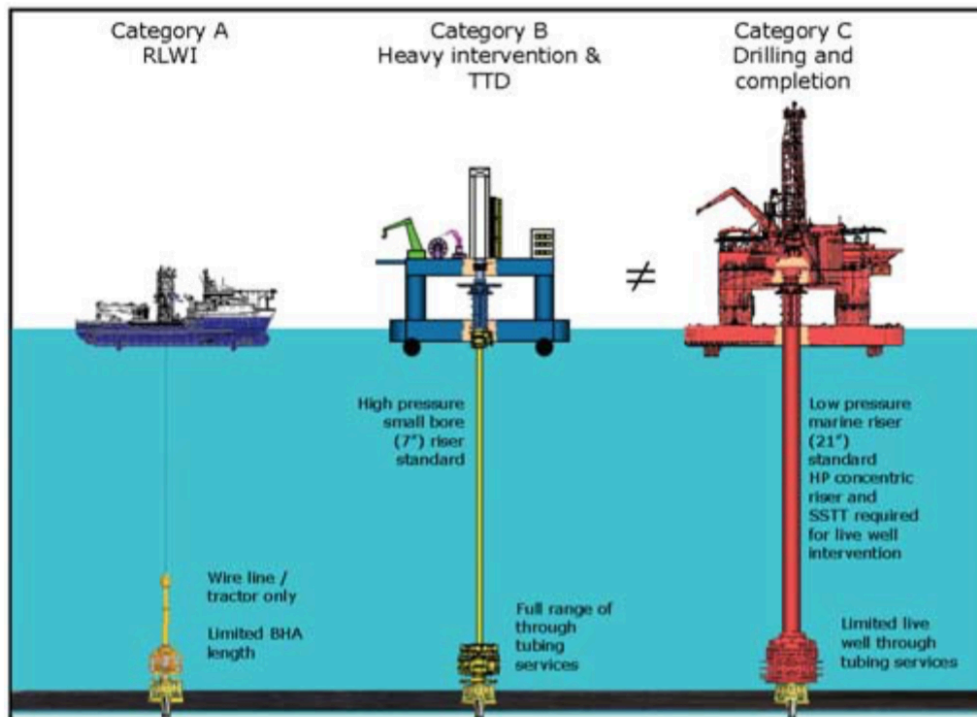

Figure 7: Intervention vessels (Fjelde, 2013).

Vessels accessing subsea wells can be arranged in three categories.

*Category A:* Island Frontier and Island Constructor are examples of Riser Less Well Intervention (RLWI) vessels that primarily perform the preparatory work of phase one, phase two and phase three. Common configurations are monohull vessels that utilize wireline technology.

Data gathering, perforating, well killing, setting temporary plugs and XMAS tree removal are examples of work these vessels can do. In the UK sector, these types of vessels have also been used to place the surface barriers.

Well control during operation is achieved using a well control package and lubricator section arranged in an RLWI stack. The stack is mounted on top of the XMT. When lowering a toolstring with a bottom hole assembly (BHA) through the lubricator a pressure control head is necessary to contain the pressure from the well.

As pointed out previously, this type of vessel may present significant cost savings and the day-rate of a RLWI usually is as low as one third of the cost of a rig (Eng., 2013), (Haga, 2014), (Statoil, 2012).

A drawback is that these vessels are very susceptible to weather conditions and some estimates point in the direction of up to 20 % of operating time spent on WOW.

*Category B:* This is an example of a vessel that could take on more P&A work than a RLWI without the dramatic increase in cost and size compared to a category C vessel. The main advantage is the option of performing coiled tubing services (or wireline). With coiled tubing technology and a small high-pressure riser, circulation is possible. This allows for simpler cement placement and even a possibility for side-track drilling. Since category B was planned as a small rig unit, handling of some heavy equipment and lifting operations could also be a possibility.

During development, the category B vessel was cancelled and the future of this type of mid-range vessel is put on ice. Technology challenges and costs are main drivers eliminating the project from going forward at this time (Statoil, 2013).

Something similar to a category B option is the MODU Q4000 semi-submersible vessel from Helixsg. It is specifically built for performing well-intervention tasks in the Gulf of Mexico (GOM). Two cranes, monopool, coiled tubing and a 7 3/8''-intervention riser are some traits that make it a desirable option for P&A work (Helixesg, 2013).

*Category C:* These are semi-submersible rigs with 21'' low-pressure marine risers and drilling BOP. They allow for a full range of operations with returns to vessel (circulation), well control and ability to manage heavy equipment. The cost of operation makes category C a less desirable option and its main intended use is drilling, not intervention and P&A purposes. Borgland Dolphin (Dolphin Drilling) is currently (april, 2016) listed at a 525,000 \$ day-rate (Maritime, 2016).

*Wireline:* WL is a cable system that involves running or pulling tools in the well primarily for well-intervention purposes. Besides a simple mechanical cable, there is also a braided line that has integrated electrical lines.

A WL package can be employed both on vessels for subsea P&A and on platforms.

Using a tractor makes it possible to reach deeper targets in the wellbore.

For P&A purposes:

- Logging, bullheading (includes pumps and flowlines in the setup), perforation, logging and setting plugs.
- Limited operability in deep wells even with the use of a tractor
- Does not allow for circulation and has no jacking power
- Small diameter allows for less drift signature. Easier getting through restrictions.

*Coiled tubing*: Flexible steel pipe that consists of an endless welded seam rolled onto a tubing reel. CT is run and pulled from the well using a set-up as shown in the picture below. Worth noting is that the injector is the driving force able to force the pipe into the well by overcoming friction and well pressure forces. Specialized BOPs with different ram-setups are needed to perform safe operations with current CT technology.

As is the case with WL, CT can be installed on a platform, drill ships, and Cat B and Cat C vessels.

Compared to regular drill pipes, less people are needed to monitor the operation. A lot of time is also saved not having to make and break joints running/pulling the string. A CT package is also faster to deploy compared to mobilizing a rig and considerably cheaper.

For P&A purposes:

- Ability to take well returns allows for effective well cleaning and plug placement (relatively thin walls of the pipe cause some limitations)
- Cost efficient and time savings on running/pulling string
- Small diameter allows for less drift signature. Easier getting through restrictions.

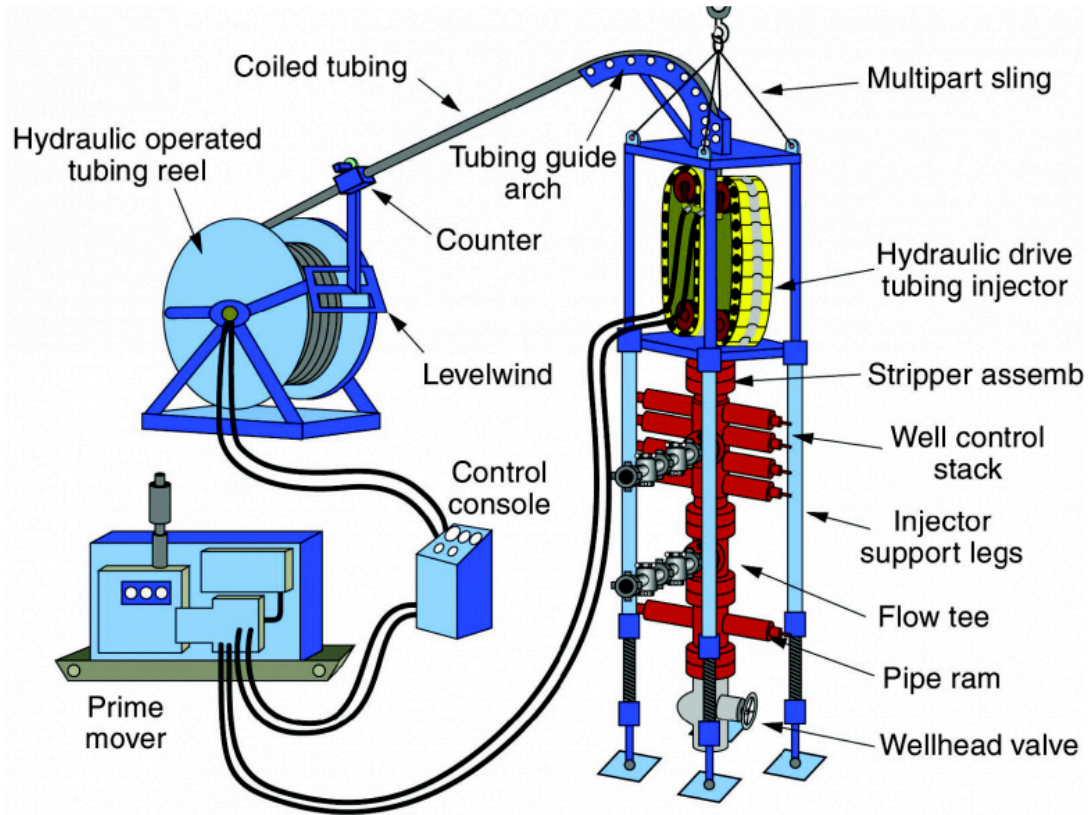

Figure 8: Coiled tubing package (Petrowiki, 2012).

### 6.3 Drilling rigs

Drilling rigs are usually adept at completing the whole range of P&A operations. Compared to vessels, rigs are equipped with drilling derricks, mud handling and supply, pipe handling, well control equipment, hoisting systems, control systems and drilling machines.

Various offshore platforms lack work-over or drilling systems however. If that is indeed the case, the option is usually to assist the platform in mobilizing a jack-up rig. Even though they have high costs, they are mobile, functional and take on most challenges within P&A. Thus it often ends up being the best option. The supporting legs of the jack-

up rig are jacked above the platform, and then the cantilever (containing the drilling systems) is skidded in position above the well.

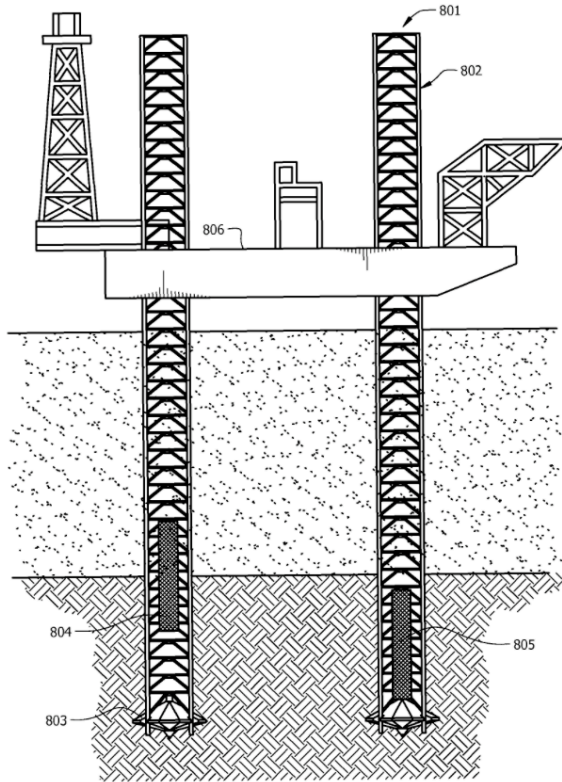

Figure 9: Jack-up with cantilever (Wishahy & Brekke, 2012)

A rig with experienced and well-trained personnel is often able to decrease the cost-gap between rigless and rig-based P&A. A high degree of equipment availability and flexibility, better suited for unexpected challenges and lower operational risk are strong suits in favour of a rig-based P&A approach.

*Modular drilling rig:*

Cheaper options than a jack-up rig are MDRs. Two examples that fall into this category are the Topaz and Emerald MDR from Archer and King 500 from Kongshavn AS. These units are placed on top of platforms, sometimes even removing the in-situ drilling derrick.



They provide a wide range of well operation services and are most likely capable of performing a full scale P&A operation. There exists little information that indicates that MDRs have been in much use on the NCS (Archerwell, 2015).

*Specialized P&A rigs:*

One example of a purpose built P&A rig in development is a custom-built jack-up rig with two dual drilling derricks. The development of the rig is a result of collaboration between the Norwegian Rig Company, Gusto MSC and Cameron. The selling point of the rig is that it can perform drilling operations while simultaneously performing P&A work – a sought-after solution in a market where the major issue of using drilling rigs for P&A work is that it takes time for their intended core activity, drilling (Stangeland, 2016).



Figure 10: Jack-up especially well-suited for P&A (Stangeland, 2016)

### *Pulling and jacking unit:*

Something wedged between the specialized P&A rig and MDR is the heavy duty (or light duty) pulling and jacking unit (PJU) provided by Halliburton to use one provider as an example.

The PJU is a standalone unit that can be fitted to a platform with or without a derrick. If the platform should be equipped with a derrick, the PJU takes care of the P&A operations, which in turn, enables the derrick to continue drilling activities. In the case of offshore platforms that are not equipped with drilling systems, the PJU replaces the need for an expensive jack-up drilling rig.

Depending on the requirements for the job, it comes equipped with a working floor that has an integrated jacking system for cutting and pulling pipe as well as other P&A operations. These units can also come equipped with a crane (Weatherford, 2016).

Some of the benefits of the unit are:

- Skid from well-to-well if it is installed on top of a template
- Far cheaper than hiring a jack-up rig
- BOP is easily available in the undercarriage
- Small footprint on deck, but also available as a cantilever system

## CHAPTER 7. THERMITE TECHNOLOGY

### 7.1 Introduction

The search for the next revolutionary P&A technology is gaining momentum and attention for every passing hour and pulled casing in wells around the world. At this

year's drill-and rigconference in Stavanger (25-26 may, 2016), both Statoil and CoP mentioned the need for technology that challenges the traditional way of solving and approaching P&A problems. Large-scale P&A operations are being conducted on Ekofisk where 70 wells are already plugged with hundred more on the horizon until the license expires in 2028. If further development of the field will go according to current plans, two hundred more wells can be added to the list between 2030-2050 (Frafjord, 2016). Both Tim Croucher, decommissioning manager in CoP and Steinar Strøm, leading P&A advisor for Statoil, called for creative and innovative solutions that think outside the box. “ *We are facing a formidable challenge when it comes to P&A on the Ekofisk field, and we are forced to think outside the box*”, Croucher said to a Norwegian newspaper (Sysla.no) on the conference (Frafjord, 2016). Furthermore the specific challenges regarding deformed well structures on Ekofisk were mentioned as well as the challenge of removing casing deep in the well without having to pull it to surface. Solutions can be found in different industries like, healthcare, military or heavy construction was also pointed out. “ *We primarily want to remove the steel in the well without having to pull it to the surface. We are looking for solutions that are based on melting, erosion or corrosion*”, Croucher said (Frafjord, 2016)

A technology that can prove to be a game changer moving forward and certainly fits the requirement of thinking outside the box is Interwells thermite solution. It is based primarily on melting and not having to pull steel to the surface, perfectly in sync with what Croucher said on this year's conference.

## 7.2 Thermite

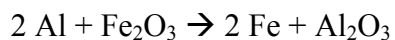

The simple reaction above sometimes called the “*Goldschmidt reaction*” or “*Goldschmidt process*” after the chemist who discovered the reaction in 1893 is best known as thermite. Most fittingly the reaction has also been called “*a blast furnace that fits inside a vest*”

*pocket.*” (Gurstelle, 2014) It is suitable to name the reaction just that because apart from the products of the reaction, iron and aluminium oxide, large amounts of heat are produced in small areas. The heat is so intense that it easily burns through metal if the composition is tuned for that purpose.

Common for this pyrotechnic composition is that it consists of some metal powder composition and metal oxide. In the equation above aluminium (Al) and rust ( $\text{Fe}_2\text{O}_3$ ) are the reactants. From basic chemistry we recall that these reactions are called single displacement reactions.

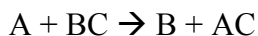

In a nutshell it basically means that one element moves out from its original compound and into a more preferable one. In these types of reactions the saying is that “like displaces like”. From the thermite-reaction it is pretty clear that the aluminium replaces the iron in the compound to produce aluminium oxide and iron. In this case the metal displaces the metal and hence the name single displacement reaction. These reactions usually occur if metal A is more reactive than metal B. More reactive meaning that they donate their electrons more easily compared to other metals. Which metals that are more reactive than others are listed in the activity series. In our example aluminium is listed above iron in the activity series and thus displaces iron from its compound with oxygen. If it were the other way around, iron would not be able to displace the aluminium compound because it is listed below aluminium in the activity series.

Depending on the metal powder mixture, this reaction produces large amounts of energy. Reactions that release considerable amounts of energy to the surroundings are classified as exothermic reactions. Thermite-reactions do not have to include aluminium as a reactive metal, but because it has several advantageous traits compared to other reactive metals it is often the most preferred choice. Some of these traits are low and high boiling points, making it easy to melt the metal and enable high temperatures (approximately

2500 C° and upwards to 3000 C°). Also, aluminium has a low price compared to other highly reactive metals. Reactions where aluminium acts as the reducing agent are called aluminothermic reaction (Exchange, 2016; IndexMundi, 2016; Wikipedia, 2016d)

When Hans Goldschmidt discovered the reaction back in 1893, he quickly realised that the intense heat from the reaction could be useful for welding railroad tracks. And that is exactly what it became useful for at the time. Still to this day railroad tracks are welded together using thermite and crude tools. But, the reaction has also found some use in the military industry as an incendiary hand grenade. Because it readily burns through metal these type of hand grenades have been used for anti-material purposes effectively burning through equipment and vehicles. Other uses involve material-processing, pyrotechnics and synthesis.

When the reaction is activated it will burn at high temperatures and turn into a molten slag, similar to lava. After it has cooled down and solidified the slag has turned into its products, iron and aluminium oxide perhaps mixed with components from a medium that is melted because of the reaction. Essentially what is left is a solid plug.

#### *Some distinctive properties concerning thermite*

- Basic reactants are easy to obtain and stable at room temperature. Requires ignition by an external source and often a temperature above 1200 ° C is needed to set off the reaction Interwell is testing. Basically the components are safe to carry, store and transport.
- Looking at the basic thermite reaction, it contains oxygen, and therefore carries its own supply. This eliminates the need for air-supply which is a basic ingredient keeping a fire burning and it will even burn while being wet. These are properties that could make it ideal in an operating environment like a wellbore

- While the reaction is burning, only fractions of gas is produced. This is another property of the reaction that makes it favourable for use in the oil-industry. Products of the reaction are a molten lava-like slag and of course high temperatures.

In short a thermite reaction can be considered a fairly simple process only involving a metal powder and metal oxide mixture. However when the ingredients are mixed properly large amounts of heat in a fairly controlled manner is released to the environment. The reaction is stable in room temperature and requires an external source of ignition to set it off.

In the figure below, the reactants have a certain degree of potential energy. Not enough to create a reaction however. If the temperature is raised and you achieve ignition, a lot of energy is released. Over some time the reaction releases its energy and the evidence that is left from what happened are the products. In comparison with the thermite reaction, petroleum products rarely burn at temperatures above 1000 ° C. Also the burn rate of the thermite reaction is delivered over some time, hence it wont explode. Depending on the medium in close vicinity with the reaction, it will most likely melt.

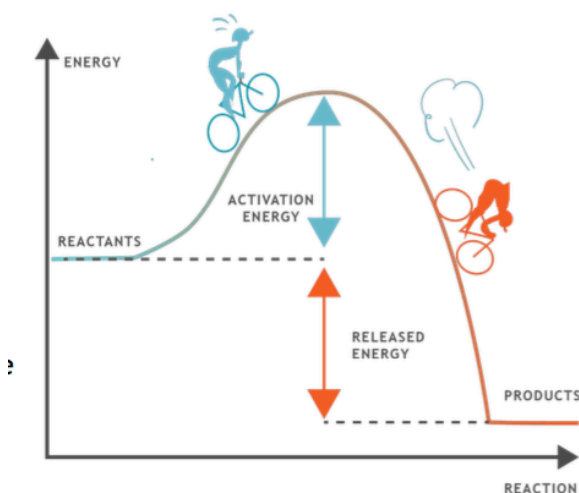

Figure 11: Thermic reaction (Interwell, 2016c)

### 7.3 Interwell

First of all, Interwell is a service company established in Norway in 1992. The company provides technologies and equipment for the oil and gas industry. Primarily the focus has been on supplying downhole equipment and predominantly intervention tools. Bridge plugs for high pressure and high temperature environments are part of the company's product line and speciality. The high expansion retrievable bridge plug (HEX) is an example of said bridge plugs (Interwell, 2016a)

Compared to larger companies like Baker Hughes and Schlumberger, Interwell delivers custom tools with a shorter turnaround time and therefore more often than not, at a higher price. In the last few years Interwell has been working on a solution they are calling "*Interwell's superior P&A solution*". (Interwell, 2016b)

### 7.4 Extreme technology

If not yet proven to be superior, the technology is at the very least classified within the industry as an extreme technology. Extreme in that it proposes a radical new way of thinking within PA as well as that the methodology behind the technology has little resemblance with the way P&A operations are conducted today. Another invention that was investigated a couple of years ago within ConocoPhillips, accurately called the "*earthmover*", is another example of an extreme technology. This technique involved lowering explosives into the casing, detonating and hoping that the following plastic deformation of the casing would seal off channels in the annulus behind the casing. However it was shortly discovered after some trial and tribulations that creating controlled plastic deformations are challenging to say the least. The technique, even though it is shelved at the moment, is a good example of a drastic way of thinking outside the box and challenge the traditional way of doing P&A (Ferg, 2013).

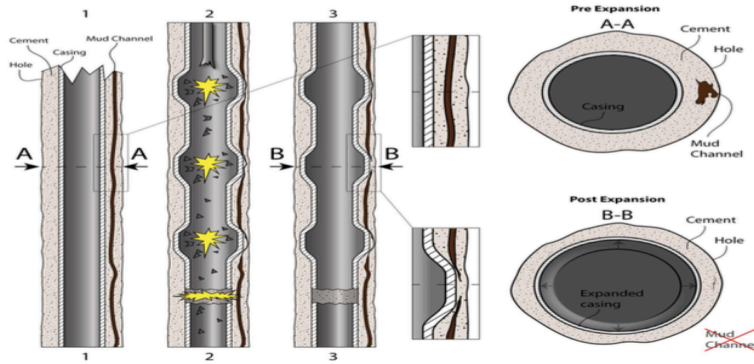

Figure 12: "The earthmover" (Ferg, 2013)

### 7.5 Out of the box thinking – into the sandbox testing

The premise behind the idea of interwells thermite technology was that Michael Skjold, lead technical advisor Interwell, wanted to find a way of moving P&A operations from rigs over to ships. Then after performing rudimentary thermite experiments in his back garden, simply igniting thermite mixtures within steel cylinders, he saw the potential this crude science experiment had and took his ideas to Interwell for further development. For most people the concept and idea behind the technology at first sounded crazy. The potential for cost-saving however allowed the project to grow legs. Now, more than hundreds of small scale sandbox tests have been conducted during the last 3-4 years as well as more thorough, realistic testing (Interwell, 2016b). This will be described in more detail later. To further validate the project Interwell teamed up with DNV-GL and SINTEF that oversaw testing and assisted with consultation services along the way. Also, the project has received Petromax and Demo 2000 funding from the Norwegian Research Counsel. BP and Statoil are also involved via a Joint Industry Project (JIP).

If everything goes according to plan, two pilot wells in Canada are scheduled for full scale well testing in august this year (2016).

To get a decent understanding of how the thermite reaction looks like in real life, Youtube are full of demonstrations similar to what Michael Skjold was doing. Besides



basic experiments a short clip also demonstrates how thermite is used in railroad welding as mentioned previously (Lender, 2011)

## 7.6 Description of the technology

### 7.6.1 Basics

Interwell's P&A solution offers a new (although the idea has been mentioned before) concept within P&A that involves abandoning wells by melting materials in the well. A heat generating mixture is lowered and positioned at desired plugging depths in the well and ignited. Setting off a mixture of aluminium and iron oxide (or other suitable mixture as pointed out in the patent description) creates a powerful exothermic reaction that generates a steady burn of upward to 3000 C °. The ensuing molten slag melts surrounding materials like cement, control lines and casing. Even parts of the formation is affected, especially the parts that are in close vicinity to the heat and slag. After some time, the reactants from the reaction turn into iron (Fe) and aluminium oxide (Al<sub>2</sub>O<sub>3</sub>). The products might have some contamination, depending on what materials that are installed in the well. The main idea however is that the molten slag has removed the casing, cement, control lines, what have you, intruded into the formation and upon solidification turned into a adequate P&A barrier. If the technique proves successful the ideal barrier would be something of a man-made rock consisting of said products with a smooth transition between formation and plug.

Apart from creating a P&A plug, the heat generating mixture could also be used for removing well elements in the well without having to perform milling, cutting, fishing or other time-consuming processes. In the patent description it is mentioned that the technology can prove to be valuable in situations where the operator is creating a deviated well or sidetrack (Skjold, 2013). Often times it is difficult to drill trough casing or tubing to start a deviated well. A heat generating mixture placed at the desired location

could create a window, or weaken the steel in such a degree that the drill bit runs through the steel easily.

Basically, the animations below presents a rough impression of how this technology feasibly might look like in the near future and what Interwell is trying to accomplish.

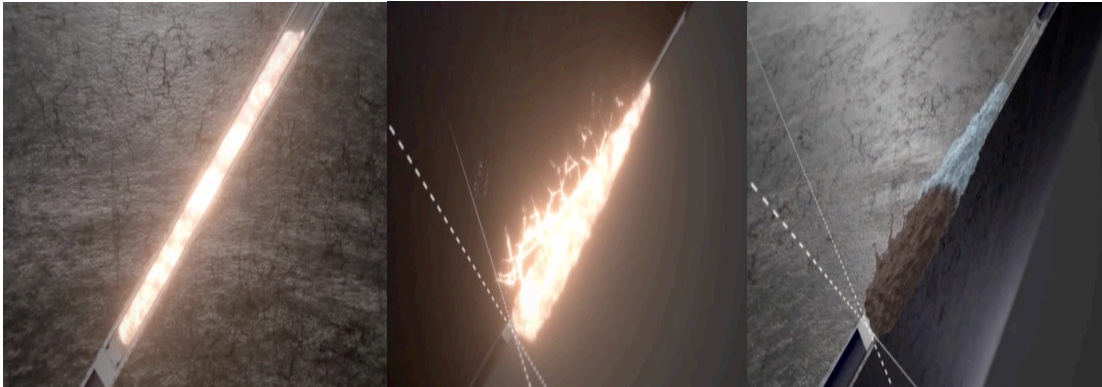

Figure 13: Exothermic reaction in the wellbore (Interwell, 2016b)

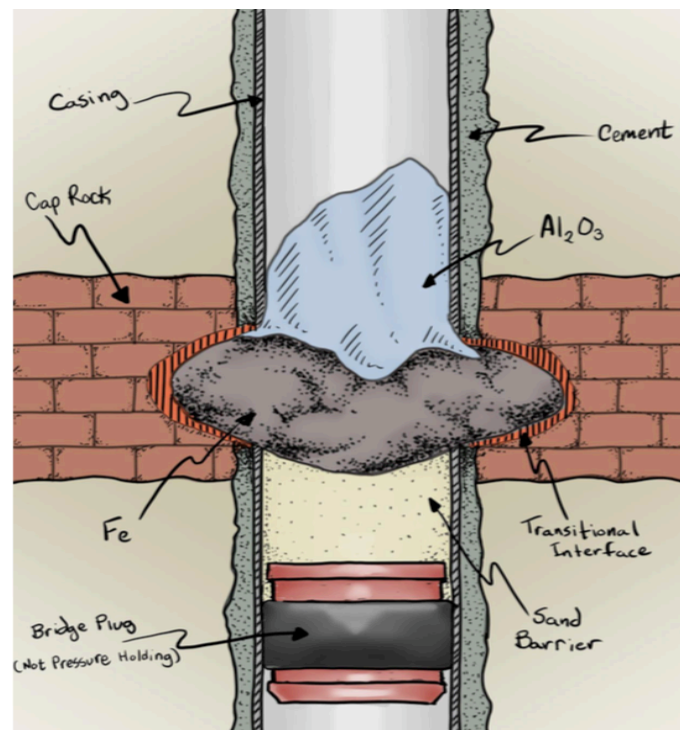

Figure 14: Sketch of the resulting plug generated from the reaction (Albertsen, 2016)

### 7.6.2 A more detailed view

A brief understanding of the invention is mentioned above. In the following subchapters a more thorough description of the invention and planned execution is described. The information is based on presentations, discussions and patent descriptions from Interwell (Albertsen, 2016; W. E. L. S. D. Dunn, 2014).

### 7.6.3 Transportation of thermite mixture

The proposed way of getting the thermite mixture into the well is currently by means of wireline and a container or CT. Another solution that is being considered is pumping the mixture as slurry. Naturally the mixture would have to be mixed with some fluids and sufficient pumping capacity must be achievable if that winds up being a legitimate alternative to lowering the mixture with wireline or CT.

The benefit of pumping the mixture as slurry could be that it covers a larger area of the well, compared to a wireline-tool that maybe is limited to 10-15 meter. A wet slurry mixture in comparison could be stretched out to 100 meter just to use a simple example. In a PA setting where requirements to barriers are 30, 50, 100 meter and so on, this is an obvious advantage. Another benefit could be that slurry could pass deformations/restrictions etc. if that exist in the wellbore.

In the end the goal is to deliver this technology as a through tubing service according to Interwell. Currently, tests will be conducted in wells where the tubing is pulled so the mixture reacts with the casing, cement and formation. Obviously this is simpler since the reaction has to chew through one less layer of steel. In addition the mixture will be exposed to fluids in the annuli after it has melted through the tubing. Convection is just one of the additional problems that arise during that scenario when the reaction is faced

with fluids in the annuli. Conveying tools or pumping mixture through tubing five inches and smaller is another issue. It goes without saying that once the tubing becomes increasingly smaller, it becomes proportionally difficult to convey tools through the tubing. The limited fit through the tubing will quickly turn into unfavorable or unrealistic tool configurations where the tool is very long with a small diameter.

Interwell has mentioned that they plan to follow a stepwise approach where through tubing services are the long-term goal. The focus is first to prove one claim at the time.

#### 7.6.4 Ignition and base

From figure 15 and figure 16, two possible ways of igniting the inserted thermite mix is proposed.

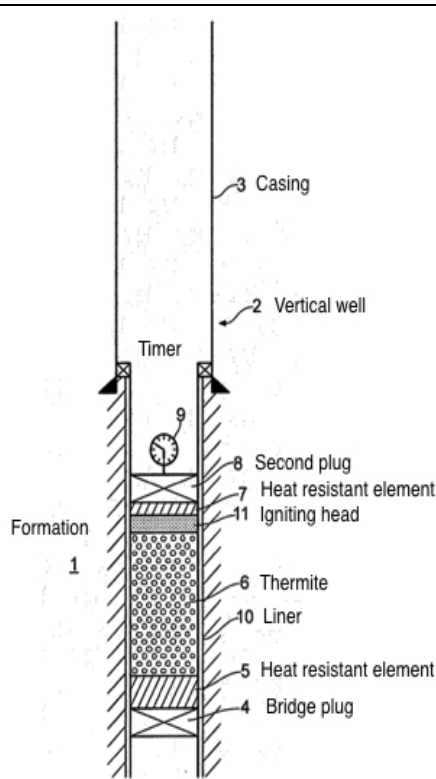

Figure 15: Timer function (Skjold, 2015)

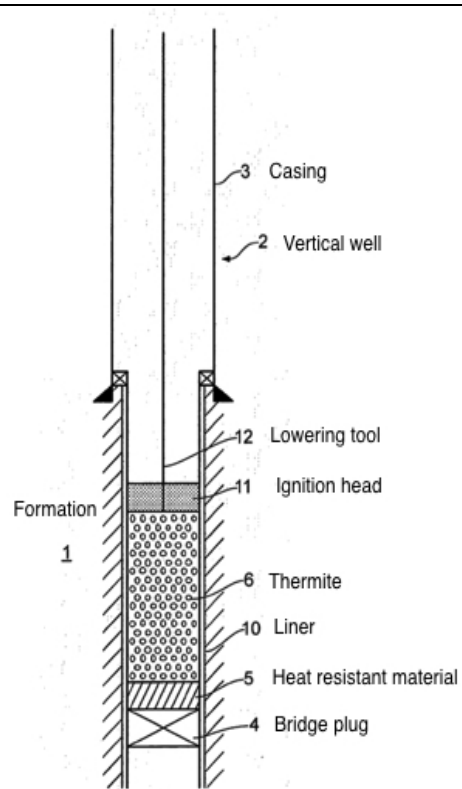

Figure 16: Lowering tool (Skjold, 2015)

In figure 15, a timer function is suggested to initiate the reaction via the igniting head. This could be a desirable function if multiple operations are going on at the same time and setting of the reaction would hinder the sequence of events. Another point is that the operator might be performing a number of operations at the same time from a template and that synchronization of the P&A operations yields better control. A safety aspect is mentioned as a possible benefit in the patent description. If a timer is used, the vessel that performs the operation has time to leave the area before the reaction goes off (Skjold, 2013)

From the figures above, a bridge plug and heat resistant element(s) (one or two) separate the heat generating mixture. The plug works as a base and sealing element while the heat resistant elements protect the plug from the ensuing heat that is generated from the reaction. The heat resistant element could be a sand layer placed on top of the plug or other materials like glass and ceramics. Number of heat resistant elements may depend on the operation and desired outcome. If the heat generating mixture is used to melt a window in the casing/wellbore rather than creating a permanent barrier, numbers of elements are easily altered.

The plug in question could more often than not turn out to be a leaking bridge plug. Leaking implies that the plug won't contain the pressure completely. This is an important aspect because pressure is needed up against the barrier to perform the inflow testing at a later stage in the operation (Albertsen, 2016).

In figure 16, a lowering tool has installed many of the same components as the other version (figure 15). However, in this arrangement the igniter might be left in a tool or set off via an electrical line. Similar to how perforation guns are used today.

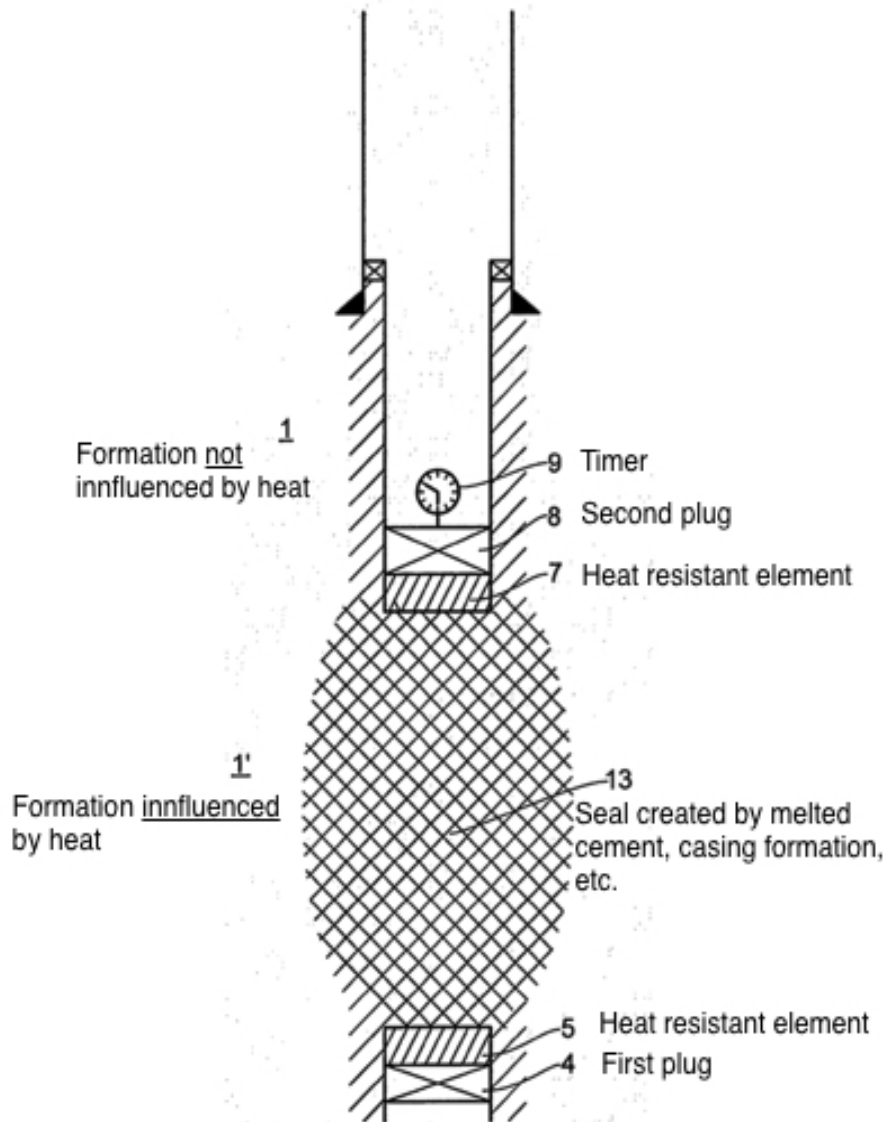

Figure 17: Results from the reaction (Skjold, 2015)

A short time after the reaction in figure 15, the idea is that parts of the liner, cement behind the liner or whatever else might be in the well, are melted into a plug (13). The plug is mainly composed of the products from the reaction creating a barrier that gradually transitions into the formation. The composition of the mixture governs how far the heat stretches out and into the formation. Also, depending on the nature of the formation, it will to a certain extent be influenced by the heat from the exothermic reaction. A basic thermic reaction is often mixed in a 3:1 ratio with say 9 grams red iron

oxide and 3 grams aluminum powder to use an example (Chemistry, 2015). This is the ratio that is used for welding purposes and the resulting reaction is quite rapid and challenging to control. To achieve better control and ascertain different characteristics, additives or diluents can be added to the mixture. As a result, the reaction can be slowed down, cause less gas generation during the reaction phase and change the properties of the final plug. In this sense it is not to unfamiliar with how cement is made. As with the thermite mixture, different mixtures produce different results and fit different purposes.

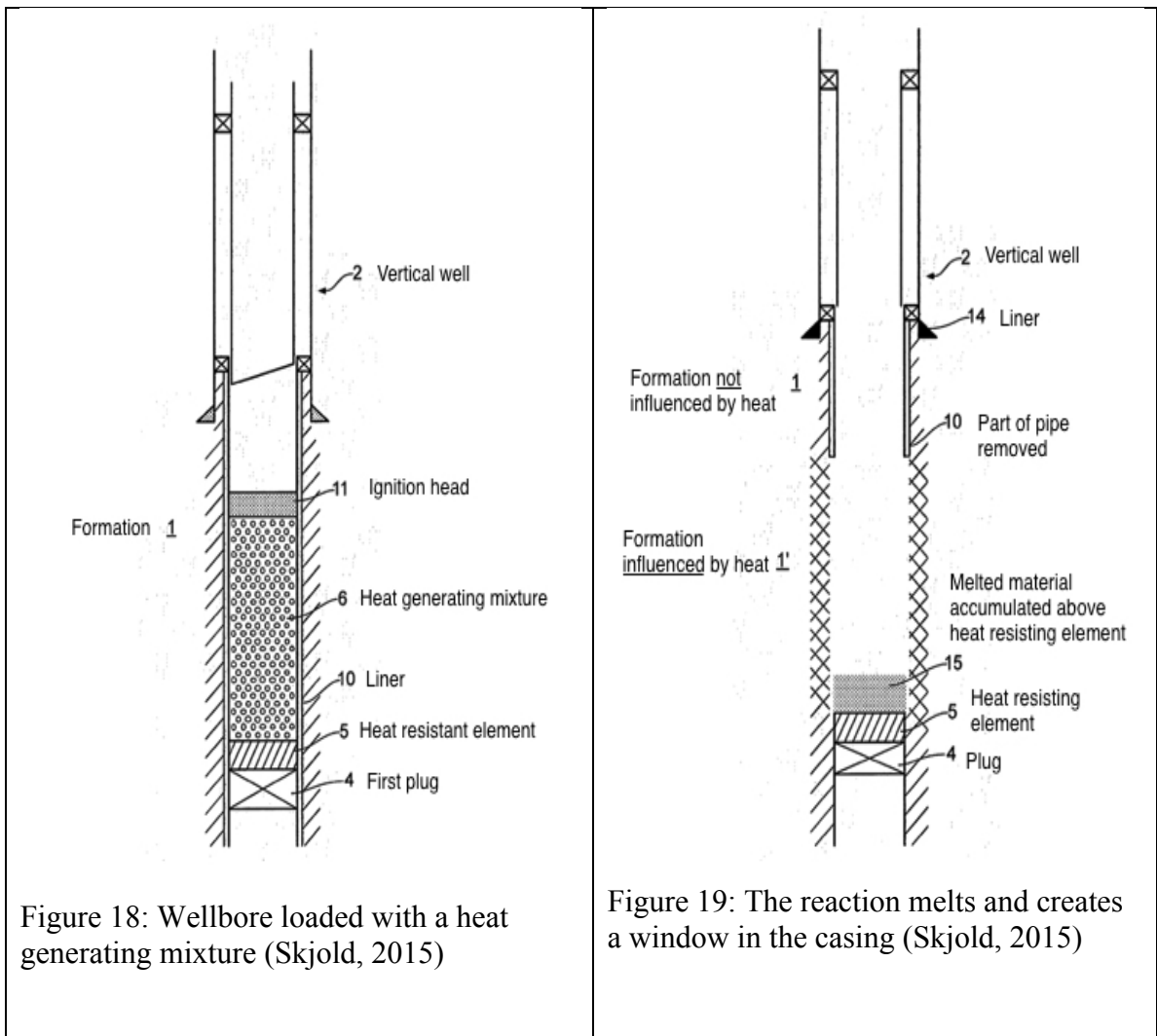

Figure 18: Wellbore loaded with a heat generating mixture (Skjold, 2015)

Figure 19: The reaction melts and creates a window in the casing (Skjold, 2015)

As already stated the technology can also be used to create deviated wells more efficiently by melting well elements. Figure 18 and 19 illustrates how Interwell envisions how a window in the casing for a well deviation might be created. First a heat generating mixture is ignited (6); then the following reaction melts and creates a window in the casing as seen in figure 19. Finally the melted material from the reaction accumulates on top of the plug and heat resistant element (15).

### 7.7 A look at what nature is doing

A premise and somewhat the ideal situation Interwell is trying to recreate with their exothermic reaction is a process nature has been doing by itself since the dawn of time.

The earth's crust is between 5-70 kilometers depending on your location. Beneath the crust lies magma. Magma is a high temperature (600 °C-1300 °C) mixture of molten rock, volatiles and solid substances (Wikipedia, 2016a). Because magma at many locations on earth has low density compared to the overlying rocks, it will try to find a way to the surface. But, most often the magma will cool down on the way up through the rock layers and solidify into what's called a pluton. Before magma cools down and solidifies, it tries to squeeze through cracks and channels, and on the way sills and dikes are created. These are horizontal and vertical intrusions of magma that has, or has not, solidified before reaching the surface. During flowing, the heat from the magma directly impacts the formation at each side of the flow, sometimes turning it into metamorphic rocks (transformed rock because of heat).

As the earth shifts, evidence of these rock intrusions reach surface, as illustrated in the pictures below.





Figure 20: (Interwell, 2016c)

Figure 21: (Interwell, 2016c)

These pictures also summarize perfectly what has been described above. In the picture to the left, a country rock (rock native to an area) has been intruded by magma. Small cracks or fractures have been forced open by the magma that later solidified and turned into the more brightly coloured rock seen as sills and dikes quite clearly in this example. During the solidification process, the rocks tied into each other and created a tight bond. At the interface between the hot intrusion fluid and the country rock, heat affects the native rock in such a degree that it could transform its present structure. Since the country rock is much cooler than the intrusion medium, crystallization rapidly occurs along the aforementioned interface. And, because this materialise over a brief period in time, a fine or glassy grained zone characterizes the texture and bond observed in figure 21. This phenomenon is known as a chilled margin. It is especially identifiable in sills and dikes (Wikipedia, 2014).



Figure 22: (Interwell, 2016c)

Now, the picture above looks almost like a man-made structure (plug), but actually it is more a result of the processes already described. What Interwell envisions with its technology is that by introducing an exothermic reaction into the wellbore, you will in a short period of time recreate a chain of events similar to the pluton creation that is already described. If the wellbore represents the country rock and the thermite reaction represents the magma, the analogy is not far off. The only thing that is different is that some steel, casing, cement, control lines and/or other elements are melted away during the process. So, in a way Interwell is trying to do what nature is already doing. And in comparison with present techniques (apart from using shale as a barrier) it is as close to achieving the fundamental principle of P&A as it gets, namely to restore cap-rock functionality.

## 7.8 Olympic Research proposal

There is also a second patent filed for well sealing using exothermic reactions (W. E. L. S. D. Dunn, 2014) . This patent is filed by Olympic Research (OR) and was published less

than a year ago. William Edward Lowry, president Olympic Research and Sandra Dalvit Dunn, senior engineer, are listed as the inventors.

OR is a small energy and environmental research firm, founded in 2012.

The version of the technology OR suggests is based on disposal of nuclear waste in boreholes. This concept is under consideration in various parts of the world and also the United States where OR is located.

Also the focus is not to melt through casing and formation in the same degree compared to Interwell's technology. However, many of the same basic principles are very similar. And it is not farfetched to consider that the same principles OR is researching, applies for oil wells. The difference is that boreholes for nuclear waste is potentially larger and situated in selected formations (deep crystalline rock at 3-5 km depth) that are more mechanically sound compared to oil wells (Duguid & Wohletz).

Interwell could very well have thought of the same principles or are planning on integrating the same principles at a later stage, but that is not the knowledge of the author at this moment.

Some of the alterations distinguishing the patent from Interwell are;

- OR propose a way to achieve directional control of the reaction.
- OR also provides a suggestion that involves loading the thermic charge with a mass to achieve a less porous plug.
- The same load is also used to squeeze more of the reacting material into the borehole wall.
- There are also variations of setups dealing with different layers of thermic reactions going off at different temperatures.
- Finally there is a setup detailing a continuous feed of reactants to the area where the plug is formed. (W. E. L. a. S. D. Dunn, 2014)

Similar to Interwell's design, Olympic suggests lowering a container of exothermic material into the setting depth and area of the plug. Also in this design, a wireline is proposed as the lowering medium. The reaction is supported on a bridge plug or some other platform. Both the patents describe that the basic thermic reaction is only a starting point for a number of exothermic reactions that can encompass different characteristics like melting point and viscosity. In the following subchapter, four different embodiments to achieve an exothermic plug by OR are presented. OR also introduce a simple design in the beginning of their research, but that design has characteristics that are already covered in the description of Interwell's solution.

### 7.8.1 Heavy load

The first proposal defining how a thermic reaction can be placed in the well and ignited is illustrated in figure 23 below.

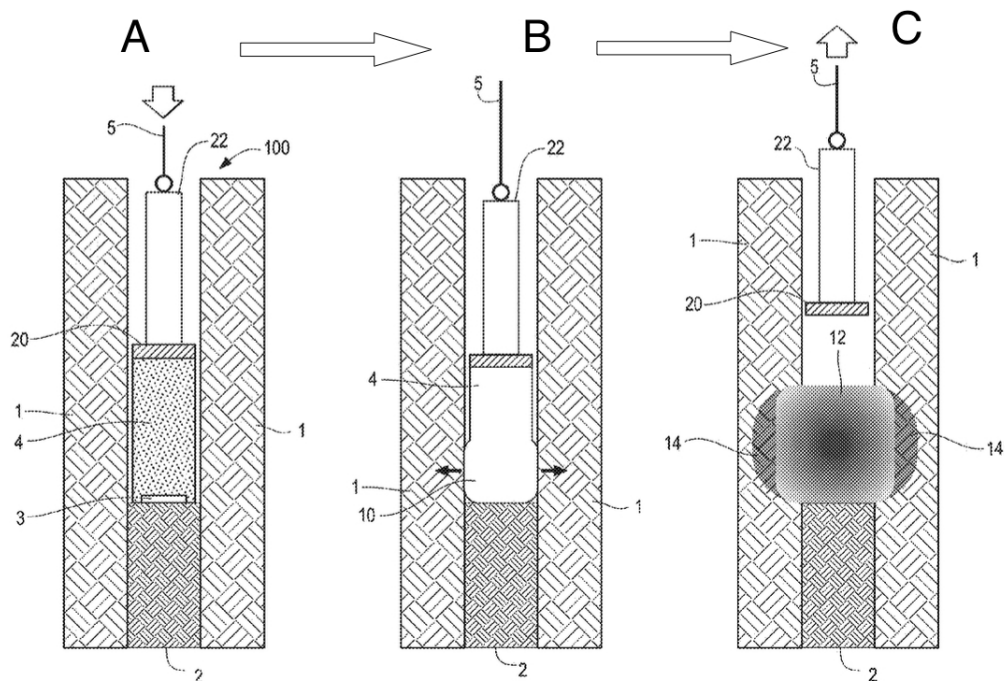

Figure 23: A heavy load is placed on top to reduce porosity and expand the plug (W. E. L. a. S. D. Dunn, 2014)

Numbers displayed on the figure.

1: Formation	2: Bridge plug	3: Igniter
4: Thermite	5: WL	12: Plug
14: Heat	10: Reaction	20: Separator
22: Heavy load	100: Well	

In this illustration a thermite mixture is lowered into the well using wireline. But, unlike the patent proposal by Interwell, a heavy load is placed on top of the separating material. The separating material contains the reaction and prevents the heavy load from being damaged and stuck. In the bottom an igniter is placed. Once the reaction is ignited (B) it will set off the thermic reaction that is compressed by the heavy load on top and contained in the bottom by a bridge plug or other material. The ensuing compressional forces squeeze the reaction outwards and into the formation (open hole) as illustrated in the figure (C, 14). The principle is the same as that of any fluid in a container that is compressed axially. The pressure will escape in the direction of least resistance, which in this case is in the horizontal direction. This is illustrated with the small black arrows in the illustration (B).

The heavy load, suggested to be somewhere in the range of 500 – 1500 kg (W. E. L. a. S. D. Dunn, 2014), has a couple of primary functions. First and foremost it reduces the porosity of the plug formed by the reaction. A more dense and compact plug makes it less susceptible to fluid penetration and also stronger. The porosity comes from the small voids that are created between the grains when the mixture is prepared. A second reason is due to tiny amounts of gas that is created during the reaction. As mentioned, the reaction carries its own oxygen supply. The third function is that the load on top forces the melting slag into the formation, creating a better seal and bond between the wellbore and formation (W. E. L. a. S. D. Dunn, 2014).

## 7.8.2 Use of diluents and additives

As mentioned in chapter 7.6.2, diluents and/or additives can be added to the basic thermite mixture. OR claims that by adding 75 % aluminum oxide powder to the original composition, the reaction temperature can be contained to “only” reach temperatures of up to 1700 ° C (W. E. L. a. S. D. Dunn, 2014). To put that into perspective, steel often melts around 1370 ° C and very few alloys of any composition have melting points above 3000 ° C. Tungsten has the highest recorded melting point of any (pure) metal with 3422 ° C (Wikipedia, 2016e).

Diluting the original mixture also influences the burn velocity of the reaction. In some cases a diluted mixture burns at velocities (0.1 cm/sec) as low as a 100 to 1000 times that of the original composition (10 to 100 cm/sec). According to OR a burn velocity around 1 cm/sec is decent for well sealing purposes (W. E. L. a. S. D. Dunn, 2014).

In the figure below, the principle of manipulating the base mixture is used in a variation that involves two sections with different activation temperatures.

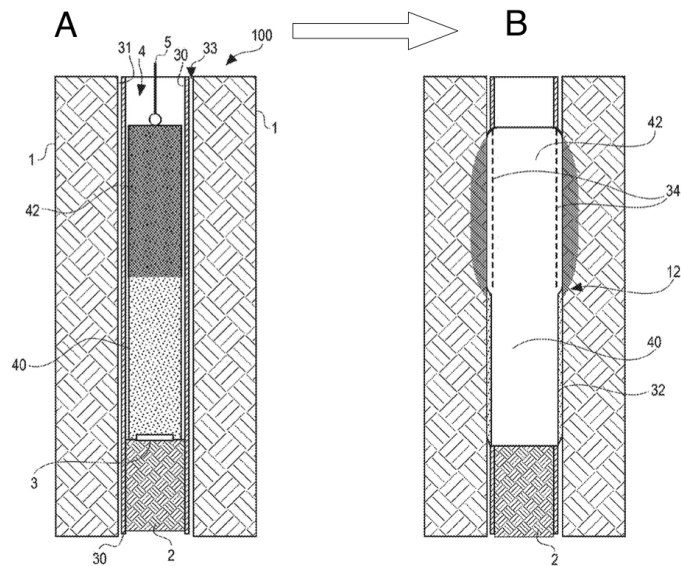

Figure 24: Use of two different exothermic mixtures (W. E. L. a. S. D. Dunn, 2014)

Numbers displayed on the figure.

1: Formation	2: Bridge plug	3: Igniter
4: Charge	5: WL	12: Plug
30: Casing	31: Borehole wall	33: Annular gap
34: Heavy load	40: Thermite low	42: Thermite high

In figure 24, a diluted thermite charge accompanied by a more conventional mixture on top is lowered onto a bridge plug at the desired plugging depth. The igniter (3) is located in the bottom of the diluted mixture as observed in A. The igniter initiates the diluted mixture (40). This reaction burns at lower degrees and a slower velocity compared to the original 3:1 composition. Due to a slower reaction and lower temperature, the casing surrounding the reaction won't melt. Instead the idea is that the casing plastically deforms radially outward and gets shoved into the formation. This idea and concept is reminiscent of the earthmover presented in chapter 7.4. As the reaction burns upwards in the wellbore it will eventually ignite the thermite mixture (42) in the top of the plugging section. This thermite mixture is planned to have a more traditional composition. In effect this involves that the resulting reaction burns at a higher temperature (almost 3000 ° C) and at a higher velocity. The reaction melts parts of the casing and formation. After a short while the molten slag from the reaction works its way further into the formation and downwards in the wellbore on the inside and outside of the casing. Now, an important detail of this set-up is that the molten slag is stopped by the thermite reaction that was initiated at an earlier stage. This way, no parts of the reactions are lost to the surroundings and a more wholesome plug is generated as the reactions have cooled (W. E. L. a. S. D. Dunn, 2014).

### 7.8.3 Directional control

A tweak to the design mentioned in the last chapter involves controlling the direction of the diluted reaction.

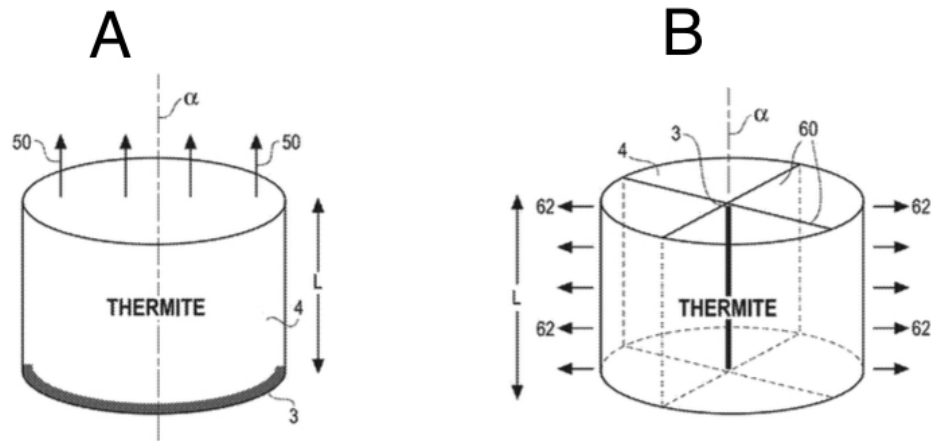

Figure 25: Cleavage planes along a central axis is displayed in B (W. E. L. a. S. D. Dunn, 2014)

Numbers displayed on the figure.

- 3: Igniter                      4: Plug                      50: Diluted reaction direction  
 60: Cleavage planes      62: Radial expansion

Experiments conducted by OR suggest that diluted thermic reactions, acting on planar fronts, expands in the axial direction ( $\alpha$ ). This occurs even when the reaction is unconstrained. Compared to the dry powder-mixture that is placed in the well, the reaction will elongate 10-20 % in the axial direction and minor effects are seen radially (W. E. L. a. S. D. Dunn, 2014). The small increase in diameter prevents the previous mentioned design in chapter 7.8.2 working properly because the casing needs to be pushed outwards in a radial direction. Also the plug won't secure a tight fit. Having the reaction expand vertically is not only a bad thing, because it initiates the thermite mixture located further up in the wellbore. Secondly, the plugs that are generated are longer. Therefore the situation becomes a double-edged sword where there are both benefits and disadvantages with the design.



A possible solution to this problem is detailed in figure 25.

In A, the reaction is ignited in the bottom of the cylinder/wellbore. The resulting reaction transfers axially along ( $\alpha$ ) the centerline and there is minute energy transfer outwards. To achieve added radial transfer of the reaction, cleavage planes and a ignition wire (B,3) is proposed as improvements on the design in A. The cleavage planes could be cuts in the thermite mixture that is prepared before entering the well or some kind of container with oriented chambers or cells. Similar to how oriented perforations are arranged in a perforation gun. This is not clear from the patent-description, but the main idea is that the mixture is arranged in different cuts/sections. Also an ignition wire is run axially in the center of the plug. The activation mechanism is not specified, but again, the main idea is for the wire to ignite the entire mixture in one single action. The cleavage cuts and ignition wire will combine to yield a reaction that encompasses more of the radial effect that is desired. These effects can be combined into the solutions previously presented according to OR (W. E. L. a. S. D. Dunn, 2014).

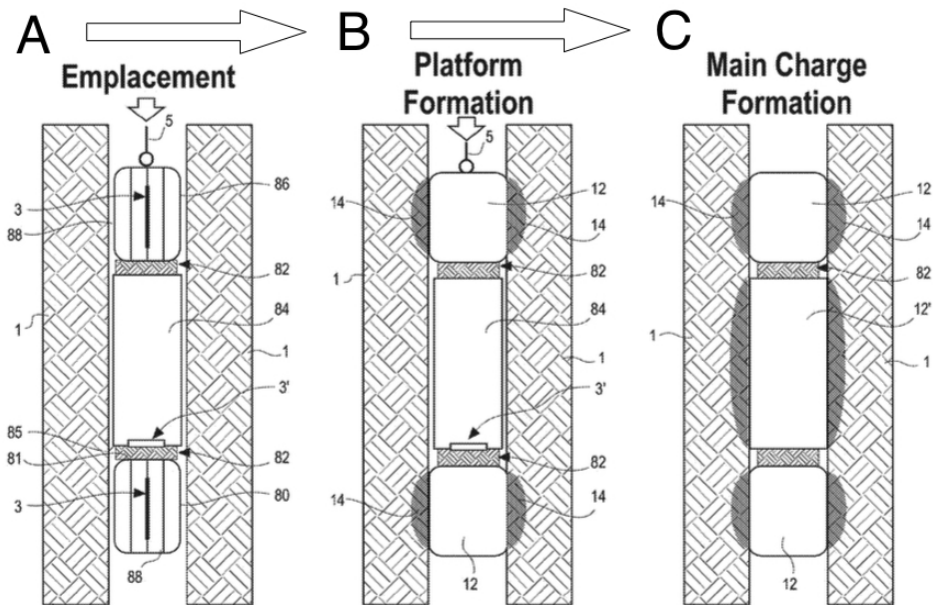

Figure 26: A bridge plug is created by the reaction in the bottom of the wellbore (W. E. L. a. S. D. Dunn, 2014)

Numbers displayed on the figure.

1: Formation	3: Igniter	3': Igniter centerline
5: WL	12: First plug	12': Second plug
14: Casing	80: First plug	81: Upper surface
82: Insulation block	84: Second plug	85: Thermite high
88: Metal jacket with expanding properties		

The design in figure 26 incorporates many of the principles that have been discussed and as an added bonus, its very own integrated bridge plug. First, a thermite reaction tool is lowered into the well at the desired setting depth. Normally a bridge plug is already installed at this stage. However, in this variation, the lower compartment consists of a diluted thermite mixture arranged in cleavage planes (A). Surrounding the mixture is a wire igniter (3) that stretches along the centerline. Both the mixture and igniter is capsuled in a metal jacket (88) that easily expands once the reaction is set off. This capsule could arrange the mixture in cuts or have a machined construction that enables the spreading effect of the thermite mixture previously mentioned. Notice that by using the cleavage planes and a central ignition wire, the desired effect is a low temperature thermic reaction (diluted) that forces the metal into the casing or open hole. Once the reaction cools of, the first plug is installed (W. E. L. a. S. D. Dunn, 2014). There are some savings involved in this design because it neglects the use of an external bridge plug and possibly some extra tripping time can be subtracted from the operational sequence.

The first plug is separated from the middle compartment by an insulation block (82). This detail ensures that the reaction won't ignite the thermite mixture in the middle compartment and also supports containment during the generation of the first plug. Once the first plug has cooled and settled properly it acts as a foundation for the second plug

(84). The second plug is proposed to be of a more conventional character, enabling it to chew through casing and formation.

#### 7.8.4 Continuous feed

Another problem with the exothermic reaction technology is that the size of the resulting plug is largely determined by the size of the container that houses the mixture. OR suggests a remedy to combat that drawback. To better understand the solution a figure is provided below.

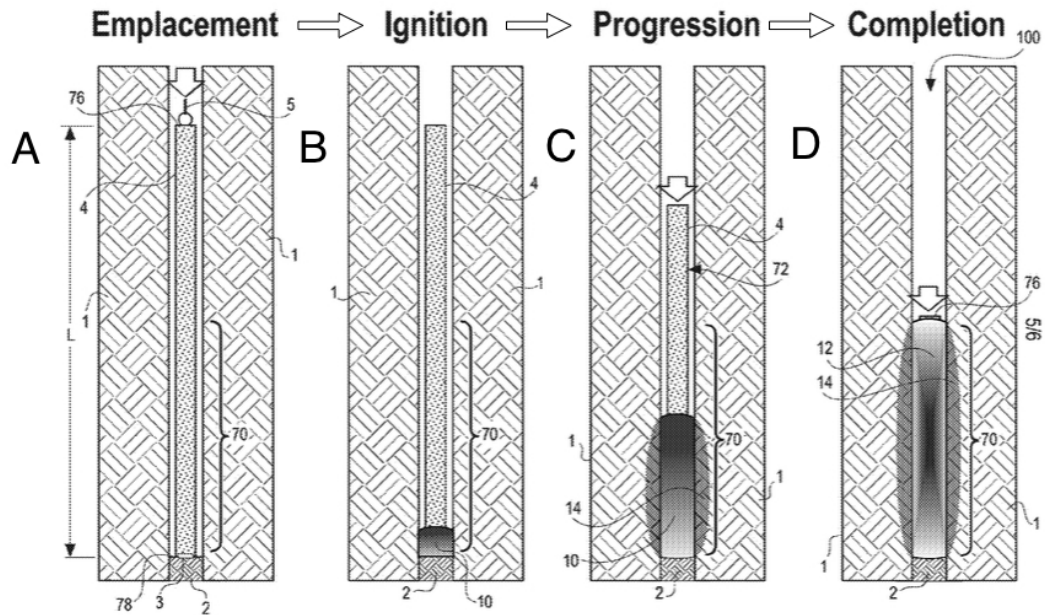

Figure 27: A long column of thermite is placed in the wellbore. By igniting the mixture at the base, the reaction will be fed from the overlying mixture, creating a continuous feed (W. E. L. a. S. D. Dunn, 2014)

Numbers displayed on the figure.

- |              |            |                       |
|--------------|------------|-----------------------|
| 1: Formation | 2: Igniter | 3: Igniter centerline |
| 4: Thermite  | 5: WL      | 10: Reaction zone     |

12: Plug                      14: Heat                      70: Plug zone  
72: Insulation block    76: Upper end              78: Lower end

A thermite charge is lowered into the well and placed on top of a bridge plug and ignition device. Indicated on the figure is a desired target volume for the plug generated by the reaction (70). When the reaction is initiated, (B) a reaction zone is established in the wellbore (10). The column of mixture that is placed in the wellbore continuously feeds the resulting reaction. It is a simply concept similar to turning an hourglass. The drive mechanism is gravity causing the mixture to continuously feed the reaction as it crumbles when the bottom of the reaction is ignited. The reaction melts the casing, control lines and formation as indicated on the figure (C, D). After some time the reactants has turned into a plug.

## CHAPTER 8. DISCUSSION

### 8.1 Challenges

There are several challenges facing a technology like the one that is presented. First and foremost there are presently no regulations that fit the description of the proposed technology. Everything is more or less based on cement today, although that is not a strict requirement, that is what the regulations are founded upon. If a technology like this makes it through testing in real-conditions, the regulations must change in order for this technology to be used on the NCS or other parts of the world. Interwell is in talks with regulators around the world and says that the basic message is that if the company can prove the technology's worth, the regulations can be changed.

Several question marks can also be raised concerning how the reaction will act in a real-life well scenario where there are several unknowns and fluids involved. Interwell has performed hundreds of tests on land with exothermic reactions placed in various set-ups

that in some way or form mimic a downhole environment. The problem however is that these tests are done at surface conditions and often without fluids involved. If you simply introduce a powerful exothermic reaction into a bucket of water it could get serious and turn ugly quite fast. The reason is that when you introduce an extreme heat element to water it expands at such a fast rate. The subsequent boiling, turning water from liquid to gas at a formidable rate, creates what is known as a steam explosion. This is not classified as a chemical explosion, but it is known that aluminium can react with high temperature steam and water. In effect this could lead to oxidization and release of hydrogen that in many situations is the last thing you want if a reaction goes south. Other substances are also known to react with steam in such a way that it turns from a steam explosion into a chemical explosion. It must also be emphasised that a steam explosion could be just as destructive as a chemical explosion (Wikipedia, 2016b).

An important aspect of what is mentioned above is that at plugging depths deep in the well, considerable pressures arise. Taking into account that the exothermic reaction can reach 3000 °C, fluids quickly go beyond the critical point in the phase diagram below. Now the fluid has entered the realm of supercritical fluids. Basically, the fluid no longer exhibits pure liquid or gas properties, becoming indistinguishable. Supercritical fluids have viscosities similar to gas and densities to that of liquids. This means that when the reaction goes off, the fluids near the reaction turn supercritical instead of boiling and creating a lot of gas. This is an effect that actually can turn out to be a good thing also.

Interwell is in talks with companies that are conducting geothermal drilling on Iceland to learn more about these phenomena.

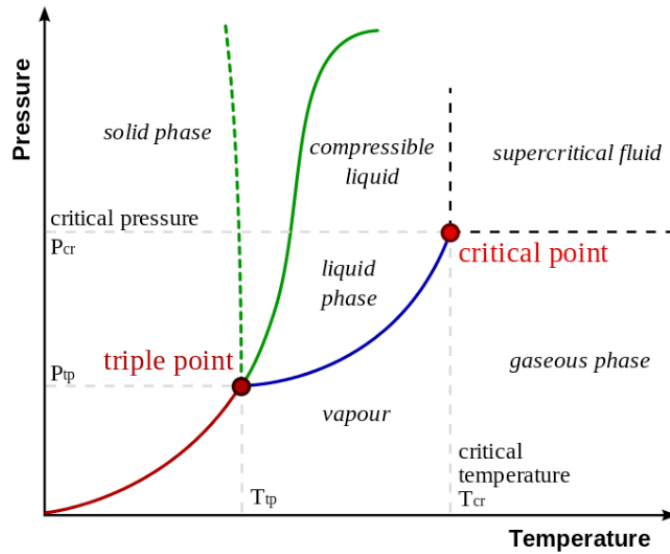

Figure 28: Phase diagram, carbon dioxide (CO<sub>2</sub>)

To further test several of these questions without acquiring a pilot well, a pressure cell was built last year to simulate how the reaction takes place in downhole environment with excessive pressures and temperatures. The pressure cell consists of dual 5-6 meter long cylinders attached to an arm. The arm makes it possible to tilt the cylinder arrangement in different angles. By tilting the cell, different wellbore deviations are simulated. The cylinder to the right is filled with water (and at a later stage, heated), pressurized, and a test-arrangement is lowered into the cylinder. The arrangement can consist of several layers of blocks (cement, rock), casing and tubing that enclose a container encompassing the reaction material. This simulates the components of the wellbore at a desired depth in the well (Albertsen, 2016).

Electric cable is attached to the tool inside the tank and makes it possible igniting the setup from a panel when everything is ready. The electric cable simulates using WL in the wellbore.

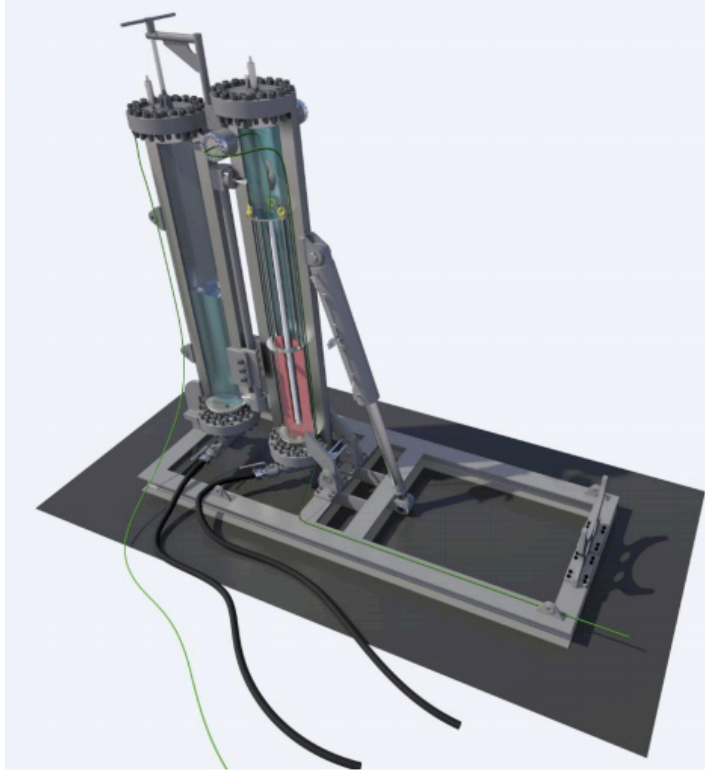

Figure 29: Pressure cell built to mimic reactions in a wellbore environment (Albertsen, 2016)

Because the water in the cylinder to the right is heated and pressurized, an accumulator is placed next to it and interlinked via a connection. The left tank closely resembles the cylinder to the right, but instead it is filled with water and nitrogen gas. Nitrogen acts as a cushion if something should go wrong in the tank where the reaction takes place.

Basically the accumulator is there to facilitate a safe testing environment and avoid that the test tank blows up if something goes wrong.

Interwell reports that the arrangement can simulate pressures upwards of 700 bar and temperatures above 100 ° C. They further mention that testing has gone well and that the reaction ignites and works properly in conditions that come close to real life well environments (Interwell, 2016c).

Another challenge besides wellbore conditions is that if the technology is conveyed with a tool on wireline, deformations in the well might hinder access to desirable plugging depths. Deformations are mentioned earlier in the thesis and represent mayor implications and problems on fields like Valhall and Ekofisk.

Another challenge is to better understand the bond that is created between the plug and the formation. Tests Interwell has run indicate that the bond will become superior to bonding created solely by cement. But, because the reaction occur over a short time span compared to how the proves naturally would occur, cracks have been induced after running tests onshore. These tests are run in environments without the confining pressure that surrounds a reaction in the wellbore however. Also, when the tests are arranged with a confining pressure, no cracks was discovered in the interface zone between the plug and formation. But, bonding and crack propagation is one of the mayor concerns regarding this technology at the moment.

## 8.2 Potential and benefits

As mentioned in the beginning of chapter 7.5, it was the idea of transferring P&A from rigs to ships that became the main idea and driver behind this technology. The basic idea at the moment is that a tool is lowered on wireline by using a vessel that has that kind of capability. A light well intervention vessel will suffice. There is also a possible scenario that is not worked out yet that involves pumping the mixture as a fluid. CT, also from a vessel could in that case become a viable option. The advantages performing P&A from a ship compared to a rig are discussed in chapter 6.

Some other benefits by employing this technology also become clear by taking a look at the diagram below.



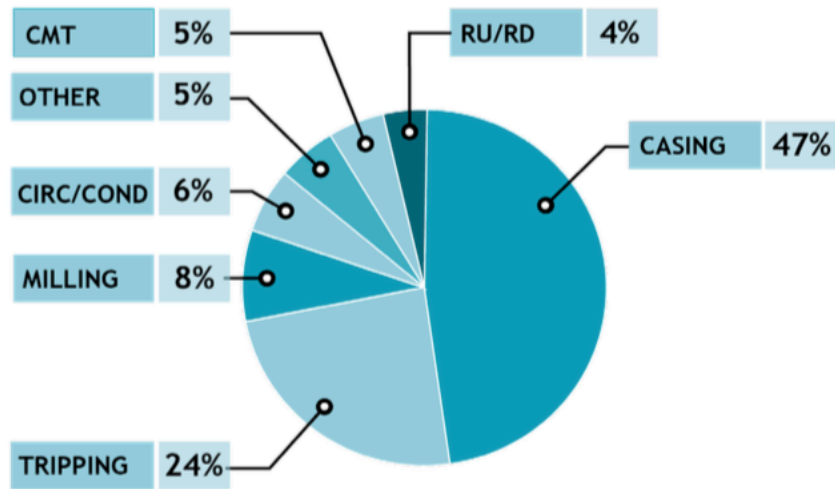

Source: Statoil

Figure 30: Time consumption during P&A operations (Interwell, 2016c)

The circle diagram is part of a study by Statoil looking into what parts of a P&A operation that occupies most of the time consumption. Clearly the predominant part is dealing with casing. Casing implies cutting and pulling of steel to either gain access behind the casing or pulling it to the surface. Tripping involves running tools in and out of the well. Milling takes up approximately 8 % of the time. If you add milling, casing and a good chunk of the tripping time because behind that time lies issues in conjunction with milling and casing, very little time is left actually doing the P&A job. Interwell proposes that by using their P&A solution, if proven successful, cuts this cake in half. Much of the time reduced comes as a direct result of not needing to convey and start cutting or pulling operations of casing. Also, since the exothermic reaction carries with it its own plug that is formed by the products of the reaction, pumping cement wont become necessary either. If the technology were used to remove elements that otherwise would require cutting or milling in the casing, no swarf is generated. Swarf not only increases the time spent on a P&A operation, it also represent a HSE-concern and has the potential of damaging equipment in the well as pointed out previously.

The potential is therefore to perform P&A faster and from vessels compared to rigs. This suggests there will be a considerable day rate saving as well as cost savings from accomplishing the operation quicker.

Another benefit is the characteristics of the plug that is formed compared to that of a cement plug. Research by OR comparing cement and the plug created by the exothermic reaction coupled with/or without diluents revealed a number of interesting findings;

- The plug is developed within a short time frame (minutes) and also reaches its full mechanical design strength within hours. Less than five hours is claimed by OR, but the specifics concerning the tests is not fully detailed, but that the plug length was five meter.
- The compressive strength of the plug is stronger than cement (three times stronger in some tests). Also, tests have displayed good bonding, which good allow for shorter plug lengths in the future. Off course this depends on/ and if requirements and guidelines are changed.
- Well suited for HP/HT environments. (Lowry, 2015)

### 8.2.1 Pilot wells

The ultimate test of this technology takes place in Alberta, Canada in august this year. Two wells are acquired and Centrica is a partner involved in this phase of the project. Centrica has thousands of wells in Canada and also a smaller footprint on the NCS. These are land wells and Interwell plan to do a number of land well tests to learn and verify the technology properly before moving on to offshore testing. The idea is to get this done within a few years if everything goes according to plan (Interwell, 2016c).

After the testing is completed the wells are verified in stages. First, the plug is tagged and a positive test is performed to see if the plug holds. The test is run upwards to fracture

pressure. Then a negative inflow test follows adjusted to 70 bar differential pressure. Xmas tree is then put back on the well and pressure is monitored for two months. Pressure increase means that the plug is leaking. A CBL is run before and after the barrier is in place for inspection purposes and also to learn if the exothermic reaction has created damages or anything of that nature. A camera is also run to inspect the different annuli and finally geophones is placed to register possible seismic events either created by the reaction or if something happen in the area that could interfere with the test.

### 8.3 Optimism

There is broad enthusiasm concerning this technology within the petroleum industry in Norway I have found out speaking to various people in the industry. Below are some of the comments from people with several years experience and knowledge from the industry.

Steinar Strøm said he is optimistic regarding the technology and that it could have large implications if it proves successful. *“ It is very clear that, if we can construct barriers by using this technology, it will have an enormous impact on P&A operations. Transferring the work from rig to intervention-based solutions makes it a very interesting option moving forward. There are some challenges of course, like the length of the plugs etc., but my general feeling is that this technology looks promising. Another thing with extreme technologies like the one mentioned is that it could take some time before it is ready for commercialization, so in the meantime we have to work on improving current technology and procedures.”*

Martin Straume, lead P&A engineer in BP, shares much of the same enthusiasm as Strøm. *“ I have high hopes for this concept. Nothing would be better than achieving a cross-sectional barrier, stretching from one side of the formation over to the other, without the use of a rig. There exists a considerable cost saving potential within a technology like that. I also think the concept is fascinating in the way that it is based on natures own*

*mechanics. Because we know that lava generates close to an impermeable mass after it has cooled down and solidified. So, if we can copy that, it is an excellent concept. Moving large parts of the P&A scope over from the rig to vessels is without a doubt the way to go. Large casing strings could pose problems for this technology, because of the volumes involved. However, time will tell regarding those issues.”*

Steinar Edholm has several years experience as a drilling engineer and P&A team leader in BP, also he points to this technology as promising. “ *Yes, I think this technology looks promising. As the other guys mentioned, you could use an approach that is not based on rigs. Besides, not having to remove so much steel from the well is also a mayor benefit. I think it is important to focus on technologies that have the capabilities to turn things around. CoP mentioned in the press last week that improving current technology wont decrease costs enough. I concur with that and think there should be an increased focus on new technology as well as improving the technology that still have to be used a little while longer.”*

## CHAPTER 9. CONCLUSION

A new way of setting P&A plugs are presented in this thesis. The technology is based on lowering an exothermic reaction into a desired plugging depth in the wellbore. After the reaction has been ignited, it turns the products and other elements in the wellbore into a permanent barrier.

Several ideas and concepts from Interwell and OR are presented as proposals how this technology can be achieved.

The technology faces several challenges, but there are also considerable benefits that have people in the P&A community optimistic concerning the technology in question.

Two pilot wells (Interwell) are scheduled for August and should that prove to be a success, the technology will go through further testing. So, the conclusion, and my last words ever written for the UiS are; only time has the answers to all our questions. Also, whether or not this technology upholds to be the drastic measure that can prove to be the answer for cutting costs in P&A operations.

## 1. REFERENCES

- Albertsen, L. (2016). Technology update.
- Archerwell. (2015). Modular Rig. Retrieved from [http://offshore.no/sak/267379\\_veteraner-vil-bygge-ny-pluggerigg-for-norsk-sokkel](http://offshore.no/sak/267379_veteraner-vil-bygge-ny-pluggerigg-for-norsk-sokkel)
- Bjørsvik, B. T. (2015). Skal spare industrien for P&A –milliarder. *Petro.no*. Retrieved from <http://petro.no/skal-spare-industrien-for-pa-milliarder/27768>
- Board, A. E. U. (2012). No fracking way. Retrieved from <http://www.nofrackingway.us/2012/11/13/fracking-lies-and-the-lying-liars-that-tell-them/gas-migration-paths/>
- Britannica. (2016). Surfactant. Retrieved from <http://global.britannica.com/science/surfactant>
- Chemistry, N. F. a. t. R. S. o. (2015). The thermite reaction. Retrieved from <http://www.rsc.org/learn-chemistry/resource/res00000724/the-thermite-reaction?cmpid=CMP00005969>
- Cripps, K. (2015). Best country in the world to live? Still Norway, according to the U.N. *CNN*. Retrieved from <http://edition.cnn.com/2015/12/16/travel/undp-most-liveable-country/>
- D-010, N. (2013). Well integrity in drilling and well operations. *Well integrity in drilling and well operations.*, 4.
- Duguid, A., & Wohletz, K. HIGH PERFORMANCE CERAMIC PLUGS FOR BOREHOLE SEALING.
- Dunn, W. E. L. a. S. D. (2014). Well sealing via thermite reactions. Retrieved from <https://www.google.us/patents/US9228412>
- Dunn, W. E. L. S. D. (2014). Well sealing via thermite reactions Retrieved from <http://www.google.com/patents/WO2015116261A1?cl=en>
- Eng., C. (2013). Vessel-Based Suspended Well Abandonment. *Norwegian Plug & Abandonment Forum (PAF) Workshop, Norwegian Oil and Gas Association* .
- Exchange, L. M. (2016). Official prices. Retrieved from <http://www.lme.com>
- Ferg, T. (2013). Developments in non-traditional plug and abandonment methods. *Norwegian Plug & Abandonment Forum (PAF) Workshop*. Retrieved from [https://www.norskoljeoggass.no/Global/Presentasjoner/PAF\\_seminar2013/4-ConocoPhillips-Thomas-Ferg.pdf](https://www.norskoljeoggass.no/Global/Presentasjoner/PAF_seminar2013/4-ConocoPhillips-Thomas-Ferg.pdf)
- Fjelde, K. K. (2013). PET605 Well intervention and PP&A *University of Stavanger*.
- Frafjord, E. (2016). Hvem kan løse milliardgaten for ConocoPhillips. Retrieved from [http://offshore.no/sak/268840\\_hvem-kan-lose-milliardgaten-for-conocophillips](http://offshore.no/sak/268840_hvem-kan-lose-milliardgaten-for-conocophillips)
- Gurstelle, W. (2014). Make thermite - the invention that welded the world's modern railways. *Make*. Retrieved from <http://makezine.com/projects/make-39/hans-goldschmidt-and-the-invention-of-thermite/>
- Haga, J. (2014). Rigless P&A of Subsea Wells- Experiences and improvements. *Norwegian Plug & Abandonment Forum (PAF) Workshop*.

- Handal, C. (2014). Abandonment of obsolete wells and installations on the Norwegian continental shelf. A study into the magnitude of the technical and economic challenges.
- Helixesg. (2013). Modu Q 4000. Retrieved from <http://www.helixesg.com/well-intervention/intervention-assets/q4000/>
- Hughes, B. Mechanical pipe cutter. Retrieved from <http://www.bakerhughes.com/products-and-services/evaluation/cased-hole-wireline-services/pipe-recovery/mechanical-pipe-cutter-mpc>
- Hughes, B. (2016). AutoTrak X-treme Rotary Steerable System. *Baker Hughes*. Retrieved from <http://www.bakerhughes.com/products-and-services/drilling/drilling-services/directional-drilling-services/rotary-steerable-systems/autotrak-x-treme-rotary-steerable-system>
- IndexMundi. (2016). 2016 Stock market prices. Retrieved from <http://www.indexmundi.com/commodities/>
- Intervention, H. (2014). HydraWash. Retrieved from <http://www.hydrawell.no/products/hydrawash>
- Interwell. (2016a). HEX. Retrieved from <http://www.interwell.com/high-expansion-retrievable-bridge-plug/category601.html>
- Interwell. (2016b). Rig-less plug and abandonment. Retrieved from <http://www.interwell.com/plug-abandonment/category538.html>
- Interwell. (2016c). Thermic reaction. Retrieved from <https://showcase.itfenergy.com/assets/2016-Presentations/Wells-/Well-PA-Lars-Albertsen-Interwell-ITF-Technology-Showcase.pdf>
- ISO. (2014). Well integrity Retrieved from <https://www.iso.org/obp/ui/-iso:std:iso:ts:16530:-2:ed-1:v1:en>
- Janbu, A. F. (2016). Cutting well P&A costs by using DNV GL's new Recommended Practice. *DNV GL*. Retrieved from <https://www.dnvgl.com/news/cutting-well-p-a-costs-by-using-dnv-gl-s-new-recommended-practice-64184>
- Krauss, C. (2016). Oil Prices Explained: Signs of a Modest Revival. *The New York Times*. Retrieved from [http://www.nytimes.com/interactive/2016/business/energy-environment/oil-prices.html?\\_r=0](http://www.nytimes.com/interactive/2016/business/energy-environment/oil-prices.html?_r=0)
- Lende, G. (2012). Cement technology for P&A. Retrieved from [https://www.norskoljeoggass.no/Global/Presentasjoner/PAF Workshop/7-Halliburton - Gunnar Lende Cementing for PWA - PAF june 2012 R3.pdf](https://www.norskoljeoggass.no/Global/Presentasjoner/PAF%20Workshop/7-Halliburton%20-%20Gunnar%20Lende%20Cementing%20for%20PWA%20-%20PAF%20june%202012%20R3.pdf)
- Lender, W. (2011). Railroad thermite welding. *Youtube*. Retrieved from <https://www.youtube.com/watch?v=5uxsFglz2ig>
- Lowry, B. (2015). Ceramic Plugs for Well Sealing Applications.
- Maritime. (2016). Rigger i Nord-Europa. Retrieved from <http://maritime.no/rigg/>
- Moeinikia, F., Fjelde, K. K., Saasen, A., Vrålstad, T., & Arild, O. (2014). A Probabilistic Methodology To Evaluate the Cost Efficiency of Rigless Technology for Subsea Multiwell Abandonment. *SPE Production & Operations*.
- Nissen-Meyer, J. (2015). «Oppvasken» på norsk sokkel kan koste over 500 milliarder. *E24*. Retrieved from <http://e24.no/energi/oppvasken-paa-norsk-sokkel-kan-koste-over-500-milliarder/23473790>

- Norway, P. S. A. (2011a). The Activities Regulations. Retrieved from <http://www.psa.no/activities/category399.html> - p88
- Norway, P. S. A. (2011b). The Facilities Regulations. Retrieved from <http://www.psa.no/facilities/category400.html> - p48
- Norway, P. S. A. (2016). Role and area of responsibility. Retrieved from <http://www.psa.no/role-and-area-of-responsibility/category916.html>
- Nåmdal, S. (2011). Decommissioning of offshore installations. Retrieved from [http://www.npd.no/Global/Engelsk/3 - Publications/Reports/endelig avvikling rapport engelsk.pdf](http://www.npd.no/Global/Engelsk/3-Publications/Reports/endelig_avvikling_rapport_engelsk.pdf)
- Oudemans, P., ter Avest, D., Grodal, E., Asheim, H., & Meissner, R. (1994). *Bull Heading To Kill Live Gas Wells*. Paper presented at the European Petroleum Conference.
- Ouyang, S., & Daemen, J. (1996). Performance of bentonite and bentonite/crushed rock borehole seals *Sealing of boreholes and underground excavations in rock* (pp. 65-95): Springer.
- Petrowiki. (2012). Coiled tubing equipment design. Retrieved from [http://petrowiki.org/File%3ADevol2\\_1102final Page 692 Image 0001.png](http://petrowiki.org/File%3ADevol2_1102final_Page_692_Image_0001.png)
- Reason, J. (1990). *Human error*: Cambridge university press.
- Regjeringen.no. (2013). Norway's oil history in 5 minutes. Retrieved from <https://www.regjeringen.no/en/topics/energy/oil-and-gas/norways-oil-history-in-5-minutes/id440538/>
- report, H. d. (2015). Statistical annex. *United Nations*. Retrieved from [http://hdr.undp.org/sites/default/files/hdr\\_2015\\_statistical\\_annex.pdf](http://hdr.undp.org/sites/default/files/hdr_2015_statistical_annex.pdf)
- Sachs, G. (2014). An Annotated History Of Oil Prices Since 1861. *Business insider*. Retrieved from <http://www.businessinsider.com/annotated-history-crude-oil-prices-since-1861-2014-12?r=US&IR=T&IR=T>
- Skjold, M. (2013). Method of well operation. Retrieved from <http://www.google.com/patents/WO2013135583A2?cl=en>
- Skjold, M. (2015). Method of well operation. *Fresh patents*. Retrieved from <http://images1.freshpatents.com/imageviewer/20150034317-p20150034317>
- Sorheim, O.-I., Ribesen, B. T., Sivertsen, T. E., Saasen, A., & Kanestrom, O. (2011). *Abandonment of Offshore Exploration Wells using a Vessel Deployed System for Cutting and Retrieval of Wellheads*. Paper presented at the SPE Arctic and Extreme Environments Conference and Exhibition.
- Spieler, T. Ø. J. O. (2015). Plug-and-abandonment-status-on-the-Norwegian-continental-shelf. *UiS*.
- Standard, N. (2015). Norsok Standards. Retrieved from <https://www.standard.no/en/sectors/energi-og-klima/petroleum/norsok-standards/- .V1aIAWPW802>
- Stangeland, G. (2016). Veteraner vil bygge ny pluggerrigg for norsk sokkel. *Offshore.no*. Retrieved from [http://offshore.no/sak/267379\\_veteraner-vil-bygge-ny-pluggerrigg-for-norsk-sokkel](http://offshore.no/sak/267379_veteraner-vil-bygge-ny-pluggerrigg-for-norsk-sokkel)
- Statoil. (2011). Applicable laws and regulations. Retrieved from <http://www.statoil.com/annualreport2011/en/ouoperations/applicablelawsandregulations/pages/applicablelawsandregulations.aspx>



- Statoil. (2012). LWI and Temporary P&A Activity on TOGI Wells. *Norwegian Plug & Abandonment Forum (PAF) Workshop*.
- Statoil. (2013). Statoil and Aker Solutions cancel Cat B rig contract. Retrieved from [http://www.statoil.com/en/NewsAndMedia/News/2013/Pages/24Jun\\_CatB.aspx](http://www.statoil.com/en/NewsAndMedia/News/2013/Pages/24Jun_CatB.aspx)
- Straume, M. (2014). Need for new and cost effective P&A technology. *Plug and abandonment forum*. Retrieved from [http://www.norskoljeoggass.no/Global/PAF\\_Seminar\\_2014/1 - Need for new and cost effective P og A technology - PAF - Martin Straume.pdf](http://www.norskoljeoggass.no/Global/PAF_Seminar_2014/1_-_Need_for_new_and_cost_effective_P_og_A_technology_-_PAF_-_Martin_Straume.pdf)
- Taraldsen, L. (2014). Det kan ta 15 rigger 40 år å plugge alle brønnene på sokkelen. *Teknisk Ukeblad*. Retrieved from <http://www.tu.no/artikler/det-kan-ta-15-rigger-40-ar-a-plugge-alle-bronnene-pa-sokkelen/230974>
- Tettero, F., Barclay, I., & Staal, T. (2004). *Optimizing Integrated Rigless Plug and Abandonment-A 60 Well Case Study*. Paper presented at the SPE/ICoTA Coiled Tubing Conference and Exhibition.
- Torgauten, A. O. A. (2013). Classifying and Defining Operational and Organizational Aspects of Barriers for the Offshore Oil and Gas Industry.
- UK, O. A. G. (2015). Guidelines on well abandonment cost estimation. (5).
- UK, O. G. (2012). Guidelines on qualification of materials for the suspension and abandonment of wells.
- Vignes, B. (2011). "Contribution to well integrity and increased focus on well barriers from a life cycle aspect". (no. 148), University of Stavanger, Faculty of Science and Technology, Stavanger.
- Vudovich, A., Chin, L., & Morgan, D. (1988). *Casing deformation in Ekofisk*. Paper presented at the Offshore Technology Conference.
- Weatherford. (2016). Reduce rig time and costs with a rig-less approach to offshore well intervention and abandonment. Retrieved from <http://www.weatherford.com/en/products-services/well-construction/well-abandonment-and-intervention-services/rig-free-light-duty-pulling-and-jacking-unit>
- Weltzin, T. (2012). Statfjord A PP&A. *Norwegian Plug & Abandonment Forum (PAF) Workshop*.
- Wikipedia. (2014). Chilled margin. Retrieved from [https://en.wikipedia.org/wiki/Chilled\\_margin](https://en.wikipedia.org/wiki/Chilled_margin)
- Wikipedia. (2016a). Magma. *Wikipedia*. Retrieved from <https://en.wikipedia.org/wiki/Magma>
- Wikipedia. (2016b). Steam explosion. *Wikipedia*. Retrieved from [https://en.wikipedia.org/wiki/Steam\\_explosion](https://en.wikipedia.org/wiki/Steam_explosion)
- Wikipedia. (2016c). Swiss cheese model. Retrieved from [https://en.wikipedia.org/wiki/Swiss\\_cheese\\_model](https://en.wikipedia.org/wiki/Swiss_cheese_model)
- Wikipedia. (2016d). Thermite. Retrieved from <https://en.wikipedia.org/wiki/Thermite>
- Wikipedia. (2016e). Tungsten. *Wikipedia*. Retrieved from <https://en.wikipedia.org/wiki/Tungsten>
- Wishahy, M. A., & Brekke, J. N. (2012). Method and apparatus for improving the lateral support provided by the legs of a jack-up drilling rig: Google Patents.

Øia, J. O. S. T. M. (2015). P&A - Well Statistics. *Plug & Abandonment Seminar*.  
Retrieved from [http://www.norskoljeoggass.no/Global/PAF seminar 2015/03 -  
Well Statistics UiS Students Spieler og %C3%98ia.pdf?epslanguage=no](http://www.norskoljeoggass.no/Global/PAF_seminar_2015/03_-_Well_Statistics_UiS_Students_Spieler_og_%C3%98ia.pdf?epslanguage=no)