



Universitetet  
i Stavanger

FACULTY OF SCIENCE AND TECHNOLOGY

## MASTER'S THESIS

Study programme/specialisation: Engineering Structures and Materials Mechanical Systems	Spring semester, 2018  Confidential
Author: Øystein Refsland Andreassen	..... <i>Øystein R. Andreassen</i> ..... (signature of author)
Programme coordinator: Prof. Dimitrios Pavlou Supervisor(s): Dr. Idriss El-Thalji (UIS), Torbjørn Gjerde (ConocoPhillips)	
Title of master's thesis: Reliability centred maintenance of Electric Overhead Traveling (EOT) cranes installed in the well intervention area: A case study for ConocoPhillips.	
Credits: 30	
Keywords: Reliability Centered Maintenance Asset Management Material handling machinery Cranes and lifting Weibull analysis NORSOK	Number of pages: .....99 (138).....  +supplemental material/other: ...141...  Stavanger,.....15.06.2018..... date/year

## Acknowledgement

This report is a result of my master thesis work completing the Engineering structures and materials program at the University of Stavanger the spring of 2018.

Despite taking a Master of Science in structural engineering I am glad to be able to do my master thesis work in the subject of Reliability Centred Maintenance.

I would like to express my sincere appreciation to my supervisor Dr. Idriss El-Thalji, whose guidance have been most inspirational, helpful, and instrumental to the successful completion of this master thesis.

My gratitude goes out to ConocoPhillips, for granting me this opportunity and the data needed. In special Torbjørn Gjerde (now working for Petroleum Safety Authority), Morten Birch Emmerhoff and Dr. Sukhvir Panesar for guiding me through SAP, documentation, and thesis review. For our many interesting discussions in the field of material handling and reliability engineering.

At last. To my beloved wife, Pernille Sivesind Thomsen, whose support throughout the whole master program, and especially during the thesis work have been invaluable.

Øystein Refsland Andreassen

## Abstract

Material handling equipment is vital for support functions for oil and gas production facilities. On a production platform, cranes are mounted in several areas. E.g. for handling load between supply vessels and platform, and smaller cranes for internal material handling. Lifting of suspended loads on an offshore platform present a significant hazard, the probability of which increases considerably if the crane lacks robust inspection and maintenance routines.

Older cranes on a production facility often do not have inspection and maintenance recommendation from the vendor since these were installed in a time when there was less focus on inspection and maintenance. The recommendations at times are ambiguous or were applicable only for initial one or two years of operations. During the years some of the manufacturers could be acquired by other companies, resulting in discontinuity of the crane model or production line, or the crane model could simply be specially made for the given platform.

In the well intervention area of ConocoPhillips' Ekofisk M four Electric Overhead Travelling (EOT) cranes are installed, two cranes with working load of 25 tonnes and two with working load of 15 tonnes, all manufactured by Dreggen specially made for ConocoPhillips and Ekofisk M. The cranes of interest were installed in 2004 and are almost exclusively used under well intervention campaigns. The campaigns require extensive usage of the cranes for 10 to 15 days every third months.

The given period demands high reliability of the crane, down time in well intervention are not appreciated. Thus, a strict inspection and maintenance regime is needed.

The inspection and maintenance instructions given by Dreggen recommend annual inspection and maintenance. The inspection and maintenance instructions are not aligned to the operational requirements. Few instructions, with little description are given on inspection and maintenance that exceed the annual demand.

A need for further investigation into this subject had presented itself, thus, the problem text was formulated: how can the inspection and maintenance regime be enhanced to facilitate this particular use case?

By utilizing reliability methodology such as Reliability Centred Maintenance (RCM) the cranes were analysed through looking at equipment history, boundary systems, breaking down the equipment structure, defining functions and identifying functional failures, failure modes and effects. Focusing on preserving functions to enhance the Preventive Maintenance (PM) program.

The analysis presented a suggestion to enhance the current PM program to facilitate the particular use case, and some recommendations for further work.

Which in general terms was to live the PM program; implement RCM tasks, monitor, and report results, measure effectiveness and continuously make improvements to the PM program. To do this one will need to focus on preserving functions and identifying failure modes, and failure causes in the reported data.

## Contents

<b>Preface</b>	<b>I</b>
<b>Abstract</b>	<b>II</b>
<b>List of Figures</b>	<b>VI</b>
<b>List of Tables</b>	<b>VI</b>
<b>Abbreviations and definitions</b>	<b>VII</b>
<b>1 Introduction</b>	<b>1</b>
1.1 Problem background . . . . .	1
1.2 Thesis objectives . . . . .	1
1.3 Methodology . . . . .	2
1.4 Project scope and delimitation . . . . .	2
1.5 Thesis outline . . . . .	2
<b>2 Background</b>	<b>4</b>
2.1 ConocoPhillips . . . . .	4
2.2 Ekofisk 2/4 M . . . . .	5
2.3 Well Intervention . . . . .	6
2.3.1 Coiled Tubing . . . . .	6
2.3.2 Wireline . . . . .	8
2.4 Overhead Cranes . . . . .	9
2.5 Dreggen Crane . . . . .	11
<b>3 Theory</b>	<b>12</b>
3.1 Development of maintenance . . . . .	12
3.2 Reliability Centred Maintenance . . . . .	13
3.3 Regulations . . . . .	14
<b>4 Methodology</b>	<b>16</b>
4.1 System selection and information collection . . . . .	17
4.2 System boundary definition . . . . .	18
4.3 System description and functional block diagram . . . . .	18
4.4 System functions and functional failures . . . . .	19
4.5 Failure mode and effects analysis . . . . .	19
4.6 Logic (decision) Tree Analysis . . . . .	22
4.7 Task selection . . . . .	24
4.7.1 Task selection process . . . . .	24
4.7.2 Sanity check . . . . .	27
4.7.3 Task comparison . . . . .	27
<b>5 Data collection</b>	<b>29</b>
5.1 Cranes . . . . .	29
5.1.1 25 T Cranes . . . . .	29
5.1.2 15 T Cranes . . . . .	30
5.2 Component identification . . . . .	31
5.3 Corrective Maintenance . . . . .	31

5.4	Preventive Maintenance . . . . .	32
<b>6</b>	<b>Data analysis and results</b>	<b>34</b>
6.1	25 T Crane 07010 . . . . .	34
6.1.1	System selection and information collection . . . . .	34
6.1.2	System boundary definition . . . . .	36
6.1.3	System description and functional block diagram . . . . .	36
6.1.4	System functions and functional failures . . . . .	38
6.1.5	Failure mode and effects analysis . . . . .	39
6.1.6	Logic Tree Analysis . . . . .	39
6.1.7	Task selection . . . . .	39
6.2	25 T Crane 07015 . . . . .	49
6.2.1	System selection and information collection . . . . .	49
6.2.2	System boundary definition . . . . .	51
6.2.3	System description and functional block diagram . . . . .	51
6.2.4	System functions and functional failures . . . . .	53
6.2.5	Failure mode and effects analysis . . . . .	53
6.2.6	Logic Tree Analysis . . . . .	53
6.2.7	Task selection . . . . .	54
6.3	15 T Crane 07020 . . . . .	63
6.3.1	System selection and information collection . . . . .	63
6.3.2	System boundary definition . . . . .	65
6.3.3	System description and functional block diagram . . . . .	65
6.3.4	System functions and functional failures . . . . .	67
6.3.5	Failure mode and effects analysis . . . . .	67
6.3.6	Logic Tree Analysis . . . . .	67
6.3.7	Task selection . . . . .	68
6.4	15 T Crane 07025 . . . . .	75
6.4.1	System selection and information collection . . . . .	75
6.4.2	System boundary definition . . . . .	77
6.4.3	System description and functional block diagram . . . . .	78
6.4.4	System functions and functional failures . . . . .	79
6.4.5	Failure mode and effects analysis . . . . .	80
6.4.6	Logic Tree Analysis . . . . .	80
6.4.7	Task selection . . . . .	80
<b>7</b>	<b>Discussion</b>	<b>88</b>
7.1	25 T Crane 07010 . . . . .	88
7.2	25 T Crane 07015 . . . . .	90
7.3	25 T Cranes . . . . .	91
7.4	15 T Crane 07020 . . . . .	91
7.5	15 T Crane 07025 . . . . .	92
7.6	15 T Cranes . . . . .	92
7.7	The Ekofisk M Cranes . . . . .	92
7.8	General framework . . . . .	94
<b>8</b>	<b>Conclusion</b>	<b>96</b>
8.1	Recommendations and further work . . . . .	96
	<b>References</b>	<b>98</b>

<b>A</b>	<b>Electric Overhead Traveling crane assembly</b>	<b>I</b>
<b>B</b>	<b>COPSAS' risk matrix</b>	<b>II</b>
<b>C</b>	<b>SAP TAG Structure</b>	<b>III</b>
C.1	TAG No. 07010 . . . . .	III
C.2	TAG No. 07015 . . . . .	VI
C.3	TAG No. 07020 . . . . .	IX
C.4	TAG No. 07025 . . . . .	XI
<b>D</b>	<b>Work Standards</b>	<b>XIII</b>
D.1	WS-19OVER30.M . . . . .	XIII
D.2	WS-19OVER32.M . . . . .	XIV
D.3	WS-19OVER33.M . . . . .	XV
D.4	WS-19OVER45.M . . . . .	XVI
D.5	WS-19OVER46.M . . . . .	XX
D.6	WS-19OVER59.M . . . . .	XXIII
D.7	WS-30MOTO68.E . . . . .	XXIV
<b>E</b>	<b>Analyses</b>	<b>XXV</b>
E.1	25 T Crane 07010 . . . . .	XXV
E.2	25 T Crane 07015 . . . . .	XXV
E.3	15 T Crane 07020 . . . . .	XXV
E.4	15 T Crane 07025 . . . . .	XXV
<b>F</b>	<b>Minutes of meetings</b>	<b>XXVI</b>

## List of Figures

2.1	Ekofisk area (ConocoPhillips 2018g).	5
2.2	Ekofisk 2/4 M (ConocoPhillips 2018g).	6
2.3	Coiled Tubing setup (Paaske 2017).	7
2.4	Wireline setup (Paaske 2017).	9
2.5	Electric Overhead Travelling crane (Bhatia 2012).	10
3.1	Growing expectations of maintenance (Moubray 1997).	12
3.2	An illustration of different approaches to maintenance strategy (Kumar & Kumar 2004).	13
4.1	Pareto diagram example (Tinga 2013).	17
4.2	Equipment-Functional failure matrix example (Smith & Hinchcliffe 2004).	20
4.3	Failure Mode and Effect Analysis example (Smith & Hinchcliffe 2004).	20
4.4	Logic Tree Analysis structure (Smith & Hinchcliffe 2004).	22
4.5	Typical Logic Tree Analysis on form for Step 6 (Smith & Hinchcliffe 2004).	23
4.6	Task selection road map (Smith & Hinchcliffe 2004).	25
4.7	Task selection form (Smith & Hinchcliffe 2004).	26
4.8	Sanity checklist (Smith & Hinchcliffe 2004).	28
4.9	Task comparison (Smith & Hinchcliffe 2004).	28
5.1	25 T EOT Cranes, TAG: 07010 and 07015 (Aibel AS 2011).	30
5.2	15 T EOT Cranes, TAG: 07020 and 07025 (Dreggen Crane AS 2004b).	30
6.1	Notification per priority category 07010.	34
6.2	Pareto diagram for 07010.	35
6.3	Revised pareto diagram for 07010.	35
6.4	Functional block diagram.	37
6.5	Weibull plot for drive chain 07010.	41
6.6	Weibull plot for wire rope 07010.	42
6.7	Weibull plot for push button station 07010.	43
6.8	Weibull plot for limit switch hoist 07010.	44
6.9	Weibull plot for overload switch hoist 07010.	45
6.10	Notification per priority category 07015.	49
6.11	Pareto diagram for 07015.	50
6.12	Revised pareto diagram for 07015.	50
6.13	Weibull plot for gear 07015.	55
6.14	Weibull plot for wire rope 07015.	56
6.15	Weibull plot for anti-collision system 07015.	57
6.16	Weibull plot for limit switch hoist 07015.	58
6.17	Notification per priority category 07020.	63
6.18	Pareto diagram for 07020.	64
6.19	Pareto diagram for hoist system 07020.	64
6.20	Pareto diagram for instrument system 07020.	65
6.21	Weibull plot for wire rope 07020.	70
6.22	Weibull plot for overload switch 07020.	71
6.23	Notification per priority category 07025.	76
6.24	Pareto diagram for 07025.	76
6.25	Pareto diagram for instrument system 07025.	77
6.26	Pareto diagram for hoist system 07025.	77

## List of Tables

4.1	Illustration of correct functional statement (Smith & Hinchcliffe 2004).	19
4.2	Example of functional failures (Smith & Hinchcliffe 2004).	19
4.3	Typical descriptors for failure modes (Smith & Hinchcliffe 2004).	21
5.1	PM program for EOT Cranes (Emmerhoff 2017).	33
6.1	Task comparison 07010 bridge system.	47
6.2	Task comparison 07010 hoist system.	47
6.3	Task comparison 07010 instrument system.	48
6.4	Task comparison 07010 other system.	48
6.5	Task comparison 07010 runway system.	48
6.6	Task comparison 07010 trolley system.	49
6.7	Task comparison 07015 bridge system.	60
6.8	Task comparison 07015 hoist system.	61
6.9	Task comparison 07015 instrument system.	62
6.10	Task comparison 07015 runway system.	62
6.11	Task comparison 07015 trolley system.	63
6.12	Task comparison 07020 bridge system.	73
6.13	Task comparison 07020 hoist system.	73
6.14	Task comparison 07020 instrument system.	74
6.15	Task comparison 07020 other system.	75
6.16	Task comparison 07020 runway system.	75
6.17	Task comparison 07020 trolley system.	75
6.18	Task comparison 07025 bridge system.	84
6.19	Task comparison 07025 hoist system.	85
6.20	Task comparison 07025 instrument system.	86
6.21	Task comparison 07025 other system.	87
6.22	Task comparison 07025 runway system.	87
6.23	Task comparison 07025 trolley system.	87

## Abbreviations and definitions

- **Availability** – Availability of an item to be in a state to perform a required function under given conditions at a given instant of time, or in average over a given time interval, assuming that the required external resources are provided.
- **BOP** – Blow Out Preventer.
- **CD** – Condition-Directed (PM tasks).
- **CM** – Corrective Maintenance.
- **COP** – ConocoPhillips.
- **CT** – Coiled Tubing.
- **CTD** – Coiled Tubing Drilling.
- **DHSV** – Down Hole Safety Valve.
- **DNV** – Det Norske Veritas (Now: DNVGL).
- **EOT** – Electrical Overhead Traveling cranes.



- **FC** – Failure Cause.
- **FEM** – European Material Handling Federation.
- **FF** – Failure finding (PM Tasks).
- **FM** – Failure Mode.
- **FMEA** – Failure Modes and Effect Analysis.
- **FMECA** - Failure Modes, Effect and Criticality Analysis.
- **GA** – General Arrangement (Drawing).
- **HPU** – Hydraulic Power Unit.
- **HSE** – Health, Safety and Environment.
- **IOI** – Item of interest.
- **JB** – Junction Box.
- **LTA** – Logic (decision) Tree Analysis.
- **MI** – Maintenance Item.
- **MP** – Maintenance Plan.
- **MRB** – Manufacturers Record Book.
- **MTBF** – Mean Time Between Failure.
- **NCS** – Norwegian Continental Shelf.
- **NPD** – Norwegian Petroleum Directorate.
- **OEM** – Original Equipment Manufacturer.
- **P&ID** – Piping & Instrument Diagram.
- **PM** – Preventive Maintenance.
- **RCD** – Residual-Current Device.
- **RCM** – Reliability Centred Maintenance.
- **Reliability** – Ability of an item to perform a required function under given conditions for a given time interval.
- **RTF** – Run-To-Failure.
- **SAP** – ERP system plant management used by ConocoPhillips.
- **SWBS** – System Work Breakdown Structure.
- **SWOT** – Strength Weaknesses Opportunities Threats.
- **TD** – Time-Directed (PM Tasks).
- **TL** – Task List.
- **WL** – Wireline.
- **WS** – Work Standard.

# 1 Introduction

## 1.1 Problem background

Material handling equipment is vital for support functions for oil and gas production facilities. On a production platform, cranes are mounted in several areas. E.g. for handling load between supply vessels and platform, and smaller cranes for internal material handling. Lifting of suspended loads on an offshore platform present a significant hazard, the probability of which increases considerably if the crane lacks robust inspection and maintenance routines.

Older cranes on a production facility often do not have inspection and maintenance recommendation from the vendor since these were installed in a time when there was less focus on inspection and maintenance. The recommendations at times are ambiguous or were applicable only for initial one or two years of operations. During the years some of the manufacturers could be acquired by other companies, resulting in discontinuity of the crane model or production line, or the crane model could simply be specially made for the given platform.

In the well intervention area of ConocoPhillips' Ekofisk M four Electric Overhead Travelling (EOT) cranes are installed, two cranes with working load of 25 tonnes and two with working load of 15 tonnes, all manufactured by Dreggen specially made for ConocoPhillips and Ekofisk M.

The cranes were installed in 2004 and are almost exclusively used under well intervention campaigns. The campaigns require extensive usage of crane for 10 to 15 days in every third months. Meaning that the cranes will be inactive in two months and then extensively used. The risk for a hazardous situation increase if the functions of crane are not verified prior to usage and the cranes are not properly inspected and maintained at regular intervals. During the well intervention campaign period, the cranes are used almost all day and night by well intervention operators who have no ownership to the cranes. Maintenance are done by technicians who do not use the cranes.

The inspection and maintenance instructions given by Dreggen recommend annual inspection and maintenance. The inspection and maintenance instructions are not aligned to the operational requirements. Few instructions, with little description are given on inspection and maintenance that exceed the annual demand.

## 1.2 Thesis objectives

The special use case presented in the problem background together with today's inspection and maintenance regime; the sum of inspection and maintenance applied to the cranes. The main objective of the thesis is to answer the research question:

*How could the inspection and maintenance regime be enhanced to facilitate this particular use case?*

Sub-objectives of the thesis are:

1. Give recommendations for new or revised Preventive Maintenance (PM) program for the

two 25 tonnes and two 15 tonnes EOT cranes.

2. Use the basis of work done on the EOT cranes to discuss if it could be used as a framework to enhance inspection and maintenance on general cranes, hoists and winches on offshore installations.

### 1.3 Methodology

The thesis work is driven as a case study approach: a case study of performed maintenance on the EOT cranes, by comparing the current PM Programs with the analysis, identifying gaps and suggesting improvements, using Reliability Centred Maintenance (RCM) methodology to enhance and align the inspection and maintenance program to operational requirements, through favouring safety functions and preserving functions. The methodology is including Failure Mode and Effect Analysis (FMEA), and tools such as System Work Breakdown Structure (SWBS) and Logic (decision) Tree Analysis (LTA).

### 1.4 Project scope and delimitation

The project is limited to case studies of the four cranes mentioned in the problem background, the machine specific material is made by the manufacturer and contractor and supplied to ConocoPhillips. Data for use and equipment history are supplied by ConocoPhillips. Other cranes used by other operators are not considered.

### 1.5 Thesis outline

The thesis is organized in 8 chapters and 6 appendix chapters. Each chapter will have an introduction text, explaining the content and purpose of the actual chapter. Under is an overview of the chapters, and the content in each chapter:

1. The Introduction chapter are introducing the problem background, thesis objectives, methodology and limitation of thesis.
2. The Background chapter are presenting background information about the operator ConocoPhillips, platform Ekofisk M, general information about well intervention, information about overhead traveling cranes in general, and background information about Dreggen Crane.
3. The theory chapter contains the relevant theory for the thesis.
4. The methodology chapter contains the relevant methodology for analysis.
5. The data collection chapter contains information about the data collection, and processing of data for analysis.
6. The analysis chapter contains the analysis which are performed and the results.
7. The discussion chapter contains the discussion of results versus the objective and sub-objectives stipulated in the thesis objective section.
8. The conclusion chapter contains the thesis conclusion and some recommendation for further work.

In the appendices one can find a spider diagram of the system break down of the cranes, ConocoPhillips' risk matrix, The TAG structure from SAP, the relevant Work Standards, and Minutes of Meeting. A section is made for the analysis, this is only available in a separate document.

## 2 Background

This chapter contains background information about ConocoPhillips, Ekofisk M, Well Intervention, Overhead travelling cranes, EOT cranes with the main systems and the subsystems EOT crane assemblies will be divided into for the case study analysis, and Dreggen Crane, the crane manufacturer. The purpose is to give the reader some background about the operator and platform, as well as the area and use of the cranes, and at last, the crane manufacturer.

### 2.1 ConocoPhillips

Conoco Inc. was an American oil company founded in 1875 in Ogden, Utah as Continental Oil and Transportation Co. The company was a coal, oil, kerosene, grease and candle distributor. Phillips Petroleum Company was an oil and gas company founded in 1917 in Bartlesville, Oklahoma by L.E. Phillips and Frank Phillips.

ConocoPhillips were the result of a merger between Conoco Inc. and Phillips Petroleum in 2002. ConocoPhillips later acquired Burlington resources. ConocoPhillips headquarters are located in Houston, Texas.

ConocoPhillips focuses solely on exploration for, developing and producing oil and gas globally. Today the company are one of the world's biggest oil and gas companies and has about 11,600 employees in 17 different countries (ConocoPhillips 2018f).

In 1959, after the discovery of the largest gas field in Europe, the Groningen gas field. The international oil companies started to take an interest in the Norwegian Continental Shelf (NCS), which was not defined at this time. In October 1962, Phillips Petroleum Company sent a letter to the authorities of Norway, asking for permission to get a license for the sole rights of oil exploration on the Norwegian parts of the North Sea.

In 1963 the Norwegian government proclaimed the ownership of the NCS, and by a new law the landowner, Norway could issue licenses for exploration and production of hydrocarbons. Finally, in 1965 the first licensing round was advertised, and resulted in the awarding of 22 exploration and production licenses for 78 blocks to companies or groups of companies (Regjeringen 2016).

The Ekofisk field; which would show to be one of the largest oil fields ever discovered offshore, was a part of the first licensing round and was discovered in 1969. The production started in 1971 operated by Phillips Petroleum Company, and today ConocoPhillips is one of the largest foreign operators of the NCS. ConocoPhillips is operator of the fields in the Ekofisk-area, with an ownership part of 35,11% in the fields Ekofisk, Eldfisk and Embla. ConocoPhillips is a partner in the fields: Heidrun, Alvheim, Visund, Grane, Oseberg and Troll (ConocoPhillips 2018g).

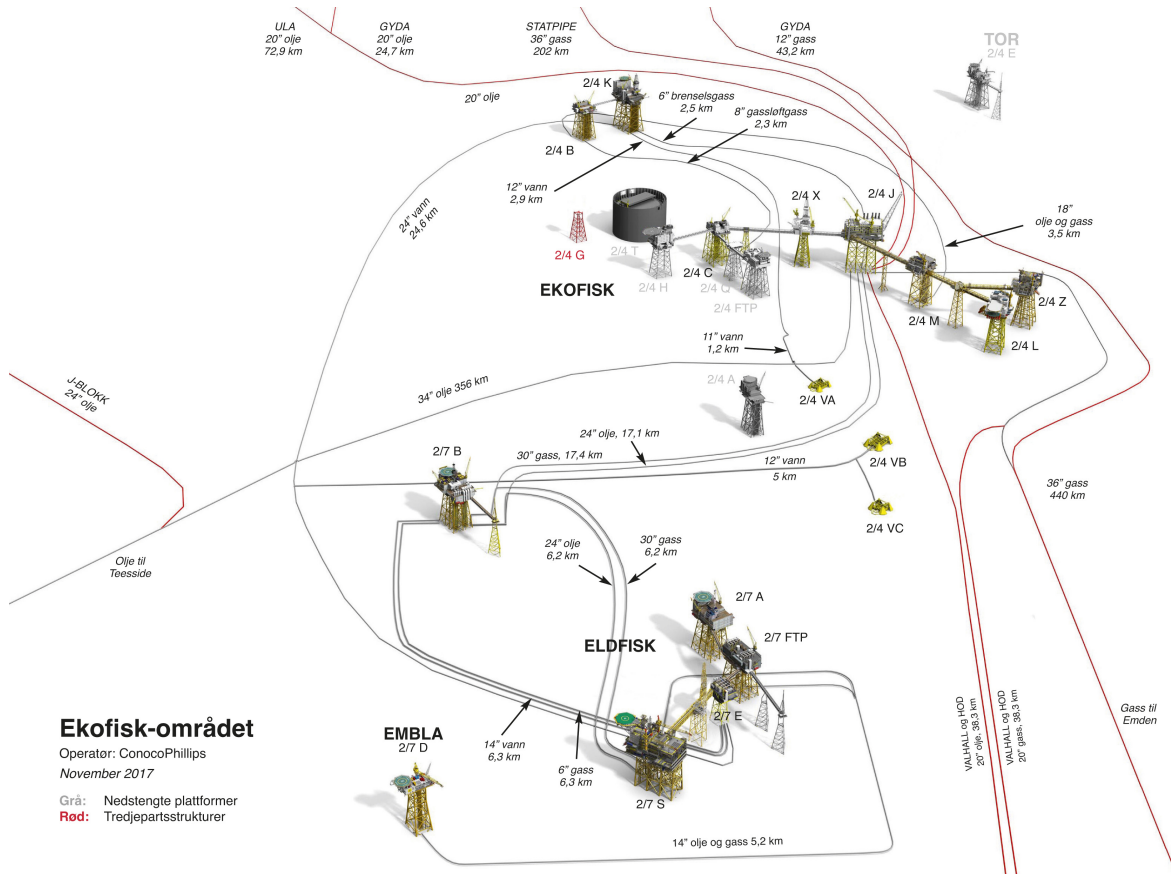

Figure 2.1: Ekofisk area (ConocoPhillips 2018g).

## 2.2 Ekofisk 2/4 M

Ekofisk 2/4 M, hereafter called Ekofisk M, is a combined production and process platform which is remotely operated from Ekofisk 2/4 J. Ekofisk M came into operation in 2005 and has a capacity of 30 wells. One of the wells is used for re-injection of cuttings. Drilling and well activities are done by a hired drilling rig.

Ekofisk M is a point of connection between Ekofisk 2/4 L and Ekofisk 2/4 Z, which was installed in 2013 (ConocoPhillips 2018g).

The area where the cranes which are the focus of this thesis are installed on Ekofisk M is the well intervention area, where maintenance and modification to the wells are done.



**Figure 2.2:** Ekofisk 2/4 M (ConocoPhillips 2018g).

## 2.3 Well Intervention

The definition of well intervention is to lead equipment down in oil and gas wells for surveillance, control, maintenance or optimization of production or injection. Intervention is done by ordinary drilling rig, by snubbing, coiled tubing or wireline (PTIL 2015).

Most commonly the surface equipment consists of coiled tubing or wireline. On Ekofisk M the well intervention operations are done through hatches on the well intervention deck.

The well intervention rig consists of additional barrier elements which is used to replace the barriers that are being taken out of service during the operation. In total the well intervention rig consists of a lot of equipment which has to be placed on the same deck in order for the operator to have control over the well (Paaske 2017). The two main setups: Coiled Tubing and Wireline, will be further explained in the next sections.

### 2.3.1 Coiled Tubing

Coiled Tubing (CT) is a long pipe which is rolled onto a drum. The pipe or tubing is used as a working string for well maintenance and drilling. This operation demands a large quantity of hydraulically operated topside equipment and topside barrier equipment. Coiled Tubing Drilling (CTD); drilling by coiled tubing, is not common on the NCS.

The upside of using CT compared to wireline (WL) is the possibility to circulate liquid into



the well through the coiled tubing. CT is stronger compared to wireline. Thus, it can hold larger tools. Typical operations for using CT:

- Acid stimulation of lime formations.
- Maintenance and washing of the wells inside.
- Perforation of the well.
- Start-up of the well with light liquid.
- Installation of completion equipment.
- Packing of gravel.
- Fishing operations.
- Drilling.



**Figure 2.3:** Coiled Tubing setup (Paaske 2017).

The equipment needed for CT operations depends on the operation. The start of a basic CT setup will be a Hydraulic Power Unit (HPU) for powering the reel, injector and barriers, a control unit and a reel for the coiled tubing. Where the reel has a connection for a hose (to deploy liquid through the tubing) and an arm for guiding the tube. The reel is used for holding some back tension on the tubing, the unit feeding the coiled tubing down the well is called a coiled tubing injector, which is the next component. The coiled tubing injector is made up from hydraulic motors running several grippers, holding on to the tube and running it either down in the well or out of the well.

After the coiled tubing injector two independent barriers (strippers) are installed. The upper stripper is always closed against the coiled tubing when it is down in the well. This stripper is used to prevent buckling as well. The secondary stripper is only in use if the upper one is un-



der maintenance. After the strippers the Blow Out Preventer (BOP) are installed and mounted directly on the well adapter (Paaske 2017).

### 2.3.2 Wireline

Well intervention by wireline is mainly used for maintenance, fishing, and logging operations. Wireline contributes to maintenance and increases production of oil and gas from the wells on the NCS.

A typical wireline operation demands a large quantity of topside equipment. The equipment setup is dependent on the well which the work is done on. In general wireline operation will demand an operations container, a wireline winch, an HPU, a grease/BOP-pressure control unit, a wireline mast, and several valves: Safety head, BOP, lubricator, tool catcher, and stuffing box among some.

The typical operations for using a wireline is:

- Logging of cement.
- Logging of reservoir formation.
- Fishing for lost equipment.
- Well maintenance.
- Installation of seals and plugs.
- Replacing gas lift valves.
- Changing Down Hole Safety Valve (DHSV).

Wireline operations are performed with either a braided wire, braided electric cable or a slick line. The operation performed will have an impact on the chosen line.

Slick line is used for simple, light operations and a braided line is used for heavier operations. The braided electric cables are used when there is a need for communication between topside and downhole. There is a large difference between the barrier units for the different wirelines. The slick line is the easiest to use as it is faster to setup both the primary barrier and the BOP for the slick line because of the construction; it is a solid string. The braided cable, both electric cable and the braided wire needs more pulling force. The braided wire needs both a pressurized primary barrier (grease injection head) to fill the gaps in the braid with grease and pressurized grease in the BOP.

In a basic wireline setup, using a braided cable, the wireline cable will be mounted on a winch. The winch is powered by an HPU. The winch will give the operator a feedback on depth and load in the cable. From the winch the wireline will go to the first sheaves and up in the wireline mast. From the top of the mast there will be a stuffing box and a line wiper (to remove grease) and some flow tubes connected with the grease injection head, which is the primary barrier. The next valve is a ball valve which will prevent flow from exiting the well if the wireline is pulled out.

The next valve in the setup is the tool catcher. The tool catchers purpose is to catch the tool if the wireline is pulled too far into the setup and the tool holder is broken. The lubricator is

installed after. This is the section which is used to change or insert tools into the wireline setup. And next, the BOP is installed. The BOP works as a redundant fail-safe valve which will cut the line if needed. After the BOP the risers are installed, the purpose of the risers is to get the BOP at a desired level on the platform. The BOP is operated and controlled by the grease/BOP-pressure control unit. The riser is connected to the well by the wellhead adapter (Paaske 2017).

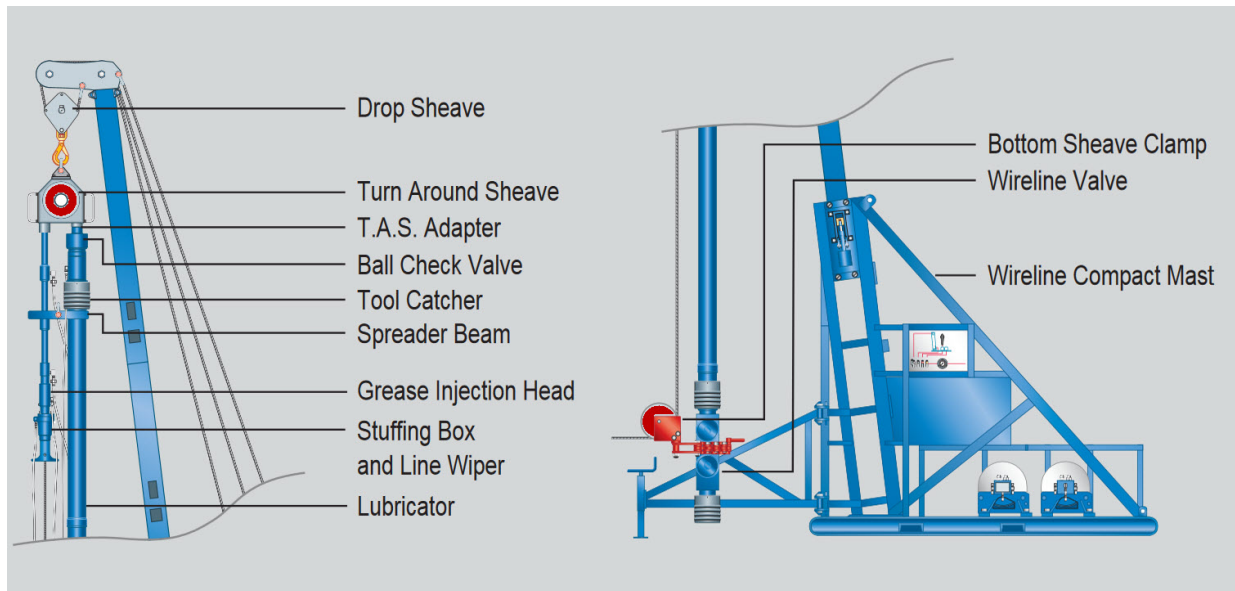

**Figure 2.4:** Wireline setup (Paaske 2017).

## 2.4 Overhead Cranes

The overhead crane was invented by a German company in the 1830's and entered mass production in 1840's as a part of the industrial revolutions. The first overhead cranes were steam powered. In 1876, in Liverpool. The EOT crane was designed and supplied by Sampson Moore. The crane was used to move guns at the Royal Arsenal in Woolwich, London.

Today the EOT crane is the most common type of overhead crane, it is found in many factories all over the world. The cranes are usually operated by control pendant, radio remote or operator cabin on the crane (Cassidy 2014).

There are various types of overhead cranes and many of which are highly specialized. In general, most of the overhead cranes will fall into one of the four categories: Single girder crane, double girder crane, gantry crane or monorail.

A single and double girder crane consist of one or two girders which are riding on top of a beam system. The difference of the single and double girder crane is as the name says, the single girder crane consists of one girder where the trolley is running bottom flange. The double girder crane consists of two girders where the trolley is running on the top flange. The single girder cranes in general holds smaller capacities and smaller bridge span.

The gantry cranes are a portal crane, where the crane itself have the columns installed and is running on ground level. The monorail is a simple crane where one movable direction is removed, as the crane girder, i. e. the monorail cannot be moved (Bhatia 2012).

The EOT crane is for analysis and investigation divided into a series of system and sub-systems. The main systems are:

- Bridge
- Hoist
- Instrument
- Other
- Runway
- Trolley

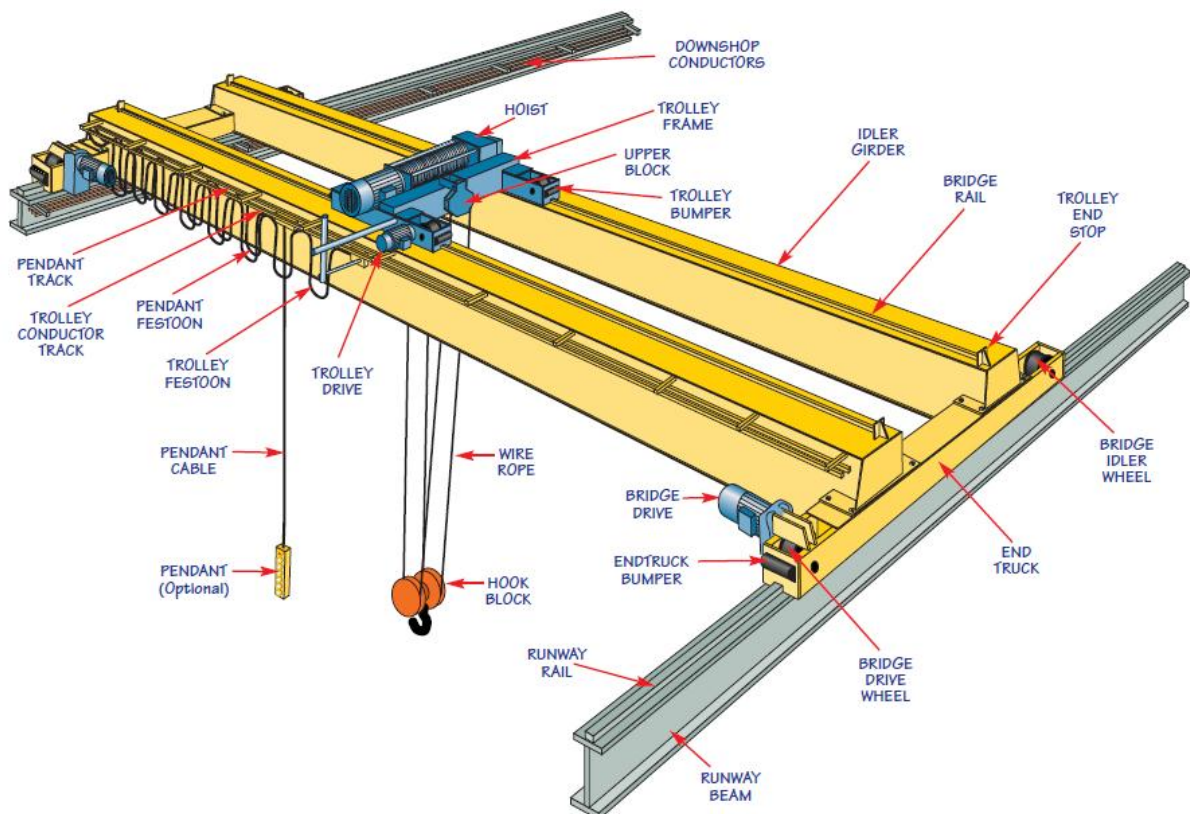

**Figure 2.5:** Electric Overhead Travelling crane (Bhatia 2012).

The bridge is the solid girder or girders, the drive mechanism, and the gear rack for the trolley. Included in the drive mechanism are the crane drive motor, brake, gear, and the pinion for gear rack.

The hoist is the part of the crane which is lifting the actual load. It is mounted into the trolley and consist of derailment protection, hoist drive, upper and lower blocks, wire rope and wire rope clamp. The hoist drive includes drum, gear, motor, and brake.

Instrument is a large system which includes all the sensors, controls, and electrical connections in the crane. Sensors such as: Anti-collision, limit switches for bridge, hoist and trolley, and overload switch for hoist. Controls such as pendant or radio remote. Other sub-systems such as: Electrical protection system, junction boxes, others, and relays.

The system of other is in place to facilitate anything which are not included in the other systems.

Runway is the girders where the crane bridge run, installed on the runway are the gear rack for the bridge.

The trolley is built up by the boogie, the drive unit, and the wheels. The drive unit consist of a motor with a brake, gear, and drive pinion.

A diagram of the subsystems and parts in the systems can be found in appendix A.

## 2.5 Dreggen Crane

Dreggen Crane was started as Dreggen Crane AS in 1987 by engineers from earlier Munch Offshore. Which later on bought the bankrupt estate of Munch Offshore. In the beginning Dreggen Crane delivered only engineering services towards the offshore industry.

In 1993 Dreggen Crane got a large order on EX-crane delivery to Statoil's Kollsnes facility. This order led to the start of their own production of cranes. In 1994 the first cranes were delivered to Korean, Chinese and Japanese ship yards. The growth in the 1990s was substantial.

In 1999 a licensed production of cranes in Korea was started and Dreggen got their own assembly facility in Lithuania (Skipsrevyen 2012).

From 2007 Bergen Group Dreggen was a wholly owned subsidiary of Bergen Group. Bergen group more than quadrupled the turnover in Bergen Group Dreggen. In 2012 Bergen Group Dreggen was acquired by Palfinger Group, changing the name to Palfinger Dreggen (Maritimt Magasin 2012).

### 3 Theory

This chapter has the purpose to give a review of maintenance, the development of maintenance, further on to maintenance today and RCM, continuing to applicable laws and regulations.

#### 3.1 Development of maintenance

Maintenance and maintenance management have during the 20th century had a significant development. This development can partly be credited the development of machinery during the same time. From the start of the 20th century with simple machines demanding relatively few maintenance actions, which was easy to repair to the modern more complex machines which we are dependant on to be available at any time.

Moubray (1997) has divided the development of the expectations to maintenance into three generations. Starting prior to the second world war and continuing today.

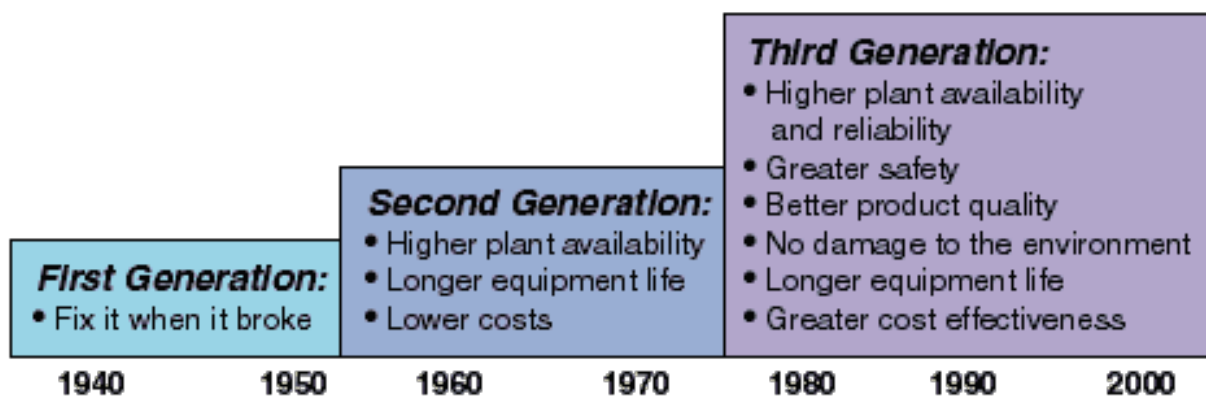

Figure 3.1: Growing expectations of maintenance (Moubray 1997).

##### First generation

The first-generation maintenance covers the period prior to the second world war and until late 1950s. At the time the machines were simple, easy to repair and downtime was not a big issue. This gave no motivation to set maintenance into a system and improve it. The maintenance tasks scheduled was in general washing and lubrication tasks. The machines were repaired when there was a need for repairs.

##### Second generation

The situation changed during the second world war. Time of war increased the demand of all types goods at the same time as the industrial working forces was decreasing. By the 1950s there had been a significant increase in the number of machines used in the industry. At the same time the complexity of the same machines had increased in a similar rate.

As the dependence of these machines increased, the focus shifted to availability. This led to the concept of preventive maintenance; maintenance was to be done after predetermined criteria's or at a planned time to sustain the components of a machine. During the 1960s this led to maintenance or overhaul being performed at fixed intervals.

When the focus on maintenance shifted and number of maintenance actions increased, the cost increased at a similar rate. This led to the development of planning and control systems for maintenance.

### Third generation

From the middle of the 1970s the development was over in the third generation. Changes was in general motivated by new expectations, new research and techniques and an increasing focus on cost.

Large competition in the marked together with an ever-increasing complexity of machinery had the need for more customized maintenance actions to keep the cost low, availability high and reliability high. Whole factories could suffer a complete stop due to downtime on a single machine (Moubray 1997).

## 3.2 Reliability Centred Maintenance

Today maintenance strategies are in general differentiated between planned and not planned maintenance. The latter more failure based. Under planned maintenance one will find corrective maintenance and preventive maintenance. Preventive maintenance could be both based on condition by condition monitoring data, or it could be based upon firm intervals such as calendar, or hours (Kumar & Kumar 2004).

A modern concept, and the basis for the thesis work is the RCM methodology. As for many maintenance techniques and methods, RCM has its roots in the aircraft industry, the background for the development of RCM was a large occurrence of failures and accidents regardless of having comprehensive PM programs. Giving incentives to develop a methodology which had a different focus of priority. Experiences from the industry shows significant cost reduction while maintaining or even improving the availability of system, using this method.

Today RCM analyses are used as a support tool for decision-making in all industries, both land based and offshore. RCM can be used both the construction and operations phase of the machinery.

RCM can be completely described by its four unique features (Smith & Hinchcliffe 2004):

- Preserve functions.
- Identify failure modes that can defeat functions.
- Prioritize functions needed.

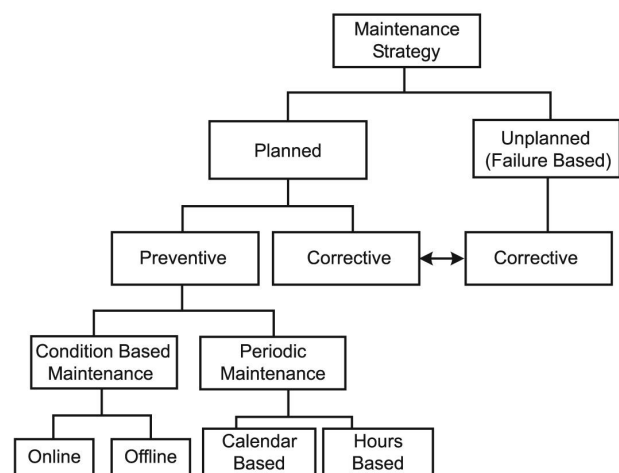

**Figure 3.2:** An illustration of different approaches to maintenance strategy (Kumar & Kumar 2004).



- Select applicable and effective PM tasks for the high priority failure modes.

The four features are implemented in a systematic and step-by-step manner in chapter 4.

### 3.3 Regulations

Maintenance, as every machine and activity in the industry is regulated by law. The laws applicable for EOT cranes offshore will be the Labour act and the Petroleum law.

These laws are further elaborated in several regulations, but the most important will be the regulation for working conditions and the regulation for activities in the petroleum sector.

The regulations often have a guidance note which is not mandatory to follow, though PSA (2018) writes that the guidance note must be looked at in the context of reading the regulations.

The guidance notes to the regulation for activities in the petroleum sector states a recommendation to use the design standard NORSOK R-002 for procurement of new equipment, the standard for using, controlling, and maintaining lifting equipment NORSOK R-003 and the NORSOK Z-008 on the area of Health, Safety and Environment (HSE) with respect of consequence classification (PSA 2018).

The NORSOK R-002 standard is a design standard for material handling equipment, which is valid on all fixed or floating installations, mobile offshore units, barges, and vessels, as well as land-based plants where petroleum activities are performed. NORSOK R-002 states that lifting equipment shall be designed and arranged with means for efficient maintenance which ensures safe conditions throughout the lifetime of the machine. The maintenance shall be planned in the following prioritized order: Safety, reliability, and availability (Standard Norge 2017a).

NORSOK R-003 is a standard for the use, inspection, and maintenance of lifting equipment installed in the same areas as for the R-002 standard. The NORSOK R-003 standard states that maintenance of lifting equipment and machinery shall be administrated, performed and reviewed according to the requirements stated in the regulations for activities in the petroleum sector. Further on the maintenance shall be performed according to the manufactures instructions, and the PM program for complex lifting machines shall focus on preventing failures on components which in terms will give a high risk for dangerous situations.

Prioritized PM tasks for critical components will normally be one of the following: maintenance to sustain the components function, inspection to reveal the components state or replacement of component in a given interval recommended by the manufacturer, or according to experience.

In addition, the lifting equipment are subject to a control by an enterprise of competence. This control shall verify the lifting equipment's technical state and serve as an additional barrier. It is differentiated between the following types of controls:

- Initial control.
- Periodic control.
- Extraordinary control.

Initial control is performed before first time use of the lifting equipment. The purpose is to verify conformity with the regulations, safe installation and function, and necessary documentation is available.

Periodic control is performed on a periodic basis by enterprise of competence. Every lifting equipment shall be subject for a periodic control at least every 12 months. This periodic control is done according to the user manual and shall at least include:

- Control of documentation.
- Control of earlier reports from enterprise of competence, maintenance, and equipment history for the last period.
- Use of the machine according to design life and assessment of the need for lifetime analysis.
- State control including marking.
- Functional testing.
- Writing a report of performed control.

Extraordinary control is performed by enterprise of competence if the lifting equipment has a given requirement of extraordinary control, has been the subject of overloading, after larger modifications, after change of ownership or when it is requirement because of the environment the lifting equipment is installed in. An extraordinary control will be more thorough compared to a periodic control (Standard Norge 2017*b*).

NORSOK Z-008 is a standard for risk-based maintenance and consequence classification. In the operational phase of equipment, it can be used for updating and optimisation of existing maintenance programs Giving guidance to prioritising work orders and performing life extension. The standard is applicable for preparation and optimisation of maintenance activities for plant systems (Standard Norge 2017*c*).



## 4 Methodology

The methodology chapter will give a review of the methods and techniques used to answer the research question.

Yin (2014) writes that case study strategy should be used when the three following conditions apply: the research question is formulated with a how or why question, the investigator has little or no control over the actual behavioural elements, and the degree of focus on contemporary as opposed to historical events. Summarized: “A “how” or “why” question is being asked about a contemporary set of events over which the investigator has little or no control”.

Gupta & Mishra (2016) analysed 19 different RCM frameworks in a several Strength Weaknesses Opportunities Threats (SWOT) analysis grouping the different frameworks into three groups:

- Group A are semi-quantitative and qualitative frameworks used to plan preventive maintenance based upon continuous improvement.
- Group B are quantitative frameworks based on logical and structures reliability analysis, which demands a large amount of data.
- Group C are practical qualitative frameworks.

Smith & Hinchcliffe (2004) has a group A framework according to Gupta & Mishra (2016). The RCM framework by Smith & Hinchcliffe (2004) are used, and it is run like a case study as applicable by Yin (2014). The main steps of the RCM analysis are defined as:

- Step 1: System selection and information collection.
- Step 2: System boundary definition.
- Step 3: System description and functional block diagram.
- Step 4: System functions and functional failures – Preserve functions.
- Step 5: Failure mode and effects analysis (FMEA) - Identify failure modes that can defeat the functions.
- Step 6: Logic (decision) Tree Analysis (LTA) - Prioritize function need via the failure modes.
- Step 7: Task selection – Select only applicable and effective PM tasks.

Completion of these seven steps will provide a well-documented, solid base line for definition of PM tasks. To complete a successful RCM analysis and implementation two additional steps will need to be carried out:

- Step 8: Task packaging – Carrying recommended RCM task to the floor.
- Step 9: Living the RCM program – Compromising the actions necessary to sustain over time.

Step 1 to 7 are the focus of this thesis' theoretical approach.

## 4.1 System selection and information collection

The first step of the RCM analysis will be the system selection and information collection. The system selection or at which level in the assembly to do the analysis can be divided into four levels:

- Part, which will be the lowest level any equipment can be disassembled without destroying any item. Parts could be gaskets, gears, wire rope, etc.
- Component, a grouping, or selection of parts assembled into an identifiable package which will hold at least one significant function as a stand-alone item. Components could be valves, pumps, motors, circuits boards, etc.
- System is a logical grouping of components for any key functions. Plant or facilities are composed of several systems: fire protection, cranes, process, drilling, etc.
- Plant or facility is the largest level, which included several systems to function together.

After choosing at which level of assembly to do RCM analysis, one would need to use a tool determine which systems, components or part would have the largest benefit of the analysis. This tool is called the 80/20-rule. This rule states that 80% of observed trends tends to reside in 20% of the available source. Basically, one will take the historic data available, group into systems, components or parts and look for trends in the data with simple graphs, where occurrence of failures in given systems are grouped in descending order. This is called Pareto diagram (Smith & Hinchcliffe 2004). To do this there would initially have to be developed some form of grouping system first. For this thesis the grouping system are explained in section 2.4 and could be found in full in appendix A.

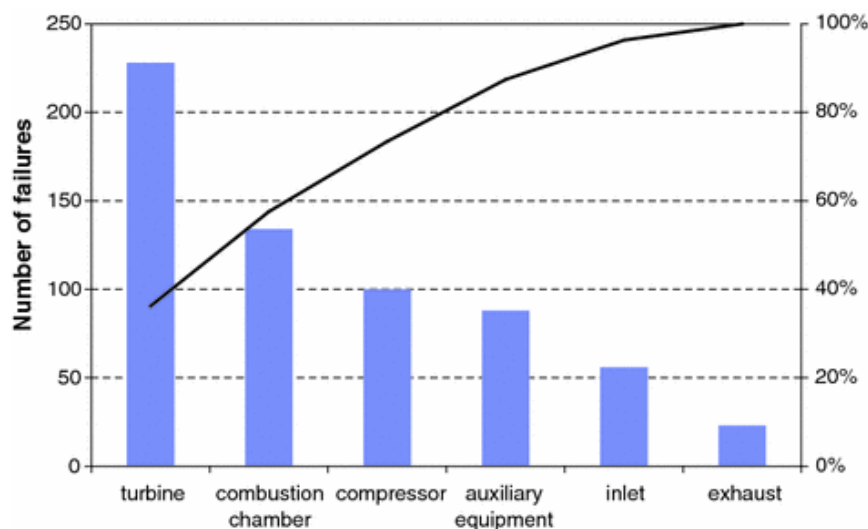

**Figure 4.1:** Pareto diagram example (Tinga 2013).

The last part of this step is about information collection. Information needed for analysis could be, and not limited to, manufacturing record book (MRB). MRB are including Piping & Instrument Diagram (P&ID), General Arrangement (GA) and part drawings, data sheets and Installation, Operation, and Maintenance (IOM) manual (Smith & Hinchcliffe 2004).

## 4.2 System boundary definition

Next step, step 2 is for identifying the system boundaries as well as major components in the system. This specification is important; a component in another system could be given the analysed system information, thus this needs to be identified, as well as the major boundaries needs to be defined in terms of locking the scope of analysis (Smith & Hinchcliffe 2004).

## 4.3 System description and functional block diagram

On step 3 one is looking to describe the system within the boundaries initially set in step 2. Going through this step the following information will be assembled or produced:

- System description.
- Functional block diagram.
- IN/OUT interfaces.
- System Work Breakdown Structure (SWBS).
- Equipment history.

System description is a vital part of this step. The system description is done to give the analyst and the reader of the analysis a thorough understanding of the system which are analysed, as well as a base line for the system; the analysis could change the functional description, or over time the functional description could be changed. The system description header contains specific information about the plant, system, sub-system, analysts, tags, revision codes and date. The main part of the system description contains functional information about the system or key parameters, redundancy features, protection features and key control features.

Functional block diagram is made to give the analyst and the reader a better understanding about how the machines systems are connected to each other and how the boundaries are connected to the system. It will give an overview about the in and outs of the system as well as the internal signals and energy transferred between systems.

IN/OUT Interfaces is a document building on the boundary description from step 2, where one will give more detailed information about the media which are the boundary and the interface location.

System Work Breakdown Structure or SWBS is old terminology used in the Department of Defence applications of RCM, it is used to describe a list of equipment or components in functional subsystems or systems. This component list contains information about the components in the machine, TAG number for component ID; for those who have a TAG number, a description of the component, the main system this component belongs to, the sub-system, a type indication, quantity and a drawing reference. The type indication is for instruments only and the instruments are given a distinction of control, protection, or status information only. Any instrument given a status for information only will automatically go to the run-to-failure (RTF) list.

The equipment history file is compiled with historic information from the given machine. This list will contain a minimum of component description, failure mode and failure cause. For connection to the other documents the list get date, tag number, system, and sub-system as additional

information. The equipment history is valuable information in completing step 5, FMEA (Smith & Hinchcliffe 2004).

#### 4.4 System functions and functional failures

The previous steps have all been to provide a solid baseline for the analysis. This step will be done in order to satisfy the first principle of RCM: To preserve system functions. Therefore, it is important that this step catches every component with given functional failures.

In the last step the OUT interfaces were identified, the OUT interfaces will be the primary source for identifying system functions. OUT interfaces define the products of the system.

When formulating the function statements, one should bear in mind that this is not component statements. Avoid using a reference to the name of the component in the functional statement. See table 4.1 for an illustration.

**Table 4.1:** Illustration of correct functional statement (Smith & Hinchcliffe 2004).

Incorrect	Correct
Provide 1500 psi safety relief valves.	Provide for pressure relief above 1500 psi.
Provide a 1500 GPM centrifugal pump on the discharge side of header 26.	Maintain a flow of 1500 GPM at the outlet of header 26.

When the function statements are set, one will provide a set of functional failures where the intended component do fail to deliver its complete function. Table 4.2 provides an example.

**Table 4.2:** Example of functional failures (Smith & Hinchcliffe 2004).

Function	Functional failure
Provide for pressure relief above 1500 psi.	a. Pressure relief occurs above 1650 psi. b. Pressure relief occurs prematurely (below 1500 psi).
Maintain a flow of 1500 GPM at the outlet of header 26.	a. Flow exceeds 1500 GPM. b. Flow is less than 1500 but greater than 1000 GPM. c. Flow is less than 1000 GPM.

In the functions it is observed that the function will not fail before a certain threshold is exceeded. This margin comes from the functional description and a thorough understanding of the system (Smith & Hinchcliffe 2004).

#### 4.5 Failure mode and effects analysis

Step 5 in the RCM analysis process will be the first time a component is directly connected to a functional failure by identifying specific hardware failure modes that could produce functional failures. This will satisfy the second feature of the RCM process.

Smith & Hinchcliffe (2004) writes about a tool called equipment-functional failure matrix, this matrix is made to connect the different components to functional failures. It starts with listing the different components from the SWBS and combine this with the functional failures identified in step 4. At each intersection given by a component which can suffer from the given functional

failure it is indicated by placing the letter ”X”. The easiest way to do this is to work down the list component for component.

**RCM—Systems Analysis Process**

Step 4: Functions/functional failures

Information: Equipment—functional failure matrix      Rev no.:      Date:

Plant:      Plant ID:

System name:      System ID:

Analysts:

No.	Equipment (or component) name	Functional failures				

**Figure 4.2:** Equipment-Functional failure matrix example (Smith & Hinchcliffe 2004).

By doing the equipment-functional failure matrix one will identify the different components which will have similar or the same functional failure.

**RCM - Systems Analysis**

Step 5-2    **Failure Mode and Effects Analysis**      Plant ID:

Information:    Functional Failure #      System ID:

Plant:      Rev No:

System:      Date:

Subsystem:

Analysts:

FF#	Comp	Component Description	FM #	Failure Mode	FC #	Failure Cause	Failure Effect			LTA
							Local	System	Plant	
<div style="border: 1px solid black; padding: 5px; display: flex; justify-content: space-between;"> <span>System:      Tuesday, April 22, 2003</span> </div> <div style="border: 1px solid black; padding: 5px; display: flex; justify-content: space-between;"> <span>Subsystem:      Page 1 of 1</span> </div> <div style="border: 1px solid black; padding: 5px; text-align: center; margin-top: 5px;">             Step 5-2 Failure Mode and Effects Analysis JMS Software           </div>										

**Figure 4.3:** Failure Mode and Effect Analysis example (Smith & Hinchcliffe 2004).

After completing the equipment-functional failure matrix the FMEA are to be performed at every intersection indicated with a X. Smith & Hinchcliffe (2004) writes that the best way to approach this task, in their experience, is to select on or two functional failures with the most X in their column and initially complete the FMEA at each X. As each component in the column is completed, its failure modes should be reviewed against the other functional failures with a X to see if they may equally apply. The chances are that the failure modes identified will satisfy at least

some other functional failures. Thus, eliminating the need to perform FMEA at several locations.

With reference in figure 4.3. The first column in the FMEA is the identifier for the functional failure analysed on the given line. The specific component can be identified in the second column. The same identifier can be found in the SWBS and equipment-functional failure matrix. Column 3 are similar, only here a component description is found.

The fourth column is the identifier for the failure mode, and column 5 is giving a description of that failure mode. This is where the analyst needs to establish the given failure mode of the given component which in terms can lead to the given functional failure. Typical descriptors for failure modes are given in table 4.3. The analysis is limited to dominant failure modes; the failure mode must depict a problem that can be realistically address by a PM task, e.g. maintenance is not done on a microchip, and the failure mode must be a plausible situation.

**Table 4.3:** Typical descriptors for failure modes (Smith & Hinchcliffe 2004).

Abrasion	Damaged	Jammed	
Arcing	Damp	Lack of -	Punctured
Backward	Defective	Leak	Ruptured
Out of balance	Delaminated	Loose	Scored
Bent	Deteriorated	Lost	Scratched
Binding	Disconnected	Melted	Separated
Blown	Dirty	Missing	Shattered
Broken	Disintegrated	Nicked	Sheared
Buckled	Ductile	Notched	Shorted
Burned	Embrittlement	Open	Split
Chafed	Eroded	Overheat	Sticking
Chipped	Exploded	Overtemp	Torn
Clogged	False indication	Overload	Twisted
Collapsed	Fatigue	Overstress	Unbonded
Cut	Fluctuates	Overpressure	Unstable
Contaminated	Frayed	Overspeed	Warped
Corroded	Intermittent	Pitted	Worn
Cracked	Incorrect	Plugged	

Should the sole cause of a hypothesized failure mode be a human error, this is dropped form the analysis. It is not possible to create a PM task which can address human error. Although an Item of interest (IOI) may be applicable.

The next columns are dedicated to an attempt to identify the root cause of each failure mode. First and identifier, latter the failure cause is written in text. It is only the direct failure root cause which are interesting in the maintenance analysis. No matter how much maintenance are done on component B will ever help avoid failure in component A. Looking through the historic data Smith & Hinchcliffe (2004) writes that the analyst will undoubtedly find that equipment history files are quite sparse when it comes to root cause information.

The final step of the FMEA is to analyse which effect a failure will have upon the given system. This is done on three levels. Local, which will be the same as sub-system, System level, corresponding to a system, and plant level. The effect analysis has two main purposes: First to identify that the actual failure mode in question has a relationship to de given functional failure,

and second to identify that the given failure mode will give a system or machine consequence. The last column in the FMEA is labelled LTA. Here a yes or no will indicate whether the failure mode is carried forth to step 6 or left untreated until step 7 and the sanity check (Smith & Hinchcliffe 2004).

### 4.6 Logic (decision) Tree Analysis

Smith & Hinchcliffe (2004) use the LTA as a simplified criticality classification in the RCM method. The LTA is used in a qualitative process where one will process the failure modes from the FMEA. The purpose is to prioritize the resources that should be devoted to each failure mode based on need. Thus, satisfying the third feature of the RCM method.

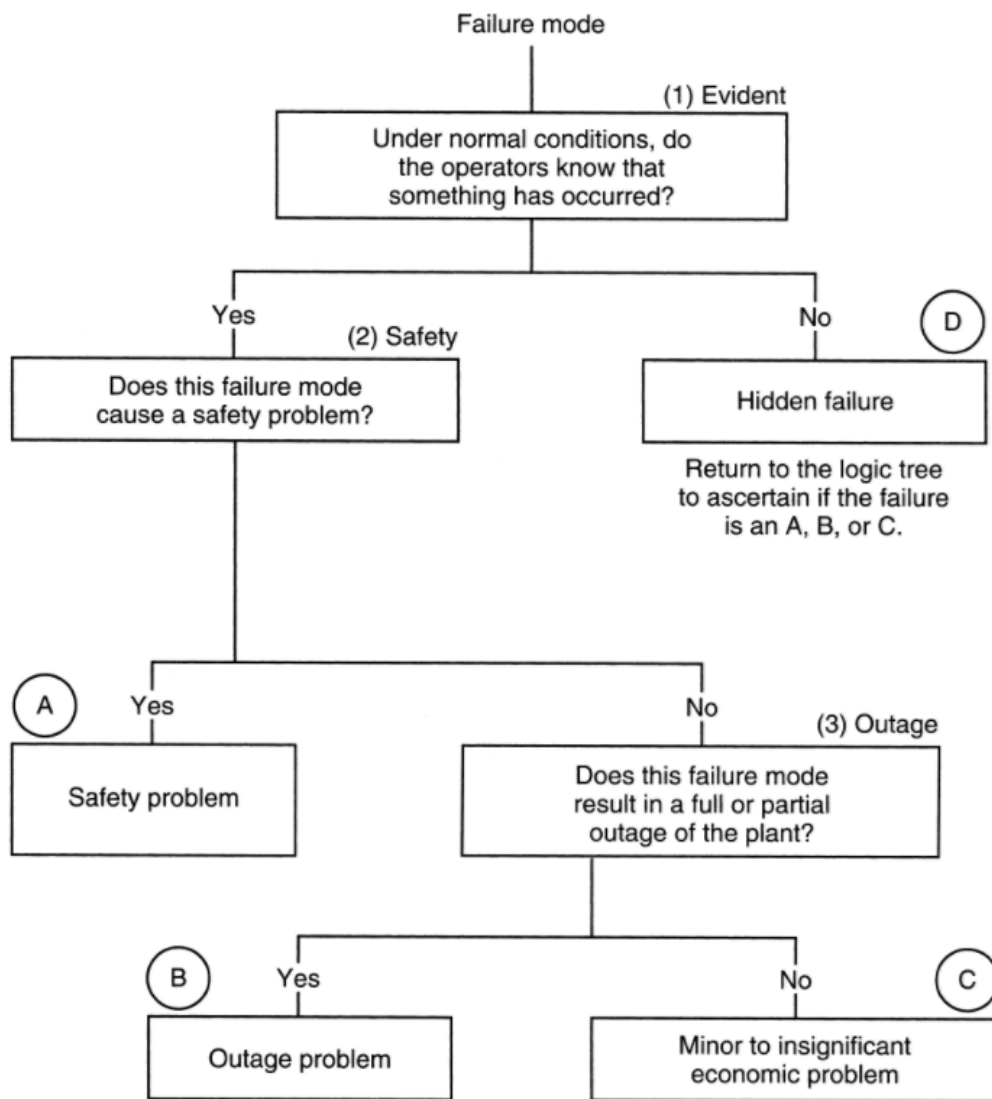

**Figure 4.4:** Logic Tree Analysis structure (Smith & Hinchcliffe 2004).

The LTA process is done as shown in figure 4.4 and put in to system as shown on figure 4.5. Each failure mode is put through the tree, starting with a question to determine if it is a hidden failure or not, the question is called "Evident". Giving the failure mode the letter (D) if it is a hidden failure. Either way the next question will be if this failure mode causes a safety problem.



Smith & Hinchcliffe (2004) writes that safety problem is defined as personnel injury and death, though the user is free to define the what a safety problem will be. In this analysis damage to structure and injury to personnel are both defined as safety problems. A safety problem will give the failure mode the letter (A).

If the failure mode does not pose a safety problem, the remaining consequence deals strictly in facility economics: Will the failure mode cause a full or partial outage of the plant. This question is formulated to split large and small economic penalties. Smith & Hinchcliffe (2004) defines the border between small and large economic penalties as loss of input less, equal or larger than 5%. Large outage classifies as a (B) and small outages classifies as (C).

In sum this will give the analyst a measurement for prioritizing the following PM tasks to the given failure modes, in the following order:

1. A or D/A.
2. B or D/B.
3. C or D/C.

The classification C tends to be to raise a dilemma in the sense that the consequence is small. Usually this letter will go to the RTF list. Smith & Hinchcliffe (2004) recommend that only failure modes given a classification A or B would be passed on to step 7.

RCM - Systems Analysis			
<b>Step 6</b>	<b>Logic Tree Analysis</b>	<b>Plant ID:</b>	
<b>Information:</b>	<b>Failure Mode Criticality</b>	<b>System ID</b>	00651-020304
<b>Plant:</b>	VKF HPA Auxiliary Plant	<b>Rev No:</b>	
<b>System:</b>	JM3 Pumping System	<b>Date:</b>	
<b>Subsystem:</b>	C92 Compressor System		
<b>Analysts:</b>	Ed Ivey, Brian Shields, Brown Limbaugh, Ronnie Skipworth, Glenn Hinchcliffe (facilitator)		

FF #	Comp #	Component Description	FM #	Failure Mode	Evident?	Safety	Outage	Cat	Comments
1.1	03	Compressor	3.29	Inlet/outlet piping gasket	YES	NO	YES	B	
1.1	03	Compressor	3.30	Cooler waffle gasket deterioration or debonds	NO	NO	YES	D/B	
1.1	04	Wiring and Connections	4.01	Insulation failure leading to a short	NO	YES	YES	D/A	
1.1	04	Wiring and Connections	4.02	Connections become loose, broken, or corroded	NO	NO	YES	D/B	
1.1	05	Process Air Relief Valve LPA-RV-921-U	5.01	Loss of spring tension	NO	YES	YES	D/A	
1.1	05	Process Air Relief Valve LPA-RV-921-U	5.02	Valve sticks closed	NO	YES	YES	D/A	Valve has never been bench tested
1.1	06	V925A Check Valve	6.01	Fails to reseal	NO	NO	YES	D/B	
1.1	06	V925A Check Valve	6.02	Fails to open	YES	NO	YES	B	
1.1	07	V921 Air Operated Control Valve	7.01	Packing leak	NO	NO	NO	D/C	
1.1	07	V921 Air Operated Control Valve	7.02	Bound stem	YES	NO	YES	B	

<b>System:</b>	JM3 Pumping System	Saturday, May 24, 2003
<b>Subsystem:</b>	C92 Compressor System	Page 1 of 1
<b>Step 6 Logic Tree Analysis</b> <b>JMS Software</b>		

Figure 4.5: Typical Logic Tree Analysis on form for Step 6 (Smith & Hinchcliffe 2004).



## 4.7 Task selection

The final step, step 7, contains 3 sub-steps which are to be done in the following order: First the task selection process, further on the sanity check and at last the task comparison step.

### 4.7.1 Task selection process

The analysis efforts have to this point been directed to prevent the failure modes which causes the highest consequence. As the designation done in step 6.

For each failure mode, the analysts task is now to determine a list of applicable candidates of PM tasks. In order to satisfy the fourth feature of the RCM the task is required to meet the applicable and effective test, defined as:

- Applicable. The task will prevent or mitigate failure, detect onset of failure, or discover a hidden failure.
- Effective. The task is the most cost-effective option among the competing candidates.

If no applicable task exists, the only option is RTF. Likewise, if the cost of a PM task exceeds the cumulative cost of failure.

Developing the PM task list is a crucial step and require information from several sources. These sources of input are defined as, but no limited to: technical data, vendor expert advice and historic data.

The road map given in figure 4.6 is used to define the task selection process. This figure is a useful tool in helping the analyst to develop the PM task for each failure mode.

1. Following the road map, the first question is *"Is the age reliability relationship of this failure known"*? Going from this question one will have three options: Yes, Partial and No. Usually the equipment history will not be enough to identify a clear age reliability relationship, though the partial answer could be used if there is information or data about failure modes which can indicate ageing wear out. The equipment failure density function can be calculated using Weibull analysis. Weibull analysis is used when the failure density will increase or decrease with increasing age of the component. Weibull distribution is described mathematically:

Probability of function:

$$R(t) = e^{-\left(\frac{t-t_0}{\eta}\right)^\beta} \quad (4.1)$$

Failure rate:

$$Z(t) = \frac{\beta}{\eta^\beta} (t - t_0)^{\beta-1} \quad (4.2)$$

Where:

$t_0$  - Minimum time to failure.

$\eta$  - When  $t - t_0 = \eta$   $R(t)$  is equal to  $e^{-1} = 0,368$ . I.e.  $\eta$  is the time interval from the time  $t_0$  to the time which probability gives 63,2% of the components has failed and 36,8% of the components has survived.

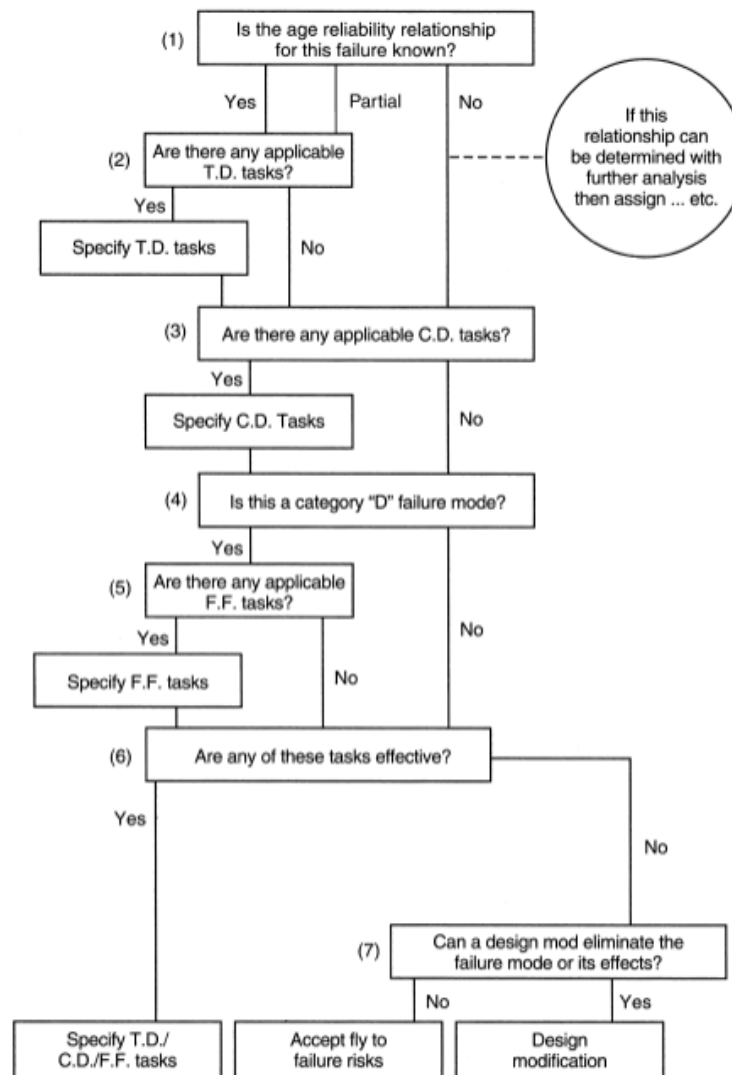

**Figure 4.6:** Task selection road map (Smith & Hinchcliffe 2004).

$\beta$  - Shape factor. The shape factor is defined as infant life failures if  $\beta < 1$ , wearing out if  $\beta > 1$  or constant failure rate if  $\beta = 1$  (Bye 2009).

Using the Mean Time Between Failure (MTBF) is an alternative and sounds easy enough. One should note that using MTBF as a measurement for failure frequency will allow the component to fail 50% of the time before PM is performed (Smith & Hinchcliffe 2004).

$$MTBF = \frac{1}{n} \sum_{i=1}^n t_i \tag{4.3}$$

Where:

$t_i$  - A given time between failure.

- If the answer is yes or partial the analyst will proceed to the second question which is if there are any applicable Time-Directed (TD) tasks. If the analyst can use the Weibull analysis to determine the reliability rate or there are some other quantitative or qualitative method to determine a time interval for a TD task, this is where the TD task is specified. The TD task can then be specified at the desired probability of function.

3. Even if a TD PM task is specified, if the analyst has found no applicable TD tasks or if the analyst has no data giving indication of age reliability relationship, the next section in the road map is if there are any applicable Condition-Directed (CD) tasks. This is the time to pursue the path if TD tasks are somewhat on a shaky ground, if there is a lack of good data. The CD tasks rely upon some form of condition monitoring in order to keep track of the condition.
4. Either from specifying CD tasks or if there are no specification of CD tasks the next step is to go back in the LTA to check if this is a hidden failure mode.
5. If yes to question (4) the analyst should check if it is possible to specific a non-intrusive failure finding (FF) or inspection task. If yes, specify the failure task, and go to check if the tasks can be effective, or go straight to check if the tasks are effective.
6. Now the analyst is ready to examine the relative costs for the specified tasks in (2), (3) and (5), and even the RTF cost. The goal is to select the lowest cost option.
7. The last question is aimed in checking if the analyst would consider a design modification if none of the specified tasks are applicable or effective tasks. If the given task is a designated A-task, the automatic option is a design modification, if not, the task should be RTF.

The form in figure 4.7 is used to record the decisions made from the road map. There are additional columns for candidate task, effective info, selective decision and estimate frequency. The candidate task column contains all the suggested tasks. Effective info. column is where the analyst will register additional information about this failure mode. The selective decision is the task selected and the Est. frequency column is to give the task an estimated frequency or periodicity (interval).

**RCM - Systems Analysis**

<b>Step 7-1</b>	<b>Task Selection</b>	<b>Plant ID:</b>
<b>Information:</b>	<b>Selection Process and Decision</b>	<b>System ID:</b>
<b>Plant:</b>		<b>Rev No:</b>
<b>System:</b>		<b>Date:</b>
<b>Subsystem:</b>		
<b>Analysts:</b>		

FF #	Comp	Comp Desc	FM #	Failure Mode	FC #	Failure Cause	1	2	3	4	5	6	7	Candidate Task	Effective Info	Selective Dec.	Est Freq

**System:**

**Subsystem:**

Step 7-1 Task Selection

JMS Software

Tuesday, April 22, 2003

Page 1 of 1

**Figure 4.7:** Task selection form (Smith & Hinchcliffe 2004).

Selection of the interval which a PM task should be performed is by far the most difficult tasks an analyst could be confronted with. From a TD task the analyst will have some kind of information about the equipment failure rate, either it is from the manufacturers recommendations or it is the calculated failure rate based on historic data. This is the point where the analyst picks or defines the level of risk by selecting a percentage number for the failure rate, giving the estimated interval to when the TD PM task should be performed (Smith & Hinchcliffe 2004).

The next CD task and FF task are based on the idea which the analyst has no data over the age-reliability relationship. Thus, the tasks interval has to be specified more or less with guessing, trial and error. Usually this is done with great conservatism. Smith & Hinchcliffe (2004) offer a cautionary warning note about CD task. Smith & Hinchcliffe (2004) writes upon selection of CD

task one will have to specify not only the task interval but also the parameter value that must be used to alert the plant personnel if the failure process has started. Selecting the correct value may also be an initially guessing process and additional experience has to be systematically collected to adjust this value over time.

#### 4.7.2 Sanity check

Through several steps in the RCM process the analyst has been collecting components and failure modes on to an RTF list:

- SWBS – Information only instruments.
- FMEA – Only local effects.
- LTA – Priority C or D/C.

The form which are to be used is found in figure 4.8. This is the checklist for the sanity process. This checklist contains 8 reasons for considering performing a PM task on a failure mode which initially is set to RTF.

1. Marginal effectiveness. It is not known or clear if the RTF cost are significantly less than PM costs.
2. High-cost failure. No loss in critical functions but the failure mode will cause extensive and costly damage, it should be avoided.
3. Secondary damage. Failure mode could lead to extensive damage to other equipment.
4. Original Equipment Manufacturer (OEM) Conflict. The recommendation from the OEM conflicts with the RTF decision.
5. Internal conflict. Personnel feels strongly about a PM task that is not supported by the process.
6. Regulatory conflict. Regulations prevent from choosing RTF on a given component.
7. Insurance conflict. Like items 4 and 6.
8. Hidden. Re-evaluations of a failure mode. It may not be permitted to reach a full failure state.

If question 1 – 8 is answered with a No, the decision is to keep this component on the RTF list. If for some reason one or more of the questions are answered with yes, it will not automatically change the RTF to a PM task, but usually the analyst will favour a PM task (Smith & Hinchcliffe 2004).

#### 4.7.3 Task comparison

Even if the RCM analysis is done on an existing or new facility there should be some PM program or maintenance instructions to compare to. This step will be to match the failure modes and RCM suggestion to the OEM PM program or existing PM program. Information from the step 7-1 and 7-2 is included into the form shown in figure 4.9. The RCM-based PM tasks are then compared to the current tasks with the current frequency. This should give the recipient of the analysis a good overview over the new and old PM tasks either:

FF #	Comp #	Comp Desc	FM #	Failure Mode	Marg Eff	High Cost	Sec Dmg	OEM Conf	Int Conf	Reg Conf	Insur Conf	Hidden	RTF	Selection Dec	Est Freq	Comments
<div style="border: 1px solid black; padding: 10px; margin-bottom: 10px;"> <p style="text-align: center;"><b>RCM - Systems Analysis</b></p> <p> <b>Step 7-2: Task Selection</b> <span style="float: right;"><b>Plant ID:</b></span>  <b>Information: Sanity Checklist</b> <span style="float: right;"><b>System ID:</b></span>  <b>Plant:</b> <span style="float: right;"><b>Rev No:</b></span>  <b>System:</b> <span style="float: right;"><b>Date:</b></span>  <b>Subsystem:</b>  <b>Analysts:</b> </p> </div>																
<div style="border: 1px solid black; padding: 5px;"> <p> <b>System:</b> <span style="float: right;">Tuesday, April 22, 2003</span>  <b>Subsystem:</b> <span style="float: right;">Page 1 of 1</span>              Step 7-2 Sanity Checklist            JMS Software         </p> </div>																

**Figure 4.8:** Sanity checklist (Smith & Hinchcliffe 2004).

FF#	Comp #	Comp Description	FM #	Fail Mode/Where From	RCM Selection Dec/Cat	Est Freq	Current Task Description	Freq
<div style="border: 1px solid black; padding: 10px; margin-bottom: 10px;"> <p style="text-align: center;"><b>RCM - Systems Analysis</b></p> <p> <b>Step 7-3: Task Selection</b> <span style="float: right;"><b>Plant ID:</b></span>  <b>Information: Comparison RCM vs Current PM Task</b> <span style="float: right;"><b>System ID:</b></span>  <b>Plant:</b> <span style="float: right;"><b>Rev No:</b></span>  <b>System:</b> <span style="float: right;"><b>Date:</b></span>  <b>Subsystem:</b>  <b>Analysts:</b> </p> </div>								
<div style="border: 1px solid black; padding: 5px;"> <p> <b>System:</b> <span style="float: right;">Tuesday, April 22, 2003</span>  <b>Subsystem:</b> <span style="float: right;">Page 1 of 1</span>              Step 7-3 Comparison RCM vs Current PM Task            JMS Software         </p> </div>								

**Figure 4.9:** Task comparison (Smith & Hinchcliffe 2004).

1. RCM and initial PM task are identical.
2. Current PM task exists and should be modified to meet RCM-based task.
3. RCM-based PM task are recommended and no current task exists.
4. Current task exists, and no RCM-based task are recommended and are therefore candidate for deletion.

This step will finalize the analytical part of the RCM process (Smith & Hinchcliffe 2004).

## 5 Data collection

The first step in an RCM analysis is the system selection and information collection step, the purpose of this chapter is to supply information used in the first step in the order of use as far as possible.

First this chapter starts with system information: information about the cranes, component information and hierarchy, equipment history and the Corrective Maintenance (CM) performed and at last the PM program.

### 5.1 Cranes

The Ekofisk M-cranes are ATEX-certified; certified equipment intended for use in potentially explosive atmospheres, EOT Cranes custom built for ConocoPhillips on Ekofisk M. There are four cranes, two of Safe Working Load (SWL) 25 T and two of SWL 15 T. The cranes are mounted in the well intervention area. The cranes are designed and manufactured according to Machinery Directive 89/392/EEC and Norwegian standards NS 5514, NS 5515 and NS 5513 among some. ConocoPhillips (2018*d*) explains that the cranes, which were installed in 2004 have a very special use-case. The cranes are almost exclusively used under well interventions campaign. The campaign requires extensive usage of the cranes for 10-15 days every third month.

The cranes are inspected and maintained with a calendar-based frequency of one month, three months, six months, and 12 months. The maintenance instructions for maintenance exceeding these intervals are ambiguous and are more or less covered by the cryptic text: *“Every fourth year the crane should be subject of a more thorough control of steel structure and components”* (Dreggen Crane AS 2004*a*).

#### 5.1.1 25 T Cranes

The SWL 25 T Cranes (TAG: 07010 and 07015) are EOT Cranes with a capacity of 25 tonnes, the cranes are of double girder type with the trolley running on top. The running directions of the crane bridge is north and south, and the trolley move east and west (ConocoPhillips 2018*b*). The cranes were installed in 2004, the notification history and feedback for operators shows the cranes had a lot of childhood illnesses (ConocoPhillips 2018*e*).

In 2009 the cranes were modified by Aibel and Munck. This modification involved new bridge drive, new anti-collision system and rebuild for radio remote controls.

The new bridge drive was two new motors, gearboxes, and chains. Removing the old drive machinery which had one motor in one end and long axles spanning across the bridge for drive movement on the opposite side (Aibel AS 2010*b*).

The cranes are modified to facilitate the use of radio remote, and pendant control is classified as emergency control system. All movement is controlled by the new radio remote. Included with the installation of the radio remotes were installation of the anti-collision system. The anti-collision system consists of optical electronic systems mounted on the cranes to detect objects before they will obstruct the crane movement psychically (Aibel AS 2010*a*).



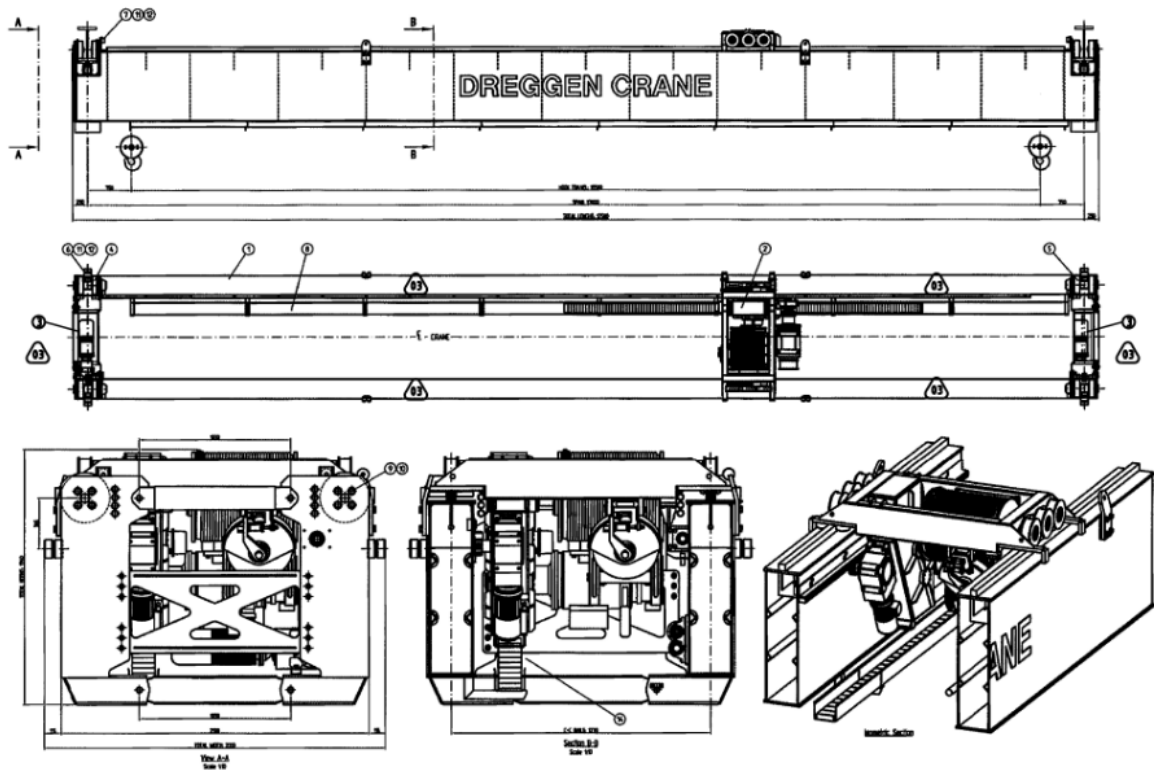

**Figure 5.1:** 25 T EOT Cranes, TAG: 07010 and 07015 (Aibel AS 2011).

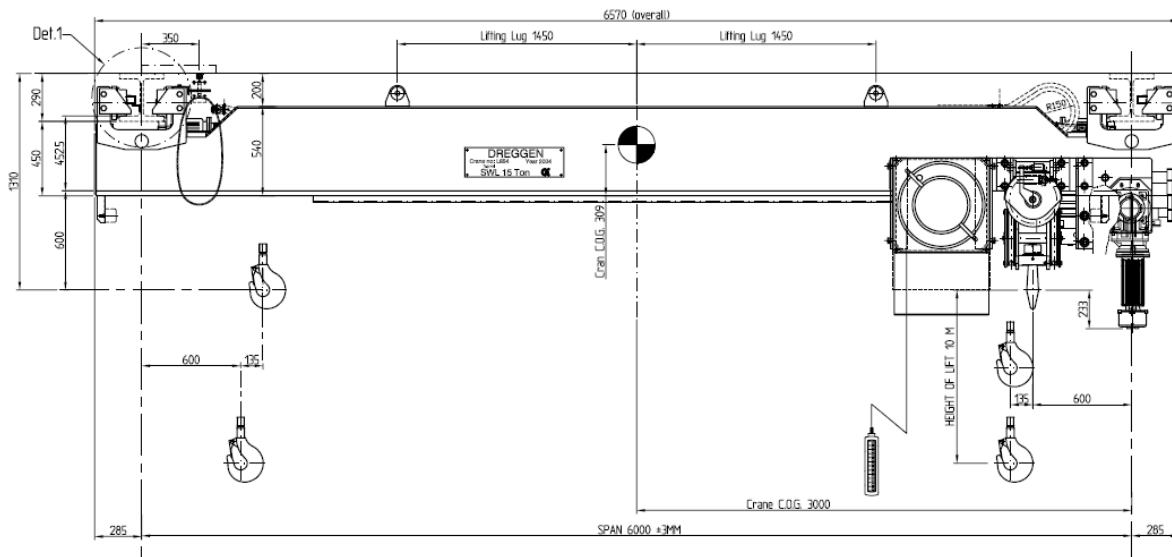

**Figure 5.2:** 15 T EOT Cranes, TAG: 07020 and 07025 (Dreggen Crane AS 2004b).

### 5.1.2 15 T Cranes

The SWL 15 T Cranes (TAG: 07020 and 07025) are EOT Cranes with a capacity of 15 tonnes, the cranes are built single girder type with the trolley running on the bottom flange. The running directions of the crane bridge is east and west, and the trolley move north and south (ConocoPhillips 2018b). The cranes were installed in 2004, and the notification history shows less problems with these cranes.



In 2009 the cranes were modified by Aibel and Munck. For these smaller cranes the modification was installation of radio remote, the pendant was classified as emergency control system (Aibel AS 2010a).

## 5.2 Component identification

ConocoPhillips uses a TAG system to identify machines and components installed on the various facilities the company operates. The TAG system used by ConocoPhillips are based on identification of department, facility, and main group of machinery. Further down it will have specific group of machinery and at last numbers in sequence. E.g. BD/EKOM/840/19 07010 is explained under:

- BD – Norwegian Department.
- EKOM - Ekofisk M.
- 840 – Main group for material handling.
- 19 – Sub group for lifting and material handling equipment.
- 07010 – Numbers in sequence.

The SWL 25 T Cranes are tagged with BD/EKOM/840/19 07010 and 07015 and the SWL 15 T Cranes are tagged similar ending with 07020 and 07025 (ConocoPhillips 2018d). The trivial five number sequence are used for reference for the sake of convenience. E.g. 07010, 07015, 07020 and 07025.

Similar, other components will have other subgroups, relevant for analysis are (ConocoPhillips 2013):

- 19 - Lifting and material handling equipment.
- 27 – Electrical power consuming equipment.
- 28 – Electrical power distribution equipment.
- 30 – Electrical motors.
- 43 - Instruments.
- 63 – Gearbox, Power transmission equipment.

According to ConocoPhillips (2018a), which is governing documents for ConocoPhillips, equipment shall be subjected to an evaluation of consequence classification for the factors of safety, environment, and production costs according to matrix found in appendix B. Data from SAP shows all tags under these cranes to hold a negligible to medium consequence classification.

## 5.3 Corrective Maintenance

CM is registered in SAP as notifications. A notification contains information about TAG no., type of notification, criticality, description of notification, etc. There are two main types of notification: M1, which is a maintenance request and ZT, which is a notification generated based on control reports from enterprise of competence.

The notifications are prioritized after a risk matrix and given a letter or number of E or 1-3, where the different deadlines are:

- E – Rectify in 14 days.
- 1 – Rectify in 3 months.
- 2 – Rectify in 6 months.
- 3 – Rectify in 12 months.

A M1 notification is generated when an operator is submitting an observation or deviation. The operator will write a description of the state of the equipment or machine and the priority of the notification. This notification will be assessed and a work order describing the work to be done will be issued. The ZT notification is given by the enterprise of competence with a firm deadline for continued use of the equipment or machine (ConocoPhillips 2016).

## 5.4 Preventive Maintenance

ConocoPhillips (2017) states PM programs shall in general be made from the manufacturers IOM manual and recommendations. If such recommendations do not exist, RCM and Failure Mode Effect and Criticality Analysis (FMECA) shall be performed in order to develop a PM program. Such analysis shall never be performed on equipment with low consequence of failure.

The PM program for the cranes are built up of a hierarchy where one will find:

- Work Standard (WS).
- Task List (TL).
- Maintenance Item (MI).
- Maintenance Plan (MP).
- Functional location.

WS is a description of the work to be performed for the different maintenance tasks. The WS can be added to one or more TL.

TL is a collection of maintenance tasks. General or specific for one type of equipment. Every TL is established with time estimates, frequency, and if needed: automatic ordering of material or external personnel, and at last executing discipline.

MI is used to make a connection between the TL and the specific equipment or collection of equipment; called functional location, which could be a large machine, e.g. a complete crane or a smaller item, e.g. an electrical motor. One TL can be connected to several MI, and one functional location could hold multiple MI.

MP is the maintenance plan; the MP is either based on calendar or operational time. For the purpose of the thesis work, only calendar-based plan is relevant, as the cranes do not have hour meters. For calendar-based maintenance the MP has a start date and interval (ConocoPhillips 2016).

The PM program, including both inspection and maintenance for the EOT Cranes are made from

recommendations and requirements stated in the IOM manual. After the modification work on the cranes in 2009, only one WS was revised and that was WS-19OVER45, the lubrication chart for 25T overhead crane (Gjerde 2018). A full overview over the PM program is shown in table 5.1. The WS texts are available in appendix D.

**Table 5.1:** PM program for EOT Cranes (Emmerhoff 2017).

<b>WS</b>	<b>Description</b>	<b>3M</b>	<b>6M</b>	<b>1Y</b>	<b>4Y</b>
WS-19OVER59	Inspection and lubrication of wire rope	X			
WS-19OVER30.E	Inspection of electrical crane		X		
WS-19OVER33.E	Functional test brake function		X		
WS-30MOTO68.M	El. Motors, control and ATEX control			X	
WS-19OVER45	Lubrication chart 25T overhead crane			X	X
WS-19OVER46	Lubrication chart 15T overhead crane			X	X
WS-19OVER32	Oil change overhead crane			X	X

In addition to the PM program. The cranes are subject of thoroughly periodical inspection every six months out of service or every twelve months by an enterprise of competence as per requirements in NORSOK R-003. Findings under these inspections will result in notifications (ConocoPhillips 2016).

## 6 Data analysis and results

This chapter contains the analysis steps and results. It is structured with one subsection per crane following the steps given in the methodology chapter.

### 6.1 25 T Crane 07010

25 Tonnes Crane with TAG BD/EKOM/840/19 07010.

#### 6.1.1 System selection and information collection

In the first step of the RCM analysis. Data was collected. One will find the generic data in chapter 5. The historic data, or notification history was sorted and put into the respective systems and subsystems.

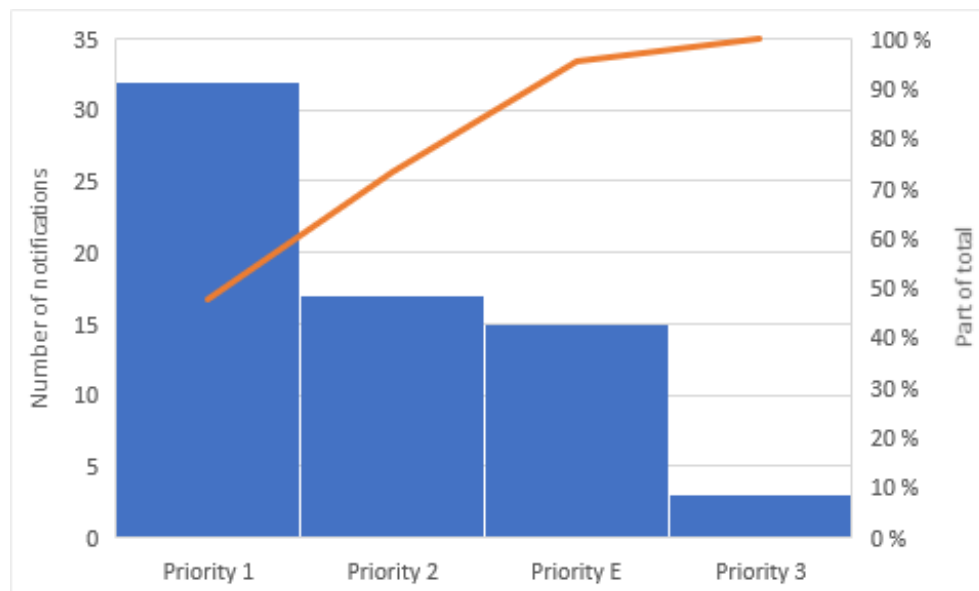

**Figure 6.1:** Notification per priority category 07010.

Figure 6.1 shows the priority of all the notifications on crane 07010 for the period of 2006 to 2017. Note that 80% of the notifications were of type 1 or 2.

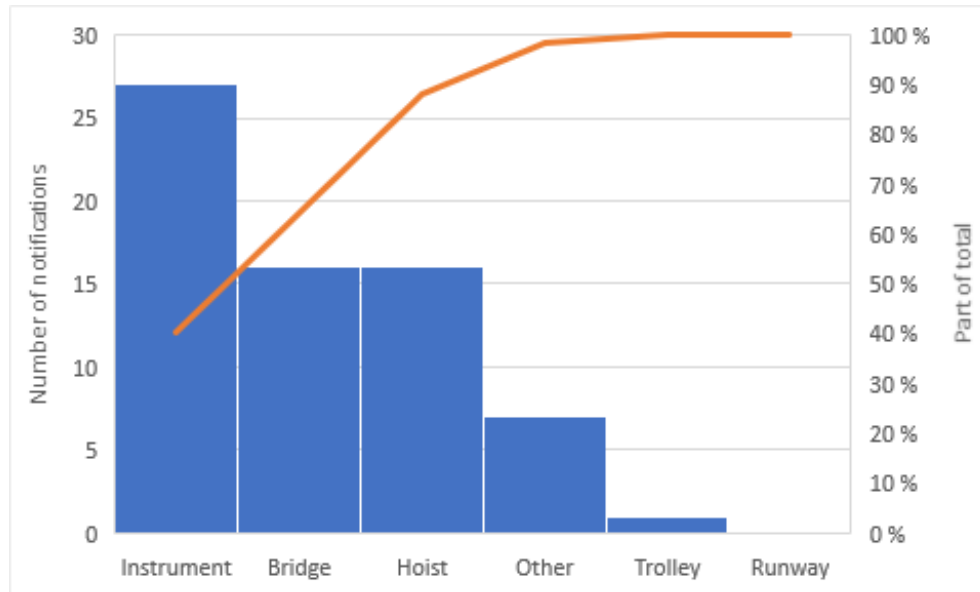

**Figure 6.2:** Pareto diagram for 07010.

Figure 6.2 shows the notifications portioned over the respective systems. Showing a great number of notifications with respect of instrument and bridge, in fact almost 80% of all notifications came from instrument or bridge. Looking further into the data a large quantity of notifications were about pendant in instrument system and bridge drive in the bridge system. Both subsystems had been modified: the bridge drive was modified, and a radio remote were installed. To facilitate this modifications figure 6.3 was made.



**Figure 6.3:** Revised pareto diagram for 07010.

After facilitating for modifications made, figure 6.3 was presented. Showing 80% notifications in instrument and hoist system. For instrument 80% of notifications were from the following subsystems (in given order): Overload switch, Anti-collision, Limit switch hoist, Electrical Protection Devices and Radio remote. For hoist 80% of the notifications are from the following sub-systems: Wire rope, Drum, Upper block, and Brake.

### 6.1.2 System boundary definition

The boundaries of the crane assembly as a system were defined at the electrical supply and structural support for runway beams in one end. The actual lifted load in the other end. The main components in the respective systems were for bridge: Girders, Bridge drive: Gearbox, Motor, etc., and cable tray. For hoist: Hoist drive, wire rope and block assembly. Instrument: Anti-collision, radio remote, limit switches and overload switch. For runway: runway beams and runway bridge travel rack. At last, the trolley had the following main components: Trolley drive, pinions, and wheels.

### 6.1.3 System description and functional block diagram

#### System description

Fortunately, Dreggen had made a functional description of the 25 T cranes in the functional description document Dreggen Crane AS (2004c). This functional description was incorporated in this analysis with some updates regarding the crane drive in the bridge, anti-collision system, and radio remote.

The Electrical Overhead Travelling Cranes are of underslung duobox special design for Ekofisk Platform 2/4M module W30. Both cranes are travelling on the same runway beams in north/south directions. Radio remote operates the cranes.

Main girders are made as box of plates and the end carriages are made of steel plates.

Cranes are made for Zone 1 hazardous area, all el. equipment are designed for Zone 1 and according to DNV, NPD, ATEX and FEM rules.

The crane is for offshore installations with ambient temperature - 20°C.

Main data:

- Capacity: 25 T.
- Span: 17000 mm.
- Height of lift: 9,5 m.
- Hoisting speed: 2,4 / 0,6 m/min.
- Trolley speed: 6 m/min.
- Crane speed: 6 m/min.
- Power Supply: 690 V / 60 Hz.
- Heel: Max. 1°.

Runway beams: HE550M based on max 5 m between supports.

The crane bridge is running on runway beams under flanges with eight (8) travel wheels. Four of these travel wheels are single flange type and mounted on one of the end carriage to obtain the horizontal travel guiding. Crane drive is equipped with explosion proof single speed electric motors with fail safe brakes through gear and pinion with cross shaft. Limit switches are installed

on the crane in addition to heavy duty bumpers in each end of the runway beams. Since the two cranes are travelling on the same runway beam the cranes are equipped with anti-collision proximity switch and actuator between the two cranes in addition to bumpers. Later it was added anti-collision measures by optical sensors as well.

Crane is equipped with electrical wire hoist with four wire falls. The hoist motor is two speed explosion proof design with fail safe brake. Overload switch and limit for top and bottom positions are included. Wire drum is grooved to ensure correct wire spooling on drum. Wire rope are galvanized and of non-rotating type.

The trolley is running on rails 60x60 mm situated on the top of main girders with six (6) travel wheels along duo-box main girder. Trolley is also equipped with four off guide rollers against rail on top of one main girder. Trolley drive is consisting of explosion proof single speed electric motor and fail-safe brake through gear and pinions with cross shaft. Limit switches are installed on the crane bridge in addition to heavy duty bumpers in each end of the crane.

No redundancy features are installed. The cranes are equipped with protection features in the form of limit switches for hoist, bridge and trolley, anti-collision system for crane bridge, overload protection switch for hoist, emergency stop, and fail-safe brakes on all drive motors; bridge, trolley, and hoist.

### Functional block diagram

A functional block diagram was made to illustrate the interaction between the different systems in the crane. Giving the boundaries with power, support, and lifted load, as well as internal power distribution, energy, and signals.

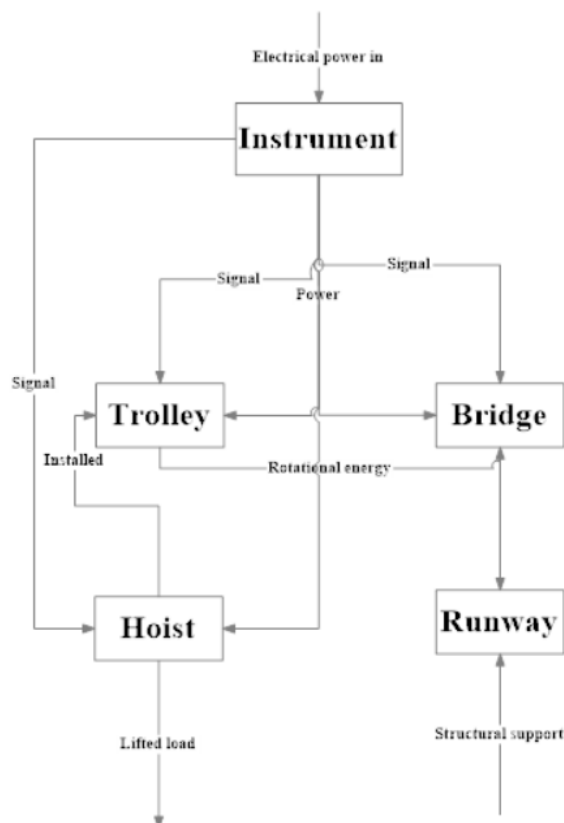

**Figure 6.4:** Functional block diagram.



### **IN/OUT Interfaces**

The IN/OUT interface list gave a description over the type of interface, e.g. power, energy, structural, the bounding system, interface location and reference drawing. As in the boundary definition it is defined that the boundary was given from electrical supply and runway supports to the actual handled load attached in the crane hook.

### **System work breakdown structure**

The SWBS was based on the TAG-lists retrieved from SAP and is found in appendix C. It contained the components registered in SAP today with some manual addition taken from both the historic data and the drawings in the crane documentation. This information was grouped in the following order: TAG NO, Description, System, Sub-system, Type (Instrument only), Quantity and reference. 10 tags were given a protection type and 5 were given a control type.

### **Equipment history**

The equipment history is a file compiled of the historic notification data from SAP. Usually the recommendation is to use history data from the last 2 or 3 years, in this case all the historic data accumulated on this machine was put into the equipment history, this was done because there was not a large quantity of data available. At least not for the last 2 or 3 years. The data were grouped on date, TAG, description, system, sub-system, failure mode and failure cause. Due to insufficient plotting of the data a large quantity of events lacked a good description of the actual cause of failure, and a large quantity of the data lacked a connection to the given TAG. Some assumptions had to be done to group the data into the right tag and system as well as the cause of failure.

For instance. The repeated false indication of the anti-collision system was assumed to be due to moisture on the lenses, this was stated in a single notification. The damage to the wire rope which occurs frequently was assumed to be of poor design, combined with human error.

#### **6.1.4 System functions and functional failures**

Based on the SWBS a system functions list was made, listing each component functions. These functions were assigned one, two or several possible functional failures.

E.g. The function of the bridge drive motors is to move the bridge. Possible functional failures were that the bridge is not moving, the bridge is stuttering when moving, the bridge is moving in the wrong direction or the bridge is moving against itself, i.e. the two bridge motors are running in opposite direction of each other.

The functions were based upon the OUT interface of handling the load attached in the crane hook. This is the main objective to the crane. Either this handling is up, down, north, south, east, or west. Functions were listed with the support of functional description, drawings, schematics, component manufactures documentation and the analysts understanding of this system.

When analysing data. Some discrepancies were identified in the documentation. The mark-up after the modification work done on the cranes in 2009, document no.: EKOM-VA-E-00003-001 revision 02B and E900-11915-E-000084-0002 revision 03 indicates different positions on the

sensors for the crane. The first drawing EKOM-VA-E-00003-001 is given a status "as installed" and the assumption is that this drawing has to be the right one.

### 6.1.5 Failure mode and effects analysis

Prior to the FMEA an equipment-functional failure matrix made based on the functional failures identified in step 4. This equipment-functional failure matrix had initially 129 failure modes which in terms would lead to 23 unique functional failures.

During the FMEA it was observed that several of the failure modes could lead to several functional failures. The number of failure modes which lead to unique functional failures was lowered to 74.

Some functional failures were removed from the equipment-functional failure matrix and were indicated with the letter "O". This was functional failures where the equipment had changed drastically. E. g. several failure modes were given to the functional failure *6.3 Bridge moving in wrong direction*, this is a failure which are not likely to suddenly happen without human intervention of some kind. Thus, it was removed from the analysis as there is no PM task which can be given to decrease the probability of the bridge moving in the wrong direction. The same logic was applied to *14.3 Hook moving in wrong direction* and *39.6 Trolley moving in wrong direction*.

### 6.1.6 Logic Tree Analysis

Based upon the FMEA, the LTA was performed. 37 Failure modes were given a letter A, for safety related functional failure. A large portion of this failure modes were attributed to instruments which were given a control or safety designation in the SWBS. Other failure modes were attributed to structure safety.

34 failure modes were given a designation letter B, meaning that these failure modes will give significant outage but pose small safety consequences. In this section one will identify the crane drive in the bridge, trolley drive in the trolley and junction boxes. Designation letter B is given to the equipment if there is significant outage; significant outage was defined as a momentary stop in the EOT crane when a well intervention campaign is being performed, given all the equipment which is mobilized for well intervention and the frequency the EOT cranes are used.

3 failure modes were assigned a D/C letter, meaning that this failure modes are hidden and causes small outage. This was the bridge bumper and heater element for the crane drive. Which will not pose a mediate treat to the reliability of the crane.

### 6.1.7 Task selection

The task selection step was performed in three sub-steps: Task selection process, sanity check and task comparison.

#### Task selection

The initial task selection process was performed in the order of the prioritized PM tasks accord-

ing to the LTA step. Due to the former established systems on bridge, hoist, instrument, other, runway and trolley the process and results are listed in the same manner. Several of the tasks are given the effective info comment of “A Part of annual control”, this is stated in the user manual (Dreggen Crane AS 2004a).

Where at least 3 data points in the equipment history was identified contributing to the same failure mode, reliability calculations by Weibull analysis were performed. For purpose of reliability calculations, a reliability rate of at least 80% was chosen. This rate was chosen as no definite requirements was identified in applicable rules, regulations, and standards.

### *Bridge*

For bridge-system the only grade A failure mode was related to the travel wheels. Structural failure in the travel wheels caused by massive degradation to structure. Task candidate was TD task of inspection and cleaning with estimate frequency of 1 year. This task is a part of annual control.

Other task part of annual control, selected TD task of inspection and cleaning, with the estimated frequency of 1 year were:

- Cable tray – FM: Bent, FC: Colliding into other structure.
- Motor Travel – FM: Brake not releasing, FC: Worn Brake.
- Travel wheels – FM: Deformed, FC: Bearing failure.

The Motor for travel was given a TD selective task of lubrication with grease gun every 4 year to prevent the FM: Motor bearing defective.

To prevent the FM: Motor cage or rotor defective, with the FC: Age. A TD selective task of inspection and cleaning was scheduled every 3 years. The user manual for the motors states a reference to IEC 60079-17 which gives 3 years as the largest interval to check Ex d – Explosion-proof enclosures (Standard Norge 2016).

The gearboxes for travel were identified to have a FM of gearbox not rotating and a FC of broken gears. The selective PM task was a TD task for changing oil every 4 years, given by the user manual (Dreggen Crane AS 2004a).

Similar the drive pinion, drive chain and trolley gear rack were identified to have the FM of broken, by either FC: Missing or broken theets or aberration. The selective PM task was a TD task for lubrication every 1 year. The Drive chain would have an 80% reliability if changed within 450 days or 1,25 years. MTBF was 1736 days.

The Weibull plot in figure 6.5 is showing on the x-axis, the natural logarithmic of the cycles or in this case days between occurring failure modes. On the y-axis it is the natural logarithmic of an estimate of the portion of components which has failed by rank. Each blue dot is a data point from the equipment history and the line is a trend line based on the data points.

The bumper and heater elements in the travel motors were of category D/C and selective task for these were RTF.

### *Hoist*

Hoist system had 12 FM given a category A from the LTA, several of these FM were given TD tasks which are stated in the user manual to be a part of the annual control, and thus, had a given

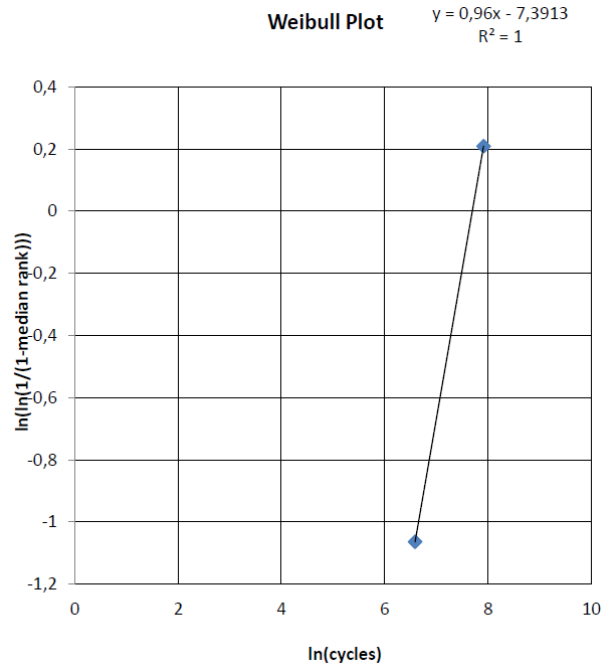

**Figure 6.5:** Weibull plot for drive chain 07010.

interval of 1 year:

- Motor hoist, FM: Brake not engaging, FC: Wear and tear.
- Block double, FM: Severe structural corrosion, FC: Lack of sufficient cross section in axle.
- Upper block, FM: Severe structural corrosion, FC: Lack of sufficient cross section in axle.
- Wire end connection outer, FM: Broken, FC: Broken because of misuse or severe deterioration.
- Wire end connection outer, FM: Corroded, FC: Moisture.
- Wire end connection inner, FM: Broken, FC: Broken because of misuse or severe deterioration.
- Wire end connection inner, FM: Corroded, FC: Moisture.

Gearbox intermittent had a FM of gearbox not rotating, FC was broken gears. A selective TD task was to change oil every 1 year. Dreggen had stated oil change every 4 years, though the gearbox OEM had stated oil change every 1 year.

Gearbox main had a FM of gearbox not rotating, FC was broken gears. A selective TD task was to check oil level every 1 year and change oil every 4 years.

Wire rope FM: Broken and Corroded, with applicable FC: Broken because of severe misuse or deterioration, Lack of lubrication. For the first FM selective TD tasks were inspection of the wire rope every 1 month and changing the wire rope every 3 months. If the wire rope was changed every three months, it would have a reliability rate of 83,83% and a MTBF of 292 days.

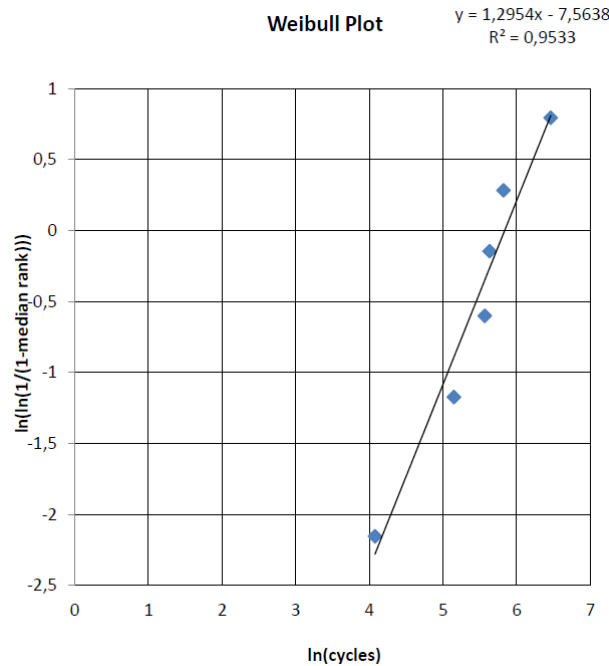

**Figure 6.6:** Weibull plot for wire rope 07010.

The FM not installed was deemed not applicable, as the wire rope will not go missing suddenly. The FM of lack of lubrication was given a selective TD task for inspection of wire rope every 1 month and lubrication every 3 month, though this would not be applicable if the wire rope is changed every 3 months.

For the hoist system 5 FM were identified and classified as category B in the LTA. The drive motor had an identified FM: Motor bearing defective, FC: Insufficient lubrication. The selective TD task of lubrication with grease gun every 4 years was chosen. Both the upper block and the lower block had an identified FM: Corrosion in bearings, FC: Water penetration in bearings. The selective TD task of lubrication with grease gun every 3 months were chosen to prevent water penetration.

The drive motor had an identified FM: Motor cage or rotor defective, FC: Age. This was like the bridge travel motors. An inspection of explosion proof motors must be done at least every 3 years. Thus, the selective TD task was inspection and clean every 3 years.

The last identified FM for the motors and hoist system was brake not releasing, FC: Worn brake. This FM were given a selective TD PM task of inspection and cleaning every year. This is a part of annual control.

#### *Instrument*

The Instrument system had 18 identified FM which were given a designation A in the LTA.

The anti-collision subsystem, and component laser had two identified FM of Dirty due to lack of cleaning and broken due to moisture. Based on meetings with ConocoPhillips and looking through the pareto and equipment history the understanding was that there was something wrong with these lasers quite often. Either it was moisture or dirt but fogging by moisture seemed to be a repeating problem. Thus, a selective TD PM task was to inspect and clean every 3 months. A modification by installing heat tracing in the areas around the laser should be considered.

Instrument and junction box (JB) OEMs had been observed to writes little or nothing in the user instructions about maintenance, and the little which was written was observed to state a reference to IEC 60079-17, which in terms are giving an instruction to inspect at least every 3 years. Using historic data and discussions from meetings, water penetration was a larger issue than to be inspected every 3 years. Thus, the selective task for several of the instruments would be a TD PM task of inspection and cleaning every 1 year. Applicable to the following components, FM, and FC:

- JB Switch anti-coll. FM: Shorted, FC: Shorted because of moisture - Connection broken.
- JB Anti-collision. FM: Shorted, FC: Shorted because of moisture - Connection broken.
- Switch pos. crane travel – FM: False indication, FC: Age.
- Switch pos. crane travel – FM: Broken, FC: Moisture in the electronics.
- Push button station – FM: Shorted, FC: Moisture.
- Switch emergency stop – FM: Shorted, FC: Moisture.
- Panel control, or radio remote – FM: Shorted, FC: Moisture.
- Switch pos. trolley travel – FM: False indication, FC: Age.
- Switch pos. trolley travel – FM: Broken, FC: Moisture.
- Switch pos. hoist – FM: False indication, FC: Age.
- Overload switch – FM: False indication, FC: Moisture in the electronics.

Special for the push button station was the panel control, or radio remote had taken over its main function, and the push button station was redeemed to emergency operation. Prior to this change, the push button station would have an 80,36% reliability at 265 days operating. With MTBF 341 days.

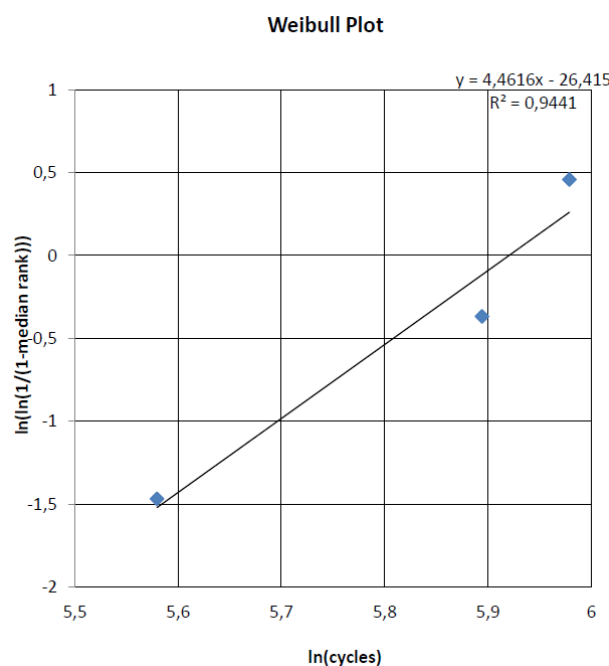

**Figure 6.7:** Weibull plot for push button station 07010.

The limit switch for the hoist with the failure mode of incorrect setting would have a reliability of 80% if the limits were checked using the interval of 140 days. 90 days interval would give a reliability of 86%. MTBF was 813 days. A TD PM task of verification of the limits were scheduled for every 3 months.

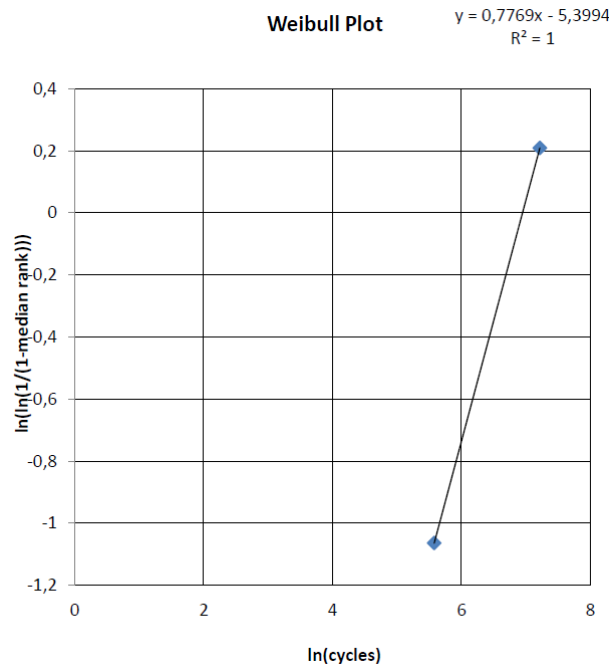

**Figure 6.8:** Weibull plot for limit switch hoist 07010.

The overload switch for the hoist with the FM of incorrect setting would have a reliability of 82,60% if the selective TD PM task of verifying the limits was performed every 9 months. MTBF was 997 days.

9 failure modes for instrument were categorized B in the LTA. FM Missing for the laser reflector element for the anti-collision subsystem was given a selective task of inspection and cleaning every 3 months. This would give the operator a chance to discover if the reflectors were missing prior to usage of the cranes.

The rest of the failure modes for instrument were like the instruments and junction boxes stated under the category A failure modes and would give a selective TD PM task of inspection and cleaning once a year:

- Temperature sensor travel motor – FM: Shorted, FC: Age.
- Temperature sensor travel motor – FM: False indication, FC: Age.
- Junction box – FM: Shorted, FC: Moisture.
- Box Junction overhead – FM: Shorted, FC: Moisture.
- Main switch – FM: Shorted, FC: Moisture.

*Other*

In the system of other the only item was the pad eye for test, FM: overstress and FC: Tear out due to loss of cross section. It was given a selective TD PM task checking for wear and tear every year, though this is a part of annual control.



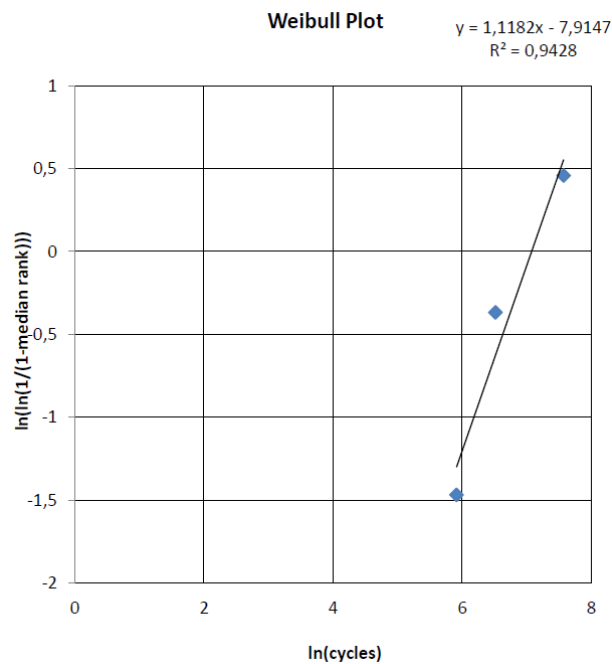

**Figure 6.9:** Weibull plot for overload switch hoist 07010.

### *Runway*

In the system of Runway, the Runway beams were listed with a FM: Severe structural corrosion and FC: Lack of sufficient cross section in structural supports. This was a category A failure mode. The selective TD PM task was inspection and cleaning every year, though this is a part of annual control.

The bridge gear rack was listed with a FM: Broken, FC: Missing rack theets. This failure mode was given a selective TD PM task of lubrication every year, such as stated in the user instructions. This was category B.

### *Trolley*

The trolley system was identified with 1 category A failure mode and 6 category B. Trolley wheels with FM: Severe structural corrosion and FC: Loss of sufficient cross section in axle was the category A failure mode. A selective TD PM task of inspection and cleaning was chosen with an interval of one year. This is a part of the annual control.

Similar the Trolley wheels with FM: Deformed, FC: Bearing failure was given the same selective TD PM task and interval, as it is a part of the annual control, though. This was a category B failure mode.

The motor for the trolley drive with FM: Motor bearing defective and FC: Insufficient lubrication was given the same selective TD PM task as the other motor bearing failure modes: Lubrication with grease gun every 4 years. Similar for the trolley drive motor with FM: Motor cage or rotor

defective, the same selective TD PM task was chosen as for the other motor cage or defective rotor failure modes: Inspect and clean every 3 years. The FM: Brake not releasing with FC: Worn brake had the same similarity and a part of the annual control, the selective TD PM task of inspection and cleaning every year was given.

The gearbox for the travel drive were identified with FM: Gearbox not rotating, FC: Broken gears. It was stated in the user manual to change the oil every 4 years, thus the selective TD PM task of changing the oil every 4 years was chosen.

The drive pinion with FM: Drive pinion not rotating, FC: Broken theets were like the drive pinions installed in the other systems and were stated in the user manual to be lubricated once a year. The drive pinion was given the selective TD PM task of lubrication every year.

### **Sanity check**

3 functional failures were put on the RTF list and checked in the sanity check. This was the bumper and the two heaters for bridge travelling. The bumper passed through the sanity check and got a continued RTF recommendation.

The two heaters for bridge travelling were observed to have both OEM conflicts and regulatory conflict. The OEM conflict were based on the maintenance instructions given in the user manual for the heater element. The regulatory conflict was ATEX requirement (Standard Norge 2016). Thus, selective TD PM task for the heater elements were to check for external damage every 3 months and internal damage every 6 months.

### **Task comparison**

Comparing the RCM scheduled tasks against the current PM program revealed some differences. Some of the components could not be identified to be covered by the current PM program, though this did mean that these components were not a subject to maintenance, just that the descriptions available did not cover maintenance to these components. The identified PM tasks were described with their respective WS covering this task. The intervals given in the current PM program varied some from the intervals chosen in the RCM tasks. The tasks comparisons are given in the following tables.

**Table 6.1:** Task comparison 07010 bridge system.

TAG	Component Description	FM#	Failure Mode	RCM Selection Dec.	Est Freq.	Current Task Description	Freq.
BD/EKOM/27	CABLE TRAY	3.1	Bent	1. Check for wear and tear or deformation - TD	1Y	WS-19OVER30.M	6M
23857	HEATER ELEMENT	4.1	Shorted	1. Inspect for external damage. - TD	1. 3M	WS-30MOTO68.E	1Y
BD/EKOM/27	MOTOR 30 07012			2. Open and check internally - TD	2. 6M		
23858	HEATER ELEMENT	5.1	Shorted	1. Inspect for external damage. - TD	1. 3M	WS-30MOTO68.E	1Y
BD/EKOM/30	MOTOR 30 07258			2. Open and check internally - TD	2. 6M		
07012	MOTOR TRAVEL E. CRANE OVERHEAD. 19 07010	6.1	Motor bearing defective	1. Lubricate with grease gun. - TD	4Y		
BD/EKOM/30	MOTOR TRAVEL E. CRANE OVERHEAD. 19 07010	6.2	Motor cage or rotor defective	1. Inspect and clean - TD	3Y	WS-30MOTO68.E	1Y
BD/EKOM/30	MOTOR TRAVEL E. CRANE OVERHEAD. 19 07010	6.3	Brake not releasing	1. Inspect and clean - TD	1Y		
BD/EKOM/30	MOTOR TRAVEL E. CRANE OVERHEAD. 19 07010	7.1	Motor bearing defective	1. Lubricate with grease gun. - TD	4Y		
BD/EKOM/30	MOTOR TRAVEL E. CRANE OVERHEAD. 19 07010	7.2	Motor cage or rotor defective	1. Inspect and clean - TD	3Y	WS-30MOTO68.E	1Y
07258	MOTOR TRAVEL E. CRANE OVERHEAD. 19 07010	7.3	Brake not releasing	1. Inspect and clean - TD	1Y		
BD/EKOM/30	MOTOR TRAVEL E. CRANE OVERHEAD. 19 07010	8.1	Gearbox not rotating	1. Change oil - TD	4Y	WS-19OVER45.M	4Y
BD/EKOM/63	GEARBOX. MOTOR TRAVELLING 30 07258	9.1	Gearbox not rotating	1. Change oil - TD	4Y	WS-19OVER45.M	4Y
BD/EKOM/63	GEARBOX. MOTOR TRAVELLING 30 07258	10.1	Drive pinion not rotating	1. Lubricate with burshed or sprayed on grease - TD	1Y	WS-19OVER45.M	1Y
07055	DRIVE PINION	11.1	Drive chain broken	1. Inspect, clean and lubricate - TD	1Y		
	DRIVE CHAIN	12.2	Structural failure	1. Inspect and clean - TD	1Y		
	TRAVEL WHEELS	12.1	Deformed	1. Inspect and clean - TD	1Y		
	TRAVEL WHEELS	13.1	Broken	1. Lubricate with burshed or sprayed on grease - TD	1Y	WS-19OVER45.M	4Y
	TROLLEY GEAR RACK						

**Table 6.2:** Task comparison 07010 hoist system.

TAG	Component Description	FM#	Failure Mode	RCM Selection Dec.	Est Freq.	Current Task Description	Freq.
BD/EKOM/30	MOTOR HOIST. CRANE OVERHEAD 19 07010	14.4	Brake not engaging	1. Inspect and clean - TD	1Y	WS-19OVER33.M	6M
BD/EKOM/30	MOTOR HOIST. CRANE OVERHEAD 19 07010	14.1	Motor bearing defective	1. Lubricate with grease gun. - TD	4Y		
BD/EKOM/30	MOTOR HOIST. CRANE OVERHEAD 19 07010	14.2	Motor cage or rotor defective	1. Inspect and clean - TD	3Y	WS-30MOTO68.E	1Y
BD/EKOM/30	MOTOR HOIST. CRANE OVERHEAD 19 07010	14.3	Brake not releasing	1. Inspect and clean - TD	1Y	WS-19OVER33.M	6M
	GEARBOX MOTOR HOIST INTERMITTENT	15.1	Gearbox not rotating	2. Change oil - TD	1Y	WS-19OVER45.M	4Y
	GEARBOX MOTOR HOIST MAIN	16.1	Gearbox not rotating	1. Verify oil level - TD	1. 1Y	WS-19OVER32.M/	1Y/4Y
				2. Change oil - TD	2. 4Y	WS-19OVER45.M	
BD/EKOM/19	BLOCK DOUBLE SHEAVE WITH HOOK	17.2	Severe structural corrosion	1. Inspect and clean - TD	1Y	WS-19OVER30.M	6M
BD/EKOM/19	BLOCK DOUBLE SHEAVE WITH HOOK	17.1	Corrosion in bearings	1. Lubricate with grease gun. - TD	3M	WS-19OVER59.M	3M
	UPPER BLOCK	18.2	Severe structural corrosion	1. Inspect and clean - TD	1Y	WS-19OVER30.M	6M
	UPPER BLOCK	18.1	Corrosion in bearings	1. Lubricate with grease gun. - TD	3M	WS-19OVER59.M	3M
BD/EKOM/19	WIRE 18 MM MIN BRUDD 32,9 T	19.1	Broken	1. Inspect wire rope	1. 1M	WS-19OVER59.M	3M
				2. Change wire rope	2. 3M		
BD/EKOM/19	WIRE 18 MM MIN BRUDD 32,9 T	19.3	Corroded	1. Inspect wire rope	1. 1M	WS-19OVER59.M	3M
02824				2. Lubricate wire rope	2. 3M		
	WIRE END CONNECTION OUTER	20.1	Broken	1. Inspect and clean - TD	1Y	WS-19OVER59.M	3M
	WIRE END CONNECTION	21.1	Broken	1. Inspect and clean - TD	1Y	WS-19OVER59.M	3M
	DRUM BEARINGS					WS-19OVER45.M	1Y

**Table 6.3:** Task comparison 07010 instrument system.

TAG	Component Description	FM#	Failure Mode	RCM Selection Dec.	Est Freq.	Current Task Description	Freq.
BD/EKOM/43 ZS-01852	SWITCH POS TROLLY OVERH CRANE 19 07010	35.2	Broken	1. Inspect and clean - TD	1Y		
BD/EKOM/43 ZS-01853	SWITCH POS TROLLY OVERH CRANE 19 07010	36.2	Broken	1. Inspect and clean - TD	1Y		
BD/EKOM/43 ZE-29556	ELEMENT POSITION REFLECTOR "A" 19 07010	22.1	Missing	1. Inspect and clean - TD	3M		
BD/EKOM/43 ZE-29557	ELEMENT POSITION REFLECTOR "B" 19 07010	23.1	Missing	1. Inspect and clean - TD	3M		
BD/EKOM/43 ZS-29173	SWITCH LIMIT LASER 19 07010	24.1	False indication	1. Inspect and clean - TD	3M		
BD/EKOM/43 ZS-29174	SWITCH LIMIT LASER 19 07010	25.1	False indication	1. Inspect and clean - TD	3M		
BD/EKOM/43 TY-07012	ELEM TEMP CONVERSION FOR MOTOR 30 07012	26.1	Shorted	1. Inspect and clean - TD	1Y		
BD/EKOM/43 TY-07258	ELEM TEMPE CONVERSION FOR MOTOR 30 07258	27.1	Shorted	1. Inspect and clean - TD	1Y		
BD/EKOM/28 JB-08238	JUNCTION BOX	28.1	Shorted	1. Inspect and clean - TD	1Y		
BD/EKOM/28 JE-07010	BOX JUNCTION OVERHEAD CRANE 19 07010	29.1	Shorted	1. Inspect and clean - TD	1Y		
BD/EKOM/43 JB-03961	JB OVERRIDE SWITCH ANTI COLL. 19-07010	30.1	Shorted	1. Inspect and clean - TD	1Y		
BD/EKOM/43 JB-03971	JUNCTION BOX EX ANTI COLLISION 19-07010	31.1	Shorted	1. Inspect and clean - TD	1Y		
BD/EKOM/43 ZS-01854	SWITCH POS TRAVEL OVERH CRANE 19 07010	32.1	False indication	1. Inspect and clean - TD	1Y	WS-19OVER30.M	6M
BD/EKOM/43 ZS-01855	SWITCH POS TRAVEL OVERH CRANE 19 07010	33.1	False indication	1. Inspect and clean - TD	1Y	WS-19OVER30.M	6M
BD/EKOM/43 ZS-01850	SW LIMIT HOOK POS OVERH CRANE 19 07010	34.1	False indication	1. Inspect and clean - TD	1Y	WS-19OVER30.M	6M
BD/EKOM/43 ZS-01850	SW LIMIT HOOK POS OVERH CRANE 19 07010	34.2	Incorrect setting	1. Verify limits - TD	3M	WS-19OVER30.M	6M
BD/EKOM/43 ZS-01852	SWITCH POS TROLLY OVERH CRANE 19 07010	35.1	False indication	1. Inspect and clean - TD	1Y	WS-19OVER30.M	6M
BD/EKOM/43 ZS-01853	SWITCH POS TROLLY OVERH CRANE 19 07010	36.1	False indication	1. Inspect and clean - TD	1Y	WS-19OVER30.M	6M
	OVERLOAD SWITCH HOIST	37.1	False indication	1. Inspect and clean - TD	1Y	WS-19OVER33.M	6M
	OVERLOAD SWITCH HOIST	37.2	Incorrect setting	1. Verify limits - TD	9M	WS-19OVER33.M	6M
BD/EKOM/28 07010	SWITCH MAIN FOR OVERHEAD CRANE 19 07010	38.1	Shorted	1. Inspect and clean - TD	1Y		
BD/EKOM/28 07011	SWITCH PUSH BUTTON STATION FOR 19 07010	39.1	Shorted	1. Inspect and clean - TD	1Y	WS-30MOTO68.E	1Y
BD/EKOM/28 08293	SWITCH EMERG STOP CRANE 19 07010	40.1	Shorted	1. Inspect and clean - TD	1Y		
BD/EKOM/28 LCP-07010	PANEL CONTROL. OVERHEAD CRANE 19 07010	41.1	Shorted	1. Inspect and clean - TD	1Y		

**Table 6.4:** Task comparison 07010 other system.

TAG	Component Description	FM#	Failure Mode	RCM Selection Dec.	Est Freq.	Current Task Description	Freq.
BD/EKOM/19 07558	PADEYE TEST SWL 35T (FOR OT CRANE )	42.1	Overstress	1. Check for wear and tear or deformation - TD	1Y		

**Table 6.5:** Task comparison 07010 runway system.

TAG	Component Description	FM#	Failure Mode	RCM Selection Dec.	Est Freq.	Current Task Description	Freq.
	BRIDGE GEAR RACK	43.1	Broken	1. Lubricate with burshed or sprayed on grease - TD	1Y	WS-19OVER30.M	6M
	RUNWAY BEAMS	44.1	Severe structural corrosion	1. Inspect and clean - TD	1Y	WS-19OVER30.M	6M

**Table 6.6:** Task comparison 07010 trolley system.

TAG	Component Description	FM#	Failure Mode	RCM Selection Dec.	Est Freq.	Current Task Description	Freq.
BD/EKOM/30 07011	TROLLEY TRAVEL WHEELS	45.1	Severe structural corrosion	1. Inspect and clean - TD	1Y	WS-19OVER30.M	6M
	TROLLEY TRAVEL WHEELS	45.2	Deformed	1. Inspect and clean - TD	1Y	WS-19OVER30.M	6M
BD/EKOM/30 07011	MOTOR TROLLEY. CRANE OVERHEAD 19 07010	13.1	Motor bearing defective	1. Lubricate with grease gun. - TD	4Y		
BD/EKOM/30 07011	MOTOR TROLLEY. CRANE OVERHEAD 19 07010	13.2	Motor cage or rotor defective	1. Inspect and clean - TD	3Y	WS-30MOTO68.E	1Y
BD/EKOM/30 07011	MOTOR TROLLEY. CRANE OVERHEAD 19 07010	13.3	Brake not releasing	1. Inspect and clean - TD	1Y		
	GEARBOX TROLLEY MOTOR	47.1	Gearbox not rotating	1. Change oil - TD	4Y		
	PINION TROLLEY DRIVE	48.1	Drive pinion not rotating	1. Lubricate with burshed or sprayed on grease - TD	1Y	WS-19OVER45.M	1Y
	BOOGIE WHEEL CONNECTION					WS-19OVER45.M	1Y

## 6.2 25 T Crane 07015

25 Tonnes Crane with TAG BD/EKOM/840/19 07015. This crane is identical to the one in section 6.1. Thus, this section will hold large similarities to section 6.1.

### 6.2.1 System selection and information collection

In the first step of the RCM analysis. Data was collected. One will find the generic data in chapter 5. The historic data, or notification history was sorted and put into the respective systems and subsystems.

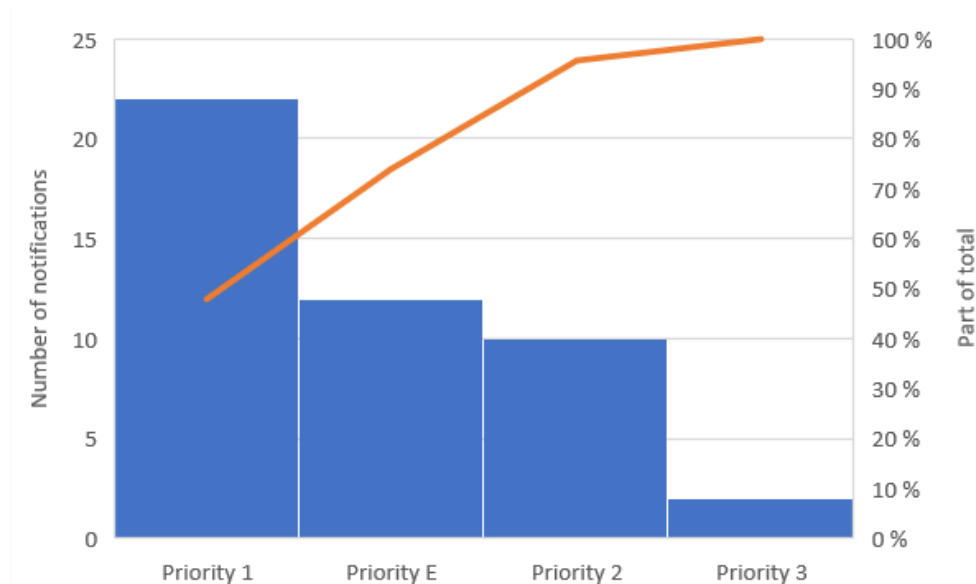

**Figure 6.10:** Notification per priority category 07015.

Figure 6.10 shows the priority of all the notifications on crane 07015 for the period of 2006 to 2017. Note that 80% of the notifications were of type 1 or E priority.

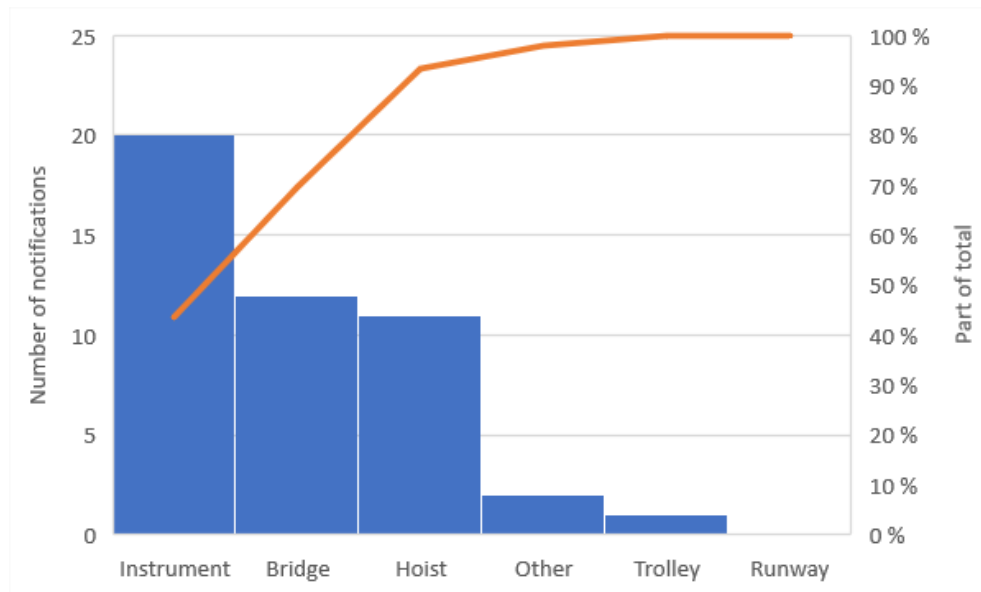

**Figure 6.11:** Pareto diagram for 07015.

Figure 6.11 shows the notifications portioned over the respective systems. Showing many notifications in the instrument and bridge system, in fact 80% of all notifications came from the instrument and bridge systems. Looking further into the data a large quantity of notifications was about anti-collision, limit switch hoist, pendant, electrical protection devices and overload switch for instrument and crane drive for bridge system. Both subsystems have been modified: the bridge drive was modified; a radio remote and anti-collision system were installed. To facilitate the modifications figure 6.12 was made.

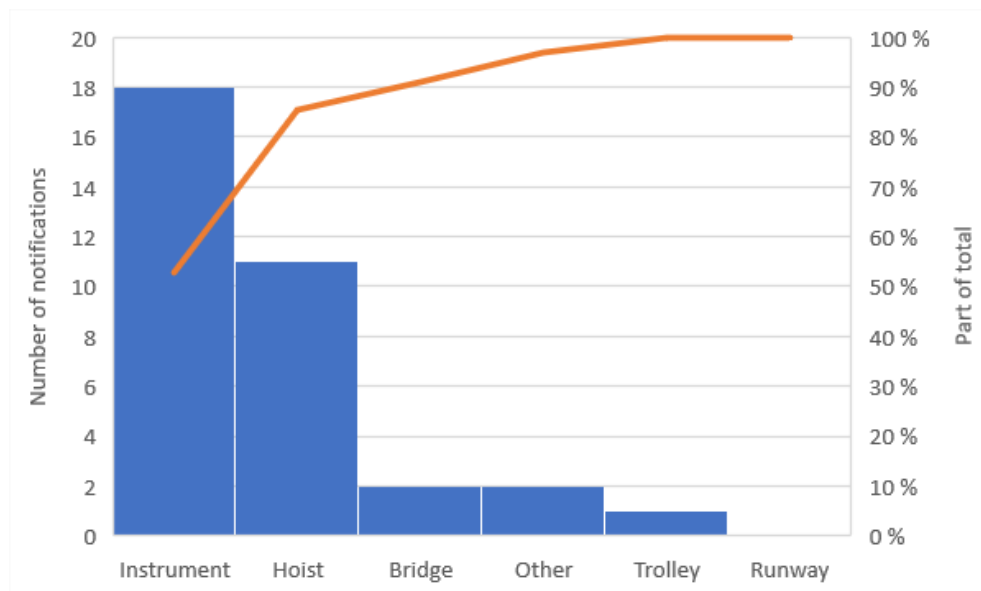

**Figure 6.12:** Revised pareto diagram for 07015.

After facilitating for modifications made, figure 6.12 was presented. Showing 80% of notifications in the instrument and hoist systems. For instrument 80% of the notifications were from anti-collision, limit switch hoist, electrical protection devices and overload switch. For the hoist 80% of the notifications were from wire rope and gear.

### 6.2.2 System boundary definition

The boundaries of the crane assembly as a system were defined at the electrical supply and structural supports for runway beams in one end. The actual lifted load in the other end. The main components in the respective systems were for bridge: Girders, Bridge drive: Gearbox, Motor, etc., and cable tray. For hoist: Hoist drive, wire rope and block assembly. Instrument: Anti-collision, radio remote, limit switches and overload switch. For runway: runway beams and runway bridge travel rack. At last, the trolley had the following main components: Trolley drive, pinions, and wheels.

### 6.2.3 System description and functional block diagram

#### System description

Fortunately, Dreggen had made a functional description of the 25 T cranes in the functional description document Dreggen Crane AS (2004c). This functional description was incorporated in this analysis with some updates regarding the crane drive in the bridge, anti-collision system, and radio remote.

The Electrical Overhead Travelling Cranes are of underslung duobox special design for Ekofisk Platform 2/4M module W30. Both cranes are travelling on the same runway beams in north/south directions. Radio remote operates the cranes.

Main girders are made as box of plates and the end carriages are made of steel plates.

Cranes are made for Zone 1 hazardous area, all el. equipment are designed for Zone 1 and according to DNV, NPD, ATEX and FEM rules.

The crane is for offshore installations with ambient temperature - 20°C.

Main data:

- Capacity: 25 T.
- Span: 17000 mm.
- Height of lift: 9,5 m.
- Hoisting speed: 2,4 / 0,6 m/min.
- Trolley speed: 6 m/min.
- Crane speed: 6 m/min.
- Power Supply: 690 V / 60 Hz.
- Heel: Max. 1°.

Runway beams: HE550M based on max 5 m between supports.

The crane bridge is running on runway beams under flanges with eight (8) travel wheels. Four of these travel wheels are single flange type and mounted on one of the end carriage to obtain the horizontal travel guiding. Crane drive is equipped with explosion proof single speed electric motors with fail safe brakes through gear and pinion with cross shaft. Limit switches are installed



on the crane in addition to heavy duty bumpers in each end of the runway beams. Since the two cranes are travelling on the same runway beam the cranes are equipped with anti-collision proximity switch and actuator between the two cranes in addition to bumpers. Later it was added anti-collision measures by optical sensors as well.

Crane is equipped with electrical wire hoist with four wire falls. The hoist motor is two speed explosion proof design with fail safe brake. Overload switch and limit for top and bottom positions are included. Wire drum is grooved to ensure correct wire spooling on drum. Wire rope are galvanized and of non-rotating type.

The trolley is running on rails 60x60 mm situated on the top of main girders with six (6) travel wheels along duo-box main girder. Trolley is also equipped with four off guide rollers against rail on top of one main girder. Trolley drive is consisting of explosion proof single speed electric motor and fail-safe brake through gear and pinions with cross shaft. Limit switches are installed on the crane bridge in addition to heavy duty bumpers in each end of the crane.

No redundancy features are installed. The cranes are equipped with protection features in the form of limit switches for hoist, bridge and trolley, anti-collision system for crane bridge, overload protection switch for hoist, emergency stop, and fail-safe brakes on all drive motors; bridge, trolley, and hoist.

### **Functional block diagram**

A functional block diagram (please see figure 6.4) was made to illustrate the interaction between the different systems in the crane. Giving the boundaries with power, support, and lifted load, as well as internal power distribution, energy, and signals.

### **IN/OUT Interfaces**

The IN/OUT interface list gave a description over the type of interface, e.g. power, energy, structural, the bounding system, interface location and reference drawing. As in the boundary definition it is defined that the boundary was given from electrical supply and runway supports to the actual handled load attached in the crane hook.

### **System work breakdown structure**

The SWBS was based on the TAG-lists retrieved from SAP and found in appendix C. It contained the components registered in SAP today with some manual addition taken from both the historic data, the drawings in the crane documentation and previous analysis; drum bearings were identified in the previous analysis and implemented in the SWBS in this analysis. The SWBS was grouped in the following order: TAG No., Description, System, Sub-system, Type (Instrument only), Quantity and reference. 10 tags were given a protection type and 5 were given a control type.

### **Equipment history**

The equipment history is a file compiled of the historic notification data from SAP. Usually the recommendation is to use history data from the last 2 or 3 years, in this case all the historic data accumulated on this machine were put into the equipment history, this was done because there is not a large quantity of data available. At least not for the last 2 or 3 years. The data was grouped

on date, TAG, description, system, subsystem, failure mode and failure cause. Due to insufficient plotting of the data a large quantity of events lacked a good description of the actual cause of failure, and a large quantity of the data lacked a connection to the given TAG. Some assumptions had to be done to group the data into the right tag and system as well as the cause of failure.

For instance. The repeated false indication of the anti-collision system is assumed to be due to moisture on the lenses, this was stated in a single notification. The damage to the wire rope which occurs frequently was assumed to be of poor design, combined with human error.

#### **6.2.4 System functions and functional failures**

Based on the system work breakdown structure a system functions list was made, listing each component functions. These functions were assigned one, two or several possible functional failures.

E.g. The function of the bridge drive motors is to move the bridge. Possible functional failures were that the bridge is not moving. Several of the functional failures used in analysis in section 6.1 were removed as they did not add any value to the analysis.

The functions were based upon the OUT interface of handling the load attached in the crane hook. This is the main objective to the crane. Either this handling is up, down, north, south, east, or west. Functions were listed with the support of functional description, drawings, schematics, component manufactures documentation and the analysts understanding of this system.

When analysing data. Some discrepancies were identified in the documentation. The mark-up after the modification work done on the cranes in 2009, document no.: EKOM-VA-E-00003-001 revision 02B and E900-11915-E-000084-0002 revision 03 indicates different positions on the sensors for the crane. The first drawing EKOM-VA-E-00003-001 was given a status "as installed" and the assumption was that this drawing had to be the right one.

#### **6.2.5 Failure mode and effects analysis**

Prior to the FMEA an equipment-functional failure matrix was made based on the functional failures identified in step 4. This equipment-functional failure matrix had initially 86 failure modes which in terms would lead to 17 unique functional failures.

During the FMEA it was observed that several of the failure modes could lead to several functional failures. The number of failure modes which lead to unique functional failures was lowered to 75.

Both the functional failures and the failure modes identified as not applicable in section 6.1 was removed in this analysis.

#### **6.2.6 Logic Tree Analysis**

Based upon the FMEA, the LTA was performed. 38 Failure modes were given a letter A, for safety related functional failure. A large portion of this failure modes were attributed to instru-

ments which were given a control or safety designation in the SWBS. Other failure modes were attributed to structure safety.

34 failure modes were given a designation letter B, meaning that these failure modes will give significant outage but pose small safety consequences. In this section one will identify the crane drive in the bridge, trolley drive in the trolley and junction boxes. Designation letter B is given to the equipment if there is significant outage; significant outage was defined as a momentary stop in the EOT crane when a well intervention campaign is being performed, given all the equipment which is mobilized for well intervention and the frequency the EOT cranes are used.

3 failure modes were assigned a D/C letter, meaning that this failure modes were hidden and causes small outage. This was the bridge bumper and heater element for the crane drive. Which will not pose a mediate treat to the reliability of the crane.

### 6.2.7 Task selection

The task selection step was performed in three sub-steps: Task selection process, sanity check and task comparison.

#### Task selection

The initial task selection process were performed in the order of the prioritized PM tasks according to the LTA step. Due to the former established systems on bridge, hoist, instrument, other, runway and trolley the process and results will be listed in the same manner. Several of the tasks were given the effective info comment of “A Part of annual control”, this is stated in the user manual (Dreggen Crane AS 2004a).

Where at least 3 data points in the equipment history was identified contributing to the same failure mode, reliability calculations by Weibull analysis were performed. For purpose of reliability calculations, a reliability rate of at least 80% was chosen. This rate was chosen as there were no definite requirements identified in applicable rules, regulations, and standards.

#### *Bridge*

For bridge-system the only grade A failure mode was related to the travel wheels. Structural failure in the travel wheels caused by massive degradation to structure. Task candidate was TD task of inspection and cleaning with estimate frequency of 1 year. This task is a part of annual control.

Other task part of annual control, selected TD task of inspection and cleaning, with the estimated frequency or 1 year were:

- Cable tray – FM: Bent, FC: Colliding into other structure.
- Motor Travel – FM: Brake not releasing, FC: Worn Brake.
- Travel wheels – FM: Deformed, FC: Bearing failure.

The Motor for travel was given a TD selective task of lubrication with grease gun every 4 year to prevent the FM: Motor bearing defective.

To prevent the FM: Motor cage or rotor defective, with the FC: Age. A TD selective task of inspection and cleaning was scheduled every 3 years. The user manual for the motors states a

reference to IEC 60079-17 which gives 3 years as the largest interval to check Ex d – Explosion-proof enclosures (Standard Norge 2016).

The gearboxes for travel were identified to have a FM of gearbox not rotating and a failure cause of broken gears. The selective PM task was a TD task for changing oil every 4 years, given by the user manual (Dreggen Crane AS 2004a).

Similar the drive pinion, drive chain and trolley gear rack were identified to have the FM of broken, by either FC: Missing or broken theets or aberration. The selective PM task was a TD task for lubrication every 1 year.

The bumper was of category D/C and selective task for these were RTF.

### Hoist

Hoist system had 10 FM given a category A from the LTA.

Gearbox intermittent had a FM of gearbox not rotating, FC was broken gears. A selective TD task was to change oil every 1 year. Dreggen stated oil change every 4 years, though the gearbox OEM stated oil change every 1 year.

Gearbox main had a FM of gearbox not rotating, FC was broken gears. A selective TD task was to check oil level every 1 year and change oil every 4 years. The gearbox main would have a 90,71% reliability if oil was changed and gearbox was inspected every 4 years. MTBF was 1811 days.

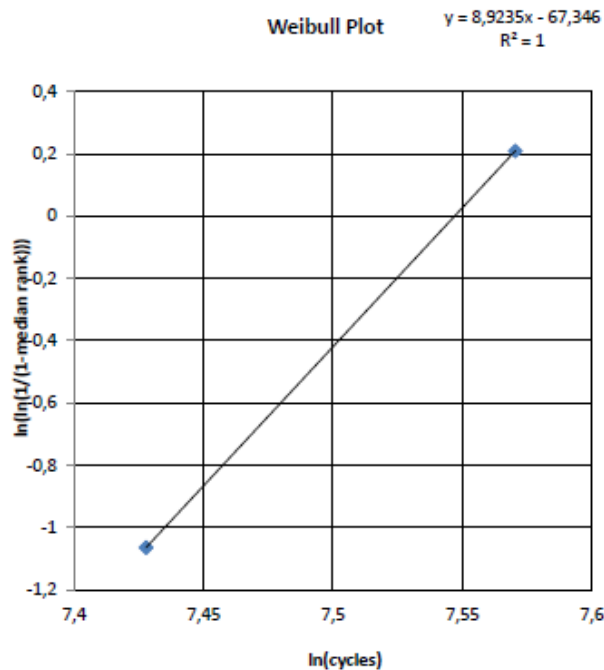
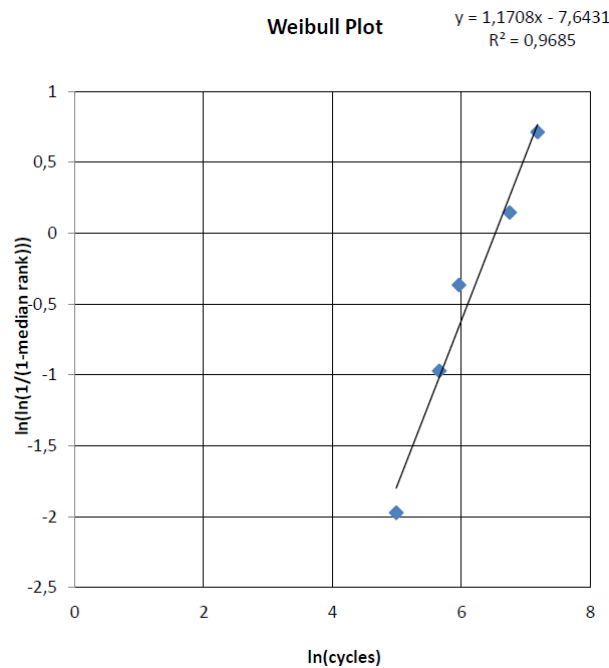

**Figure 6.13:** Weibull plot for gear 07015.

The Weibull plot in figure 6.13 is showing on the x-axis, the natural logarithmic of the cycles or in this case days between occurring failure modes. On the y-axis it is the natural logarithmic of

an estimate of the portion of components which has failed by rank. Each blue dot is a data point from the equipment history and the line is a trend line based on the data points.

Wire rope FM: Broken and Corroded, with applicable FC: Broken because of severe misuse or deterioration, Lack of lubrication. For the first FM selective TD tasks were inspection of the wire rope every 1 month and changing the wire rope every 6 months. If the wire rope was changed every six months, it would have a reliability rate of 81,10% and a MTBF of 599 days.



**Figure 6.14:** Weibull plot for wire rope 07015.

The FM of lack of lubrication was given a selective TD task for inspection of wire rope every 1 month and lubrication every 3 month.

Several of these FM were given TD tasks which were stated in the user manual to be a part of the annual control, and thus, had a given interval of 1 year:

- Wire end connection outer, FM: Broken, FC: Broken because of misuse or severe deterioration.
- Wire end connection inner, FM: Broken, FC: Broken because of misuse or severe deterioration.
- Motor hoist, FM: Brake not engaging, FC: Wear and tear.
- Block double, FM: Severe structural corrosion, FC: Lack of sufficient cross section in axle.
- Upper block, FM: Severe structural corrosion, FC: Lack of sufficient cross section in axle.

Drum bearings were added because of the task comparison from 07010. Drum bearings were given the selective TD PM task of lubrication with gears every year.

For the hoist system 5 FM were identified and classified as category B in the LTA. The drive motor had an identified FM: Motor bearing defective, FC: Insufficient lubrication. The selective TD task of lubrication with grease gun every 4 years were chosen.

The drive motor had an identified FM: Motor cage or rotor defective, FC: Age. This was like the bridge travel motors. An inspection of explosion proof motors must be done at least every 3 years. Thus, the selective TD task was inspection and clean every 3 years. The last identified FM for the motors and hoist system was brake not releasing, FC: Worn brake. This FM was given a selective TD PM task of inspection and cleaning every year. This is a part of annual control.

Both the upper block and the lower block had an identified FM: Corrosion in bearings, FC: Water penetration in bearings. The selective TD task of lubrication with grease gun every 3 month were chosen to prevent water penetration.

*Instrument*

The Instrument system had 17 identified FM which were given a designation A in the LTA.

The anti-collision subsystem, and component laser had two identified FM of Dirty due to lack of cleaning and broken due to moisture. Based on meetings with ConocoPhillips and looking through the pareto and equipment history the understanding was that there was something wrong with these lasers quite often. Either it was moisture or dirt but fogging by moisture seemed to be a repeating problem. Thus, a selective TD PM task was to inspect and clean every 3 months. A modification by installing heat tracing in the areas around the laser should be considered. The lasers would have a reliability of 80,24% if cleaning and inspection was done every 46 days. MTBF was equal to 456 days.

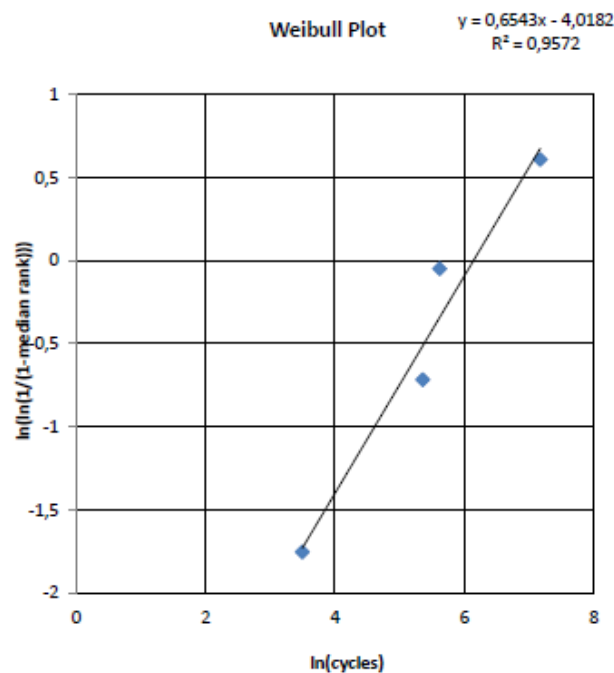

**Figure 6.15:** Weibull plot for anti-collision system 07015.

Instrument and junction box (JB) OEMs has been observed to writes little or nothing in the user instructions about maintenance, and the little which was written was observed to state a reference to IEC 60079-17, which in terms was giving instructions to inspect at least every 3 years. Using historic data and discussions from meetings, water penetration was a larger issue than to be inspected every 3 years. Thus, the selective task for several of the instruments would be a TD

PM task of inspection and cleaning every 1 year. Applicable to the following components, FM, and FC:

- JB Switch anti-coll. FM: Shorted, FC: Shorted because of moisture - Connection broken.
- JB Anti-collision. FM: Shorted, FC: Shorted because of moisture - Connection broken.
- Switch pos. crane travel – FM: False indication, FC: Age.
- Switch pos. crane travel – FM: Broken, FC: Moisture in the electronics.
- Push button station – FM: Shorted, FC: Moisture.
- Switch emergency stop – FM: Shorted, FC: Moisture.
- Panel control, or radio remote – FM: Shorted, FC: Moisture.
- Switch pos. trolley travel – FM: False indication, FC: Age.
- Switch pos. trolley travel – FM: Broken, FC: Moisture.
- Switch pos. hoist – FM: False indication, FC: Age.
- Overload switch – FM: False indication, FC: Moisture in the electronics.

The limit switch for the hoist with the failure mode of incorrect setting would have a reliability of 80,14% if the limits were checked using the interval of 165 days. 90 days interval would give a reliability of 86,87%. MTBF was 1055 days. A TD PM task of verification of the limits were scheduled for every 3 months.

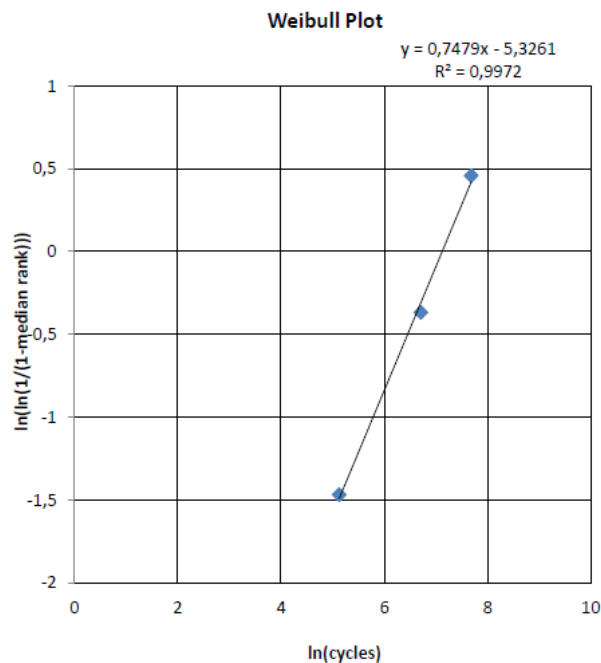

**Figure 6.16:** Weibull plot for limit switch hoist 07015.

The overload switch for the hoist with the FM of incorrect setting was given the selective TD PM task of verifying the limits was performed every 9 months. This was based on reliability data from analysis of 07010.



9 failure modes for instrument were categorized B in the LTA. FM Missing for the laser reflector element for the anti-collision subsystem was given a selective task of inspection and cleaning every 3 months. This would give the operator a chance to discover if the reflectors are missing prior to usage of the cranes.

The rest of the failure modes for instrument were like the instruments and junction boxes stated under the category A failure modes and would give a selective TD PM task of inspection and cleaning once a year:

- Temperature sensor travel motor – FM: Shorted, FC: Age.
- Temperature sensor travel motor – FM: False indication, FC: Age.
- Junction box – FM: Shorted, FC: Moisture.
- Box Junction overhead – FM: Shorted, FC: Moisture.
- Main switch – FM: Shorted, FC: Moisture.

#### *Runway*

In the system of Runway, the Runway beams were listed with a FM: Severe structural corrosion and FC: Lack of sufficient cross section in structural supports. This was a category A failure mode. The selective TD PM task was inspection and cleaning every year, though this is a part of annual control.

The bridge gear rack was listed with a FM: Broken, FC: Missing rack theets. This failure mode was given a selective TD PM task of lubrication every year, such as stated in the user instructions. This was category B.

#### *Trolley*

The trolley system was identified with 1 category A failure mode and 6 category B. Trolley wheels with FM: Severe structural corrosion and FC: Loss of sufficient cross section in axle is the category A failure mode. A selective TD PM task of inspection and cleaning was chosen with an interval of one year. This is a part of the annual control.

Similar the Trolley wheels with FM: Deformed, FC: Bearing failure was given the same selective TD PM task and interval, as it is a part of the annual control, though. This was a category B failure mode.

The motor for the trolley drive with FM: Motor bearing defective and FC: Insufficient lubrication was given the same selective TD PM task as the other motor bearing failure modes: Lubrication with grease gun every 4 years. Similar for the trolley drive motor with FM: Motor cage or rotor defective, the same selective TD PM task as for the other motor cage or defective rotor failure modes: Inspect and clean every 3 years. The FM: Brake not releasing with FC: Worn brake had the same similarity and a part of the annual control, the selective TD PM task of inspection and cleaning every year was given.

The gearbox for the travel drive were identified with FM: Gearbox not rotating, FC: Broken gears. It was stated in the user manual to change the oil every 4 years, thus the selective TD PM task of changing the oil every 4 years was chosen.

The drive pinion with FM: Drive pinion not rotating, FC: Broken theets were like the drive

pinions installed in the other systems and were stated in the user manual to be lubricated once a year. The drive pinion was given the selective TD PM task of lubrication every year.

### Sanity check

Only one functional failure was put on the RTF list and checked in the sanity check. This was the bumper. The bumper passed through the sanity check and got a continued RTF recommendation.

### Task comparison

Comparing the RCM scheduled task against the current PM program revealed some differences. Some of the components could not be identified to be covered by the current PM program, though this did not mean that these components are not a subject to maintenance, just that the descriptions available did not cover maintenance to these components. The identified PM tasks were described with their respective WS covering this task. The intervals given in the current PM program varies some from the intervals chosen in the RCM tasks. The tasks comparisons are given in the following tables.

**Table 6.7:** Task comparison 07015 bridge system.

TAG	Component Description	FM#	Failure Mode	RCM Selective dec.	Est Freq.	Current Task Description	Freq.
	BUMPER	2.1	Brittle	RTF			
	CABLE TRAY	3.1	Bent	1. Check for wear and tear or deformation - TD	1Y	WS-19OVER30.M	6M
BD/EKOM/27 23859	HEATER ELEMENT MOTOR 30 07017	4.1	Shorted	1. Inspect for external damage. - TD 2. Open and check internally - TD	1. 3M 2. 6M	WS-30MOTO68.E	1Y
BD/EKOM/27 23860	HEATER ELEMENT MOTOR 30 07259	5.1	Shorted	1. Inspect for external damage. - TD 2. Open and check internally - TD	1. 3M 2. 6M	WS-30MOTO68.E	1Y
BD/EKOM/30 07017	MOTOR TRAVEL E. CRANE OVERHEAD. 19 07015	6.1	Motor bearing defective	1. Lubricate with grease gun. - TD	4Y		
BD/EKOM/30 07017	MOTOR TRAVEL E. CRANE OVERHEAD. 19 07015	6.2	Motor cage or rotor defective	1. Inspect and clean - TD	3Y	WS-30MOTO68.E	1Y
BD/EKOM/30 07017	MOTOR TRAVEL E. CRANE OVERHEAD. 19 07015	6.3	Brake not releasing	1. Inspect and clean - TD	1Y		
BD/EKOM/30 07017	MOTOR TRAVEL E. CRANE OVERHEAD. 19 07015	7.1	Motor bearing defective	1. Lubricate with grease gun. - TD	4Y		
BD/EKOM/30 07259	MOTOR TRAVEL E. CRANE OVERHEAD. 19 07015	7.2	Motor cage or rotor defective	1. Inspect and clean - TD	3Y	WS-30MOTO68.E	1Y
BD/EKOM/30 07259	MOTOR TRAVEL E. CRANE OVERHEAD. 19 07015	7.3	Brake not releasing	1. Inspect and clean - TD	1Y		
BD/EKOM/63 07057	GEARBOX. MOTOR TRAVELLING 30 07259	8.1	Gearbox not rotating	1. Change oil - TD	4Y	WS-19OVER45.M	4Y
BD/EKOM/63 07057	GEARBOX. MOTOR TRAVELLING 30 07259	9.1	Gearbox not rotating	1. Change oil - TD	4Y	WS-19OVER45.M	4Y
	DRIVE PINION	10.1	Drive pinion not rotating	1. Lubricate with burshed or sprayed on grease - TD	1Y	WS-19OVER45.M	1Y
	DRIVE CHAIN	11.1	Drive chain broken	1. Inspect, clean and lubricate - TD	1Y		
	TRAVEL WHEELS	12.2	Structural failure	1. Inspect and clean - TD	1Y		
	TRAVEL WHEELS	12.1	Deformed	1. Inspect and clean - TD	1Y		
	TROLLEY GEAR RACK	13.1	Broken	1. Lubricate with burshed or sprayed on grease - TD	1Y	WS-19OVER45.M	4Y

**Table 6.8:** Task comparison 07015 hoist system.

TAG	Component Description	FM#	Failure Mode	RCM Selection Dec.	Est Freq.	Current Task Description	Freq.
BD/EKOM/30 07015	MOTOR HOIST. CRANE OVERHEAD 19 07015	14.4	Brake not engaging	1. Inspect and clean - TD	1Y	WS-19OVER33.M	6M
BD/EKOM/30 07015	MOTOR HOIST. CRANE OVERHEAD 19 07015	14.1	Motor bearing defective	1. Lubricate with grease gun. - TD	4Y		
BD/EKOM/30 07015	MOTOR HOIST. CRANE OVERHEAD 19 07015	14.2	Motor cage or rotor defective	1. Inspect and clean - TD	3Y	WS-30MOTO68.E	1Y
BD/EKOM/30 07015	MOTOR HOIST. CRANE OVERHEAD 19 07015	14.3	Brake not releasing	1. Inspect and clean - TD	1Y	WS-19OVER33.M	6M
	GEARBOX MOTOR HOIST INTERMITTENT	15.1	Gearbox not rotating	2. Change oil - TD	1Y	WS-19OVER45.M	4Y
	GEARBOX MOTOR HOIST MAIN	16.1	Gearbox not rotating	1. Verify oil level - TD 2. Change oil - TD	1. 1Y 2. 4Y	WS-19OVER32.M/ WS-19OVER45.M	1Y/4Y
BD/EKOM/19 02821	BLOCK DOUBLE SHEAVE WITH HOOK	17.2	Severe structural corrosion	1. Inspect and clean - TD	1Y	WS-19OVER30.M	6M
BD/EKOM/19 02821	BLOCK DOUBLE SHEAVE WITH HOOK	17.1	Corrosion in bearings	1. Lubricate with grease gun. - TD	3M	WS-19OVER59.M	3M
	UPPER BLOCK	18.2	Severe structural corrosion	1. Inspect and clean - TD	1Y	WS-19OVER30.M	6M
	UPPER BLOCK	18.1	Corrosion in bearings	1. Lubricate with grease gun. - TD	3M	WS-19OVER59.M	3M
BD/EKOM/19 02822	WIRE 18 MM MIN BRUDD 32,9 T	19.1	Broken	1. Inspect wire rope 2. Change wire rope	1. 1M 2. 6M	WS-19OVER59.M	3M
BD/EKOM/19 02822	WIRE 18 MM MIN BRUDD 32,9 T	19.3	Corroded	1. Inspect wire rope 2. Lubricate wire rope	1. 1M 2. 3M	WS-19OVER59.M	3M
	WIRE END CONNECTION OUTER	20.1	Broken	1. Inspect and clean - TD	1Y	WS-19OVER59.M	3M
	WIRE END CONNECTION	21.1	Broken	1. Inspect and clean - TD	1Y	WS-19OVER59.M	3M
	DRUM BEARINGS	49.1	Bearing failure	1. Lubricate with grease gun. - TD	1Y	WS-19OVER45.M	1Y

**Table 6.9:** Task comparison 07015 instrument system.

TAG	Component Description	FM#	Failure Mode	RCM Selective dec.	Est Freq.	Current Task Description	Freq.
BD/EKOM/43 ZE-29558	ELEMENT POSITION REFLECTOR "A" 19 07015	22.1	Missing	1. Inspect and clean - TD	3M		
BD/EKOM/43 ZE-29559	ELEMENT POSITION REFLECTOR "B" 19 07015	23.1	Missing	1. Inspect and clean - TD	3M		
BD/EKOM/43 ZS-29171	SWITCH LIMIT LASER 19 07015	24.1	False indication	1. Inspect and clean - TD	3M		
BD/EKOM/43 ZS-29172	SWITCH LIMIT LASER 19 07015	25.1	False indication	1. Inspect and clean - TD	3M		
BD/EKOM/43 TY-07017	ELEM TEMP CONVERSION FOR MOTOR 30 07017	26.1	Shorted	1. Inspect and clean - TD	1Y		
BD/EKOM/43 TY-07259	ELEM TEMPE CONVERSION FOR MOTOR 30 07259	27.1	Shorted	1. Inspect and clean - TD	1Y		
BD/EKOM/28 JE-07015	JUNCTION BOX BOX JUNCTION OVERHEAD CRANE 19 07015	28.1	Shorted	1. Inspect and clean - TD	1Y		
BD/EKOM/43 JB-03962	JB OVERRIDE SWITCH ANTI COLL. 19-07015	29.1	Shorted	1. Inspect and clean - TD	1Y		
BD/EKOM/43 JB-03971	JUNCTION BOX EX ANTI COLLISION 19-07015	30.1	Shorted	1. Inspect and clean - TD	1Y		
BD/EKOM/43 ZS-01860	SWITCH POS TRAVEL OVERH CRANE 19 07015	31.1	False indication	1. Inspect and clean - TD	1Y	WS-19OVER30.M	6M
BD/EKOM/43 ZS-01861	SWITCH POS TRAVEL OVERH CRANE 19 07015	32.1	False indication	1. Inspect and clean - TD	1Y	WS-19OVER30.M	6M
BD/EKOM/43 ZS-01856	SW LIMIT HOOK POS OVERH CRANE 19 07015	33.1	False indication	1. Inspect and clean - TD	1Y	WS-19OVER30.M	6M
BD/EKOM/43 ZS-01856	SW LIMIT HOOK POS OVERH CRANE 19 07015	34.1	Incorrect setting	1. Verify limits	3M	WS-19OVER30.M	6M
BD/EKOM/43 ZS-01858	SWITCH POS TROLLY OVERH CRANE 19 07015	34.2	False indication	1. Inspect and clean - TD	1Y	WS-19OVER30.M	6M
BD/EKOM/43 ZS-01859	SWITCH POS TROLLY OVERH CRANE 19 07015	35.1	False indication	1. Inspect and clean - TD	1Y	WS-19OVER30.M	6M
BD/EKOM/28 07015	OVERLOAD SWITCH HOIST	36.1	False indication	1. Inspect and clean - TD	1Y	WS-19OVER30.M	6M
BD/EKOM/28 07016	OVERLOAD SWITCH HOIST	37.1	False indication	1. Inspect and clean - TD	1Y	WS-19OVER33.M	6M
BD/EKOM/28 08294	OVERLOAD SWITCH HOIST	37.2	Incorrect setting	1. Verify limits - TD	9M	WS-19OVER33.M	6M
BD/EKOM/28 LCP-07015	SWITCH MAIN FOR OVERHEAD CRANE 19 07015	38.1	Shorted	1. Inspect and clean - TD	1Y		
BD/EKOM/28 07016	SWITCH PUSH BUTTON STATION FOR 19 07015	39.1	Shorted	1. Inspect and clean - TD	1Y	WS-30MOTO68.E	1Y
BD/EKOM/28 08294	SWITCH EMERG STOP CRANE 19 07015	40.1	Shorted	1. Inspect and clean - TD	1Y		
BD/EKOM/28 LCP-07015	PANEL CONTROL. OVERHEAD CRANE 19 07015	41.1	Shorted	1. Inspect and clean - TD	1Y		

**Table 6.10:** Task comparison 07015 runway system.

TAG	Component Description	FM#	Failure Mode	RCM Selective dec.	Est Freq.	Current Task Description	Freq.
	BRIDGE GEAR RACK	43.1	Broken	1. Lubricate with burshed or sprayed on grease - TD	1Y	WS-19OVER30.M	6M
	RUNWAY BEAMS	44.1	Severe structural corrosion	1. Inspect and clean - TD	1Y	WS-19OVER30.M	6M

**Table 6.11:** Task comparison 07015 trolley system.

TAG	Component Description	FM#	Failure Mode	RCM Selective dec.	Est Freq.	Current Task Description	Freq.
BD/EKOM/30 07016	TROLLEY TRAVEL WHEELS	45.1	Severe structural corrosion	1. Inspect and clean - TD	1Y	WS-19OVER30.M	6M
	TROLLEY TRAVEL WHEELS	45.1	Deformed	1. Inspect and clean - TD	1Y	WS-19OVER30.M	6M
BD/EKOM/30 07016	MOTOR TROLLEY. CRANE OVERHEAD 19 07015	46.1	Motor bearing defective	1. Lubricate with grease gun. - TD	4Y		
BD/EKOM/30 07016	MOTOR TROLLEY. CRANE OVERHEAD 19 07015	46.2	Motor cage or rotor defective	1. Inspect and clean - TD	3Y	WS-30MOTO68.E	1Y
BD/EKOM/30 07016	MOTOR TROLLEY. CRANE OVERHEAD 19 07015	46.3	Brake not releasing	1. Inspect and clean - TD	1Y		
BD/EKOM/30 07016	GEARBOX TROLLEY MOTOR	47.1	Gearbox not rotating	1. Change oil - TD	4Y		
	PINION TROLLEY DRIVE	48.1	Drive pinion not rotating	1. Lubricate with burshed or sprayed on grease - TD	1Y	WS-19OVER45.M	1Y
	BOOGIE WHEEL CONNECTION					WS-19OVER45.M	1Y

### 6.3 15 T Crane 07020

15 Tonnes Crane with TAG BD/EKOM/840/19 07020.

#### 6.3.1 System selection and information collection

In the first step of the RCM analysis. Data was collected. One will find the generic data in chapter 5. The historic data, or notification history was sorted and put into the respective system and subsystems.

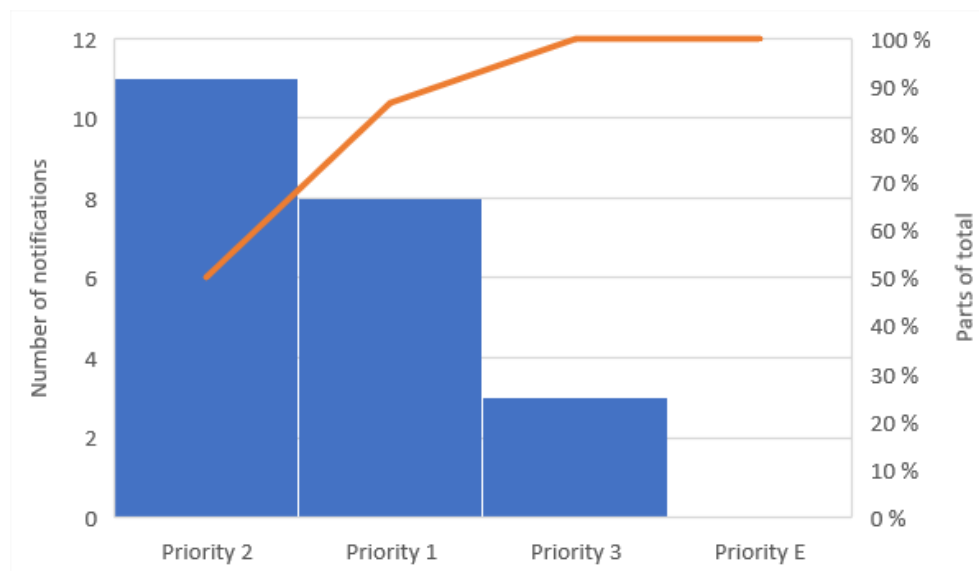

**Figure 6.17:** Notification per priority category 07020.

Figure 6.17 shows the priority of all the notifications on crane 07020 for the period of 2006 to 2017. Note 80% of the notifications were of type 2 or 1, none are of type E.

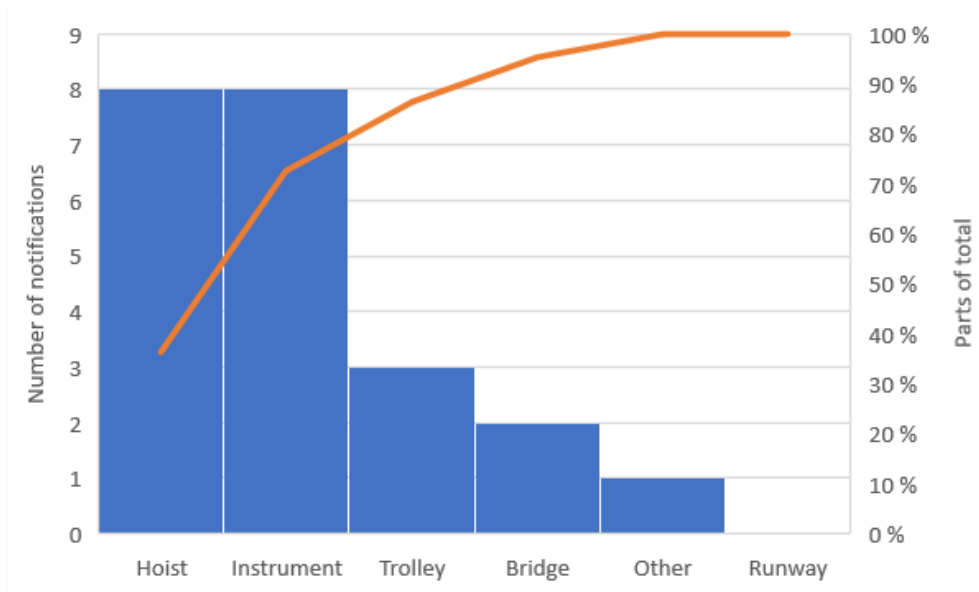

**Figure 6.18:** Pareto diagram for 07020.

On figure 6.18 the pareto diagram for crane 07020 is shown. A large quantity of, I.e. over 80% of the notifications were attributed to hoist or instrument system.

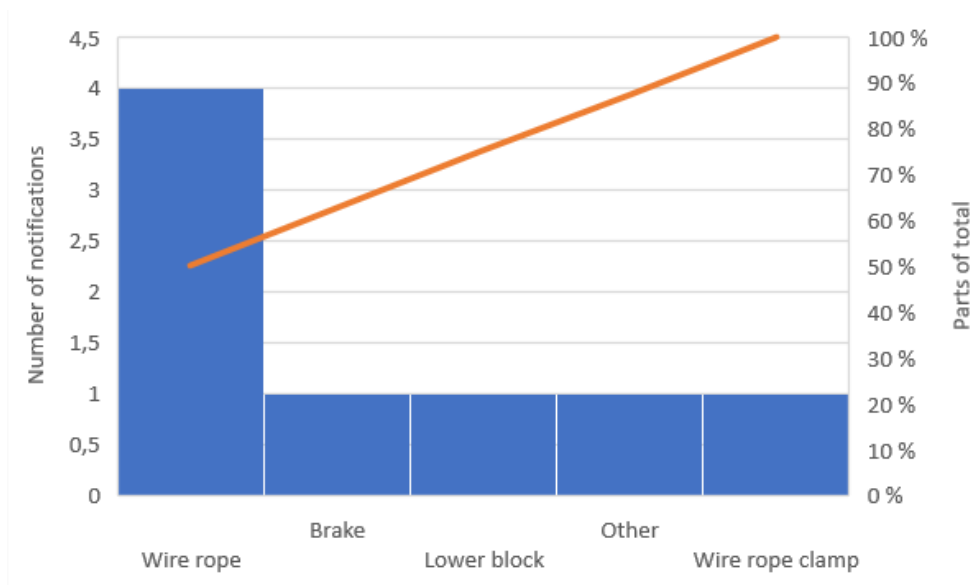

**Figure 6.19:** Pareto diagram for hoist system 07020.

The pareto diagram for hoist system, shown on figure 6.19. Shows 50% of the notifications in this system were attributed to the wire rope, and the rest one and one, notification on brake, lower block, others, and wire rope clamp.

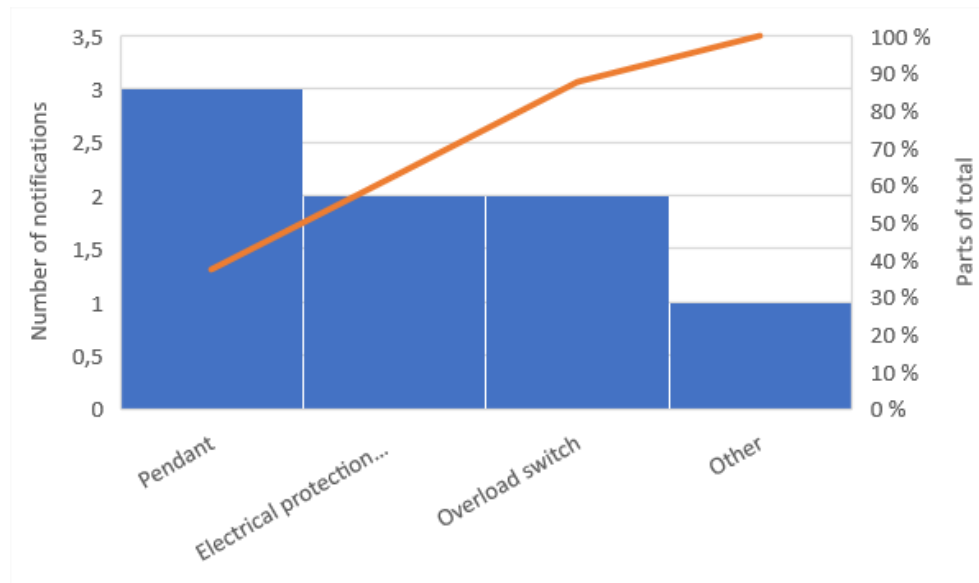

**Figure 6.20:** Pareto diagram for instrument system 07020.

Figure 6.20 is showing the pareto diagram for the instrument system. The biggest attributor to notifications were the pendant, together with the electrical protection devices and the overload switch it totals of over 80% of all the notifications to instrument system.

### 6.3.2 System boundary definition

The boundaries of the crane assembly as a system were defined at the electrical supply and structural support for runway beams in one end. The actual lifted load in the other end. Main components in the respective systems were for bridge: Girders, Bridge drive: Gearbox, Motor, etc., and cable tray. For hoist: Hoist drive, wire rope and block assembly. Instrument: Radio remote, limit switches and overload switch. For runway: Runway beams and runway bridge travel rack. At last, the trolley had the following main components: Trolley drive, pinions, and wheels.

### 6.3.3 System description and functional block diagram

#### System description

The Electrical Overhead Travelling Cranes are of underslung monobox special design for Ekofisk platform, 2/4M module W30.

Main Girder is made as box of plates and the end trucks are made of channel profiles and steel plates.

Cranes are made for Zone 1 hazardous area. All el. Equipment are designed for Zone 1.

The cranes are for offshore installations with ambient temperature -20 deg C.

Following main data:

- Capacity: 15 T.



- Span: 6000 mm.
- Height of lift: 10 m.
- Hoisting speed: 3,6 / 0,9 m/min (two speed).
- Trolley speed: 6 m/min.
- Crane speed: 6 m/min.
- Power supply: 690 V/ 60 Hz.
- Heel: Max. 1°.

Runway beams: HE260M.

Further according to GA dwg. No.: E900-11915-M-00007-001.

The crane bridge is running on runway beams under flanges with sixteen (16) of single flange travel wheels. Crane bridge is equipped with rack and pinion drive and driven by electrical explosion proof single speed motors with fail safe brakes through gear and pinion. Limit switches are installed on the crane in addition to heavy duty bumpers in each end of the runway beams.

Crane is equipped with electrical wire hoist with four wire falls. The hoist motor is two speed of explosion proof design with fail safe brake. Overload switch and limit switches for top and bottom position are included. Wire drum grooved, and hoist is equipped with non-spark spooling device to ensure correct wire spooling on the drum. Wire rope is galvanized and of non-rotating type.

The trolley is running on 4 wheels. The trolley is provided with rack and pinion drive. Drive is by electrical explosion proof single speed motor with fail safe bake through gear and cross shaft. Limit switches are installed on the crane in addition to heavy duty bumpers in each end of the crane.

### **Functional block diagram**

A functional block diagram (please see figure 6.4) was made to illustrate the interaction between the different systems in the crane. Giving the boundaries with power, support, and lifted load, as well as internal power distribution, energy, and signals.

### **IN/OUT Interfaces**

The IN/OUT interface list gave a description over the type of interface, e.g. power, energy, structural, the bounding system, interface location and reference drawing. As in the boundary definition it was defined that the boundary was given from electrical supply and runway supports to the actual handled load attached in the crane hook.

### **System work breakdown structure**

The SWBS was based on the TAG-lists retrieved from SAP and found in appendix C. It contained the components registered in SAP today with some manual addition taken from both the historic data, the drawings in the crane documentation and previous analysis'. The SWBS was grouped in the following order: TAG NO, Description, System, Subsystem, Type (Instrument only), Quantity and reference. 7 tags had been given a protection type and 4 were given a control type.

### **Equipment history**

The equipment history is a file compiled of the historic notification data from SAP. Usually the recommendation is to use history data from the last 2 or 3 years, in this case all the historic data accumulated on this machine were put into the equipment history, this were done because there was not a large quantity of data available. At least not for the last 2 or 3 years. The data were grouped on date, TAG, description, system, subsystem, failure mode and failure cause. Due to insufficient plotting of the data a large quantity of events lacked a good description of the actual cause of failure, and a large quantity of the data lacked a connection to the given tag. Some assumptions had to be done to group the data into the right tag and system as well as the cause of failure.

#### **6.3.4 System functions and functional failures**

Based on the SWBS a system functions list was made, listing each component functions. These functions were assigned one, two or several possible functional failures.

E.g. The function of the bridge drive motors is to move the bridge. Possible functional failures were that the bridge is not moving.

The functions were based upon the OUT interface of handling the load attached in the crane hook. This is the main objective to the crane. Either this handling is up, down, north, south, east, or west. Functions were listed with the support of functional description, drawings, schematics, component manufactures documentation and the analysts understanding of this system.

#### **6.3.5 Failure mode and effects analysis**

Prior to the FMEA an equipment-functional failure matrix was made based on the functional failures identified in step 4. This equipment-functional failure matrix had initially 75 failure modes which in terms would lead to 17 different unique functional failures.

During the FMEA it was observed that several of the failure modes could lead to several functional failures. The number of failure modes which leads to unique functional failures was lowered to 42.

#### **6.3.6 Logic Tree Analysis**

Based upon the FMEA, the LTA was performed. 38 Failure modes were given a letter A, for safety related functional failure. A large portion of this failure modes were attributed to instruments which were given a control or safety designation in the SWBS. Other failure modes were attributed to structure safety.

23 failure modes were given a designation letter B, meaning that these failure modes would give significant outage but pose small safety consequences. In this section one will identify the crane drive in the bridge, trolley drive in the trolley and junction boxes. Designation letter B is given to the equipment if there was significant outage; significant outage was defined as a momentary stop in the EOT crane when a well intervention campaign is being performed, given all the equipment which is mobilized for well intervention and the frequency the EOT cranes are used.

### 6.3.7 Task selection

The task selection step was performed in three sub-steps: Task selection process, sanity check and task comparison.

#### Task selection

The initial task selection process was performed in the order of the prioritized PM tasks according to the LTA step. Due to the former established systems on bridge, hoist, instrument, other, runway and trolley the process and results will be listed in the same manner. Several of the tasks were given the effective info comment of “A Part of annual control”, this is stated in the user manual (Dreggen Crane AS 2004a).

Where at least 3 data points in the equipment history were identified contributing to the same failure mode, reliability calculations by Weibull analysis were performed. For purpose of reliability calculations, a reliability rate of at least 80% was chosen. This rate was chosen as there were no definite requirements identified in applicable rules, regulations, and standards.

#### *Bridge*

For bridge-system the only grade A failure mode was related to the travel wheels. Structural failure in the travel wheels caused by massive degradation to structure. Task candidate was TD task of inspection and cleaning with estimate frequency of 1 year. This task is a part of annual control.

Other task part of annual control, selected TD task of inspection and cleaning, with the estimated frequency or 1 year were:

- Cable loop – FM: Broken, FC: Snagging in structures.
- Motor Travel – FM: Brake not releasing, FC: Worn Brake.
- Travel wheels – FM: Deformed, FC: Bearing failure.

The Motor for travel was given a TD selective task of lubrication with grease gun every 4 year to prevent the FM: Motor bearing defective.

To prevent the FM: Motor cage or rotor defective, with the FC: Age. A TD selective task of inspection and cleaning was scheduled every 3 years. The user manual for the motors states a reference to IEC 60079-17 which gives 3 years as the largest interval to check Ex d – Explosion-proof enclosures (Standard Norge 2016).

The gearboxes for travel were identified to have a FM of gearbox not rotating and a failure cause of broken gears. The selective PM task was a TD task for changing oil every 4 years, given by the user manual (Dreggen Crane AS 2004a).

Similar the drive pinion, drive chain and trolley gear rack were identified to have the FM of broken, by either FC: Missing or broken theets or aberration. The selective PM task was a TD task for lubrication every 1 year.

#### *Hoist*

Hoist system had 13 failure modes given a category A from the LTA.

Several of these FM were given TD tasks which stated in the user manual to be a part of the annual control, and thus, had a given interval of 1 year:

- Motor hoist, FM: Brake not engaging, FC: Wear and tear.
- Motor hoist, FM: Brake not engaging, FC: Worn brake.
- Block double, FM: Severe structural corrosion, FC: Lack of sufficient cross section in axle.
- Upper block, FM: Severe structural corrosion, FC: Lack of sufficient cross section in axle.
- Wire end connection outer, FM: Broken, FC: Broken because of misuse or severe deterioration.
- Wire end connection inner, FM: Broken, FC: Broken because of misuse or severe deterioration.

The drive motor had an identified FM: Motor bearing defective, FC: Insufficient lubrication. The selective TD task of lubrication with grease gun every 4 years was chosen.

The drive motor had an identified FM: Motor cage or rotor defective, FC: Age. This was like the bridge travel motors. An inspection of explosion proof motors must be done at least every 3 years. Thus, the selective TD task was inspection and clean every 3 years.

Gearbox had a FM of gearbox not rotating, FC was broken gears. A selective TD task was to check oil level every 1 year and change oil every 4 years.

Both the upper block and the lower block had an identified FM: Corrosion in bearings, FC: Water penetration in bearings. The selective TD task of lubrication with grease gun every 3 months were chosen to prevent water penetration.

Wire had several FM: Broken, Missing and Corroded, with applicable FC: Broken because of severe misuse, deterioration, or Lack of lubrication. For the first FM selective TD tasks were inspection of the wire rope every 1 month and changing the wire rope every year. To achieve reliability rate of 80,42% and a MTBF of 1360 days the wire rope had to be changed 150 days.

The Weibull plot in figure 6.21 is showing on the x-axis, the natural logarithmic of the cycles or in this case days between occurring failure modes. On the y-axis it is the natural logarithmic of an estimate of the portion of components which has failed by rank. Each blue dot is a data point from the equipment history and the line is a trend line based on the data points.

The FM of lack of lubrication was given a selective TD task for inspection of wire rope every 1 month and lubrication every 3 month.

For the hoist system 1 FM was identified and classified as category B in the LTA.

Drum bearings were given the selective TD PM task of lubrication with grease every year.

#### *Instrument*

The Instrument system had 20 identified FM which were given a designation A in the LTA.

Instrument and junction box (JB) OEMs had been observed to writes little or nothing in the user instructions about maintenance, and the little which was written was observed to state a

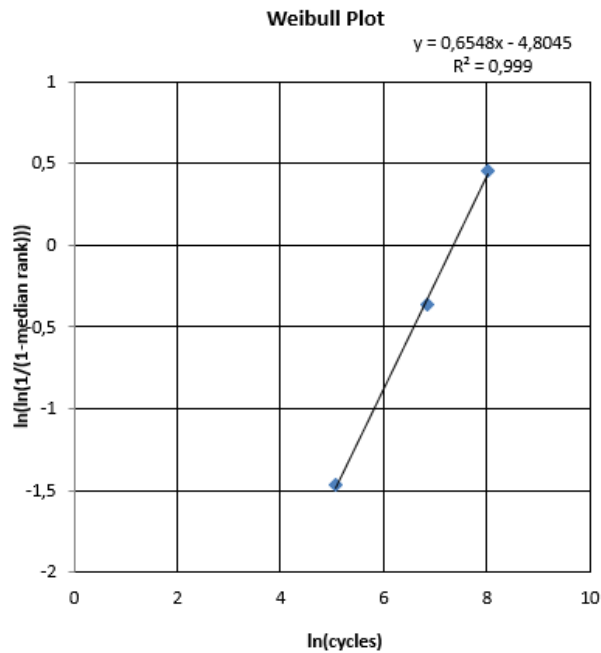

**Figure 6.21:** Weibull plot for wire rope 07020.

reference to IEC 60079-17, which in terms were giving an instruction to inspect at least every 3 years. Using historic data and discussions from meetings it water penetration was a larger issue than to be inspected every 3 years. Thus, the selective task for several of the instruments would be a TD PM task of inspection and cleaning every 1 year. Applicable to the following components, FM, and FC:

- Switch pos. crane travel – FM: False indication, FC: Age.
- Switch pos. crane travel – FM: Broken, FC: Moisture in the electronics.
- Switch pos. top hoist – FM: False indication, FC: Age.
- Switch pos. bot hoist – FM: False indication, FC: Age.
- Switch pos. trolley travel – FM: False indication, FC: Age.
- Switch pos. trolley travel – FM: Broken, FC: Moisture.
- Overload switch – FM: False indication, FC: Moisture in the electronics.
- Switch emergency stop – FM: Shorted, FC: Moisture.
- Panel control, or radio remote – FM: Shorted, FC: Moisture.

The limit switch for hoist with the FM of incorrect setting, unknown FC are given a TD PM task of verifying limits every 3 months.

The overload switch for the hoist with the failure mode of incorrect setting would have a reliability of over 90% if the limits were checked using the interval of at least 3 years. MTBF was 1498 days. A TD PM task of verification of the limits were scheduled for every year.

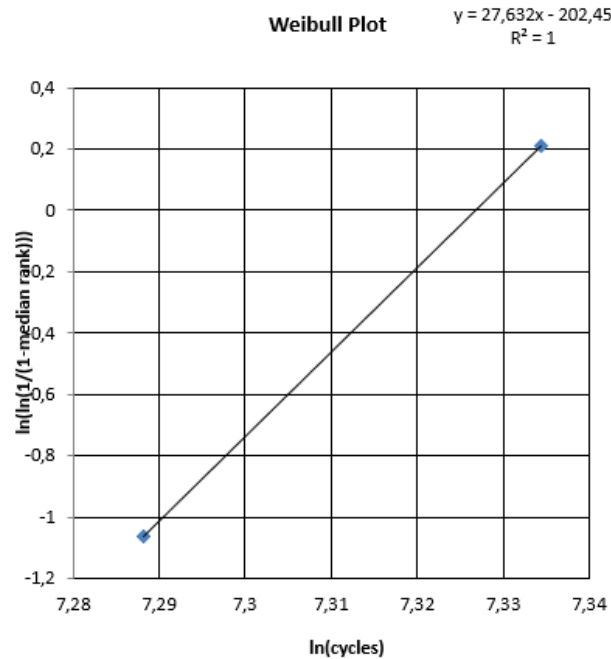

**Figure 6.22:** Weibull plot for overload switch 07020.

4 failure modes for instrument were categorized B in the LTA.

The failure modes for instruments with category B were like the instruments and junction boxes stated under the category A failure modes and would give a selective TD PM task of inspection and cleaning once a year:

- Junction box – FM: Shorted, FC: Moisture.
- Box Junction overhead – FM: Shorted, FC: Moisture.
- Main switch – FM: Shorted, FC: Moisture.
- Push button station – FM: Shorted, FC: Moisture.

#### *Other*

In the system of other the only item was the pad eye for test, FM: overstress and FC: Tear out due to loss of cross section. Given a selective TD PM task checking for wear and tear every year, though this is a part of annual control.

#### *Runway*

In the system of Runway, the Runway beams were listed with a FM: Severe structural corrosion and FC: Lack of sufficient cross section in structural supports. This was a category A failure mode. The selective TD PM task was inspection and cleaning every year, though this is a part of annual control.

The bridge gear rack was listed with a FM: Broken, FC: Missing rack theets. This failure mode was given a selective TD PM task of lubrication every year, such as stated in the user instructions. This was category B.

### *Trolley*

The trolley system was identified with 2 category A failure modes and 5 category B. Trolley wheels with FM: Severe structural corrosion and FC: Loss of sufficient cross section in axle and FM: Deformed with FC: Bearing failure were the category A failure modes. A selective TD PM task of inspection and cleaning was chosen with an interval of one year. This is a part of the annual control.

The motor for the trolley drive with FM: Motor bearing defective and FC: Insufficient lubrication was given the same selective TD PM task as the other motor bearing failure modes: Lubrication with grease gun every 4 years. Similar for the trolley drive motor with FM: Motor cage or rotor defective, the same selective TD PM task as for the other motor cage or defective rotor failure modes: Inspect and clean every 3 years. The FM: Brake not releasing with FC: Worn brake had the same similarity and a part of the annual control, the selective TD PM task of inspection and cleaning every year was given.

The gearbox for the travel drive were identified with FM: Gearbox not rotating, FC: Broken gears. It was stated in the user manual to change the oil every 4 years, thus the selective TD PM task of changing the oil every 4 years was chosen.

The drive pinion with FM: Drive pinion not rotating, FC: Broken theets were like drive pinions installed in the other systems and were stated in the user manual to be lubricated once a year. The drive pinion was given the selective TD PM task of lubrication every year.

### **Sanity check**

Only one functional failure was put on the RTF list and checked in the sanity check. This was the bumper. The bumper passed through the sanity check and got a continued RTF recommendation.

### **Task comparison**

Comparing the RCM scheduled task against the current PM program revealed some differences. Some of the components could not be identified to be covered by the current PM program, though this did not mean that these components are not a subject to maintenance, just that the descriptions available did not cover maintenance to these components. The identified PM tasks were described with their respective WS covering this task. The intervals given in the current PM program varies some from the intervals chosen in the RCM tasks. The tasks comparisons are given in the following tables.



**Table 6.12:** Task comparison 07020 bridge system.

TAG	Component Description	FM#	Failure Mode	RCM Selective dec.	Est Freq.	Current Task	Freq.
	BUMPER	2.1	Brittle	RTF			
	CABLE LOOP	3.1	Broken	1. Check for wear and tear or deformation - TD	1Y	WS-19OVER30.M	6M
30 07022	MOTOR TRAVEL CRANE OVERHEAD.	4.1	Motor bearing defective	1. Lubricate with grease gun. - TD	4Y		
30 07022	MOTOR TRAVEL CRANE OVERHEAD.	4.2	Motor cage or rotor defective	1. Inspect and clean - TD	3Y	WS-30MOTO68.E	1Y
30 07022	MOTOR TRAVEL CRANE OVERHEAD.	4.3	Brake not releasing	1. Inspect and clean - TD	1Y		
30 07023	MOTOR TRAVEL CRANE OVERHEAD.	5.1	Motor bearing defective	1. Lubricate with grease gun. - TD	4Y		
30 07023	MOTOR TRAVEL CRANE OVERHEAD.	5.2	Motor cage or rotor defective	1. Inspect and clean - TD	3Y	WS-30MOTO68.E	1Y
30 07023	MOTOR TRAVEL CRANE OVERHEAD.	5.3	Brake not releasing	1. Inspect and clean - TD	1Y		
	GEARBOX.	6.1	Gearbox not rotating	1. Change oil - TD	4Y	WS-19OVER46.M	4Y
	MOTOR TRAVELLING GEARBOX.	7.1	Gearbox not rotating	1. Change oil - TD	4Y	WS-19OVER46.M	4Y
	MOTOR TRAVELLING DRIVE PINION	8.1	Drive pinion not rotating	1. Lubricate with burshed or sprayed on grease - TD	1Y	WS-19OVER46.M	1Y
	TRAVEL WHEELS	9.2	Structural failure	1. Inspect and clean - TD	1Y	WS-19OVER30.M	6M
	TRAVEL WHEELS	9.1	Deformed	1. Inspect and clean - TD	1Y	WS-19OVER30.M	6M
	TROLLEY GEAR RACK	10.1	Broken	1. Lubricate with burshed or sprayed on grease - TD	1Y	WS-19OVER46.M	1Y

**Table 6.13:** Task comparison 07020 hoist system.

TAG	Component Description	FM#	Failure Mode	RCM Selective dec.	Est Freq.	Current Task	Freq.
30 07020	MOTOR HOIST. CRANE OVERHEAD	11.4	Brake not engaging	1. Inspect and clean - TD	1Y		
30 07020	MOTOR HOIST. CRANE OVERHEAD	11.1	Motor bearing defective	1. Lubricate with grease gun. - TD	4Y		
30 07020	MOTOR HOIST. CRANE OVERHEAD	11.2	Motor cage or rotor defective	1. Inspect and clean - TD	3Y	WS-30MOTO68.E	1Y
30 07020	MOTOR HOIST. CRANE OVERHEAD	11.3	Brake not releasing	1. Inspect and clean - TD	1Y	WS-19OVER33.M	6M
	GEARBOX	12.1	Gearbox not rotating	1. Verify oil level - TD 2. Change oil - TD	1. 1Y 2. 4Y	WS-19OVER46.M	4Y
	MOTOR HOIST DRUM BEARINGS	13.1	Bearing failure	1. Lubricate with grease gun. - TD	1Y		
19 02817	BLOCK DOUBLE SHEAVE WITH HOOK	14.2	Severe structural corrosion	1. Inspect and clean - TD	1Y	WS-19OVER30.M	6M
19 02817	BLOCK DOUBLE SHEAVE WITH HOOK	14.1	Corrosion in bearings	1. Lubricate with grease gun. - TD	3M	WS-19OVER59.M	3M
	UPPER BLOCK	15.2	Severe structural corrosion	1. Inspect and clean - TD	1Y	WS-19OVER30.M	6M
	UPPER BLOCK	15.1	Corrosion in bearings	1. Lubricate with grease gun. - TD	3M	WS-19OVER59.M	3M
19 02818	WIRE 14 MM MIN BRUDD 20T	16.1	Broken	1. Inspect wire rope 2. Change wire rope	1. 1M 2. 1Y	WS-19OVER59.M	3M
19 02818	WIRE 14 MM MIN BRUDD 20T	16.2	Corroded	1. Inspect wire rope 2. Lubricate wire rope	1. 1M 2. 3M	WS-19OVER59.M	3M
	WIRE END CONNECTION OUTER	17.1	Broken	1. Inspect and clean - TD	1Y	WS-19OVER59.M	3M
	WIRE END CONNECTION	18.1	Severe structural corrosion	1. Inspect and clean - TD	1Y	WS-19OVER30.M	6M

**Table 6.14:** Task comparison 07020 instrument system.

TAG	Component Description	FM#	Failure Mode	RCM Selective dec.	Est Freq.	Current Task	Freq.
28 JE-07020	BOX JUNCTION OVERHEAD CRANE 19 07020	19.1	Shorted	1. Inspect and clean - TD	1Y	WS-19OVER30.M	6M
28 JE-07021	BOX JUNCTION OVERHEAD CRANE 19 07020	20.1	Shorted	1. Inspect and clean - TD	1Y	WS-19OVER30.M	6M
ZS-01866	SWITCH POS TRAVEL OVERH CRANE 19 07020	21.1	False indication	1. Inspect and clean - TD	1Y	WS-19OVER30.M	6M
ZS-01866	SWITCH POS TRAVEL OVERH CRANE 19 07020	21.1	False indication	1. Inspect and clean - TD	1Y	WS-19OVER30.M	6M
ZS-01866	SWITCH POS TRAVEL OVERH CRANE 19 07020	21.2	Broken	1. Inspect and clean - TD	1Y	WS-19OVER30.M	6M
ZS-01867	SWITCH POS TRAVEL OVERH CRANE 19 07020	22.1	False indication	1. Inspect and clean - TD	1Y	WS-19OVER30.M	6M
ZS-01867	SWITCH POS TRAVEL OVERH CRANE 19 07020	22.1	False indication	1. Inspect and clean - TD	1Y	WS-19OVER30.M	6M
ZS-01867	SWITCH POS TRAVEL OVERH CRANE 19 07020	22.2	Broken	1. Inspect and clean - TD	1Y	WS-19OVER30.M	6M
ZS-01862	SW LIMIT POS HOOK TOP OVERH CRANE 19 07020	23.1	False indication	1. Inspect and clean - TD	1Y	WS-19OVER30.M	6M
ZS-01862	SW LIMIT POS HOOK TOP OVERH CRANE 19 07020	23.2	Incorrect setting	1. Verify limits - TD	3M	WS-19OVER30.M	6M
ZS-01863	SW LIMIT POS HOOK BOTT OVERH CRANE 19 07020	24.1	False indication	1. Inspect and clean - TD	1Y	WS-19OVER30.M	6M
ZS-01863	SW LIMIT POS HOOK BOTT OVERH CRANE 19 07020	24.2	Incorrect setting	1. Verify limits - TD	3M	WS-19OVER30.M	6M
ZS-01864	SWITCH POS TROLLY OVERH CRANE 19 07020	25.1	False indication	1. Inspect and clean - TD	1Y	WS-19OVER30.M	6M
ZS-01865	SWITCH POS TROLLY OVERH CRANE 19 07020	26.1	False indication	1. Inspect and clean - TD	1Y	WS-19OVER30.M	6M
ZS-01865	SWITCH POS TROLLY OVERH CRANE 19 07020	26.2	Broken	1. Inspect and clean - TD	1Y	WS-19OVER30.M	6M
	OVERLOAD SWITCH HOIST	27.1	False indication	1. Inspect and clean - TD	1Y	WS-19OVER33.M	6M
	OVERLOAD SWITCH HOIST	27.2	Incorrect setting	1. Verify limits	1Y	WS-19OVER33.M	6M
28 07020	SWITCH MAIN FOR OVERHEAD CRANE 19 07020	28.1	Shorted	1. Inspect and clean - TD	1Y		
28 07021	SWITCH PUSH BUTTON STATION FOR 19 07020	29.1	Shorted	1. Inspect and clean - TD	1Y		
28 08295	SWITCH EMERG STOP CRANE 19 07020	30.1	Shorted	1. Inspect and clean - TD	1Y		
LCP-07020	PANEL CONTROL OVERHEAD CRANE 19 07020	31.1	Shorted	1. Inspect and clean - TD	1Y	WS-19OVER30.M	6M

**Table 6.15:** Task comparison 07020 other system.

TAG	Component Description	FM#	Failure Mode	RCM Selective dec.	Est Freq.	Current Task	Freq.
19 07559	PADEYE TEST SWL 25T (FOR OT CRANE )	32.1	Overstress	1. Check for wear and tear or deformation - TD	1Y		

**Table 6.16:** Task comparison 07020 runway system.

TAG	Component Description	FM#	Failure Mode	RCM Selective dec.	Est Freq.	Current Task	Freq.
	BRIDGE GEAR RACK	33.1	Broken	1. Lubricate with burshed or sprayed on grease - TD	1Y	WS-19OVER30.M	6M
	RUNWAY BEAMS	34.1	Severe structural corrosion	1. Inspect and clean - TD	1Y	WS-19OVER30.M	6M

**Table 6.17:** Task comparison 07020 trolley system.

TAG	Component Description	FM#	Failure Mode	RCM Selective dec.	Est Freq.	Current Task	Freq.
	TROLLEY TRAVEL WHEELS	35.1	Severe structural corrosion	1. Inspect and clean - TD	1Y	WS-19OVER30.M	6M
	TROLLEY TRAVEL WHEELS	35.1	Deformed	1. Inspect and clean - TD	1Y	WS-19OVER30.M	6M
30 07021	MOTOR TROLLEY. CRANE OVERHEAD 19 07020	36.1	Motor bearing defective	1. Lubricate with grease gun. - TD	4Y		
30 07021	MOTOR TROLLEY. CRANE OVERHEAD 19 07020	36.2	Motor cage or rotor defective	1. Inspect and clean - TD	3Y	WS-30MOTO68.E	1Y
30 07021	MOTOR TROLLEY. CRANE OVERHEAD 19 07020	36.3	Brake not releasing	1. Inspect and clean - TD	1Y		
	GEARBOX TROLLEY MOTOR	37.1	Gearbox not rotating	1. Change oil - TD	4Y	WS-19OVER46.M	4Y
	PINION TROLLEY DRIVE	38.1	Drive pinion not rotating	1. Lubricate with burshed or sprayed on grease - TD	1Y	WS-19OVER46.M	1Y

## 6.4 15 T Crane 07025

15 Tonnes crane with TAG BD/EKOM/840/19 07025. This crane is identical to the one in section 6.3. Thus, this section will hold large similarities to section 6.3.

### 6.4.1 System selection and information collection

In the first step of the RCM analysis. Data was collected. One will find the generic data in chapter 5. The historic data, or notification history was sorted and put into the respective system and subsystems.

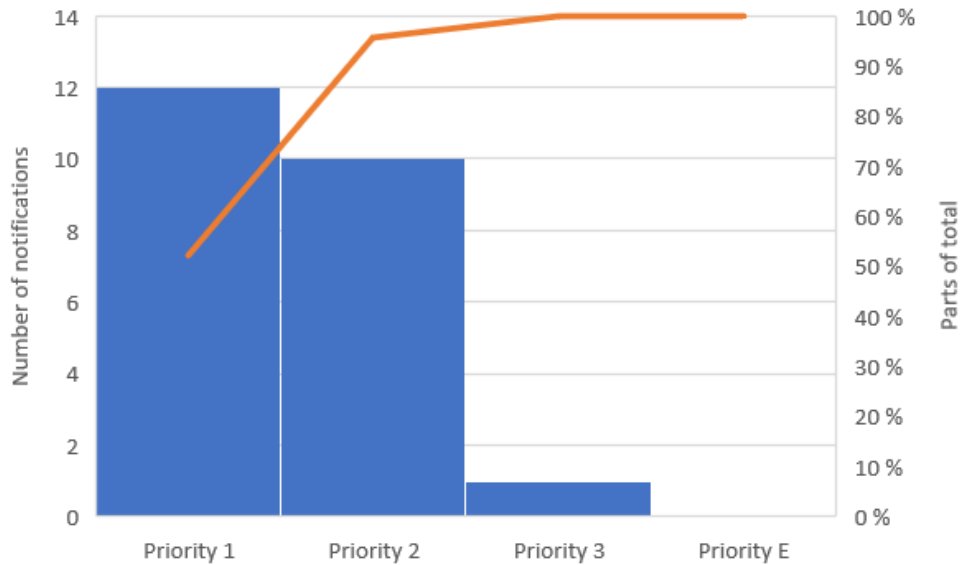

**Figure 6.23:** Notification per priority category 07025.

Figure 6.23 shows the priority of all the notifications on crane 07025 for the period of 2006 to 2017. Note 80% of the notifications was of type 1 or 2, none were of type E.

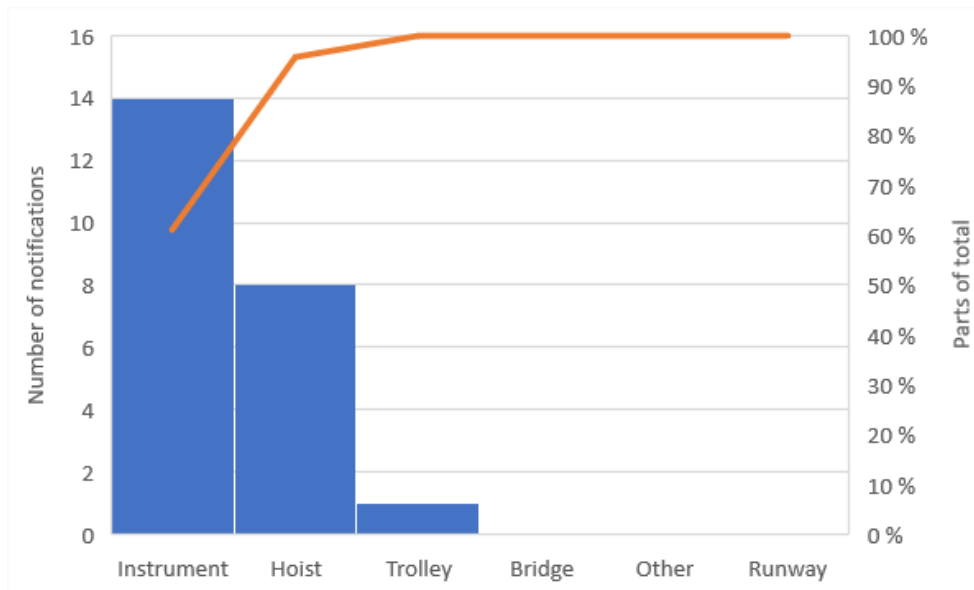

**Figure 6.24:** Pareto diagram for 07025.

On figure 6.24 the pareto diagram for crane 07025 is shown. A large quantity of, I.e. over 80% of the notifications were attributed to instrument or hoist system.

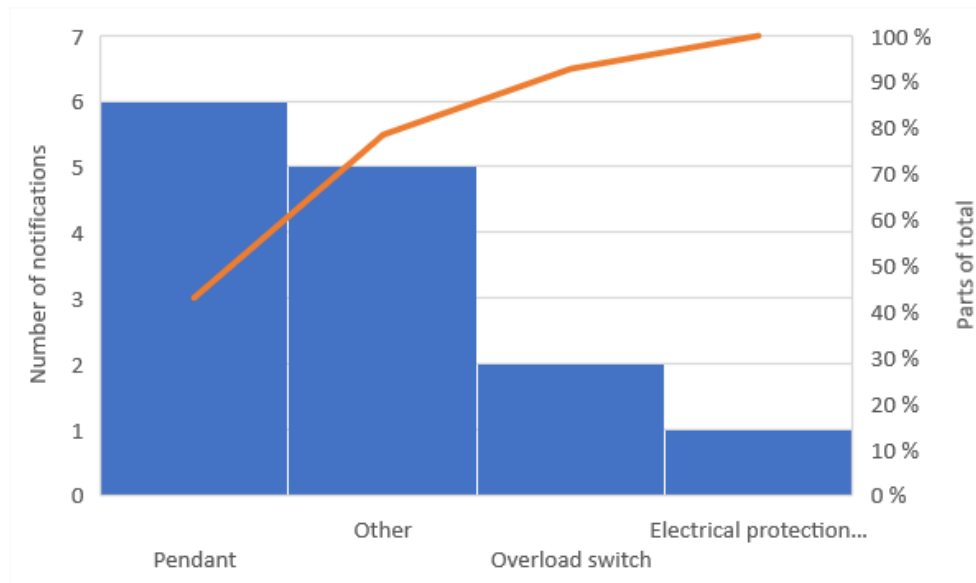

**Figure 6.25:** Pareto diagram for instrument system 07025.

Figure 6.25 is showing the pareto diagram for the instrument system. The biggest attributor to notifications were the pendant, together with other and the overload switch it totals of over 80% of all the notifications in instrument system.

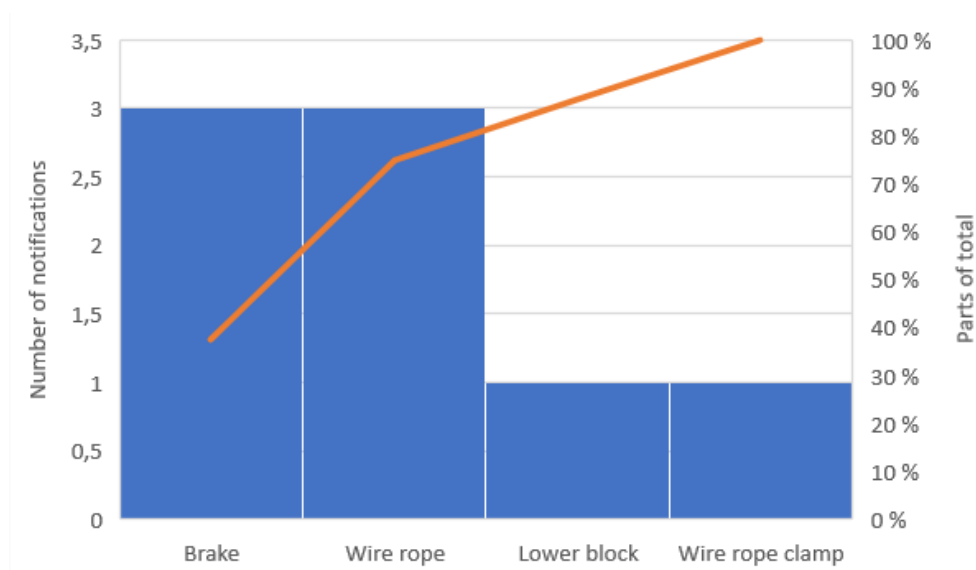

**Figure 6.26:** Pareto diagram for hoist system 07025.

The pareto diagram for hoist system, shown on figure 6.26. The diagram displays over 80% of the notifications in this system were attributed to the brake and wire rope.

#### 6.4.2 System boundary definition

The boundaries of the crane assembly as a system were defined at the electrical supply and structural support for runway beams in one end. The actual lifted load in the other end. Main components in the respective systems were for bridge: Girders, Bridge drive: Gearbox, Motor,

etc., and cable tray. For hoist: Hoist drive, wire rope and block assembly. Instrument: Radio remote, limit switches and overload switch. For runway: Runway beams and runway bridge travel rack. At last, the trolley had the following main components: Trolley drive, pinions, and wheels.

### 6.4.3 System description and functional block diagram

#### System description

The Electrical Overhead Travelling Cranes are of underslung monobox special design for Ekofisk platform, 2/4M module W30.

Main Girder is made as box of plates and the end trucks are made of channel profiles and steel plates.

Cranes are made for Zone 1 hazardous area. All el. Equipment are designed for Zone 1.

The cranes are for offshore installations with ambient temperature -20 deg C.

Following main data:

- Capacity: 15 T.
- Span: 6000 mm.
- Height of lift: 10 m.
- Hoisting speed: 3,6 / 0,9 m/min (two speed).
- Trolley speed: 6 m/min.
- Crane speed: 6 m/min.
- Power supply: 690 V / 60 Hz.
- Heel: Max. 1°.

Runway beams: HE260M.

Further according to GA dwg. No.: E900-11915-M-00007-001.

The crane bridge is running on runway beams under flanges with sixteen (16) of single flange travel wheels. Crane bridge is equipped with rack and pinion drive and driven by electrical explosion proof single speed motors with fail safe brakes through gear and pinion. Limit switches are installed on the crane in addition to heavy duty bumpers in each end of the runway beams.

Crane is equipped with electrical wire hoist with four wire falls. The hoist motor is two speed of explosion proof design with fail safe brake. Overload switch and limit switches for top and bottom position are included. Wire drum grooved, and hoist is equipped with non-spark spooling device to ensure correct wire spooling on the drum. Wire rope is galvanized and of non-rotating type.

The trolley is running on 4 wheels. The trolley is provided with rack and pinion drive. Drive is by electrical explosion proof single speed motor with fail safe bake through gear and cross

shaft. Limit switches are installed on the crane in addition to heavy duty bumpers in each end of the crane.

### **Functional block diagram**

A functional block diagram (please see figure 6.4) was made to illustrate the interaction between the different systems in the crane. Giving the boundaries with power, support, and lifted load, as well as internal power distribution, energy, and signals.

### **IN/OUT Interfaces**

The IN/OUT interface list gave a description over the type of interface, e.g. power, energy, structural, the bounding system, interface location and reference drawing. As in the boundary definition it was defined that the boundary was given from electrical supply and runway supports to the actual handled load attached in the crane hook.

### **System work breakdown structure**

The SWBS was based on the TAG-lists retrieved from SAP and found in appendix C. It contained the components registered in SAP today with some manual addition taken from both the historic data, the drawings in the crane documentation and previous analysis'. The SWBS was grouped in the following order: TAG NO, Description, System, Subsystem, Type (Instrument only), Quantity and reference. 7 tags had been given a protection type and 4 were given a control type.

### **Equipment history**

The equipment history is a file compiled of the historic notification data from SAP. Usually the recommendation is to use history data from the last 2 or 3 years, in this case all the historic data accumulated on this machine were put into the equipment history, this were done because there was not a large quantity of data available. At least not for the last 2 or 3 years. The data were grouped on date, TAG, description, system, subsystem, failure mode and failure cause. Due to insufficient plotting of the data a large quantity of events lacked a good description of the actual cause of failure, and a large quantity of the data lacked a connection to the given tag. Some assumptions had to be done to group the data into the right tag and system as well as the cause of failure.

#### **6.4.4 System functions and functional failures**

Based on the SWBS a system functions list was made, listing each component functions. These functions were assigned one, two or several possible functional failures.

E.g. The function of the bridge drive motors is to move the bridge. Possible functional failures were that the bridge is not moving.

The functions were based upon the OUT interface of handling the load attached in the crane hook. This is the main objective to the crane. Either this handling is up, down, north, south, east, or west. Functions were listed with the support of functional description, drawings, schematics, component manufactures documentation and the analysts understanding of this system.



#### 6.4.5 Failure mode and effects analysis

Prior to the FMEA an equipment-functional failure matrix was made based on the functional failures identified in step 4. This equipment-functional failure matrix had initially 75 failure modes which in terms would lead to 17 unique functional failures.

During the FMEA it was observed that several of the failure modes could lead to several functional failures. The number of failure modes which lead to unique functional failures was lowered to 42.

#### 6.4.6 Logic Tree Analysis

Based upon the FMEA, the LTA was performed. 38 Failure modes were given a letter A, for safety related functional failure. A large portion of this failure modes were attributed to instruments which were given a control or safety designation in the SWBS. Other failure modes were attributed to structure safety.

23 failure modes were given a designation letter B, meaning that these failure modes would give significant outage but pose small safety consequences. In this section one will identify the crane drive in the bridge, trolley drive in the trolley and junction boxes. Designation letter B was given to the equipment if there was significant outage; significant outage was defined as a momentary stop in the EOT crane when a well intervention campaign is being performed, given all the equipment which is mobilized for well intervention and the frequency the EOT cranes are used.

#### 6.4.7 Task selection

The task selection step was performed in three sub-steps: Task selection process, sanity check and task comparison.

##### **Task selection**

In the initial task selection process were performed in the order of the prioritized PM tasks according to the LTA step. Due to the former established systems on bridge, hoist, instrument, other, runway and trolley the process and results will be listed in the same manner. Several of the tasks were given the effective info comment of "A Part of annual control", this was stated in the user manual (Dreggen Crane AS 2004a).

No Weibull analysis were performed as to lacking data to perform analysis on. Though. Intervals were used from previous analysis.

##### *Bridge*

For bridge-system the only grade A failure mode was related to the travel wheels. Structural failure in the travel wheels caused by massive degradation to structure. Task candidate was TD task of inspection and cleaning with estimate frequency of 1 year. This task is a part of annual control.

Other task part of annual control, selected TD task of inspection and cleaning, with the estimated frequency or 1 year were:

- Cable loop – FM: Broken, FC: Snagging in structures.
- Motor Travel – FM: Brake not releasing, FC: Worn Brake.
- Travel wheels – FM: Deformed, FC: Bearing failure.

The Motor for travel was given a TD selective task of lubrication with grease gun every 4 year to prevent the FM: Motor bearing defective.

To prevent the FM: Motor cage or rotor defective, with the FC: Age. A TD selective task of inspection and cleaning was scheduled every 3 years. The user manual for the motors states a reference to IEC 60079-17 which gives 3 years as the largest interval to check Ex d – Explosion-proof enclosures (Standard Norge 2016).

The gearboxes for travel were identified to have a FM of gearbox not rotating and a failure cause of broken gears. The selective PM task was a TD task for changing oil every 4 years, given by the user manual (Dreggen Crane AS 2004a).

Similar the drive pinion, drive chain and trolley gear rack were identified to have the FM of broken, by either FC: Missing or broken theets or aberration. The selective PM task was a TD task for lubrication every 1 year.

### *Hoist*

Hoist system had 13 failure modes given a category A from the LTA.

Several of these FM were given TD tasks which were stated in the user manual to be a part of the annual control, and thus, had a given interval of 1 year:

- Motor hoist, FM: Brake not engaging, FC: Wear and tear.
- Motor hoist, FM: Brake not engaging, FC: Worn brake.
- Block double, FM: Severe structural corrosion, FC: Lack of sufficient cross section in axle.
- Upper block, FM: Severe structural corrosion, FC: Lack of sufficient cross section in axle.
- Wire end connection outer, FM: Broken, FC: Broken because of misuse or severe deterioration.
- Wire end connection inner, FM: Broken, FC: Broken because of misuse or severe deterioration.

The drive motor had an identified FM: Motor bearing defective, FC: Insufficient lubrication. The selective TD task of lubrication with grease gun every 4 years were chosen.

The drive motor had an identified FM: Motor cage or rotor defective, FC: Age. This was like the bridge travel motors. An inspection of explosion proof motors must be done at least every 3 years. Thus, the selective TD task was inspection and clean every 3 years.

Gearbox had a FM of gearbox not rotating, FC was broken gears. A selective TD task was to check oil level every 1 year and change oil every 4 years.

Both the upper block and the lower block had an identified FM: Corrosion in bearings, FC: Water penetration in bearings. The selective TD task of lubrication with grease gun every 3 months were chosen to prevent water penetration.

Wire have several FM: Broken, Missing and Corroded, with applicable FC: Broken because of severe misuse, deterioration, or Lack of lubrication. For the first FM selective TD tasks were inspection of the wire rope every 1 month and changing the wire rope every year.

The FM of lack of lubrication was given a selective TD task for inspection of wire rope every 1 month and lubrication every 3 month.

For the hoist system 1 FM was identified and classified as category B in the LTA.

Drum bearings were given the selective TD PM task of lubrication with grease every year.

#### *Instrument*

The Instrument system had 20 identified FM which were given a designation A in the LTA.

Instrument and junction box (JB) OEMs had be observed to writes little or nothing in the user instructions about maintenance, and the little which is written was observed to state a reference to IEC 60079-17, which in terms were giving an instruction to inspect at least every 3 years. Using historic data and discussions from meetings, water penetration was a larger issue than to be inspected every 3 years. Thus, the selective task for several of the instruments would be a TD PM task of inspection and cleaning every 1 year. Applicable to the following components, FM, and FC:

- Switch pos. crane travel – FM: False indication, FC: Age.
- Switch pos. crane travel – FM: Broken, FC: Moisture in the electronics.
- Switch pos. top hoist – FM: False indication, FC: Age.
- Switch pos. bot hoist – FM: False indication, FC: Age.
- Switch pos. trolley travel – FM: False indication, FC: Age.
- Switch pos. trolley travel – FM: Broken, FC: Moisture.
- Overload switch – FM: False indication, FC: Moisture in the electronics.
- Switch emergency stop – FM: Shorted, FC: Moisture.
- Panel control, or radio remote – FM: Shorted, FC: Moisture.

The limit switch for hoist with the FM of incorrect setting, unknown FC were given a TD PM task of verifying limits every 3 months.

The overload switch for the hoist had an identified failure mode of incorrect setting, failure cause moisture. A TD PM task of verification of the limits were scheduled for every year.

4 failure modes for instrument were categorized B in the LTA.

The failure modes for instruments with category B were like instruments and junction boxes

stated under the category A failure modes and would give a selective TD PM task of inspection and cleaning once a year:

- Junction box – FM: Shorted, FC: Moisture.
- Box Junction overhead – FM: Shorted, FC: Moisture.
- Main switch – FM: Shorted, FC: Moisture.
- Push button station – FM: Shorted, FC: Moisture.

#### *Other*

In the system of other the only item was the pad eye for test, FM: overstress and FC: Tear out due to loss of cross section. Given a selective TD PM task checking for wear and tear every year, though this is a part of annual control.

#### *Runway*

In the system of Runway, the Runway beams were listed with a FM: Severe structural corrosion and FC: Lack of sufficient cross section in structural supports. This was a category A failure mode. The selective TD PM task was inspection and cleaning every year, though this is a part of annual control.

The bridge gear rack was listed with a FM: Broken, FC: Missing rack theets. This failure mode was given a selective TD PM task of lubrication every year, such as stated in the user instructions. This was category B.

#### *Trolley*

The trolley system was identified with 2 category A failure mode and 5 category B. Trolley wheels with FM: Severe structural corrosion and FC: Loss of sufficient cross section in axle and FM: Deformed with FC: Bearing failure were the category A failure modes. A selective TD PM task of inspection and cleaning was chosen with an interval of one year. This is a part of the annual control.

The motor for the trolley drive with FM: Motor bearing defective and FC: Insufficient lubrication was given the same selective TD PM task as the other motor bearing failure modes: Lubrication with grease gun every 4 years. Similar for the trolley drive motor with FM: Motor cage or rotor defective, the same selective TD PM task was given as for the other motor cage or defective rotor failure modes: Inspect and clean every 3 years. The FM: Brake not releasing, with FC: Worn brake had the same similarity and a part of the annual control, the selective TD PM task of inspection and cleaning every year was given.

The gearbox for the travel drive were identified with FM: Gearbox not rotating, FC: Broken gears. It was stated in the user manual to change the oil every 4 years, thus the selective TD PM task of changing the oil every 4 years was chosen.

The drive pinion with FM: Drive pinion not rotating, FC: Broken theets were like drive pinions installed in the other systems and stated in the user manual to be lubricated once a year. The drive pinion was given the selective TD PM task of lubrication every year.

### Sanity check

Only one functional failure was put on the RTF list and checked in the sanity check. This was the bumper. The bumper passed through the sanity check and got a continued RTF recommendation.

### Task comparison

Comparing the RCM scheduled task against the current PM program revealed some differences. Some of the components could not be identified to be covered by the current PM program, though this did not mean that these components are not a subject to maintenance, just that the descriptions available did not cover maintenance to these components. The identified PM tasks were described with their respective WS covering this task. The intervals given in the current PM program varies some from the intervals chosen in the RCM tasks. The tasks comparisons are given in the following tables.

**Table 6.18:** Task comparison 07025 bridge system.

TAG	Component Description	FM#	Failure Mode	RCM Selective dec.	Est Freq.	Current Task	Freq.
	BUMPER	2.1	Brittle	RTF			
	CABLE LOOP	3.1	Broken	1. Check for wear and tear or deformation - TD	1Y	WS-19OVER30.M	6M
30 07027	MOTOR TRAVEL CRANE OVERHEAD.	4.1	Motor bearing defective	1. Lubricate with grease gun. - TD	4Y		
30 07027	MOTOR TRAVEL CRANE OVERHEAD.	4.2	Motor cage or rotor defective	1. Inspect and clean - TD	3Y	WS-30MOTO68.E	1Y
30 07027	MOTOR TRAVEL CRANE OVERHEAD.	4.3	Brake not releasing	1. Inspect and clean - TD	1Y		
30 07028	MOTOR TRAVEL CRANE OVERHEAD.	5.1	Motor bearing defective	1. Lubricate with grease gun. - TD	4Y		
30 07028	MOTOR TRAVEL CRANE OVERHEAD.	5.2	Motor cage or rotor defective	1. Inspect and clean - TD	3Y	WS-30MOTO68.E	1Y
30 07028	MOTOR TRAVEL CRANE OVERHEAD.	5.3	Brake not releasing	1. Inspect and clean - TD	1Y		
	GEARBOX. MOTOR TRAVELLING	6.1	Gearbox not rotating	1. Change oil - TD	4Y	WS-19OVER46.M	4Y
	GEARBOX. MOTOR TRAVELLING	7.1	Gearbox not rotating	1. Change oil - TD	4Y	WS-19OVER46.M	4Y
	DRIVE PINION	8.1	Drive pinion not rotating	1. Lubricate with burshed or sprayed on grease - TD	1Y	WS-19OVER46.M	1Y
	TRAVEL WHEELS	9.2	Structural failure	1. Inspect and clean - TD	1Y	WS-19OVER30.M	6M
	TRAVEL WHEELS	9.1	Deformed	1. Inspect and clean - TD	1Y	WS-19OVER30.M	6M
	TROLLEY GEAR RACK	10.1	Broken	1. Lubricate with burshed or sprayed on grease - TD	1Y	WS-19OVER46.M	1Y

**Table 6.19:** Task comparison 07025 hoist system.

TAG	Component Description	FM#	Failure Mode	RCM Selective dec.	Est Freq.	Current Task	Freq.
30 07025	MOTOR HOIST. CRANE OVERHEAD	11.4	Brake not engaging	1. Inspect and clean - TD	1Y		
30 07025	MOTOR HOIST. CRANE OVERHEAD	11.1	Motor bearing defective	1. Lubricate with grease gun. - TD	4Y		
30 07025	MOTOR HOIST. CRANE OVERHEAD	11.2	Motor cage or rotor defective	1. Inspect and clean - TD	3Y	WS-30MOTO68.E	1Y
30 07025	MOTOR HOIST. CRANE OVERHEAD	11.3	Brake not releasing	1. Inspect and clean - TD	1Y	WS-19OVER33.M	6M
	GEARBOX	12.1	Gearbox not rotating	1. Verify oil level - TD 2. Change oil - TD	1. 1Y 2. 4Y	WS-19OVER46.M	4Y
	DRUM BEARINGS	13.1	Bearing failure	1. Lubricate with grease gun. - TD	1Y		
19 02819	BLOCK DOUBLE SHEAVE WITH HOOK	14.2	Severe structural corrosion	1. Inspect and clean - TD	1Y	WS-19OVER30.M	6M
19 02819	BLOCK DOUBLE SHEAVE WITH HOOK	14.1	Corrosion in bearings	1. Lubricate with grease gun. - TD	3M	WS-19OVER59.M	3M
	UPPER BLOCK	15.2	Severe structural corrosion	1. Inspect and clean - TD	1Y	WS-19OVER30.M	6M
	UPPER BLOCK	15.1	Corrosion in bearings	1. Lubricate with grease gun. - TD	3M	WS-19OVER59.M	3M
19 02820	WIRE 14 MM MIN BRUDD 20T	16.1	Broken	1. Inspect wire rope -TD 2. Change wire rope -TD	1. 1M 2. 1Y	WS-19OVER59.M	3M
19 02820	WIRE 14 MM MIN BRUDD 20T	16.2	Corroded	1. Inspect wire rope -TD 2. Lubricate wire rope -TD	1. 1M 2. 3M	WS-19OVER59.M	3M
	WIRE END CONNECTION OUTER	17.1	Broken	1. Inspect and clean - TD	1Y	WS-19OVER59.M	3M
	WIRE END CONNECTION	18.1	Severe structural corrosion	1. Inspect and clean - TD	1Y	WS-19OVER30.M	6M

**Table 6.20:** Task comparison 07025 instrument system.

TAG	Component Description	FM#	Failure Mode	RCM Selective dec.	Est Freq.	Current Task	Freq.
28 JE-07025	BOX JUNCTION OVERHEAD CRANE 19 07025	19.1	Shorted	1. Inspect and clean - TD	1Y	WS-19OVER30.M	6M
28 JE-07026	BOX JUNCTION OVERHEAD CRANE 19 07025	20.1	Shorted	1. Inspect and clean - TD	1Y	WS-19OVER30.M	6M
ZS-01872	SWITCH POS TRAVEL OVERH CRANE 19 07025	21.1	False indication	1. Inspect and clean - TD	1Y	WS-19OVER30.M	6M
ZS-01872	SWITCH POS TRAVEL OVERH CRANE 19 07025	21.1	False indication	1. Inspect and clean - TD	1Y	WS-19OVER30.M	6M
ZS-01872	SWITCH POS TRAVEL OVERH CRANE 19 07025	21.2	Broken	1. Inspect and clean - TD	1Y	WS-19OVER30.M	6M
ZS-01873	SWITCH POS TRAVEL OVERH CRANE 19 07025	22.1	False indication	1. Inspect and clean - TD	1Y	WS-19OVER30.M	6M
ZS-01873	SWITCH POS TRAVEL OVERH CRANE 19 07025	22.1	False indication	1. Inspect and clean - TD	1Y	WS-19OVER30.M	6M
ZS-01873	SWITCH POS TRAVEL OVERH CRANE 19 07025	22.2	Broken	1. Inspect and clean - TD	1Y	WS-19OVER30.M	6M
ZS-01868	SW LIMIT POS HOOK TOP OVERH CRANE 19 07025	23.1	False indication	1. Inspect and clean - TD	1Y	WS-19OVER30.M	6M
ZS-01868	SW LIMIT POS HOOK TOP OVERH CRANE 19 07025	23.2	Incorrect setting	1. Verify limits -TD	3M	WS-19OVER30.M	6M
ZS-01869	SW LIMIT POS HOOK BOTT OVERH CRANE 19 07025	24.1	False indication	1. Inspect and clean - TD	1Y	WS-19OVER30.M	6M
ZS-01869	SW LIMIT POS HOOK BOTT OVERH CRANE 19 07025	24.2	Incorrect setting	1. Verify limits -TD	3M	WS-19OVER30.M	6M
ZS-01870	SWITCH POS TROLLY OVERH CRANE 19 07025	25.1	False indication	1. Inspect and clean - TD	1Y	WS-19OVER30.M	6M
ZS-01871	SWITCH POS TROLLY OVERH CRANE 19 07025	26.1	False indication	1. Inspect and clean - TD	1Y	WS-19OVER30.M	6M
ZS-01871	SWITCH POS TROLLY OVERH CRANE 19 07025	26.2	Broken	1. Inspect and clean - TD	1Y	WS-19OVER30.M	6M
	OVERLOAD SWITCH HOIST	27.1	False indication	1. Inspect and clean - TD	1Y	WS-19OVER33.M	6M
	OVERLOAD SWITCH HOIST	27.2	Incorrect setting	1. Verify limits	1Y	WS-19OVER33.M	6M
28 07025	SWITCH MAIN FOR OVERHEAD CRANE 19 07025	28.1	Shorted	1. Inspect and clean - TD	1Y		
28 07026	SWITCH PUSH BUTTON STATION FOR 19 07025	29.1	Shorted	1. Inspect and clean - TD	1Y		
28 08296	SWITCH EMERG STOP CRANE 19 07025	30.1	Shorted	1. Inspect and clean - TD	1Y		
LCP-07025	PANEL CONTROL OVERHEAD CRANE 19 07025	31.1	Shorted	1. Inspect and clean - TD	1Y	WS-19OVER30.M	6M



**Table 6.21:** Task comparison 07025 other system.

TAG	Component Description	FM#	Failure Mode	RCM Selective dec.	Est Freq.	Current Task	Freq.
19 07560	PADEYE TEST SWL 25T (FOR OT CRANE )	32.1	Overstress	1. Check for wear and tear or deformation - TD	1Y		

**Table 6.22:** Task comparison 07025 runway system.

TAG	Component Description	FM#	Failure Mode	RCM Selective dec.	Est Freq.	Current Task	Freq.
	BRIDGE GEAR RACK	33.1	Broken	1. Lubricate with burshed or sprayed on grease - TD	1Y	WS-19OVER30.M	6M
	RUNWAY BEAMS	34.1	Severe structural corrosion	1. Inspect and clean - TD	1Y	WS-19OVER30.M	6M

**Table 6.23:** Task comparison 07025 trolley system.

TAG	Component Description	FM#	Failure Mode	RCM Selective dec.	Est Freq.	Current Task	Freq.
	TROLLEY TRAVEL WHEELS	35.1	Severe structural corrosion	1. Inspect and clean - TD	1Y	WS-19OVER30.M	6M
	TROLLEY TRAVEL WHEELS	35.1	Deformed	1. Inspect and clean - TD	1Y	WS-19OVER30.M	6M
30 07026	MOTOR TROLLEY. CRANE OVERHEAD 19 07020	36.1	Motor bearing defective	1. Lubricate with grease gun. - TD	4Y		
30 07026	MOTOR TROLLEY. CRANE OVERHEAD 19 07020	36.2	Motor cage or rotor defective	1. Inspect and clean - TD	3Y	WS-30MOTO68.E	1Y
30 07026	MOTOR TROLLEY. CRANE OVERHEAD 19 07020	36.3	Brake not releasing	1. Inspect and clean - TD	1Y		
	GEARBOX TROLLEY MOTOR	37.1	Gearbox not rotating	1. Change oil - TD	4Y	WS-19OVER46.M	4Y
	PINION TROLLEY DRIVE	38.1	Drive pinion not rotating	1. Lubricate with burshed or sprayed on grease - TD	1Y	WS-19OVER46.M	1Y

## 7 Discussion

In this chapter the results from the analysis will be discussed and reviewed against both the problem formulation and the theory.

### 7.1 25 T Crane 07010

Going through the priorities of the notifications it was observed 80% of the registered notifications were of priority 1 or 2, giving a rectification deadline of 3 to 6 months. This would be notifications which do not give total downtime on the crane. A significant amount of the notifications was of priority E and thus have 14 days rectifications deadline. This were the kind of notifications which will stop the crane. Thus, most of the notifications contributes to little actual down time on the crane and could be facilitated by maintenance personnel outside the well intervention campaigns.

Revising the pareto diagrams and the equipment history to facilitate for the modifications done on the cranes allowed to focus the effort of the RCM analysis on the equipment history which in terms is relevant.

Looking through the revised pareto diagrams presented in the section for information collection in the analysis. One can observe 80% of all notifications is from instrument and hoist. Going through the analysis the following components had sufficient amount of notifications to be used in a Weibull analysis of the failure pattern or was simply a component of interest, and will be discussed:

- Drive chain – System: Bridge.
- Intermittent gearbox – System: Hoist.
- Wire rope – System: Hoist.
- Anti-collision – System: Instrument.
- Push button station – System: Instrument.
- Limit switch hoist – System: Instrument.
- Overload switch – System: Instrument.

Based on the data presented. The drive chain would have a reliability rate of 80% if it was not maintained or changed within 450 days or about 1 year and 3 months, and still had a MTBF of 1736 days. The shape factor was 0,96 which was indicating a constant failure rate. Which in terms was logical as the part was changed and new after the initial failure. In a meeting (ConocoPhillips 2018c) this was discussed and informed about this component had no scheduled intervals for lubrication, inspection, or cleaning in the initial PM program and the same for the PM instructions given from the manufacturer. Though, as an initial mitigation to the notifications, a Time-directed PM task for lubrication and inspection every 3 months were put in the program.

The intermittent gearbox for the hoist, which OEM was Brevini, now called Dana Brevini, was given a 4-year interval of changing oil from the crane manufacturer Dreggen. Though Brevini stated in the original instructions for the gearbox oil were to be changed every year or 1000 hours, whichever occurred first. Although there had been no notifications on the gearbox, the TD PM

task was recommended to 1 year opposed to the 4-year interval written in the instructions form Dreggen.

The Wire Rope was the system which has the largest amount of notifications. A reliability rate of 83,83% was calculated given the wire rope was changed every 3 months. This was with a MTBF of 292 days. Though the wire rope was calculated to have a shape factor of 1,3 which indicates a slight wearing out failure, this could not be as the wire rope was changed quite often. Though, after some discussion this could be assumed to be from an increased use of the crane as a results of more intensive well invention campaigns as opposed to earlier. Changing the wire rope every 3 months were quite drastic and should not be necessary. In a discussion in a meeting (ConocoPhillips 2018c) it was informed about this issue; the cranes were designed in a way which do allow almost no fleet angle, ConocoPhillips had challenged Dreggen earlier to come up with a solution, but no solutions were presented.

Anti-collision system was indicated under several meetings to be a system of frustration, more downtime induced than collisions prevented (ConocoPhillips 2018e). Though looking through the equipment history no actual trend could be identified. Could be that not everything was recorded as notifications or there were several failure modes. Though. The essence which was extracted from the equipment history was a major problem with moisture or dirt on the lasers which in terms gave false indication and results in the cranes were driven with an override on the anti-collision system. A modification with heat tracing could be a solution to prevent moisture from fogging the laser lenses. The interval of 3 months for inspection and cleaning was given to keep this from becoming an issue under well intervention campaign.

The failures related to push button station were related to the defective failure mode, and the failure cause was thought to be moisture and excessive handling. The frequency of failures related to the push button station or pendant had decreased after modifications work was done and radio remote control was utilized as main means of operation. Because of this the TD PM task of inspection and cleaning was given even though a Weibull analysis will give an 80,36% reliability if no maintenance action was given within 265 days of operation. The same analysis gave a MTBF of 341 days.

Limit switch hoist had the reoccurring failure mode of incorrect setting. 80% reliability was achieved if the limit was checked every 140 days, a 90-day interval gives the reliability of 86%. MTBF was 341 days. The shape factor was 0,78 indicating infant failures. The failure cause was not identified and should probably be investigated as it was odd behaviour when the limit switches setting was changed over time.

The same failure mode as for the limit switch; incorrect setting, was present in the overload switch for the hoist. A reliability of 82,60% could be achieved by verifying the limits every 9 months. MTBF was 997 days. No failure cause had been identified and the matter should probably be investigating as the limit switch above.

The sanity check proved useful as it caught the two heaters for bridge travelling motors. The heaters were initially put on the RTF-list, but it proved through the sanity check to be a conflict with both OEM maintenance instructions and regulatory conflict. Though the Bumper was kept on the RTF-list.

In the task comparison of the analysis the current PM program were compared to the RCM

PM program. It was not possible to identify all the PM tasks in the current PM program, safety-related tasks such as inspection of the brake was a part of the annual control per requirement in NORSOK R-003, though this were not reflected in the PM program. The inspection and cleaning of electrical equipment were done in areas and were not a part of machine or equipment specific maintenance program (ConocoPhillips 2018c).

## 7.2 25 T Crane 07015

Going through the notifications for this crane it was observed 80% of the notifications were of type priority 1 or priority E. Giving the deadline of 3 months or 2 weeks. The priority E would in this case be the most interesting ones as these notifications have probably caused direct downtime on the crane and at the same time made material handling in the well intervention areas more difficult.

Revising the pareto diagrams and the equipment history to facilitate for the modifications done on the cranes would allow to focus the effort of the RCM analysis on the equipment history which in terms was relevant.

Going through the revised pareto diagram it was observed almost 80% of the notifications were related to the instrument system, though some of the hoist system notifications had to be included to achieve 80%. The following components had sufficient amount of notifications or were for some other reason a component of interest which in terms could be put into system and analysed in the Weibull analysis, and are hence discussed:

- Intermittent gearbox – System: Hoist.
- Wire rope - System: Hoist.
- Anti-collision – System: Instrument.
- Limit switch hoist – System: Instrument.

The intermittent gearbox for the hoist were like the 07010-crane. Thus, an interval of oil changes every year were given in the revised PM program as this was the OEM recommendations.

The Weibull analysis for the main gearbox showed a 90,71% reliability of having the right amount of oil, if the oil was changed and gearbox was inspected every 4 years. MTBF was 1811 days. The shape factor was 8,92. Indicating a wearing out failure. This could be a result of increased use, or simply the gearbox had increased leakage.

Wire rope with FM Broken had through the Weibull analysis shown to achieve 81,10% reliability if the wire rope was changed every six months, the MTBF was 599 days. A shape factor of 1,17 indicating a slight wearing out mode, though, if the wire rope was changed it could not wear out the same way as another maintained component. Similar here, the crane construction seemed to be an issue, rather than the user, as the cranes allowed small to none fleet angle on the wire rope when used.

The anti-collision system had a bad reputation according to discussions in meetings (ConocoPhillips 2018d). A large problem of fogging due to moisture build-up were giving the lasers a reliability of 80,24% if cleaned and inspected every 46 days. MTBF is 456 days. Though this problem could probably be avoided if the moisture was prevented. Prevention of moisture should

be applicable if heat tracing were installed to keep a constant temperature of the lasers.

The failure mode of incorrect setting in the limit switch for hoist would have a reliability of 80,14% if the limits were checked in the interval of 165 days. A 90 days interval would give a slightly higher reliability of 86,87%. MTBF was 1055 days. The failure cause here was unknown, or at least could not be identified. Further actions should be taken to understand the root cause and prevent it from changing the setting of the crane.

In this sanity check nothing was actual changed. This was due to the identification of the heaters from the analysis of 07010-crane. Thus, the heaters were included on an earlier point in the analysis.

The task comparison was almost identical to the 07010-crane. Only this crane did not have the test padeye.

### 7.3 25 T Cranes

The priorities in notifications were observed to be somewhat different between the two 25T cranes. No apparent pattern emerges. Could be random. Though on the amount of notifications recorded it would seem like the TAG No. 07010 were the crane which is most often in use, right behind one will find the TAG No. 07015.

Inspection of Ex d-motors were done on an annual basis. Though this could be done every 3-years according to the regulations. No apparent equipment history was pointing to having this frequent interval, but it could off course be set from learning offshore. The interval was purposed changed in the RCM analysis on both the cranes, and it should be monitored which effect this change will have.

Both the 25T cranes had installed the anti-collision system. On both the cranes similar problems arised with fogging of the lenses due to moisture. This is a safety system to prevent collision between cranes and between cranes and risers and should be functional all the time. By installing means to prevent the fogging; heat tracing, it should be possible to avoid this problem. This should be considered as opposed to using large amount of resources with rope access or scaffolding to clean and inspect the lasers every 3 months.

Looking to the limit switch for hoist, with the failure mode of incorrect setting. This was a bit odd failure mode, as this limit switch was on a rotary cam, it should not change over time. Could it be that this failure mode was apparent after cutting the wire rope? Further investigation is needed in terms of identifying the root cause.

### 7.4 15 T Crane 07020

Priorities found in the notification history on this crane were not like the 25T cranes. Most of priority 2, and priority 1 notifications were found. None of the priority E.

Same as for the other cranes the wire rope was a component which gave several notifications. Analysed by Weibull analysis a reliability rate of 80,42% and MTBF of 1360 days would be achieved if the wire rope was changed every 150 days. The shape factor of 0,65 indicated infant

failures and would give a more accurate picture as the wire rope cannot wear out once changed every time a notification was entered. The intervals between seems random and could probably be more related to usage pattern. The continuously damaged wire rope could have a correlation to the same design fault as for the larger cranes, combined with the usage of the crane.

The overload switch had the failure mode of incorrect setting. A reliability of over 90% were achieved if the limits were checked at least every 3 years. MTBF was 1498 days. The failure cause of this change in settings were unknown. Though it was observed that this happened with both the 25 T cranes and this 15 T crane. Further actions to explore the root cause should be considered.

The sanity check and task comparison hold large similarities to the larger cranes. The same components were identified and for the sanity check only one item was checked from the RTF-list, this was the bumper, which in terms are kept on the RTF-list.

## 7.5 15 T Crane 07025

Like the 07020-crane the priorities were not like the 25T cranes. Most of priority 1 and priority 2 was identified. Close to 100% in fact. None of the identified notifications had a priority E.

No Weibull analysis were performed for this crane, as it had not sufficient amount of reoccurring notifications. Though it was observed some reoccurring problems with the wire rope, which in terms could be related to similar problems with the design of crane and the fleet angle of the wire rope.

## 7.6 15 T Cranes

The cranes do not show the same pattern in notification priority, as the 07020-crane has the largest amount of priority 2 and the 07025-crane has the largest amount of priority 1 notifications. Making the idea of inherent randomness in the notifications seem plausible.

As for the 25T cranes the wire rope is an issue. Often damaged. The same failure cause is postulated. A design flaw which in terms allow only very small fleet angles.

## 7.7 The Ekofisk M Cranes

Initially the plan was to use the ISO 14224 standard (Petroleum, petrochemical and natural gas industries – Collection and exchange of reliability and maintenance data for equipment) to break down the cranes in to systems and subsystems. Though, this standard did not have an applicable system overview for EOT cranes, a system structure had to be made from scratch and was used in this thesis work.

The priority of notifications seemed to be random at times for the cranes. As the larger cranes had not only a larger amount of notifications in total, also a shorter period of rectifications, e.g. higher priority on the notifications, 1 or E. There was no identifiable pattern, though it could be assumed the use of the cranes would have a significant role in both the priority and the occurrence of notifications.



Looking through the notification history on all the cranes, many columns had not been utilized in the analysis: Maintenance planner, User status, Order number, Main Work Control, and system status as they were a part of a work process in the SAP system. The notification group was a good indicator as it would tell if the notifications were registered by the enterprise of competence or by the user. The description was utilized, but often only referred to the actual crane, and not the component. Same applied to the functional location, reason could be the operator had difficulties identifying the right TAG No. to put the notification on. The description given was usually very detailed and gave a thorough explanation of the component which had failed. Though, not the missing function, failure mode or the most important one: failure cause. The failure cause was usually not identified in the notification, making it difficult for the analyst to know how to prevent the occurrence of the given failure.

The documentation for the cranes could be somewhat confusing. After modification work performed in 2009, only the documentation for the actual modification was changed. Leaving the old original documentation, the same. This resulted in some of the documentation to be updated and contained a complete picture of the cranes and other documentation has older references. For revisions the documents are available in both old and new revisions sorted in SAP.

A review of the TAG list against the machine and the equipment history should be performed to make a gap analysis between the maintenance done and what was recommended by the analysis.

The failure modes and effect analysis has shown that the quality of analysis depends largely on the equipment history, the documentation available and the analysts experience and knowledge. A weakness in the whole RCM analysis performed is in fact the analyst, the quality is strongly dependent on the analyst experience and knowledge and should be quality checked prior to deployment. Failure modes can have been missed, or equipment history misinterpreted, and so on.

Consequence classification of the cranes were stated as low to medium, dependent on which component and crane. This classification should probably be changed as the governing documentation to ConocoPhillips restricts RCM methods from being applied to equipment with lower classification. The governing documentation which in terms gave an overview over what equipment is consequence classified how, was looking as it was more related to process safety than material handling, though, still the cranes should probably have a higher consequence classification.

The reliability rate was chosen to be 80% in the analysis. No regulatory demands were identified. Prior to using RCM methods, a reliability rate should be set. The MTBF values in the analysis were presented to give some understanding in how large the difference was if the analyst were to base the analysis on MTBF in contrary to Weibull analysis. MTBF should not be used if the reliability rate is to be higher than 50%.

Weibull analysis were performed subsystems where at least 3 data points were identified. I.e. to data points plus initial start date for the recording of notifications. With as few data points as two occurrence of failure, the failures could be inherent random and not following any pattern. Thus, the strength of the following analysis results could be questioned:

- Drive chain bridge TAG No.:07010.



- Limit switch hoist TAG No.:07010.
- Gear hoist TAG No.:07015.
- Overload switch hoist TAG No.:07020.

Though, together with comparative results from all the cranes, data for decision in task selection process should be sufficient.

The EX electrical equipment PM showed to be present today, and inspection and cleaning is done on an area basis, more than equipment basis. This new info would make the task comparison part of the analysis look different.

As the repeatedly damaged wire rope seemed to be a problem on all the cranes. With the cause of fleet angle to be larger under usage than the crane permits should probably be investigated further such as the wire rope does not need to be changed as often as the analysis shows. Understandable this will result in some design change in the crane.

The limit switches for the hoist were at the same proving to be a problem on several crane. A root cause analysis should be performed to identify why the limits are changing. This analysis will be different from the 25 T cranes to the 15 T cranes as the 25 T cranes utilizes a rotating cam switch and the 15 T cranes uses only a normal switch.

Looking through the purposed PM program after the RCM analysis, this looks to be a more inspection-based PM program. Changing the methodology to Condition-Based Maintenance (CBM). In many areas it is sufficient to provide inspection instead of dismantling a machine and change a lot of parts. The new PM program will reside on continuous improvement, using accumulated equipment history to improve the intervals and tasks for maintenance.

One larger restriction for the RCM methodology are presented through the NORSOK R-003, it is stated the maintenance are to be according to the manufactures instructions. The text is somewhat ambiguous. Does this interpret as an analyst cannot do any changes to the maintenance program which are not in accordance with the manufactures instructions, preventing optimization to give longer intervals? Or is it simply that an analyst needs to involve the manufacturer in the optimization analysis? The same standard refers to using a risk analysis on component level and RCM-based PM program.

## 7.8 General framework

As a part of the initial problem formulation a task was to look if the RCM methodology could be utilized on general cranes. Looking through the analysis, it can be transferred to any machine which has the right conditions.

First, the analyst will need access to the equipment history, and it is assuming that the same difficulties of identifying failure modes and failure causes will arise as the crane. Though, usually the failure mode will be identified. Further on the equipment documentation will be needed to be reviewed.

When the boundaries definitions are set, it is to continue the SWBS, through the functional failure analysis and the FMEA. The FMEA can be performed in the same manner, identifying conse-

quence of functional failure. At last the task selection, sanity check and task comparison can be performed.

Though this is a tedious work and should only be performed if needed, and on equipment with high consequence classification as per governing documentation. The reliability rate should also be predefined.

## 8 Conclusion

Looking to the introduction. The cranes in question have a use pattern where they are used 10 to 15 days every third months. During the well intervention campaigns where the cranes are used, they are used almost all day and night, by personnel who are not quite familiar with the cranes and are not maintaining them.

The inspection and maintenance instructions from Dreggen recommends annual maintenance, these instructions are not aligned with the current use of the cranes.

The problem text was formulated:

*“How could the inspection and maintenance regime be enhanced to facilitate this particular use case?”*

With the sub-objectives of:

- Give recommendations for new or revised Preventive Maintenance (PM) program for the two 25 tonnes and two 15 tonnes EOT cranes.
- Use the basis of work done on the EOT cranes to discuss if it could be used as a framework to enhance inspection and maintenance on general cranes, hoists, and winches on offshore installations.

Looking through the analysis and discussion, one can conclude that the inspection and maintenance regime can be enhanced to facilitate the use case with reliability methodology such as RCM.

By gathering reliability data of preventive maintenance, corrective maintenance, and use. One will be able to use this data to identify the failure modes and failures causes, and again use this information to continuously improve the inspection and maintenance program. As in the analysis work in this thesis that could be done by e.g. Weibull analysis of respective failure modes, where it will be possible to predict to some extent when the component will need maintenance to keep its function. The probability of which is set by the reliability rate, which in terms will set the level of reliability expected of the system.

The first sub-objective was achieved by using the reliability methodology given in the methodology chapter 4 and doing the analysis which are described in chapter 6. The complete analysis material are available in appendix E. The key is to enhance the PM program to fit the individual machine, and usage pattern.

As for the sub-objective of using the basis of the work done on the overhead travelling cranes to discuss if it could be used as a frame work, this was done in chapter 7. The same will apply as for the EOT cranes. Though this work will be tedious and should not be performed on equipment with low consequence classification according to ConocoPhillips governing documentation.

### 8.1 Recommendations and further work

To continuously improve the PM program, one will need to live the PM program; After implementing the RCM tasks, one will need to monitor and report results. Results has to be measured

for effectiveness and evaluated. Evaluation will determine if the PM task is optimal or needs further improvement.

Notifications and reporting are set into a system, but reliability is not in focus, to get the reliability of functions in focus some changes are needed. The target will be to preserve functions, and all reported notifications should have an identification column for failure modes as well as failure cause if possible. If a failure mode presents itself often, a root cause analysis should be performed. To use the repeated failure modes for Weibull analysis, an acceptable reliability rate must be set.

A thorough review of the TAG list should be performed to identify excess TAGS and implement new TAGS which are represented in the notification history.

The consequence classifications of the cranes should be checked and perhaps changed into a more severe consequence classification.

## References

- Aibel AS (2010a), *Technical & Functional Description*, Document No. EKOM-VA-G-00039.
- Aibel AS (2010b), *Technical & Functional Description*, Document No. EKOM-VA-G-00050.
- Aibel AS (2011), *Electric Overhead Crane SWL 25 Tons detail drawing w/part list*, Document No. E900-11915-M-00037.
- Bhatia, A. (2012), *PDHonline Course M245 (4 PDH) - Electric Overhead Traveling (EOT) Cranes and Hoists*, PDH Online.
- Bye, P. I. (2009), *Vedlikehold og driftsikkerhet*, 1nd edn, Tapir, Trondheim.
- Cassidy, P. (2014), *A Brief History Of The Overhead Crane*, Peter Cassidy (Leeds) Limited. Retrieved: 11. February 2018.  
**URL:** <http://www.petercassidy.co.uk/a-brief-history-of-the-overhead-crane/>
- ConocoPhillips (2013), *ConocoPhillips Engineering Numbering System (COPENS)*, Document No. 2169E.
- ConocoPhillips (2016), *Vedlikeholdsstyring*, Document No. 4963N.
- ConocoPhillips (2017), *PM Program development and Spare Parts Evaluations*, Document No. 6253.
- ConocoPhillips (2018a), *Consequence Classification of Equipment*, Document No. 5047.
- ConocoPhillips (2018b), *Minutes of Meeting 12th of February 2018*, ConocoPhillips.
- ConocoPhillips (2018c), *Minutes of Meeting 18th of April 2018*, ConocoPhillips.
- ConocoPhillips (2018d), *Minutes of Meeting 22th of January 2018*, ConocoPhillips.
- ConocoPhillips (2018e), *Minutes of Meeting 8th of February 2018*, ConocoPhillips.
- ConocoPhillips (2018f), *Operations*, Conocophillips AS. Retrieved: 27. January 2018.  
**URL:** <http://www.conocophillips.com/operations/>
- ConocoPhillips (2018g), *Våre norske operasjoner*, Conocophillips AS. Retrieved: 27. January 2018.  
**URL:** <http://www.conocophillips.no/nn/vare-norske-operasjoner/>
- Dreggen Crane AS (2004a), *Installation, Commissioning, Operation and Maintenance instructions for EOT cranes*, Document No. E900-11915-M-00056.
- Dreggen Crane AS (2004b), *Manufacturing Record Book for Electric Overhead Traveling cranes*, Document No. E900-11915-M-00068.
- Dreggen Crane AS (2004c), *TECHNICAL AND FUNCTIONAL DESCRIPTION*, Document No. E900-11915-M-00021.
- Emmerhoff, M. (2017), *Dagens vedlikehold og arbeidsbeskrivelser*, E-mail.
- Gjerde, T. (2018), *[EXTERNAL]Notifikasjoner*, E-mail.

- Gupta, G. & Mishra, R. P. (2016), 'A swot analysis of reliability centered maintenance framework', *Journal of Quality in Maintenance Engineering* **22**(2), 130–145.
- Kumar, R. & Kumar, U. (2004), 'A conceptual framework for the development of a service delivery strategy for industrial systems and products', *Journal of Business & Industrial Marketing* **19**(5), 310–319.
- Maritimt Magasin (2012), *Palfinger kjøper Bergen Group Dreggen*, Maritimt Magasin. Retrieved: 28. January 2018.  
**URL:** <http://maritimt.com/nb/maritimt-magasin/palfinger-dreggen-kjoper-kranprodusent>
- Moubray, J. (1997), *Reliability-centred maintenance*, 2nd ed. edn, Butterworth-Heinemann, Oxford.
- Paaske, S. (2017), *Brønnintervensjon*, Nasjonal digital læringsarena (NDLA). Retrieved: 28. January 2018.  
**URL:** <https://ndla.no/nb/node/178765?fag=137414>
- PSA (2018), *Guidelines*, Petroleum Safety Authority.  
**URL:** <http://www.ptil.no/guidelines/category218.html>
- PTIL (2015), *Ord og uttrykk i petroleumsvirksomheten*, Petroleumstilsynet (PTIL). Retrieved: 28. January 2018.  
**URL:** <http://www.ptil.no/ord-og-uttrykk/category38.html>
- Regjeringen (2016), *Norsk oljehistorie på 5 minutter*, Regjeringen. Retrieved: 28. January 2018.  
**URL:** <https://www.regjeringen.no/no/tema/energi/olje-og-gass/norsk-oljehistorie-pa-5-minutter/id440538/>
- Skipsrevyen (2012), *Bergen Group Dreggen 25 år*, Skipsrevyen. Retrieved: 28. January 2018.  
**URL:** <https://www.skipsrevyen.no/bergen-group-dreggen-25-ar/>
- Smith, A. M. & Hinchcliffe, G. R. (2004), *RCM : gateway to world class maintenance*, Elsevier Butterworth-Heinemann, Amsterdam ;.
- Standard Norge (2016), *NEK 420A:2016 - Electrical installations in potential explosive atmospheres*, Standard Online AS, Oslo, Norge.
- Standard Norge (2017a), *NORSOK R-002:2017 - Lifting equipment*, Standard Online AS, Oslo, Norge.
- Standard Norge (2017b), *NORSOK R-003 N:2017 - Sikker bruk av løfteutstyr. Rev. 3, Juni 2017*, Standard Online AS, Oslo, Norge.
- Standard Norge (2017c), *NORSOK Z-008:2017 - Risk based maintenance and consequence classification*, Standard Online AS, Oslo, Norge.
- Tinga, T. (2013), 'Principles of loads and failure mechanisms : Applications in maintenance, reliability and design'.
- Yin, R. K. (2014), *Case study research : design and methods*, 5th ed. edn, SAGE, Los Angeles, Calif.

## A Electric Overhead Traveling crane assembly

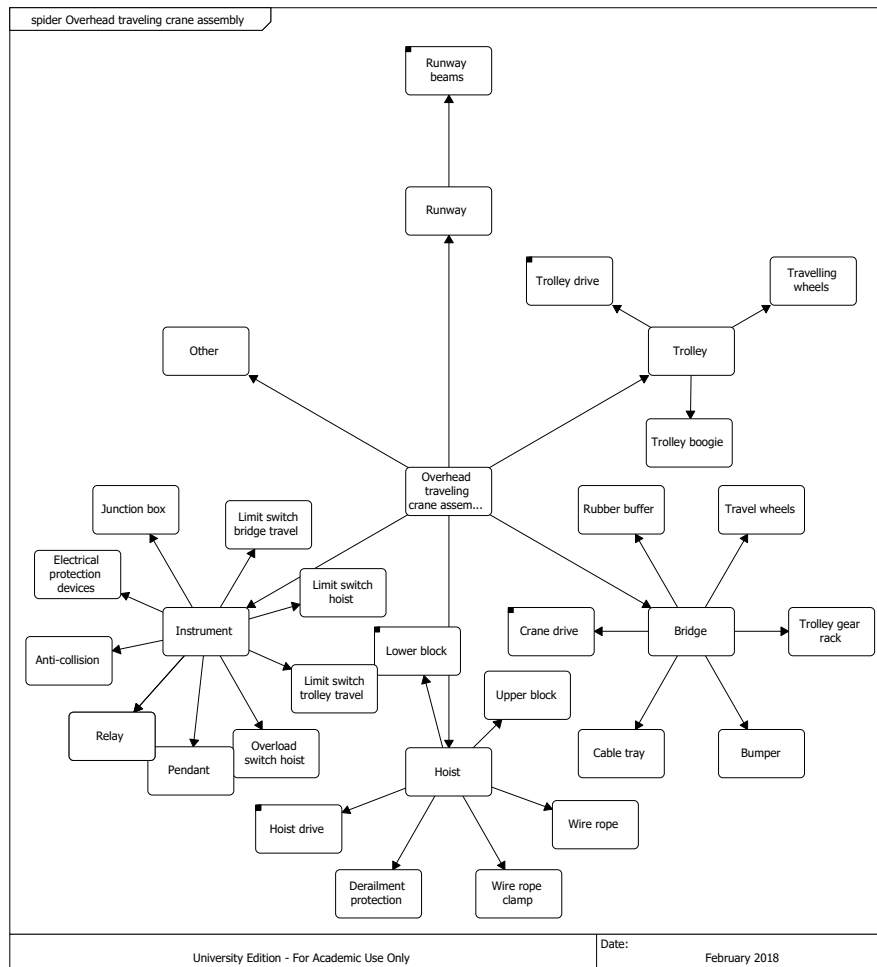



## B COPSAS' risk matrix

Risikomatrixe-for bruk i til prioritering av M1- notifikasjoner						
Samsynlighet	- Prioritet 3 (Low)		- Prioritet 2 (Medium)		- Prioritet 1 (High)	
	3M	6M	12M	18M	3Y	Revurdere notifikasjon
Hendelse har skjedd, eller scenariet vil mest sannsynlig skje innen 1 mnd	5	4	3	2	1	
Vil mest sannsynlig skje innen 3 mnd						
Vil mest sannsynlig skje innen 12 mnd						
Vil mest sannsynlig skje innen 3 år						
Vil mest sannsynlig skje senere enn 3 år. Scenariet knyttet til feilen er lite sannsynlig.						
<b>KONSEKVENSNES</b> av vanlig scenario/hendelse:						
for sikkerhet, dvs. akutte pers onskader	S					
for økonomi, dvs. produksjons tap og tap av materiell	EC					
for miljø, dvs. utslipp av miljøskadelige stoffer: Olfje, Svart/Bød Kjenn. Gull Kjenn. Gvern	EE					
for arbeidsmiljø, f. eks. konsekvenser relatert til støy, kjemisk eksponering etc.	WE					
* For HSE-relaterte feil i rodt og hvitt område skal plattformledelsen innføre straks tiltak slik at risikoen blir akseptabel. I den tekniske gjennomgangen skal man deretter vurdere tidsfrist for permanent løsning basert på risiko etter at risikoreduerende eller kompenserende tiltak er iverksatt. Ref. Dok. 4963, Kap. 3.6.						
1: Scenario	2: Konsekvens	3: Samsynlighet	4: Risk-Uten komp. tiltak (UNMIT)	5: QA-sjekk (Notifikasjons møter)	6: Komp tiltak implementert	7: Risk-Med komp. tiltak (MIT)
• Hva kan skje som følge av hendelsen eller feilen som er undersøkt, og om ikke den tilbredes?	• Konsekvens: Hva er en konsekvens? Konsekvens av scenariet vil inntruffe • for de 4 konsekvens-kategoriene: (S, EC, EE, WE) • Ta hensyn til konsekvens klassifisering	• Samsynlighet: Hva er samsynlighet for et scenario? Vil inntruffe	• Angi Risk verdiforutsetning (f.eks.: EC-B-3). • Angi Prioritet og RED	• Ledelsen kvalitetssikker NOT, og beslutning om kompenserende tiltak. • Tiltak som skal følges opp settes som "Tusk" på NOT.	• Beskriv kompenserende tiltak som er knyttet til hendelsen og RED • Tiltak som skal følges opp settes som "Tusk" på NOT.	• Angi risk verdi etter kompensering • Angi Prioritet og RED

Rev. 9. Mar. 2016

## C SAP TAG Structure

### C.1 TAG No. 07010

Functional loc.	BD/EKOM/840/19 07010	Description	SKID CRANE OVERHEAD TRAVELLING 25 T	Valid From	05.03.18		
<input checked="" type="checkbox"/>	BD/EKOM/840/19 07010	SKID CRANE OVERHEAD TRAVELLING 25 T	U133M				
<input checked="" type="checkbox"/>	BD/EKOM/19 02823	BLOCK DOUBLE SHEAVE WITH HOOK	U133M				
<input checked="" type="checkbox"/>	BD/EKOM/19 02824	WIRE 18 MM MIN BRUDD 32,9 T	U133M				
<input checked="" type="checkbox"/>	10878626	ROPE,WIRE,18 MM DIA,58.7M LG,FLEXPACK	N			1	EA
<input checked="" type="checkbox"/>	BD/EKOM/19 07010	CRANE OVERHEAD TRAVELLING 25 T NORTH	U133M				
<input checked="" type="checkbox"/>	10878336	SWITCH, PROX,NJ20+U1+N, PEPPERL & FUCHS	N			4	EA
<input checked="" type="checkbox"/>	10878370	SW,LIMIT,2S-336-112,SCHMERSAL,4A/230VAC	N			1	EA
<input checked="" type="checkbox"/>	10878371	SWITCH,LIMIT,125BM-499.B5,STROMAG	N			1	EA
<input checked="" type="checkbox"/>	10878298	CHAIN,DRAG,200.12.150,ASI AUTOMATIKK	N			1	EA
<input checked="" type="checkbox"/>	10878299	CHAIN,DRAG,26.20.150.0,ASI AUTOMATIKK	N			1	EA
<input checked="" type="checkbox"/>	10878623	STATION,CNTL,FNDNT,XBW 5AS142,TELEMEC	N			1	EA
<input checked="" type="checkbox"/>	10878466	BRG,RASEY-45,INA, FOR CRANE DRIVE, FOOT	N			17	EA
<input checked="" type="checkbox"/>	10878469	BRG,FC7Y-45,INA, FOR CRANE DRIVE, FLANGE	N			4	EA
<input checked="" type="checkbox"/>	10878624	CHAIN,ROLLER,SIMPLEX,1"-16B,DIN-S188	N			2	EA
<input checked="" type="checkbox"/>	10878626	ROPE,WIRE,18 MM DIA,58.7M LG,FLEXPACK	N			1	EA
<input checked="" type="checkbox"/>	13734421	FRAME,LIFTING,SWL 8TON,9000x200x600	N			1	EA
<input checked="" type="checkbox"/>	10555942	CRANE, OVERHEAD	00.00.0000	U133M			000005140947
<input checked="" type="checkbox"/>	BD/EKOM/19 07558	FADEYE TEST SWL 35T (FOR OT CRANE )	U133M				
<input checked="" type="checkbox"/>	11786494	FADEYE, TEST SWL 35T (FOR OT CRANE )	00.00.0000	U133M			000018599794
<input checked="" type="checkbox"/>	BD/EKOM/27 23857	HEATER ELEMENT MOTOR 30 07012	U133M				
<input checked="" type="checkbox"/>	13247351	ELEM,HEAT,230 V,60 HZ,26 W,CEMP	N			1	EA
<input checked="" type="checkbox"/>	BD/EKOM/27 23858	HEATER ELEMENT MOTOR 30 07258	U133M				
<input checked="" type="checkbox"/>	13247351	ELEM,HEAT,230 V,60 HZ,26 W,CEMP	N			1	EA
<input checked="" type="checkbox"/>	BD/EKOM/28 07010	SWITCH MAIN FOR OVERHEAD CRANE 19 07010	U133M				
<input checked="" type="checkbox"/>	BD/EKOM/28 07011	SWITCH PUSH BUTTON STATION FOR 19 07010	U133M				
<input checked="" type="checkbox"/>	10878623	STATION,CNTL,FNDNT,XBW 5AS142,TELEMEC	N			1	EA
<input checked="" type="checkbox"/>	BD/EKOM/28 08293	SWITCH EMERG STOP CRANE 19 07010	U133M				
<input checked="" type="checkbox"/>	10356809	BUTTON,CEAG,GHG-4118100-R0002,EMERGENCY	N			1	EA
<input checked="" type="checkbox"/>	BD/EKOM/28 JB-08238	JUNCTION BOX	U133M				
<input checked="" type="checkbox"/>	BD/EKOM/28 JE-07010	BOX JUNCTION OVERHEAD CRANE 19 07010	U133M				
<input checked="" type="checkbox"/>	BD/EKOM/28 LCP-07010	PANEL CONTROL. OVERHEAD CRANE 19 07010	U133M				
<input checked="" type="checkbox"/>	10878953	PANEL,CNTL,TNCD575727+TNCN573827,DREGGEN	N			1	EA
<input checked="" type="checkbox"/>	10488332	TIMER,ON DELAY,LA4-DT2U,TELEMECANIQUE	N			1	EA
<input checked="" type="checkbox"/>	10870600	CONTACTOR,LC1-D09U7,TELEMECANIQUE	N			5	EA
<input checked="" type="checkbox"/>	10878372	CONTACTOR,LC1-D32P7,TELEMECANIQUE	N			5	EA
<input checked="" type="checkbox"/>	10878373	RELAY,CONTROL,CAD-32P7,TELEMECANIQUE	N			5	EA
<input checked="" type="checkbox"/>	10878374	BLK,CONT,LAD-T2,TELEMECANIQUE,TIME DELAY	N			1	EA
<input checked="" type="checkbox"/>	10878375	RELAY,THERM,LT3-SAD0M,TELEMECANIQUE	N			3	EA
<input checked="" type="checkbox"/>	10878379	CONVERTER,KFA6-SR2-EX2.W,PEPPERL+FUCHS	N			4	EA
<input checked="" type="checkbox"/>	11461278	BREAKER,CIRC,24 - 32 A,GV2ME32	N			1	EA

☑	BD/EKOM/30 07010	MOTOR HOIST. CRANE OVERHEAD	19 07010	U133M		
☑	☑	10556121	MOTOR, ELECTRICAL	00.00.0000	U133M	000005141126
☑	☑	☑	10878853	MOTOR, ELECT, PB25-200-LB-4/12, CEMP	N	1 EA
☑	☑	☑	10623297	BEARING, BALL, 6212-22-C3, SKF	N	2 EA
☑	☑	☑	10878464	BRAKE, ASSY, PY-3C, CEMP, FOR EL MOTOR	N	1 EA
☑	☑	☑	10878853	MOTOR, ELECT, PB25-200-LB-4/12, CEMP	N	1 EA
☑	☑	☑	10623297	BEARING, BALL, 6212-22-C3, SKF	N	2 EA
☑	☑	☑	10878464	BRAKE, ASSY, PY-3C, CEMP, FOR EL MOTOR	N	1 EA
☑	BD/EKOM/30 07011	MOTOR TROLLEY. CRANE OVERHEAD	19 07010	U133M		
☑	☑	☑	10556125	MOTOR, ELECTRICAL	00.00.0000	U133M 000005141130
☑	☑	☑	10878859	MOTOR, ELECT, DB35-90-L-4, CEMP, 690V, 60HZ	N	1 EA
☑	☑	☑	10000998	BEARING, BALL, RADIAL, 6205-2Z, SKF	N	2 EA
☑	☑	☑	10878755	BRAKE, ASSY, MEC-80, CEMP, FOR EL MOTOR	N	1 EA
☑	☑	☑	10878859	MOTOR, ELECT, DB35-90-L-4, CEMP, 690V, 60HZ	N	1 EA
☑	☑	☑	10000998	BEARING, BALL, RADIAL, 6205-2Z, SKF	N	2 EA
☑	☑	☑	10878755	BRAKE, ASSY, MEC-80, CEMP, FOR EL MOTOR	N	1 EA
☑	BD/EKOM/30 07012	MOTOR TRAVEL E. CRANE OVERHEAD.	19 07010	U133M		
☑	☑	☑	11858589	MOTOR, ELECTRICAL	00.00.0000	U133M 000020289512
☑	☑	☑	13238542	MOTOR, ELECT, HB35100LA4B53RF690S/60 2.2KW N	N	1 EA
☑	BD/EKOM/30 07258	MOTOR TRAVEL W. CRANE OVERHEAD.	19 07010	U133M		
☑	☑	☑	11858578	MOTOR, ELECTRICAL	00.00.0000	U133M 000020289134
☑	☑	☑	13238542	MOTOR, ELECT, HB35100LA4B53RF690S/60 2.2KW N	N	1 EA
☑	BD/EKOM/43 JB-03961	JB OVERRIDE SWITCH ANTI COLL.	19-07010	U133M		
☑	☑	☑	13215739	SWITCH, OVERRIDE, 5012590, MUNCK CRANES	N	1 EA
☑	BD/EKOM/43 JB-03971	JUNCTION BOX EX ANTI COLLISION	19-07010	U133M		
☑	☑	☑	13215738	BOX, JUNCTION, 5012589, MUNCK CRANES	N	1 EA
☑	BD/EKOM/43 TY-07012	ELEM TEMP CONVERSION FOR MOTOR 30 07012	U133M			
☑	☑	☑	11437355	RELAY, MOTOR PROT, LT3 SE00M, TELEMECANIQUE	N	1 EA
☑	BD/EKOM/43 TY-07258	ELEM TEMPE CONVERSION FOR MOTOR 30 07258	U133M			
☑	☑	☑	11437355	RELAY, MOTOR PROT, LT3 SE00M, TELEMECANIQUE	N	1 EA
☑	BD/EKOM/43 ZE-29556	ELEMENT POSITION REFLECTOR "A"	19 07010	U133M		
☑	☑	☑	13238391	REFLECTOR, 100X100MM, E39-R8, OMRON	N	1 EA

<input checked="" type="checkbox"/>	<input checked="" type="checkbox"/>	BD/EKOM/43 ZE-29557	ELEMENT POSITION REFLECTOR "B" 19 07010	U133M		
	<input checked="" type="checkbox"/>	13238391	REFLECTOR, 100X100MM, E39-R8, OMRON	N	1	EA
<input checked="" type="checkbox"/>	<input checked="" type="checkbox"/>	BD/EKOM/43 ZS-01850	SW LIMIT HOOK POS OVERH CRANE 19 07010	U133M		
<input checked="" type="checkbox"/>	<input checked="" type="checkbox"/>	BD/EKOM/43 ZS-01852	SWITCH POS TROLLY OVERH CRANE 19 07010	U133M		
	<input checked="" type="checkbox"/>	10878336	SWITCH, PROX, NJ20+U1+N, PEPPERL & FUCHS		1	EA
<input checked="" type="checkbox"/>	<input checked="" type="checkbox"/>	BD/EKOM/43 ZS-01853	SWITCH POS TROLLY OVERH CRANE 19 07010	U133M		
	<input checked="" type="checkbox"/>	10878336	SWITCH, PROX, NJ20+U1+N, PEPPERL & FUCHS		1	EA
<input checked="" type="checkbox"/>	<input checked="" type="checkbox"/>	BD/EKOM/43 ZS-01854	SWITCH POS TRAVEL OVERH CRANE 19 07010	U133M		
	<input checked="" type="checkbox"/>	10878336	SWITCH, PROX, NJ20+U1+N, PEPPERL & FUCHS		1	EA
<input checked="" type="checkbox"/>	<input checked="" type="checkbox"/>	BD/EKOM/43 ZS-01855	SWITCH POS TRAVEL OVERH CRANE 19 07010	U133M		
	<input checked="" type="checkbox"/>	10878336	SWITCH, PROX, NJ20+U1+N, PEPPERL & FUCHS		1	EA
<input checked="" type="checkbox"/>	<input checked="" type="checkbox"/>	BD/EKOM/43 ZS-29173	SWITCH LIMIT LASER 19 07010	U133M		
	<input checked="" type="checkbox"/>	13215645	UNIT, LASER, W/ENCLOSURE, 5012423, MUNCK	N	1	EA
<input checked="" type="checkbox"/>	<input checked="" type="checkbox"/>	BD/EKOM/43 ZS-29174	SWITCH LIMIT LASER 19 07010	U133M		
	<input checked="" type="checkbox"/>	13215645	UNIT, LASER, W/ENCLOSURE, 5012423, MUNCK	N	1	EA
<input checked="" type="checkbox"/>	<input checked="" type="checkbox"/>	BD/EKOM/63 07055	GEARBOX. MOTOR TRAVELLING 30 07258	U133M		
	<input checked="" type="checkbox"/>	11859757	GEARBOX	00.00.0000	U133M	000020356379
	<input checked="" type="checkbox"/>	13238543	GEAR, KU 80/AIAKAD100, I=62.9, WATT DRIVE	N	1	EA
<input checked="" type="checkbox"/>	<input checked="" type="checkbox"/>	BD/EKOM/63 07056	GEARBOX. MOTOR TRAVELLING 30 07012	U133M		
	<input checked="" type="checkbox"/>	11859758	GEARBOX	00.00.0000	U133M	000020356380
	<input checked="" type="checkbox"/>	13238543	GEAR, KU 80/AIAKAD100, I=62.9, WATT DRIVE	N	1	EA

### C.2 TAG No. 07015

Functional loc.	BD/EKOM/840/19 07015	Description	SKID CRANE OVERHEAD TRAVELLING 25 T	Valid From	05.03.18			
<input checked="" type="checkbox"/>	BD/EKOM/840/19 07015	SKID CRANE OVERHEAD TRAVELLING 25 T				U133M		
<input checked="" type="checkbox"/>	BD/EKOM/19 02821	BLOCK DOUBLE SHEAVE WITH HOOK				U133M		
<input checked="" type="checkbox"/>	BD/EKOM/19 02822	WIRE 18 MM MIN BRUDD 32,9 T				U133M		
<input checked="" type="checkbox"/>	10878626	ROPE, WIRE, 18 MM DIA, 58.7M LG, FLEXPACK	N			1	EA	
<input checked="" type="checkbox"/>	BD/EKOM/19 07015	CRANE OVERHEAD TRAVELLING 25 T SOUTH				U133M		
<input checked="" type="checkbox"/>	10878336	SWITCH, PROX, NJ20+U1+N, PEPPERL & FUCHS	N			4	EA	
<input checked="" type="checkbox"/>	10878370	SW, LIMIT, ZS-336-11Z, SCHMERSAL, 4A/230VAC	N			1	EA	
<input checked="" type="checkbox"/>	10878371	SWITCH, LIMIT, 125BM-499.B5, STROMAG	N			1	EA	
<input checked="" type="checkbox"/>	10878298	CHAIN, DRAG, 200.12.150, ASI AUTOMATIKK	N			1	EA	
<input checked="" type="checkbox"/>	10878299	CHAIN, DRAG, 26.20.150.0, ASI AUTOMATIKK	N			1	EA	
<input checked="" type="checkbox"/>	10878623	STATION, CNIL, FNDNT, XBW 5AS142, TELEMEC	N			1	EA	
<input checked="" type="checkbox"/>	10878466	BRG, RASEY-45, INA, FOR CRANE DRIVE, FOOT	N			17	EA	
<input checked="" type="checkbox"/>	10878469	BRG, PCJY-45, INA, FOR CRANE DRIVE, FLANGE	N			4	EA	
<input checked="" type="checkbox"/>	10878624	CHAIN, ROLLER, SIMPLEX, 1"-16B, DIN-8188	N			2	EA	
<input checked="" type="checkbox"/>	10878626	ROPE, WIRE, 18 MM DIA, 58.7M LG, FLEXPACK	N			1	EA	
<input checked="" type="checkbox"/>	13734421	FRAME, LIFTING, SWL 8TON, 9000x200x600	N			1	EA	
<input checked="" type="checkbox"/>	10555946	CRANE, OVERHEAD		00.00.0000		U133M		000005140951
<input checked="" type="checkbox"/>	BD/EKOM/27 23859	HEATER ELEMENT MOTOR 30 07017				U133M		
<input checked="" type="checkbox"/>	13247351	ELEM, HEAT, 230 V, 60 HZ, 26 W, CEMP	N			1	EA	
<input checked="" type="checkbox"/>	BD/EKOM/27 23860	HEATER ELEMENT MOTOR 30 07259				U133M		
<input checked="" type="checkbox"/>	13247351	ELEM, HEAT, 230 V, 60 HZ, 26 W, CEMP	N			1	EA	
<input checked="" type="checkbox"/>	BD/EKOM/28 07015	SWITCH MAIN FOR OVERHEAD CRANE 19 07015				U133M		
<input checked="" type="checkbox"/>	BD/EKOM/28 07016	SWITCH PUSH BUTTON STATION FOR 19 07015				U133M		
<input checked="" type="checkbox"/>	10878623	STATION, CNIL, FNDNT, XBW 5AS142, TELEMEC	N			1	EA	
<input checked="" type="checkbox"/>	BD/EKOM/28 08294	SWITCH EMERG STOP CRANE 19 07015				U133M		
<input checked="" type="checkbox"/>	10356809	BUTTON, CEAG, GHG-4118100-R0002, EMERGENCY	N			1	EA	
<input checked="" type="checkbox"/>	BD/EKOM/28 JE-07015	BOX JUNCTION. OVERHEAD CRANE 19 07015				U133M		
<input checked="" type="checkbox"/>	BD/EKOM/28 LCP-07015	PANEL CONTROL OVERHEAD CRANE 19 07015				U133M		
<input checked="" type="checkbox"/>	10878953	PANEL, CNIL, INCD575727+INCN573827, DREGGEN	N			1	EA	
<input checked="" type="checkbox"/>	10488932	TIMER, ON DELAY, LA4-DT20, TELEMECANIQUE	N			1	EA	
<input checked="" type="checkbox"/>	10870600	CONTACTOR, LC1-D09U7, TELEMECANIQUE	N			5	EA	
<input checked="" type="checkbox"/>	10878372	CONTACTOR, LC1-D32P7, TELEMECANIQUE	N			5	EA	
<input checked="" type="checkbox"/>	10878373	RELAY, CONTROL, CAD-32P7, TELEMECANIQUE	N			5	EA	
<input checked="" type="checkbox"/>	10878374	BLK, CONT, LAD-T2, TELEMECANIQUE, TIME DELAY	N			1	EA	
<input checked="" type="checkbox"/>	10878375	RELAY, THERM, LTS-SA00M, TELEMECANIQUE	N			3	EA	
<input checked="" type="checkbox"/>	10878379	CONVERTER, KFA6-SR2-EX2.W, PEPPERL+FUCHS	N			4	EA	
<input checked="" type="checkbox"/>	11461278	BREAKER, CIRC, 24 - 32 A, GV2ME32	N			1	EA	
<input checked="" type="checkbox"/>	BD/EKOM/30 07015	MOTOR HOIST. CRANE OVERHEAD 19 07015				U133M		
<input checked="" type="checkbox"/>	10556124	MOTOR, ELECTRICAL		00.00.0000		U133M		000005141129
<input checked="" type="checkbox"/>	10878853	MOTOR, ELECT, PB25-200-LB-4/12, CEMP	N			1	EA	

<input checked="" type="checkbox"/>	<input checked="" type="checkbox"/>	<input type="checkbox"/>	10623297	BEARING,BALL,6212-22-C3,SKF	N		2	EA
<input checked="" type="checkbox"/>	<input checked="" type="checkbox"/>	<input type="checkbox"/>	10878464	BRAKE,ASSY,PY-3C,CEMP,FOR EL MOTOR	N		1	EA
<input checked="" type="checkbox"/>	<input checked="" type="checkbox"/>	<input checked="" type="checkbox"/>	10878853	MOTOR,ELECT,PR25-200-LB-4/12,CEMP			1	EA
<input checked="" type="checkbox"/>	<input checked="" type="checkbox"/>	<input type="checkbox"/>	10623297	BEARING,BALL,6212-22-C3,SKF	N		2	EA
<input checked="" type="checkbox"/>	<input checked="" type="checkbox"/>	<input type="checkbox"/>	10878464	BRAKE,ASSY,PY-3C,CEMP,FOR EL MOTOR	N		1	EA
<input checked="" type="checkbox"/>	<input checked="" type="checkbox"/>	<input checked="" type="checkbox"/>	BD/EKOM/30 07016	MOTOR TROLLY. CRANE OVERHEAD 19 07015 U133M				
<input checked="" type="checkbox"/>	<input checked="" type="checkbox"/>	<input checked="" type="checkbox"/>	10556122	MOTOR, ELECTRICAL		00.00.0000	U133M	000005141127
<input checked="" type="checkbox"/>	<input checked="" type="checkbox"/>	<input checked="" type="checkbox"/>	10878859	MOTOR,ELECT,DB35-90-L-4,CEMP,690V,60HZ	N		1	EA
<input checked="" type="checkbox"/>	<input checked="" type="checkbox"/>	<input type="checkbox"/>	10000998	BEARING,BALL,RADIAL,6205-22,SKF	N		2	EA
<input checked="" type="checkbox"/>	<input checked="" type="checkbox"/>	<input type="checkbox"/>	10878755	BRAKE,ASSY,MEC-80,CEMP,FOR EL MOTOR	N		1	EA
<input checked="" type="checkbox"/>	<input checked="" type="checkbox"/>	<input checked="" type="checkbox"/>	10878859	MOTOR,ELECT,DB35-90-L-4,CEMP,690V,60HZ			1	EA
<input checked="" type="checkbox"/>	<input checked="" type="checkbox"/>	<input type="checkbox"/>	10000998	BEARING,BALL,RADIAL,6205-22,SKF	N		2	EA
<input checked="" type="checkbox"/>	<input checked="" type="checkbox"/>	<input type="checkbox"/>	10878755	BRAKE,ASSY,MEC-80,CEMP,FOR EL MOTOR	N		1	EA
<input checked="" type="checkbox"/>	<input checked="" type="checkbox"/>	<input checked="" type="checkbox"/>	BD/EKOM/30 07017	MOTOR TRAVEL WEST. CRANE OVERH. 19 07015 U133M				
<input checked="" type="checkbox"/>	<input checked="" type="checkbox"/>	<input checked="" type="checkbox"/>	11858590	MOTOR, ELECTRICAL		00.00.0000	U133M	000020289546
<input checked="" type="checkbox"/>	<input checked="" type="checkbox"/>	<input checked="" type="checkbox"/>	13238542	MOTOR,ELECT,HB35100LA4B53RF690S/60 2.2KW	N		1	EA
<input checked="" type="checkbox"/>	<input checked="" type="checkbox"/>	<input checked="" type="checkbox"/>	BD/EKOM/30 07259	MOTOR TRAVEL EAST. CRANE OVERH. 19 07015 U133M				
<input checked="" type="checkbox"/>	<input checked="" type="checkbox"/>	<input checked="" type="checkbox"/>	11858579	MOTOR, ELECTRICAL		00.00.0000	U133M	000020289142
<input checked="" type="checkbox"/>	<input checked="" type="checkbox"/>	<input checked="" type="checkbox"/>	13238542	MOTOR,ELECT,HB35100LA4B53RF690S/60 2.2KW	N		1	EA
<input checked="" type="checkbox"/>	<input checked="" type="checkbox"/>	<input checked="" type="checkbox"/>	BD/EKOM/43 JB-03962	JB. OVERRIDE SWITCH ANTI COLL. 19-07015 U133M				
<input checked="" type="checkbox"/>	<input checked="" type="checkbox"/>	<input checked="" type="checkbox"/>	13215739	SWITCH, OVERRIDE, 5012590, MUNCK CRANES	N		1	EA
<input checked="" type="checkbox"/>	<input checked="" type="checkbox"/>	<input checked="" type="checkbox"/>	BD/EKOM/43 JB-03972	JUNCTION BOX EX ANTI COLLISION 19-07015 U133M				
<input checked="" type="checkbox"/>	<input checked="" type="checkbox"/>	<input checked="" type="checkbox"/>	13215738	BOX, JUNCTION, 5012589, MUNCK CRANES	N		1	EA
<input checked="" type="checkbox"/>	<input checked="" type="checkbox"/>	<input checked="" type="checkbox"/>	BD/EKOM/43 TY-07017	ELEM TEMP CONVERSION FOR MOTOR 30 07017 U133M				
<input checked="" type="checkbox"/>	<input checked="" type="checkbox"/>	<input checked="" type="checkbox"/>	11437355	RELAY,MOTOR PROT,LT3 SE00M,TELEMECANIQUE	N		1	EA
<input checked="" type="checkbox"/>	<input checked="" type="checkbox"/>	<input checked="" type="checkbox"/>	BD/EKOM/43 TY-07259	ELEM TEMP CONVERSION FOR MOTOR 30 07259 U133M				
<input checked="" type="checkbox"/>	<input checked="" type="checkbox"/>	<input checked="" type="checkbox"/>	11437355	RELAY,MOTOR PROT,LT3 SE00M,TELEMECANIQUE	N		1	EA
<input checked="" type="checkbox"/>	<input checked="" type="checkbox"/>	<input checked="" type="checkbox"/>	BD/EKOM/43 ZE-29558	ELEMENT POSITION REFLECTOR "A" 19 07015 U133M				
<input checked="" type="checkbox"/>	<input checked="" type="checkbox"/>	<input checked="" type="checkbox"/>	13238391	REFLECTOR,100X100MM,E39-R8,OMRON	N		1	EA
<input checked="" type="checkbox"/>	<input checked="" type="checkbox"/>	<input checked="" type="checkbox"/>	BD/EKOM/43 ZE-29559	ELEMENT POSITION REFLECTOR "B" 19 07015 U133M				
<input checked="" type="checkbox"/>	<input checked="" type="checkbox"/>	<input checked="" type="checkbox"/>	13238391	REFLECTOR,100X100MM,E39-R8,OMRON	N		1	EA

<input checked="" type="checkbox"/>	BD/EKOM/43 ZS-01856	SWITCH POS HOOK POS OVERH CRANE 19 07015	U133M		
<input checked="" type="checkbox"/>	BD/EKOM/43 ZS-01858	SWITCH POS TROLLY OVERH CRANE 19 07015	U133M		
<input checked="" type="checkbox"/>	10878336	SWITCH, PROX, NJ20+U1+N, PEPPERL & FUCHS		1	EA
<input checked="" type="checkbox"/>	BD/EKOM/43 ZS-01859	SWITCH POS TROLLY OVERH CRANE 19 07015	U133M		
<input checked="" type="checkbox"/>	10878336	SWITCH, PROX, NJ20+U1+N, PEPPERL & FUCHS		1	EA
<input checked="" type="checkbox"/>	BD/EKOM/43 ZS-01860	SWITCH POS TRAVEL OVERH CRANE 19 07015	U133M		
<input checked="" type="checkbox"/>	10878336	SWITCH, PROX, NJ20+U1+N, PEPPERL & FUCHS		1	EA
<input checked="" type="checkbox"/>	BD/EKOM/43 ZS-01861	SWITCH POS TRAVEL OVERH CRANE 19 07015	U133M		
<input checked="" type="checkbox"/>	10878336	SWITCH, PROX, NJ20+U1+N, PEPPERL & FUCHS		1	EA
<input checked="" type="checkbox"/>	BD/EKOM/43 ZS-29171	SWITCH LIMIT LASER 19 07015	U133M		
<input checked="" type="checkbox"/>	13215645	UNIT, LASER, W/ENCLOSURE, 5012423, MUNCK	N	1	EA
<input checked="" type="checkbox"/>	BD/EKOM/43 ZS-29172	SWITCH LIMIT LASER 19 07015	U133M		
<input checked="" type="checkbox"/>	13215645	UNIT, LASER, W/ENCLOSURE, 5012423, MUNCK	N	1	EA
<input checked="" type="checkbox"/>	BD/EKOM/63 07057	GEARBOX DRIVE MOTOR 30 07017	U133M		
<input checked="" type="checkbox"/>	11859759	GEARBOX	00.00.0000	U133M	000020356381
<input checked="" type="checkbox"/>	13238543	GEAR, KU 80/AIAKAD100, I=62.9, WAIT DRIVE	N	1	EA
<input checked="" type="checkbox"/>	BD/EKOM/63 07058	GEARBOX DRIVE MOTOR 30 07259	U133M		
<input checked="" type="checkbox"/>	11859760	GEARBOX	00.00.0000	U133M	000020356382
<input checked="" type="checkbox"/>	13238543	GEAR, KU 80/AIAKAD100, I=62.9, WAIT DRIVE	N	1	EA



### C.3 TAG No. 07020

Functional loc.	BD/EKOM/840/19 07020	Description	SKID CRANE OVERHEAD TRAVELLING 15 T	Valid From	05.03.18			
<input checked="" type="checkbox"/>	BD/EKOM/840/19 07020	SKID CRANE OVERHEAD TRAVELLING 15 T				U133M		
<input checked="" type="checkbox"/>	BD/EKOM/19 02817	BLOCK DOUBLE SHEAVE WITH HOOK				U133M		
<input checked="" type="checkbox"/>	BD/EKOM/19 02818	WIRE 14 MM MIN BRUDD 20T				U133M		
<input checked="" type="checkbox"/>	10878627	ROPE, WIRE, 14 MM DIA, 44M LG, 35WX7	N			1	EA	
<input checked="" type="checkbox"/>	BD/EKOM/19 07020	CRANE OVERHEAD TRAVELLING 15 T NORTH				U133M		
<input checked="" type="checkbox"/>	10878872	CRANE, OVERHD TRAVL, 15T, DREGGEN, ELECT	N			1	EA	
<input checked="" type="checkbox"/>	10878298	CHAIN, DRAG, 200.12.150, ASI AUTOMATIKK	N			1	EA	
<input checked="" type="checkbox"/>	10878336	SWITCH, PROX, NJ20+U1+N, PEPPERL & FUCHS	N			6	EA	
<input checked="" type="checkbox"/>	10878370	SW, LIMIT, 2S-336-11Z, SCHMERSAL, 4A/230VAC	N			1	EA	
<input checked="" type="checkbox"/>	10878460	TROLLEY, CABLE CARRIER, WST-1-F/85E, VAHLE	N			10	EA	
<input checked="" type="checkbox"/>	10878461	TROLLEY, CABLE CARRIER, MST-1-F/85E, VAHLE	N			1	EA	
<input checked="" type="checkbox"/>	10878623	STATION, CNTL, PNDNT, XBW 5AS142, TELEMEC	N			1	EA	
<input checked="" type="checkbox"/>	10878627	ROPE, WIRE, 14 MM DIA, 44M LG, 35WX7	N			1	EA	
<input checked="" type="checkbox"/>	10555951	CRANE, OVERHEAD		00.00.0000		U133M		000005140956
<input checked="" type="checkbox"/>	BD/EKOM/19 07559	PADEYE TEST SWL 25T (FOR OT CRANE)				U133M		
<input checked="" type="checkbox"/>	11786495	PADEYE, TEST SWL 25T (FOR OT CRANE)		00.00.0000		U133M		000018599801
<input checked="" type="checkbox"/>	BD/EKOM/28 07020	SWITCH MAIN FOR OVERHEAD CRANE 19 07020				U133M		
<input checked="" type="checkbox"/>	BD/EKOM/28 07021	SWITCH PUSH BUTION STATION FOR 19 07020				U133M		
<input checked="" type="checkbox"/>	10878623	STATION, CNTL, PNDNT, XBW 5AS142, TELEMEC				1	EA	
<input checked="" type="checkbox"/>	BD/EKOM/28 08295	SWITCH EMERG STOP CRANE 19 07020				U133M		
<input checked="" type="checkbox"/>	10356809	BUTTON, CEAG, GHG-4118100-R0002, EMERGENCY	N			1	EA	
<input checked="" type="checkbox"/>	BD/EKOM/28 JE-07020	BOX JUNCTION TRAVELLING CRANE 19 07020				U133M		
<input checked="" type="checkbox"/>	BD/EKOM/28 JE-07021	BOX JUNCTION TRAVELLING CRANE 19 07020				U133M		
<input checked="" type="checkbox"/>	BD/EKOM/28 LCP-07020	PANEL CONTROL TRAVELLING CRANE 19 07020				U133M		
<input checked="" type="checkbox"/>	10878953	PANEL, CNTL, TNCD575727+TNCN573827, DREGGEN	N			1	EA	
<input checked="" type="checkbox"/>	10488332	TIMER, ON DELAY, LA4-DT2U, TELEMECANIQUE	N			1	EA	
<input checked="" type="checkbox"/>	10870600	CONTACTOR, LC1-D09U7, TELEMECANIQUE	N			5	EA	
<input checked="" type="checkbox"/>	10878372	CONTACTOR, LC1-D32P7, TELEMECANIQUE	N			5	EA	
<input checked="" type="checkbox"/>	10878373	RELAY, CONTROL, CAD-32P7, TELEMECANIQUE	N			5	EA	
<input checked="" type="checkbox"/>	10878374	BLK, CONT, LAD-T2, TELEMECANIQUE, TIME DELAY	N			1	EA	
<input checked="" type="checkbox"/>	10878375	RELAY, THERM, LT3-SA00M, TELEMECANIQUE	N			3	EA	
<input checked="" type="checkbox"/>	10878379	CONVERTER, KFA6-SR2-EX2.W, PEPPERL+FUCHS	N			4	EA	
<input checked="" type="checkbox"/>	10472432	PCS-MCCR All Elektro				1	EA	
<input checked="" type="checkbox"/>	BD/EKOM/30 07020	MOTOR HOIST. CRANE OVERHEAD 19 07020				U133M		
<input checked="" type="checkbox"/>	10556127	MOTOR, ELECTRICAL		00.00.0000		U133M		000005141132
<input checked="" type="checkbox"/>	10878853	MOTOR, ELECT, PB25-200-LB-4/12, CEMP	N			1	EA	
<input checked="" type="checkbox"/>	10623297	BEARING, BALL, 6212-2Z-C3, SKF	N			2	EA	
<input checked="" type="checkbox"/>	10878464	BRAKE, ASSY, PY-3C, CEMP, FOR EL MOTOR	N			1	EA	
<input checked="" type="checkbox"/>	10878853	MOTOR, ELECT, PB25-200-LB-4/12, CEMP				1	EA	

<input checked="" type="checkbox"/>	<input type="checkbox"/>	10623297	BEARING,BALL,6212-2Z-C3,SKF	N	2	EA	
<input checked="" type="checkbox"/>	<input type="checkbox"/>	10878464	BRAKE,ASSY,PY-3C,CEMP,FOR EL MOTOR	N	1	EA	
<input checked="" type="checkbox"/>	<input checked="" type="checkbox"/>	BD/EKOM/30 07021 MOTOR TROLLEY. CRANE OVERHEAD 19 07020 U133M					
<input checked="" type="checkbox"/>	<input checked="" type="checkbox"/>	10556128	MOTOR, ELECTRICAL	00.00.0000	U133M	000005141133	
<input checked="" type="checkbox"/>	<input checked="" type="checkbox"/>	10878858	MOTOR,ELECT,DB35-90-S-4,CEMP,690V,60HZ	N	1	EA	
<input checked="" type="checkbox"/>	<input checked="" type="checkbox"/>	10000998	BEARING,BALL,RADIAL,6205-2Z,SKF	N	2	EA	
<input checked="" type="checkbox"/>	<input checked="" type="checkbox"/>	10878755	BRAKE,ASSY,MEC-80,CEMP,FOR EL MOTOR	N	1	EA	
<input checked="" type="checkbox"/>	<input checked="" type="checkbox"/>	10878858	MOTOR,ELECT,DB35-90-S-4,CEMP,690V,60HZ		1	EA	
<input checked="" type="checkbox"/>	<input checked="" type="checkbox"/>	10000998	BEARING,BALL,RADIAL,6205-2Z,SKF	N	2	EA	
<input checked="" type="checkbox"/>	<input checked="" type="checkbox"/>	10878755	BRAKE,ASSY,MEC-80,CEMP,FOR EL MOTOR	N	1	EA	
<input checked="" type="checkbox"/>	<input checked="" type="checkbox"/>	BD/EKOM/30 07022 MOTOR TRAVELLING.CRANE OVERHEAD 19 07020 U133M					
<input checked="" type="checkbox"/>	<input checked="" type="checkbox"/>	10556129	MOTOR, ELECTRICAL	00.00.0000	U133M	000005141134	
<input checked="" type="checkbox"/>	<input checked="" type="checkbox"/>	10878858	MOTOR,ELECT,DB35-90-S-4,CEMP,690V,60HZ	N	1	EA	
<input checked="" type="checkbox"/>	<input checked="" type="checkbox"/>	10000998	BEARING,BALL,RADIAL,6205-2Z,SKF	N	2	EA	
<input checked="" type="checkbox"/>	<input checked="" type="checkbox"/>	10878755	BRAKE,ASSY,MEC-80,CEMP,FOR EL MOTOR	N	1	EA	
<input checked="" type="checkbox"/>	<input checked="" type="checkbox"/>	10878858	MOTOR,ELECT,DB35-90-S-4,CEMP,690V,60HZ		1	EA	
<input checked="" type="checkbox"/>	<input checked="" type="checkbox"/>	10000998	BEARING,BALL,RADIAL,6205-2Z,SKF	N	2	EA	
<input checked="" type="checkbox"/>	<input checked="" type="checkbox"/>	10878755	BRAKE,ASSY,MEC-80,CEMP,FOR EL MOTOR	N	1	EA	
<input checked="" type="checkbox"/>	<input checked="" type="checkbox"/>	BD/EKOM/30 07023 MOTOR TRAVELLING.CRANE OVERHEAD 19 07020 U133M					
<input checked="" type="checkbox"/>	<input checked="" type="checkbox"/>	10556130	MOTOR, ELECTRICAL	00.00.0000	U133M	000005141135	
<input checked="" type="checkbox"/>	<input checked="" type="checkbox"/>	10878858	MOTOR,ELECT,DB35-90-S-4,CEMP,690V,60HZ	N	1	EA	
<input checked="" type="checkbox"/>	<input checked="" type="checkbox"/>	10000998	BEARING,BALL,RADIAL,6205-2Z,SKF	N	2	EA	
<input checked="" type="checkbox"/>	<input checked="" type="checkbox"/>	10878755	BRAKE,ASSY,MEC-80,CEMP,FOR EL MOTOR	N	1	EA	
<input checked="" type="checkbox"/>	<input checked="" type="checkbox"/>	10878858	MOTOR,ELECT,DB35-90-S-4,CEMP,690V,60HZ		1	EA	
<input checked="" type="checkbox"/>	<input checked="" type="checkbox"/>	10000998	BEARING,BALL,RADIAL,6205-2Z,SKF	N	2	EA	
<input checked="" type="checkbox"/>	<input checked="" type="checkbox"/>	10878755	BRAKE,ASSY,MEC-80,CEMP,FOR EL MOTOR	N	1	EA	
<input checked="" type="checkbox"/>	<input checked="" type="checkbox"/>	BD/EKOM/43 ZS-01862 SWITCH POS HOOK TOP OVERH CRANE 19 07020 U133M					
<input checked="" type="checkbox"/>	<input checked="" type="checkbox"/>	10878336	SWITCH,PROX,NJ20+U1+N,PEPPERL & FUCHS		1	EA	
<input checked="" type="checkbox"/>	<input checked="" type="checkbox"/>	BD/EKOM/43 ZS-01863 SWITCH POS HOOK BOTI OVERH CRN 19 07020 U133M					
<input checked="" type="checkbox"/>	<input checked="" type="checkbox"/>	10878336	SWITCH,PROX,NJ20+U1+N,PEPPERL & FUCHS		1	EA	
<input checked="" type="checkbox"/>	<input checked="" type="checkbox"/>	BD/EKOM/43 ZS-01864 SWITCH POS TROLLY OVERH CRANE 19 07020 U133M					
<input checked="" type="checkbox"/>	<input checked="" type="checkbox"/>	10878336	SWITCH,PROX,NJ20+U1+N,PEPPERL & FUCHS		1	EA	
<input checked="" type="checkbox"/>	<input checked="" type="checkbox"/>	BD/EKOM/43 ZS-01865 SWITCH POS TROLLY OVERH CRANE 19 07020 U133M					
<input checked="" type="checkbox"/>	<input checked="" type="checkbox"/>	10878336	SWITCH,PROX,NJ20+U1+N,PEPPERL & FUCHS		1	EA	
<input checked="" type="checkbox"/>	<input checked="" type="checkbox"/>	BD/EKOM/43 ZS-01866 SWITCH POS TRAVEL OVERH CRANE 19 07020 U133M					
<input checked="" type="checkbox"/>	<input checked="" type="checkbox"/>	10878336	SWITCH,PROX,NJ20+U1+N,PEPPERL & FUCHS		1	EA	
<input checked="" type="checkbox"/>	<input checked="" type="checkbox"/>	BD/EKOM/43 ZS-01867 SWITCH POS TRAVEL OVERH CRANE 19 07020 U133M					
<input checked="" type="checkbox"/>	<input checked="" type="checkbox"/>	10878336	SWITCH,PROX,NJ20+U1+N,PEPPERL & FUCHS		1	EA	

## C.4 TAG No. 07025

Functional loc.	BD/EKOM/840/19 07025	Valid From	05.03.18
Description	SKID CRANE OVERHEAD TRAVELLING 15 T		
<input checked="" type="checkbox"/>	BD/EKOM/840/19 07025	SKID CRANE OVERHEAD TRAVELLING 15 T	U133M
<input checked="" type="checkbox"/>	<input checked="" type="checkbox"/> BD/EKOM/19 02819	BLOCK DOUBLE SHEAVE WITH HOOK	U133M
<input checked="" type="checkbox"/>	<input checked="" type="checkbox"/> BD/EKOM/19 02820	WIRE 14 MM MIN BRUDD 20T	U133M
<input checked="" type="checkbox"/>	<input checked="" type="checkbox"/> 10878627	ROPE,WIRE,14 MM DIA,44M LG,35WX7	N 1 EA
<input checked="" type="checkbox"/>	<input checked="" type="checkbox"/> BD/EKOM/19 07025	CRANE OVERHEAD TRAVELLING 15 T SOUTH	U133M
<input checked="" type="checkbox"/>	<input checked="" type="checkbox"/> 10555953	CRANE, OVERHEAD	00.00.0000 U133M 000005140958
<input checked="" type="checkbox"/>	<input checked="" type="checkbox"/> 10878872	CRANE,OVERHD TRAVL,1ST,DREGGEN,ELECT	1 EA
<input checked="" type="checkbox"/>	<input checked="" type="checkbox"/> BD/EKOM/19 07560	PADEYE TEST SWL 25T (FOR OT CRANE )	U133M
<input checked="" type="checkbox"/>	<input checked="" type="checkbox"/> 11786496	PADEYE, TEST SWL 25T (FOR OT CRANE )	00.00.0000 U133M 000018599803
<input checked="" type="checkbox"/>	<input checked="" type="checkbox"/> BD/EKOM/28 07025	SWITCH MAIN FOR OVERHEAD CRANE 19 07025	U133M
<input checked="" type="checkbox"/>	<input checked="" type="checkbox"/> BD/EKOM/28 07026	SWITCH PUSH BUTTON STATION FOR 19 07025	U133M
<input checked="" type="checkbox"/>	<input checked="" type="checkbox"/> 10878623	STATION,CNTL,FNDNT,XBW 5AS142,TELEMEC	1 EA
<input checked="" type="checkbox"/>	<input checked="" type="checkbox"/> BD/EKOM/28 08296	SWITCH EMERG STOP CRANE 19 07025	U133M
<input checked="" type="checkbox"/>	<input checked="" type="checkbox"/> 10356809	BUTTON,CEAG,GHG-4118100-R0002,EMERGENCY	N 1 EA
<input checked="" type="checkbox"/>	<input checked="" type="checkbox"/> BD/EKOM/28 JE-07025	BOX JUNCTION OVERHEAD CRANE 19 07025	U133M
<input checked="" type="checkbox"/>	<input checked="" type="checkbox"/> BD/EKOM/28 JE-07026	BOX JUNCTION. OVERHEAD CRANE 19 07025	U133M
<input checked="" type="checkbox"/>	<input checked="" type="checkbox"/> BD/EKOM/28 LCP-07025	PANEL CONTROL. OVERHEAD CRANE 19 07025	U133M
<input checked="" type="checkbox"/>	<input checked="" type="checkbox"/> 10878953	PANEL,CNTL,INCNS575727+INCNS573827,DREGGEN	N 1 EA
<input checked="" type="checkbox"/>	<input checked="" type="checkbox"/> 10488932	TIMER,ON DELAY,LA4-DT2U,TELEMECANIQUE	N 1 EA
<input checked="" type="checkbox"/>	<input checked="" type="checkbox"/> 10870600	CONTACTOR,LC1-D0907,TELEMECANIQUE	N 5 EA
<input checked="" type="checkbox"/>	<input checked="" type="checkbox"/> 10878372	CONTACTOR,LC1-D32P7,TELEMECANIQUE	N 5 EA
<input checked="" type="checkbox"/>	<input checked="" type="checkbox"/> 10878373	RELAY,CONTROL,CAD-32P7,TELEMECANIQUE	N 5 EA
<input checked="" type="checkbox"/>	<input checked="" type="checkbox"/> 10878374	BLK,CONT,LAD-T2,TELEMECANIQUE,TIME DELAY	N 1 EA
<input checked="" type="checkbox"/>	<input checked="" type="checkbox"/> 10878375	RELAY,THERM,LT3-SA00M,TELEMECANIQUE	N 3 EA
<input checked="" type="checkbox"/>	<input checked="" type="checkbox"/> 10878379	CONVERTER,KFA6-SR2-EX2.W,PEPPERL+FUCHS	N 4 EA
<input checked="" type="checkbox"/>	<input checked="" type="checkbox"/> 10472432	PCS-MCCR All Elektro	1 EA
<input checked="" type="checkbox"/>	<input checked="" type="checkbox"/> BD/EKOM/30 07025	MOTOR HOIST. CRANE OVERHEAD 19 07025	U133M
<input checked="" type="checkbox"/>	<input checked="" type="checkbox"/> 10556131	MOTOR, ELECTRICAL	00.00.0000 U133M 000005141136
<input checked="" type="checkbox"/>	<input checked="" type="checkbox"/> 10878853	MOTOR,ELECT,PB25-200-LB-4/12,CEMP	N 1 EA
<input checked="" type="checkbox"/>	<input checked="" type="checkbox"/> 10623297	BEARING,BALL,6212-22-C3,SKF	N 2 EA
<input checked="" type="checkbox"/>	<input checked="" type="checkbox"/> 10878464	BRAKE,ASSY,PY-3C,CEMP,FOR EL MOTOR	N 1 EA
<input checked="" type="checkbox"/>	<input checked="" type="checkbox"/> 10878853	MOTOR,ELECT,PB25-200-LB-4/12,CEMP	1 EA
<input checked="" type="checkbox"/>	<input checked="" type="checkbox"/> 10623297	BEARING,BALL,6212-22-C3,SKF	N 2 EA
<input checked="" type="checkbox"/>	<input checked="" type="checkbox"/> 10878464	BRAKE,ASSY,PY-3C,CEMP,FOR EL MOTOR	N 1 EA
<input checked="" type="checkbox"/>	<input checked="" type="checkbox"/> BD/EKOM/30 07026	MOTOR TROLLEY. CRANE OVERHEAD 19 07025	U133M
<input checked="" type="checkbox"/>	<input checked="" type="checkbox"/> 10556132	MOTOR, ELECTRICAL	00.00.0000 U133M 000005141137

<input checked="" type="checkbox"/>	<input checked="" type="checkbox"/>	<input checked="" type="checkbox"/>	10878858	MOTOR, ELECT, DB35-90-S-4, CEMP, 690V, 60HZ	N		1	EA
<input checked="" type="checkbox"/>	<input checked="" type="checkbox"/>	<input checked="" type="checkbox"/>	10000998	BEARING, BALL, RADIAL, 6205-2Z, SKF	N		2	EA
<input checked="" type="checkbox"/>	<input checked="" type="checkbox"/>	<input checked="" type="checkbox"/>	10878755	BRAKE, ASSY, MEC-80, CEMP, FOR EL MOTOR	N		1	EA
<input checked="" type="checkbox"/>	<input checked="" type="checkbox"/>	<input checked="" type="checkbox"/>	10878858	MOTOR, ELECT, DB35-90-S-4, CEMP, 690V, 60HZ			1	EA
<input checked="" type="checkbox"/>	<input checked="" type="checkbox"/>	<input checked="" type="checkbox"/>	10000998	BEARING, BALL, RADIAL, 6205-2Z, SKF	N		2	EA
<input checked="" type="checkbox"/>	<input checked="" type="checkbox"/>	<input checked="" type="checkbox"/>	10878755	BRAKE, ASSY, MEC-80, CEMP, FOR EL MOTOR	N		1	EA
<input checked="" type="checkbox"/>	<input checked="" type="checkbox"/>	<input checked="" type="checkbox"/>	BD/EKOM/30 07027	MOTOR TRAVELLING. CRANE OVERHEAD 19 07025 U133M				
<input checked="" type="checkbox"/>	<input checked="" type="checkbox"/>	<input checked="" type="checkbox"/>	10556133	MOTOR, ELECTRICAL		00.00.0000 U133M		000005141138
<input checked="" type="checkbox"/>	<input checked="" type="checkbox"/>	<input checked="" type="checkbox"/>	10878858	MOTOR, ELECT, DB35-90-S-4, CEMP, 690V, 60HZ	N		1	EA
<input checked="" type="checkbox"/>	<input checked="" type="checkbox"/>	<input checked="" type="checkbox"/>	10000998	BEARING, BALL, RADIAL, 6205-2Z, SKF	N		2	EA
<input checked="" type="checkbox"/>	<input checked="" type="checkbox"/>	<input checked="" type="checkbox"/>	10878755	BRAKE, ASSY, MEC-80, CEMP, FOR EL MOTOR	N		1	EA
<input checked="" type="checkbox"/>	<input checked="" type="checkbox"/>	<input checked="" type="checkbox"/>	10878858	MOTOR, ELECT, DB35-90-S-4, CEMP, 690V, 60HZ			1	EA
<input checked="" type="checkbox"/>	<input checked="" type="checkbox"/>	<input checked="" type="checkbox"/>	10000998	BEARING, BALL, RADIAL, 6205-2Z, SKF	N		2	EA
<input checked="" type="checkbox"/>	<input checked="" type="checkbox"/>	<input checked="" type="checkbox"/>	10878755	BRAKE, ASSY, MEC-80, CEMP, FOR EL MOTOR	N		1	EA
<input checked="" type="checkbox"/>	<input checked="" type="checkbox"/>	<input checked="" type="checkbox"/>	BD/EKOM/30 07028	MOTOR TRAVELLING. CRANE OVERHEAD 19 0702 U133M				
<input checked="" type="checkbox"/>	<input checked="" type="checkbox"/>	<input checked="" type="checkbox"/>	10556134	MOTOR, ELECTRICAL		00.00.0000 U133M		000005141139
<input checked="" type="checkbox"/>	<input checked="" type="checkbox"/>	<input checked="" type="checkbox"/>	10878858	MOTOR, ELECT, DB35-90-S-4, CEMP, 690V, 60HZ	N		1	EA
<input checked="" type="checkbox"/>	<input checked="" type="checkbox"/>	<input checked="" type="checkbox"/>	10000998	BEARING, BALL, RADIAL, 6205-2Z, SKF	N		2	EA
<input checked="" type="checkbox"/>	<input checked="" type="checkbox"/>	<input checked="" type="checkbox"/>	10878755	BRAKE, ASSY, MEC-80, CEMP, FOR EL MOTOR	N		1	EA
<input checked="" type="checkbox"/>	<input checked="" type="checkbox"/>	<input checked="" type="checkbox"/>	10878858	MOTOR, ELECT, DB35-90-S-4, CEMP, 690V, 60HZ			1	EA
<input checked="" type="checkbox"/>	<input checked="" type="checkbox"/>	<input checked="" type="checkbox"/>	10000998	BEARING, BALL, RADIAL, 6205-2Z, SKF	N		2	EA
<input checked="" type="checkbox"/>	<input checked="" type="checkbox"/>	<input checked="" type="checkbox"/>	10878755	BRAKE, ASSY, MEC-80, CEMP, FOR EL MOTOR	N		1	EA
<input checked="" type="checkbox"/>	<input checked="" type="checkbox"/>	<input checked="" type="checkbox"/>	BD/EKOM/43 ZS-01868	SWITCH POS HOOK TOP OVERH CRANE 19 07025 U133M				
<input checked="" type="checkbox"/>	<input checked="" type="checkbox"/>	<input checked="" type="checkbox"/>	10878336	SWITCH, PROX, NJ20+U1+N, PEPPERL & FUCHS			1	EA
<input checked="" type="checkbox"/>	<input checked="" type="checkbox"/>	<input checked="" type="checkbox"/>	BD/EKOM/43 ZS-01869	SWITCH POS HOOK BOTT OVERH CRN 19 07025 U133M				
<input checked="" type="checkbox"/>	<input checked="" type="checkbox"/>	<input checked="" type="checkbox"/>	10878336	SWITCH, PROX, NJ20+U1+N, PEPPERL & FUCHS			1	EA
<input checked="" type="checkbox"/>	<input checked="" type="checkbox"/>	<input checked="" type="checkbox"/>	BD/EKOM/43 ZS-01870	SWITCH POS TROLLY OVERH CRANE 19 07025 U133M				
<input checked="" type="checkbox"/>	<input checked="" type="checkbox"/>	<input checked="" type="checkbox"/>	10878336	SWITCH, PROX, NJ20+U1+N, PEPPERL & FUCHS			1	EA
<input checked="" type="checkbox"/>	<input checked="" type="checkbox"/>	<input checked="" type="checkbox"/>	BD/EKOM/43 ZS-01871	SWITCH POS TROLLY OVERH CRANE 19 07025 U133M				
<input checked="" type="checkbox"/>	<input checked="" type="checkbox"/>	<input checked="" type="checkbox"/>	10878336	SWITCH, PROX, NJ20+U1+N, PEPPERL & FUCHS			1	EA
<input checked="" type="checkbox"/>	<input checked="" type="checkbox"/>	<input checked="" type="checkbox"/>	BD/EKOM/43 ZS-01872	SWITCH POS TRAVEL OVERH CRANE 19 07025 U133M				
<input checked="" type="checkbox"/>	<input checked="" type="checkbox"/>	<input checked="" type="checkbox"/>	10878336	SWITCH, PROX, NJ20+U1+N, PEPPERL & FUCHS			1	EA
<input checked="" type="checkbox"/>	<input checked="" type="checkbox"/>	<input checked="" type="checkbox"/>	BD/EKOM/43 ZS-01873	SWITCH POS TRAVEL OVERH CRANE 19 07025 U133M				
<input checked="" type="checkbox"/>	<input checked="" type="checkbox"/>	<input checked="" type="checkbox"/>	10878336	SWITCH, PROX, NJ20+U1+N, PEPPERL & FUCHS			1	EA

## D Work Standards

### D.1 WS-19OVER30.M

WS-19OVER30.M      INSPEKSJON ELEKTRISK KRAN. AM

Denne arbeidsbeskrivelsen gjelder elektrisk driven talje med løpekatt og evt. bro. (Se egen arbeidsbeskrivelse for motor.)

- 1 . Rengjør løfteutstyr ved behov.
2. Kontroller for riktig merking.  
(Tagnummer SWL merking og ID nummer.  
Evt. tagbeskrivelse og sikkerhetsmerking).
3. Kontroller for generell tilstand og vær spesielt oppmerksom på følgende:
  - Skader og korrosjon, på løfteinnretning og kranbaner.
  - Kranbanens oppheng og endestoppere.
  - Styretablået er merket med funksjon.
  - Elektrisk hovedbryter. (Merket med krannr.)
4. Kontroller løpekattens, og evt. broens hjul for:
  - Fri bevegelse.
  - Opplagring.
  - Klaring mellom hjul og flens.
5. Kontroller ståltau/kjetting for skade, slitasje og korrosjon.  
NB! DET ER VIKTIG AT KJETTINGEN HENGER RETT.
6. Kontroller blokk og krankrok, og påse at sikkerhetsleppe fungerer.
7. Kontroller at lastebærende/sikkerhetsrelaterte bolteforbindelser er tiltrukket.
8. Smør talje, løpekatt og evt. bro ved behov. (Ref. vedlikeholdsmanualen.)
9. Smør tannstenger og sjekk eventuelle bolteforbindelser
10. Kontroller oljenivå på gearkasse/kasser. Etterfyll ved behov.
11. Kontroller kabler, kabelvogner og kabelbaner for skader.
12. Kontroller at overlastvernet er forseglet  
(Typen PIAB skal henge i avlastningskjetting/ståltau)
13. Funksjonsprøv løfteinnretning. Kontroller at alle endestoppere/brytere fungerer. Styretablåets vekt skal henge i avlastningskabelen.

## D.2 WS-19OVER32.M

WS-19OVER32.M OLJESKIFT TRAVERSKRAN.AM

1. Kontroller at skilt for oljetype er riktig. Monter der det mangler.
2. Skift olje på gear. Kontroller oljens farge og konsistens. Ved mistanke om uregelmessigheter, ta oljeprøve for analyse. (Se workstandard 000LJE01.M). Brukt olje deponeres tilbake til produksjonen.
3. Rengjør oljereservoarets pustefilter.

### D.3 WS-19OVER33.M

WS-19OVER33.M FUNKSJONSTEST BREMSEFUNKSJON. ME

1. Kontroller bremsejustering/bremsebelegg i h.h.t. brukermanualen Juster/bytt ved behov. Blir ikke utført på Profi taljer.
2. Kontroller bremsefunksjon med maksimum SWL.
3. Kontroller at overlastvernet kobler inn ved 5-10% over SWL.
4. Skriv notifikasjon i SAP dersom overlastvern og bremsler ikke fungerer som tiltenkt.

For test av bremsler og overlastvern brukes det dynamometer/vektcelle og fastpunkt eller lodd/vannbag. Brukes det fastpunkt anbefales det å ha en lengst mulig fiberstropp mellom fastpunkt og talje for å få litt "fjæring".

NB!

Kjør forsiktig da løfteinnretningen kan bli overbelastet dersom en kjører med maks fart. Prøv flere ganger for å få korrekt resultat.

Denne testen blir normalt utført av kranmekanikere rundt på feltet.

På plattformer der det foregår boring ligg det operasjoner mot drillingmekaniker. Dersom det er usikkerhet ang test av bremsler og overlastvern kan en kontakte kraninspektør eller kranmekanikere for råd/informasjon.



## D.4 WS-19OVER45.M

WS-19OVER45.M SMØREKART 25T TRAVERSKRAN

Smørekart til 25T Dreggen kraner EkoM

- BD/EKOM/840/19 07010
- BD/EKOM/840/19 07015

Ref: Brukermanual SAP dok: BD/E900-11915-M-00062 Rev 02

Kunde : ConocoPhillips/ Aker Kvernær AS  
Utstyr : EOT Kraner SWL 25T & 15T  
Dok.Nr.: E900-11915-M-00062

Leverandør : DREGGEN CRANE AS  
Prosjekt : EKOFISK 2/4M Wellhead & Process  
Rev.: 02

PO No	Tag No	System No	Lube Point Seq No	Lubrication Point Description	Comments	Supplier Oil Name	Supplier Oil Type	CoPNo Oil Name and Type Equivalent	Quantity first fill	Quantity normal	Quantity Unit (l)	Change Frequency First	Change Frequency Normal	Cross ref. to lubrication chart	Cross ref. to Drawings
R-1006	19-07010/15	M	1	Travel gear for crane	Oil bath	Hydro Texaco	Meropa 150		4,8 ltr.			2500 hrs	After 4 Years	E900-11915-M-00056	Lubohat 655
R-1006	19-07010/15	M	2	Crane drive pinion & gear rack	Brushed	Hydro Texaco	Moliltex EP2		2 kg			500 hrs	After 1 Year	E900-11915-M-00056	Lubohat 655
R-1006	19-07010/15	M	3	Open gear for crane drive arr.	Brushed	Hydro Texaco	Moliltex EP2		0,5 kg			100 hrs	After 1 Year	E900-11915-M-00056	Lubohat 655
R-1006	19-07010/15	M	4	Chain & chain wheels	Spray	Reca Norge AS	TUNAP 358		As required			100 hrs	After 1 Year	E900-11915-M-00056	Lubohat 655
R-1006	19-07010/15	M	5	Foot bearings	Greasegun	Hydro Texaco	Texclad Premium 2		1,0 kg			100 hrs	After 1 Year	E900-11915-M-00056	Lubohat 655
R-1006	19-07010/15	M	6	Flange bearings	Greasegun	Hydro Texaco	Texclad Premium 2		0,2 kg			100 hrs	After 1 Year	E900-11915-M-00056	Lubohat 655
R-1006	19-07010/15	M	7	Intermediate gear hoist	Oil bath	Hydro Texaco	Meropa 150		1,0 ltr.			2500 hrs	After 4 Years	E900-11915-M-00056	Lubohat 655
R-1006	19-07010/15	M	8	Main gear hoist	Oil bath	Hydro Texaco	Meropa 150		31 ltr.			2500 hrs	After 4 Years	E900-11915-M-00056	Lubohat 655
R-1006	19-07010/15	M	9	Travel gear for trolley	Oil bath	Hydro Texaco	Meropa 150		8,5 ltr.			2500 hrs	After 4 Years	E900-11915-M-00056	Lubohat 655
R-1006	19-07010/15	M	10	Trolley drive pinion & gear rack	Brushed	Hydro Texaco	Moliltex EP2		1,0 kg			500 hrs	After 1 Year	E900-11915-M-00056	Lubohat 655
R-1006	19-07010/15	M	11	Trolley wheel bogie connection	Greasegun	Hydro Texaco	Texclad Premium 2		0,2 kg			100 hrs	After 1 Year	E900-11915-M-00056	Lubohat 655
R-1006	19-07010/15	M	12	Wire drum bearings	Greasegun	Hydro Texaco	Texclad Premium 2		0,2 kg			100 hrs	After 1 Year	E900-11915-M-00056	Lubohat 655
R-1006	19-07010/15	M	13	Wire rope	Brushed	Hydro Texaco	Texclad Premium 2		0,5 kg			100 hrs	After 1 Year	E900-11915-M-00056	Lubohat 655
R-1006	19-07010/15	M	14	Wire drum	Brushed	Hydro Texaco	Texclad Premium 2		0,2 kg			100 hrs	After 1 Year	E900-11915-M-00056	Lubohat 655
R-1006	19-07010/15	M	15	Lower block swivel	Greasegun	Hydro Texaco	Texclad Premium 2		0,1 kg			100 hrs	After 1 Year	E900-11915-M-00056	Lubohat 655

M:60182/DOK/BrukerManual L615-104A R02

WS-19OVER45.M SMØREKART 25T TRAVERSKRAN

Kunde : ConocoPhillips/ Aker Kværner AS  
Utstyr : EOT Kraner SWL 25T & 15T  
Dok.Nr.: E900-11915-M-00062

Leverandør : DREGGEN CRANE AS  
Prosjekt : EKOFISK 2/4M Wellhead & Process  
Rev.: 02

### 3.4 BILDER AV SMØREPUNKTER PÅ SWL 25TONS KRANER



OLJEFYLLING  
HOVED HEISEGIR

OLJEFYLLING  
MELLOMGIR  
HEISING

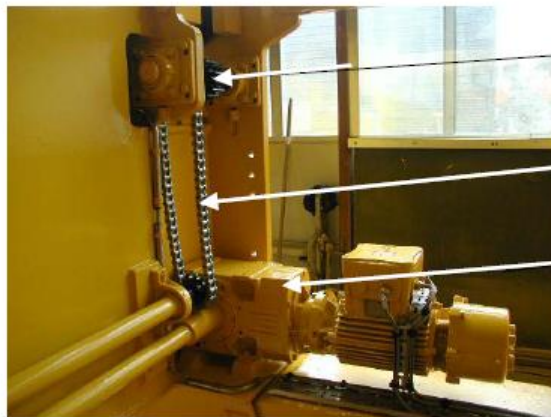

TANNHJULSDREV  
FOR  
KRANKJØRING

KJEDEHJUL/SYKKE-  
KJEDE TRANSMISSJON

KRAN KJØREGIR

M:\60282\DOE\BrukerManual L655-504A R02

Rev.0 MG/24.02.2011

2 av 4

WS-19OVER45.M SMØREKART 25T TRAVERSKRAN

Kunde : ConocoPhillips/ Aker Kværner AS  
Utstyr : EOT Kraner SWL 25T & 15T  
Dok.Nr.: E900-11915-M-00062

Leverandør : DREGGEN CRANE AS  
Prosjekt : EKOFISK 2/4M Wellhead & Process  
Rev.: 02



SMØRENIPPEL FOR TROMMELLAGER

SMØRENIPPEL UNDERBLOKK

LOPEKATT KJØREGIR OLJEFYLLING

LOPEKATTKJØRING TANNHJULSDREV// TANNSTANG



LOPEKATT LOPEHJULBOGGI SMØRENIPPEL

M:\60282\DOE\BrukerManual L655-504A R02

WS-19OVER45.M SMØREKART 25T TRAVERSKRAN

Kunde : ConocoPhillips/ Aker Kværner AS  
Utsyrt : EOT Kraner SWL 25T & 15T  
Dok.Nr.: E900-11915-M-00062

Leverandør : DREGGEN CRANE AS  
Prosjekt : EKOFISK 2/4M Wellhead & Process  
Rev.: 02

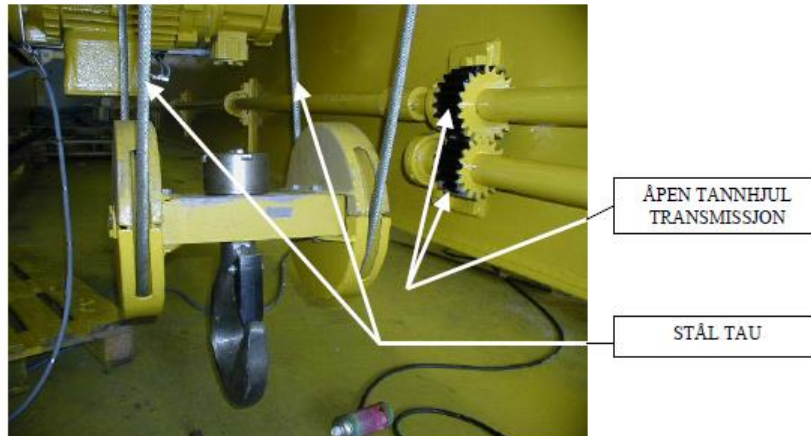

Rev.0 MG/24.02.2011

4 av 4



WS-19OVER46.M SMØREKART 15T TRAVERSKRAN

Kunde : ConocoPhillips/ Aker Kværner AS  
Utstyr : EOT Kraner SWL 25T & 15T  
Dok.Nr.: E900-11915-M-00062

Leverandør : DREGGEN CRANE AS  
Prosjekt : EKOFISK 2/4M Wellhead & Process  
Rev.: 02

### 3.5 BILDER AV SMØREPUNKTER PÅ SWL 15TONS KRANER

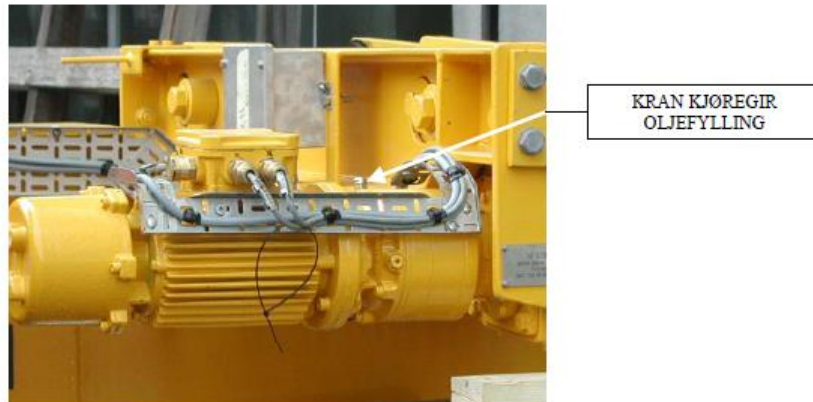
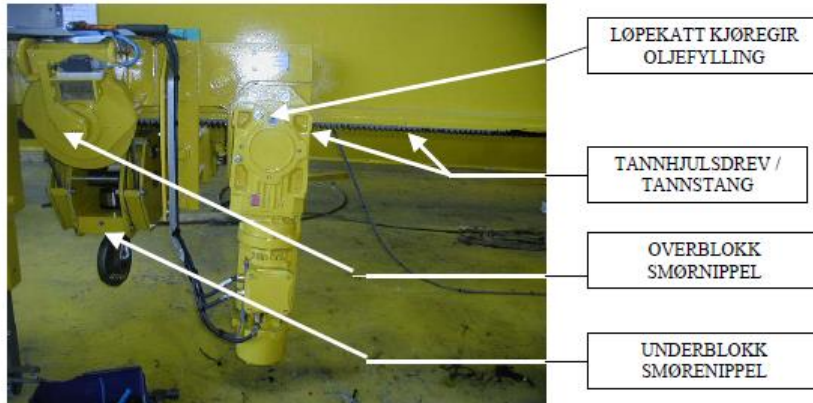

M:60282 DOK:BrukerManual L655-504A R02

Rev.0 MG/24.02.2011

2 av 3



WS-19OVER46.M SMØREKART 15T TRAVERSKRAN

Kunde : ConocoPhillips/ Aker Kværner AS  
Utstyr : EOT Kraner SWL 25T & 15T  
Dok.Nr.: E900-11915-M-00062

Leverandør : DREGGEN CRANE AS  
Prosjekt : EKOFISK 2/4M Wellhead & Process  
Rev.: 02

---



TANNHJULSDREV/  
TANNSTANG

WIRETROMMEL/  
STÅLTAU

WIREFORING



## D.6 WS-19OVER59.M

WS-19OVER59.M      INSPEKSJON OG SMØRING STÅLTAU TRAVERS Kraner

Denne arbeidsbeskrivelsen gjelder 25 tonn SWL Barnsley traverskraner på EKOZ og ELDS og 15 og 25 tonn SWL Dreggen kraner på EKOM. På EKOZ og ELDS må dette utføres ved hjelp av personløfter eller lignende for å komme til hele tauet inklusiv endefester, spoling og vinsjens trommel. Tauet må ruller ut så mye som mulig før inspeksjonen foretas. Inspeksjonen skal for øvrig utføres i henhold til retningslinjer i ISO 4309, se for øvrig kap.5 og vedlegg A i denne for noen generelle retningslinjer.

### Veiledning for inspeksjonen:

#### 1 Visuell inspeksjon:

- 1.1 Sjekk for korrosjon og vurder i henhold til ISO 4309 tabell 6
- 1.2 Sjekk for ytre skader på tauet
- 1.3 Sjekk for deformasjoner, mekaniske skader og klemskader
- 1.4 Kontrollmål diameter på utsatte steder og sjekk at denne ikke varierer med mer enn max 5% mellom største og minste målte verdi sammenlignet med der tauet ikke utsettes for slitasje og påkjenning.
- 1.5 Inspiser hele tauet for trådbrudd, og bruk kasseringskriterier i ISO 4905 tabell 2 ved funn.
- 1.6 Inspiser endefester og trommelforankring

#### 2 Funksjonstest:

- 2.1 Sjekk at tauet spoles riktig på trommelen og over skivene ved å kjøre med en lett last
- 2.2 Sjekk at tauet glir lett gjennom skivene og at alle skivene roterer

#### 3 Smøring

- 3.1 Tauet smøres ved behov med Brilube 30 eller tilsvarende, som er lagerført
- 3.2 Andre bevegelige flater som skal smøres i forbindelse med ståltauet og dets komponenter smøres med smørefett av typen Starplex EP 2 eller tilsvarende, som er lagerført.

Ved funn vurderes disse i samsvar med ISO 4309 tabell 1 og vedlegg F og om alvorlighetsgraden er vurdert til å være:

- «Trygt å fortsette»      Ingen videre tiltak
- Andre kommentarer      Kraninspektør kontaktes for vurdering

Om ståltauet vurderes å være i så dårlig stand at det klassifiseres som at det skal kasseres så stenges kranen og det opprettes en notifikasjon på bytting.

## D.7 WS-30MOTO68.E

WS-30MOTO68.E EL. MOTORER, KONTROLL OG EX-KONTROLL

1. Kontroller og rengjør merkeskilt, motor og potensial forbindelse. Sprayes evt. med tectyl. Hvis skiltene er løse, må de festes. Hvis merkeskilt er ødelagt eller forsvunnet, er sertifiseringen tapt og ny motor må monteres. Nytt merkeskilt kan evt. bestilles og monteres når den originale dataer kan fremskaffes. Kontroller for øvrig riktig merking (tagnummer, evt. beskrivelse, Ex og sikkerhetsmerking).
2. Skru opp deksel på koplingshus/koblingsboks og kontroller at det ikke er vann/korrosjon innvendig. Kontroller alle forbindelser. Sjekk at pakningen i lokket er hel, skift om nødvendig. Maskinerte flammespalter (Exd) skal være glatt/ren og uten pakning. Smør pakningen/flammespalten inn med hvit vaselin før lokket skrues på igjen. Alle skruer skal være hele og på plass.
3. Rengjør motoren utvendig. Ikke spyl med vann. Se etter korrosjon. Ved behov for vedlikehold evt. maling skrives M1-notifikasjon. Kontroller og smør gjenger for øyebolt.
4. Kontroller kjølevifte og vifteskjold (for å sikre gunstigst mulig drifts temperatur). Inspiser vifteblad og nagler, og påse at disse ikke er løse. Kontroller også at motor vifteblad har tilstrekkelig klaring til kapsling.
5. Kontroller kabler, kabelinnføringer og klamring og at de er fri for skader og at kabelinnføringer er tette.
6. Sjekk all jording, ettertrekk fundament bolter. Sett inn bolter og skruer samt eventuell utvendig jordklemme med fett.
7. Kontroller at motorvarmer virker (hvis montert).
8. Kontroller at temperaturføler virker (hvis montert).
9. Kontroller eventuelle drivreimer for stramming og slitasje, evt. brudd. Skift dersom nødvendig.
10. Gjelder oljesmurte motorer: Kontroller oljenivå, etterfyll om nødvendig. Sjekk mot uakseptable lekkasjer.
11. Skru opp deksel på lokal start/stopp bryter og kontroller at det ikke er vann/korrosjon innvendig. Kontroller alle forbindelser. Sjekk at pakningen i lokket er hel, skift om nødvendig. Smør pakningen/flammespalten inn med hvit vaselin før lokket skrues på igjen. Alle skruene skal være hele og på plass. Funksjonstest bryteren når motoren er låst opp igjen.
12. Kontroller eventuelle EX-layout tegninger og påse at aktuell motor og lokale brytere merkes med en \* (Ex-pm blir ivaretatt i forbindelse med annet vedlikeholdsarbeid).
13. Sjekk starter skuffen for løse forbindelser

## **E Analyses**

### **E.1 25 T Crane 07010**

Available in separate file.

### **E.2 25 T Crane 07015**

Available in separate file.

### **E.3 15 T Crane 07020**

Available in separate file.

### **E.4 15 T Crane 07025**

Available in separate file.

## F Minutes of meetings

### Møtereferat 22.01.18

mandag 22. januar 2018 13.31

Agenda: Oppstartsmøte hos ConocoPhillips for Masteroppgave. Gjennomgang av oppgave, plan, rapportering m.m.

Tilstede: Torbjørn Gjerde, Sukhvir Panesar, Morten Birch Emmerhoff og Øystein Refsland Andreassen

- Presentasjonen som ble oversendt i e-post 21. Januar ble gjennomgått.
- Viktig å få med begrunnelse på hvorfor kranene
  - Blir ikke brukt mye, men går 24/7 når de er i bruk.
  - Vanskelig med levetidsanalyser
- For identifisering gjennom oppgaven bør et brukes ConocoPhillips tag type: BD/EKOM/840/19 07020.....
  - Forklaring på tag:
  - BD - Avdeling Norge
  - EKOM - Ekofisk M
  - 840 - Hovedgruppe materialhåndtering
  - 19 - Undergruppe løfteutstyr
  - (07020) eller siste numre er løpenummer.
- Leveranser blir:
  - Revidert PM-program
  - Analysemateriale
  - Kopi av oppgave, holder med elektronisk utgave.
- Mål for oppgave må beskrives bredere, og mer generelt. Mål kan ikke være leveransen.
- I WBS må det inn antikollisjon og andre instrumenter.
- ISO 14224 tas i bruk for system. Hvis ConocoPhillips har 2016-kopi ønsker undertegnede denne.
- Morten tar ut SAP-struktur. Struktur med oversikt av komponenter i kranen.
- Det legges opp til fire møter i februar:
  - Gjennomgang av SAP notifikasjonshistorikk - Uke 6? (onsdag - fredag passer best for undertegnede)
  - Intervju av brønnintervensjons-personell (brukere/vedlikeholdspersonell) - Uke 7? (mandag - fredag)
  - Møte for kikk i scanningportal, for å kunne se på kranene offshore (bilder). - Uke 7?(mandag - fredag) (Kan gjøres på samme dag?)
  - Møte med Sukhvir for å kvalitetssikre teorien. - Uke 9? (mandag - fredag)

## Minutes of meeting 08.02.18

torsdag 8. februar 2018 12.29

### Agenda:

Review of notifications

### Participants:

Torbjørn Gjerde, Jarle Bråstein, Øystein Refsland Andreassen

### Room:

D311, ConocoPhillips.

- Review and grouping of notifications for 25T cranes. TAG 07010 and 07015.
  - Groups: Runway, Trolley, Bridge, Hoist, Instrument and Other
- Priority of given PMO-tasks:
  - E - Rectify in 14 days
  - 1 - Rectify in 3 months
  - 2 - Rectify in 6 months
- One major modification project was done on the cranes in 2009.
  - Modification of the bridge drive
  - Installation of radio remotes
  - Installation of anti-collision system

For meeting on Monday:

- Check if the bridge is running south/north or east/west.
- Look through the reports from enterprise of competence.
- Torbjørn to do review of notifications for 15T cranes TAG 07020 and 07025.

## Minutes of meeting 12.02.18

mandag 12. februar 2018 21.26

**Agenda:**

Review of pictures and other documentation for Ekofisk M EOT cranes

**Participants:**

Torbjørn Gjerde, Øystein Refsland Andreassen and Morten Birch Emmerhoff

**Room:**

D311, ConocoPhillips.

- Reviewed the cardinal directions each crane is moving in:
  - Bridge for 25T cranes (Tag: 07010/07015) are running north/south
  - Trolleys for 25T cranes are running East/West
  - Bridge for 15T cranes (Tag: 07020/07025) are running East/West
  - Trolley for 15T cranes are running North/South
- Reviewed documentation for modifications of the 25T cranes.
- Morten and Torbjørn to check what changes were made to the PM program after modification in 2009.
- Torbjørn to supply the reports from enterprise of competence.
- Torbjørn to do review of notifications for 15T cranes TAG 07020 and 07025.

## Minutes of meeting 05.03.18

mandag 12. februar 2018 21.26

**Agenda:**

Review of RCM strategy for master thesis

**Participants:**

Torbjørn Gjerde, Sukhvir Panesar, Øystein Refsland Andreassen and Morten Birch Emmerhoff

**Room:**

C311, ConocoPhillips.

- Review of theory - Went through plan as is.
  - Method will be case study. See YIN2009.
    - Simple problem, case study is best method.
    - Compare PM vs. CM.
    - Electrical equipment, less PM task, only done CM.
- Morten will send:
  - Tag-list with criticality
  - Governing documents for maintenance, 6253 and 5047.
- Look for articles for RCM in Journal of Quality and Maintenance Engineering (JQMI).
  - Emerald database.
- Regarding classification and priority of PM tasks:
  - Missing in the organization
  - More or less not existing in projects.

## Minutes of meeting 18.04.18

fredag 20. april 2018 10:59

**Agenda:**

Gjennomgang av Øystein sin oppgave

**Participants:**

Torbjørn Gjerde, Sukhvir Panesar, Øystein Refsland Andreassen and Morten Birch Emmerhoff

**Room:**

D311, ConocoPhillips.

- Went through progress until now
- PM for junctions boxes and similar was not identified, this is because PM for Electro is specific for area, more than on equipment
- Drive chain was discussed - today's PM is updated with an interval of 3M
- Wire rope was discussed as this is a similar problem on all the cranes. COP explained there is an inherent weakness for skew load, even when have relative small fleet angles. The frequency increase is probably because the cranes are used more now?
- Agreed on submission for review week 18. The first complete thesis draft with analysis.
  - COP to give feedback within two weeks.
- Final submission in week 22
- Further work with discussion and conclusion were discussed.
  - Discussion of notifications. Try to show what could be done to make the notifications easier to understand.