

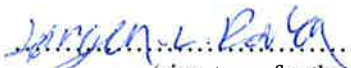

Universitetet
i Stavanger

FACULTY OF SCIENCE AND TECHNOLOGY

MASTER'S THESIS

| | |
|---|--|
| Study programme/specialisation: MSc. Biological Chemistry and Biotechnology. Organic Chemistry | Spring semester, 2018 Open |
| Author: Jørgen Ledaal Dalva |  (signature of author) |
| Programme coordinator: Eli Drange Vee Supervisor(s): Prof. Einar Bakstad | |
| Title of master's thesis: Anomeric O-Alkylation as a Diastereoselective Glycosylation Method | |
| Credits: 60 | |
| Keywords: Diastereoselectivity, Glycosylation, | Number of pages: 62 + supplemental material/other: 5 Stavanger, 29.06.2018 date/year |

Anomeric O-Alkylation as a Diastereoselective Glycosylation Method

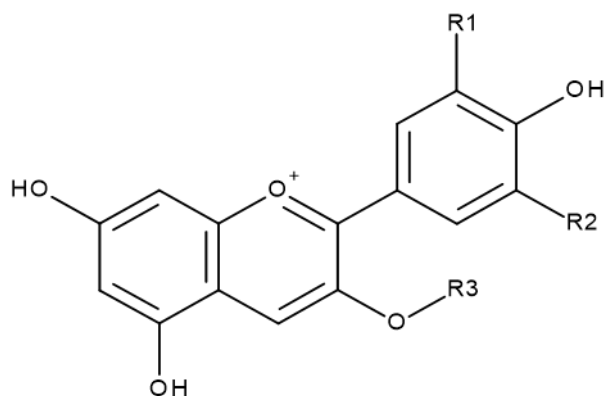

BiolinkGroup

Jørgen Ledaal Dalva (223796)

2018

Abstract

After the Biolink group's first full synthesis of the anthocyanins cyanidin and delphinidin in which the best results at the time were produced by anomeric O-alkylation of glucose. The Biolink research group was interested in discovering how versatile this reaction truly was. During the synthesis it was discovered that DCM (as solvent) and NaH (as base) yielded great selectivity towards β -glycoside. Bilal Khalid and Raul Manuel Peres later researched the effect of other solvent systems and Bilal discovered that DMF (as solvent) was α -selective and Manuel Peres with Ph.D. Jørn Naimak discovered Cs_2CO_3 (as base) made the reaction more α -selective in several circumstances.

This thesis aimed to investigate anomeric O-alkylation with new electrophiles and its strengths and weaknesses. Some discoveries were made that several other strong electrophiles that were not in the group of electrophiles previously used by students (acetophenones and α -haloesters) could be reacted with anomeric O-alkylation.

Another aim of the thesis was to find an easy and cheap synthesis of α or β -2,3,4,6-tetraacetate-D-Glucose. Three methods were already in use by the start of this master: Koenings-Knorr on α -1-bromo-2,3,4,6-tetraacetate-D-Glucose using water as nucleophile, ammonium acetate with 1,2,3,4,6-pentaacetate-D-Glucose (peracetylated glucose) in DMF or DMSO and Morpholine and peracetylated glucose in MeCN or before mentioned solvents

What was discovered was one alternate reaction and a new solvent for said reaction, which employed bubbling ammonia through a solution of MeCN or DMF with peracetylated glucose.

Student Katja Håheim (B.Sc.) had faced significant problems with peracetylated sugar as a side product in the reaction. Several key factors for formation of peracetylated sugar was tested and means to mitigate this problem was discovered, a new solvent system for flash chromatography was also discovered to be much more fit to separate products.

Of the glycosides synthesized during this master thesis 2β and 4α glycosides were synthesized that to the authors best knowledge were novel, given below as (*).

Anomeric O-Alkylation as a Diastereoselective Glycosylation Method

Varying yields were observed using the anomeric O-alkylation: ranging from 9-51%.

- 2-(2,3,4,6-tetra-O-acetyl- α -D-glucopyranosyloxy)cyclohexanone (*) (Yield: 35% (purified))
- 2-(2,3,4,6-tetra-O-acetyl- α -D-glucopyranosyloxy)acetonitrile (*) (Yield: 24% (purified))
- 2-(2,3,4,6-tetra-O-acetyl- α -D-glucopyranosyloxy)ethylacetate (Yield: 22% (purified))
- 2-(2,3,4,6-tetra-O-acetyl- α -D-glucopyranosyloxy)benzylacetate (Yield: 39% (purified))
- *tert*-Butyl 2-(2,3,4,6-tetra-O-acetyl- α -D-glucopyranosyloxy)acetoacetate (*) (Yield: 51% (purified))
- 2-bromo-1-(2,3,4,6-tetra-O-acetyl- α -D-glucopyranosyloxy)prop-2-ene (*) (Yield: 9% (purified))
- 1-(2,3,4,6-tetra-O-acetyl- β -D-glucopyranosyloxy)triphenylmethane (Yield: 30% (purified))
- 2-(2,3,4,6-tetra-O-acetyl- β -D-glucopyranosyloxy)cyclopentanone (*) (Yield: 29% (Purified))
- 1-(2,3,4,6-tetra-O-acetyl- β -D-glucopyranosyloxy)acetonitrile (Yield: 31% (purified))
- 2-(2,3,4,6-tetra-O-acetyl- β -D-glucopyranosyloxy)ethylacetate (Yield: 30% (purified))
- 2-(2,3,4,6-tetra-O-acetyl- β -D-glucopyranosyloxy)benzylacetate (Yield: 27% (Purified))
- 2-(2,3,4,6-tetra-O-acetyl- β -D-glucopyranosyloxy)cyclododecanone (*) (Yield: 50% (purified))

Some products were also produced from the glycoside *tert*butyl 2-(2,3,4,6-tetra-O-acetyl- α -D-glucopyranosyloxy)acetoacetate.

- 2-(2,3,4,6-tetra-O-acetyl- α -D-glucopyranosyloxy)acetoacetic acid (*) (Yield: 88%)
- 1-(2,3,4,6-tetra-O-acetyl- α -D-glucopyranosyloxy)propanone and 1-(2,3,4,6-tetra-O-acetyl- β -D-glucopyranosyloxy)propanone in a mixture (Yield: 50%)

Preface

I started working at the Biolink laboratories during the fall of 2017 for my master in biological chemistry which lasted approximately 9 months.

My supervisor for my project was professor Einar Bakstad, who is a director of research at Biosynth, and works as a professor teaching advanced organic chemistry at UiS.

I am very grateful for my time here at the Biosynth laboratories and would like to thank the Biolink group for having me as a master student and for providing the necessary equipment for my experiments. Further I would like to thank professor Einar Bakstad as my supervisor for his help and guidance through this thesis. It has been a pleasure to work in the lab and that has much to do with how welcoming Einar Bakstad is with ideas and helping prepare new exciting chemistry.

I would also like to thank the other students at the laboratory, Master student Dilita Maharjan and PhD student Jørn Holm Naimak for his help and guidance around the laboratory. Thank you Dilita for making the lab a fun and welcoming place to work and humoring my bad jokes. I would also like to thank Jørn Naimak for his patience in the lab and for helping shape ideas and experiments.

Thank you to Jorma Kinnari and Cargill, for allowing us to get better and more accurate NMR spectra from their 500 MHz NMR machine. Again, I would like to extend my gratitude to Einar Bakstad for your help interpreting the glycoside NMR results.

I'd like to thank the University of Stavanger, including Professor Kåre B Jørgensen for help with the 400MHz NMR machine as well as his maintenance of said NMR machine.

Thank you to my family without them I would never be where I am today, I would especially like to thank them for standing with me through everything and not giving up on me.

I would also like to give a broad thank you to all the great men and women who have made it their goal to further the scientific endeavor. Without the many people working within fields like medicine, engineering and just in general advancing technology I would not be here today.

Anomeric O-Alkylation as a Diastereoselective Glycosylation Method

| | |
|---|----|
| Abstract..... | 2 |
| Preface | 4 |
| 1 Introduction | 6 |
| 1.1 Carbohydrates and carbohydrate stereochemistry..... | 6 |
| 1.1.1 Anomeric effect on sugar | 7 |
| 1.2 History of the Bakstad research group | 7 |
| 1.3 Important glycosides | 9 |
| 1.3.1 Anthocyanins..... | 9 |
| 1.3.2 Glycosides as antibiotics | 10 |
| 1.3.3 Glycosides as antiparasitic drugs | 13 |
| 1.3.4 Glycosides in chemotherapy..... | 14 |
| 1.4 Goals and Objectives | 16 |
| 2 Theory..... | 17 |
| 2.1 Acidic α -halogenation of ketones | 17 |
| 2.2 Glycosylation..... | 18 |
| 2.2.1 Glycosylation using electrophilic sugar..... | 18 |
| 2.2.2 Glycosylation using nucleophilic sugar..... | 22 |
| 2.3 Solvent effects | 25 |
| 3 Results and discussion..... | 26 |
| 3.1 Production of α and β anomeric hemiacetal sugar | 26 |
| 3.2 Preparation of α -haloketones | 28 |
| 3.3 Glycosidation..... | 30 |
| 3.3.1 Investigation considering the formation of peracetylated glucose..... | 30 |
| 3.3.2 α -glycosides | 31 |
| 3.3.3 β -glycosides | 35 |
| 3.3.4 Michael addition in glycosylation..... | 39 |
| 4 Concluding remarks..... | 40 |
| 5 Experimental | 42 |
| 5.1 General..... | 42 |
| 5.2 Synthesis of D-glucose-2,3,4,6-tetraacetate..... | 44 |
| 5.3 Synthesis of α -haloketones..... | 46 |
| 5.4 General procedures for testing glycosylation conditions..... | 50 |
| 5.5 α -glycosylation | 52 |
| 5.6 β -glycosylation | 57 |
| Literature..... | 61 |
| Appendix..... | 63 |

1 Introduction

1.1 Carbohydrates and carbohydrate stereochemistry

Carbohydrates consisting of one subunit (monosaccharides) are defined and named according to length of carbon chain, side groups, side group stereochemistry and size of the ring structure^[1]. At the Bakstad research group the model carbohydrate used is D-glucose, one of nature's most abundant organic molecules. D-glucose consists of six carbons and in its' cyclic hemiacetal form it exists as a six membered ring with four equatorial hydroxy groups and one hemiacetal group which can be either β or α (anomeric hydroxy group)^[1b] (Scheme 1). In solution D-glucose goes through what is known as mutarotation where it ring opens and ring closes giving either an axial or equatorial anomeric hydroxy group^[2].

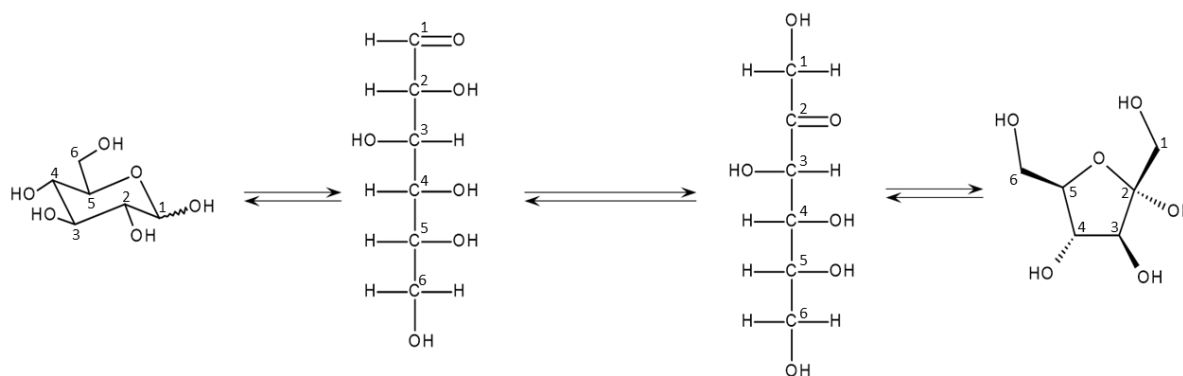

Scheme 1. Catalyzed isomerization of glucosepyranose (left) to fructosefuranose (right)^[3], showing of the naming scheme for sugars depending on the ring structure. C1 is not a stereogenic center as an open chain but gains one as it becomes cyclical, this produces the effect known as mutarotation.

In total D-glucose has five stereogenic centers to control, but on the model substrate for glycosylation, D-Glucose-2,3,4,6-tetraacetate (**3**), only the anomeric hydroxy group needs to be controlled as the other stereogenic centers are fixed^[1]. Many carbohydrates make large complex polymers, these polymers are called polysaccharides and serve as a medium to show the different abilities that can arise from axial (alpha, α) or equatorial (beta, β) coupling. Two natural polymers of glucose are cellulose and glycogen where cellulose is β (1 \rightarrow 4) linked^[4] and glycogen is α (1 \rightarrow 6) linked^[5]. Glycogen is a sugar storage molecule that is easily broken down and used for energy, whilst cellulose is a structural polymer and one of the strongest known natural polymers; found as the basic building block of all plants^[4].

1.1.1 Anomeric effect on sugar

The anomeric effect is an observed effect in heterocycles leading to the axial conformation often being more stable than expected or even preferred over the less sterically hindered equatorial conformation^[6]. The full extent of what causes the anomeric effect is still being explored, some of the most common explanations are: hyperconjugation^[6], dipole interactions^[7] and n-n* repulsion^[6].

Solvents can often have seemingly unpredictable effects on heterocycles and cause the anomeric effect to strengthen or lessen^[8]. D-glucose is a heterocycle with several hydroxy groups on the ring and is affected in often hard to predict ways by the anomer effect, but through empirical testing and empirical data some general understanding has been reached. Interestingly the equatorial conformer of D-glucose seems to be most stable in aqueous solution^[2] however this can be altered using different solvents and conditions^[9] (see Table 1).

Table 1. Table of solvents and corresponding amount of alpha conformer in %^[2].

| Solvent | Alpha |
|---------------------------|--------|
| Dimethyl sulfoxide (DMSO) | 44% |
| Pyridine | 45% |
| Water | 32-37% |

1.2 History of the Bakstad research group

The Bakstad research group has spent its time researching glycosylation of sugars using different conditions on D-glucose-2,3,4,6-tetraacetate (**3**) a glucose molecule with four protective groups, acetyl groups. The Biolink group's research was focused on achieving high yields of β -glycosides in the pursuit of an industrially viable general synthesis of anthocyanins. This research has been ongoing since early 2003 and in the time from then until now several discoveries had already been made^[10] (See Figure 1).

Anomeric O-Alkylation as a Diastereoselective Glycosylation Method

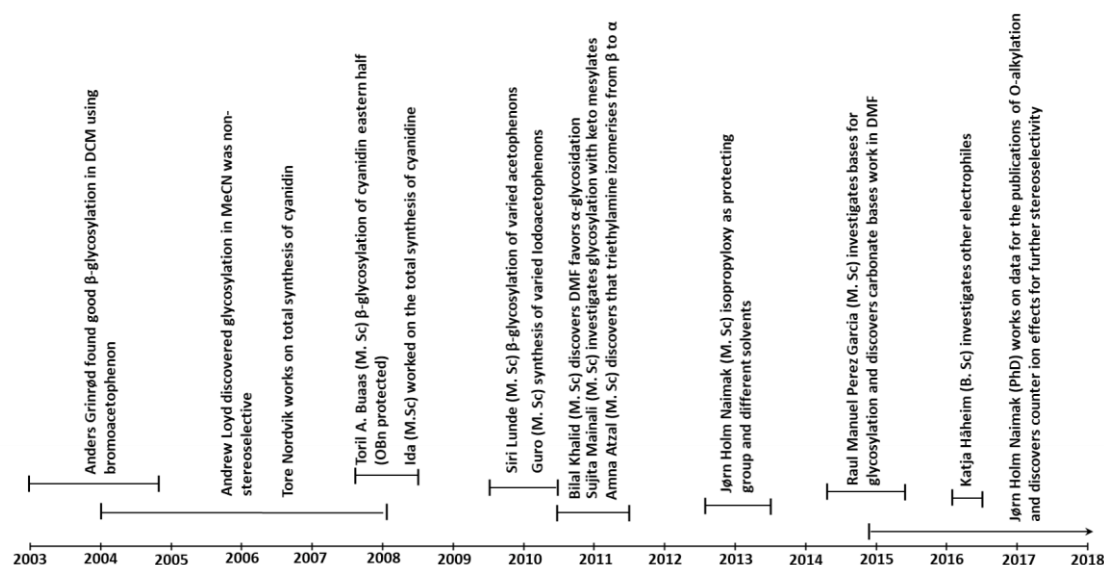

Figure 1. Time table showing the discoveries that have been made over time at the biosynth lab.

Professor Einar Bakstad theorized that if **3** was used as a nucleophile it could be directed using solvent polarity as it highly affects the stereochemistry of glucose^[10] (See Sections 1.1.1 and 2.3). In the beginning Anders Grinrød made the discovery that dichloromethane (DCM) gave nearly clean β -glycosides with several α -haloketones^[11]. Furthermore research was made into which leaving groups yielded the best results^[12], and also how other solvents affected the reaction^[10, 13].

Around 2006 the research group discovered that with more polar solvents more α -glycoside was formed^[10, 13] and in 2011 Bilal Khalid found *N,N*-dimethylformamide (DMF) to be a suitable candidate for diastereoselective α -glycosylation^[13].

This thesis is a continuation of the Bakstad research group's work on anomeric O-alkylation.

1.3 Important glycosides

Many important biologically active molecules are α or β -glycosides, to synthesize these molecules stereochemical control is both important and interesting.

Glycosylation is important in the synthesis of many natural products as well as synthetic glycosides: for example, glycosides like antibiotic, antiparasitic and chemotherapeutic drugs.

1.3.1 Anthocyanins

Anthocyanins are natural antioxidants that are commonly found in berries and plants where they can easily be identified by their wide range of powerful colors^[14]. In flowers anthocyanin pigments are often the main source of color and plays a very important role in attracting bees and other pollinators^[14]. Anthocyanins are glycosylated polyhydroxy flavylum salts with a positive charge stabilized by resonance^[15]. All anthocyanins discovered in nature are equatorial O-glycosides, no axial anthocyanins are known at this point^[14a, 15].

Anthocyanins are shown to have a large variety of positive medicinal effects. Most commonly the medicinal effect referred to is its effect as an antioxidant. Antioxidants are thought to prevent the damage that may come from radicals being produced in the body during normal cellular function^[16] and therefore it could be important in hindering DNA damage.

Newer research also indicates that it could be useful as an anti-inflammatory agent; anthocyanins have been shown to downregulate NF κ B^[17] an inflammatory response protein that promotes inflammation and subsequent immune response. NF κ B is why anthocyanins could be effective as anti-inflammatory agents and could aid in treating a range of inflammation-based illnesses like arthritis, allergies and asthma. Some other research topics that have proved fruitful are indications that anthocyanins: reduce low density lipoprotein (LDL) in favor for high density lipoprotein (HDL) cholesterol^[18], could help in the treatment of cancer^[16a, 19] and might increase glutathione levels^[16b].

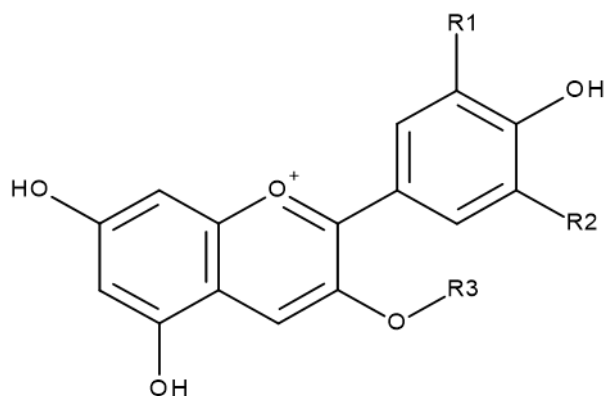

Figure 2. Anthocyanin backbone, where $R1$ and $R2$ are variable side chains like methoxy or other, and $R3$ is a sugar.

The Biolink group was the parent company of Medpallet, which extracts, packages and ships their flagship product Medox, anthocyanins extracted from bilberries. Just prior the start of this master project Medpallet was acquired by the German company Evonik and Biolink no longer hold the majority shares in the company. However, the Biolink group as the owners of Biosynth aim to produce a large quantity of a variety of anthocyanins for sale in the future.

1.3.2 Glycosides as antibiotics

Living organisms are separated into three main categories, three domain system, eukaryotic, archaea and bacteria. Bacteria and archaea are prokaryotic microorganisms and are the oldest, most abundant and diverse group in the three domain system^[20]. While most bacterial lifeforms are harmless to human beings, some are in fact necessary for our body to function optimally. Research on the human gastrointestinal (GI) tract shows that it would not function properly without bacterial microorganisms^[21]; newer research even suggests that our immune system^[22] and mental health^[23] is affected by this bacterial culture.

However, some bacteria have developed in such a way that they are harmful to us and cause disease (pathogenic). Throughout history and even today pathogenic bacteria remain one of the biggest threats to human health, and society as a whole.

In 1928 Alexander Flemming discovered a type of fungi that lived underground which showed fantastic abilities for curing bacterial infection, the fungi was the infamous penicillium fungus *Penicillium chrysogenum* and in 1942 people started using penicillin for bacterial infection^[24]. This was the first known antibiotic and revolutionized human health and medicine. Up until today antibiotics have been instrumental for human health worldwide, however some bacteria

have developed immunity towards several antibiotics and are again becoming a large threat to health^[25].

This has increased the need for research creating or discovering new candidates that may be useful as antibiotics or candidates that enhance the effectiveness of preexisting antibiotics. Currently we are working towards the effective production of even the rare antibiotics as well as limiting over usage of antibiotics in many parts of the world.

A new brand of antibiotics that are fairly narrow spectra are being researched in an attempt to have more specific treatment and in this way protecting the native bacteria in the body as well as avoiding immunization of the general bacterial populous; such an antibiotic is for example fidaxomicin which has proved effective at selectively eradicating *Clostridium Difficile*^[26].

Fidaxomicin

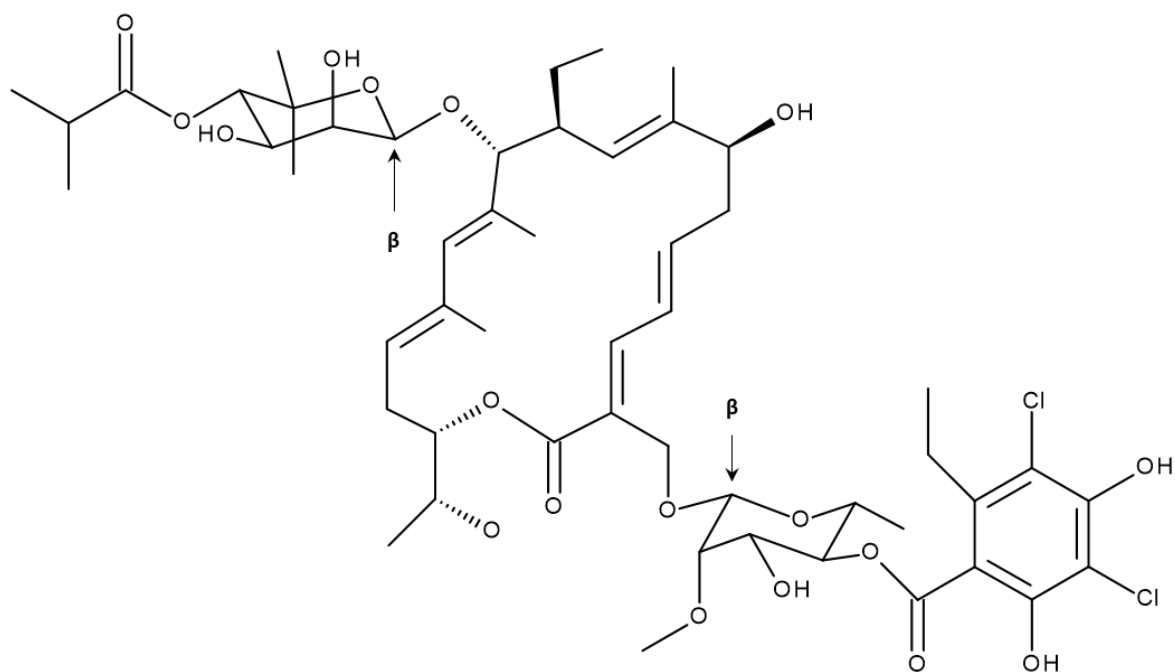

Figure 3. Fidaxomicin chemical structure, where the arrows denote what stereochemistry the glycosidic bond has.

Fidaxomicin is a narrow spectrum antibiotic that as mentioned earlier works well to treat *Clostridium Difficile*, a bacteria that is responsible for serious GI illness^[27]. Due to its chemical nature it is difficult to adsorb into the bloodstream, this increases its effectivity in eradicating the infection of *Clostridium Difficile*^[26]. Fidaxomicin is a product of fermentation of *Dactylosporangium aurantiacum subspecies hamdenesis*^[26], and was synthesized in its

entirety by Gademann, K^[28]. For glycosylation of the western sugar Helferich conditions (see Section 2.2.1) were employed yielding 63%, and for the eastern sugar they used a trifluoroacetamide (see Section 2.2.1) donor yielding approximately 62%^[28].

Fidaxomicin contains two equatorial O-glycosidic bonds connecting to the major body of the compound (see figure 3).

Teicoplanin

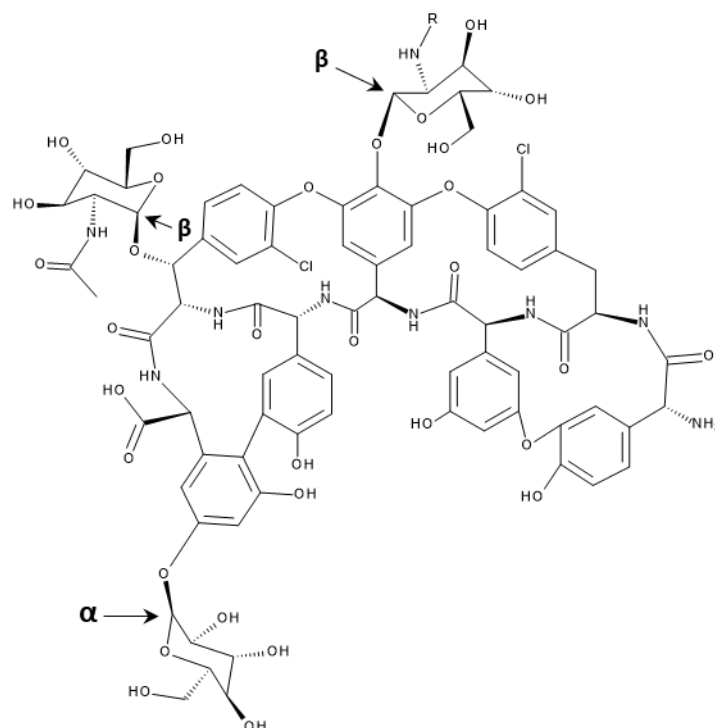

Figure 4. Teicoplanin (targocid) chemical structure where *R* is a variable known side chain, the arrows denoted what stereochemistry the glycosidic bond has.

Teicoplanin is a broad spectrum antibiotic that is especially well suited for getting rid of difficult gram positive infections^[29], it is produced in a fermentation of *Actinoplanes teichomyceticus*^[30]. Despite teicoplanin being expensive and hard to manufacture it is an important antibiotic used to treat people with serious gram-positive blood infections (sepsis). Attempts have been made to synthesize teicoplanin and in 2001 David Evans managed to synthesize the aglycone (without sugar)^[31].

Teicoplanin contains three O-glycosidic bonds where two are β -glucosamine and one is α -Mannose (see Figure 4).

1.3.3 Glycosides as antiparasitic drugs

Parasites are eukaryotic organisms that live and breed taking nutrition from its host and releasing potentially pathogenic side products or themselves behaving in such a way as to be pathogenic. Some well-known parasites are *plasmodium*, *oschocerca volvulus* and tapeworm. *Plasmodium falcipurum* is the deadliest parasite known to the modern age as it causes the condition malaria, malaria is such a proficient killer that it seriously affects the global statistic for life expectancy^[32].

Nematode parasites, tapeworms or *oschocerca volvulus*, live in the body until adulthood and then spreads either through eggs laid into stool or through escaping the body. River blindness is a condition caused by the parasite *oschocerca volvulus* and has its name from the nematodes moving to the eye and causing permanent visual impairment.

Ivermectin

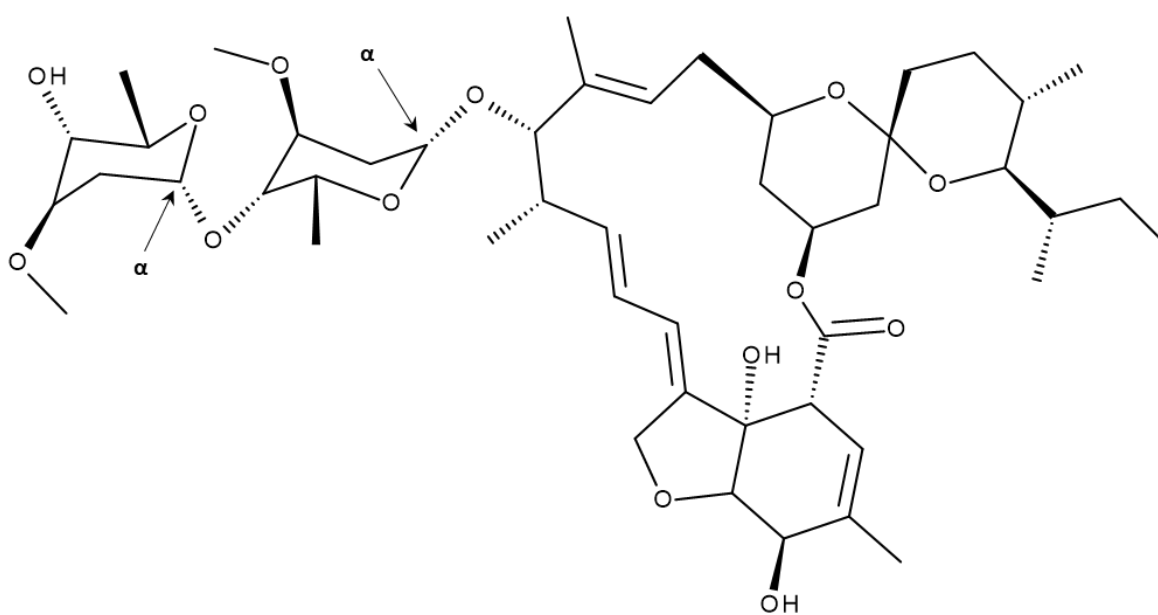

Figure 5. Ivermectin chemical structure, where the arrows denoted what stereochemistry the glycosidic bond has.

Ivermectin is the most widely used broad spectrum anti parasitic drug in the world today, being the typical treatment for nematode parasites^[33]. Ivermectin is a derivative of avermectin, a well-known natural anti parasitic drug^[34], and it was developed by Merck from the Japanese soil sample that contained avermectin^[35]. Ivermectin differs from avermectin in a single double bond on the spiroketal part of the molecule. The discovery of ivermectin and Avermectines was awarded with a Nobel prize in medicine that went to Campbell and Ōmura^[36]. Avermectines

have been synthesized by Danishefsky using NIS glycal reaction (see Section 2.2.1) for glycosylation getting 48%^[37], Hannesian using pyridilthioglycoside in the presence of silver triflate getting 40%^[38], and by Ley^[39] and White^[40] using similar methods to Hannesian.

Ivermectin is a semi-synthetic drug as it is a natural compound that goes through a chemical modification before it is sold. The drug contains a disaccharide connected by an axial O-glycosidic bond this disaccharide is also connected by an axial O-glycosidic bond to the main body of the chemical (see figure 5).

1.3.4 Glycosides in chemotherapy

Chemotherapy compounds can be used to control foreign bodies and kill them off in the body. Compounds that are useful in chemotherapy are toxic molecules that the body can survive but the foreign body has a weakened defense to. Typically, chemotherapy is used for cancer treatment and most well-known for this, however it has also traditionally been used as a cure for a myriad of other serious illnesses.

Bleomycin

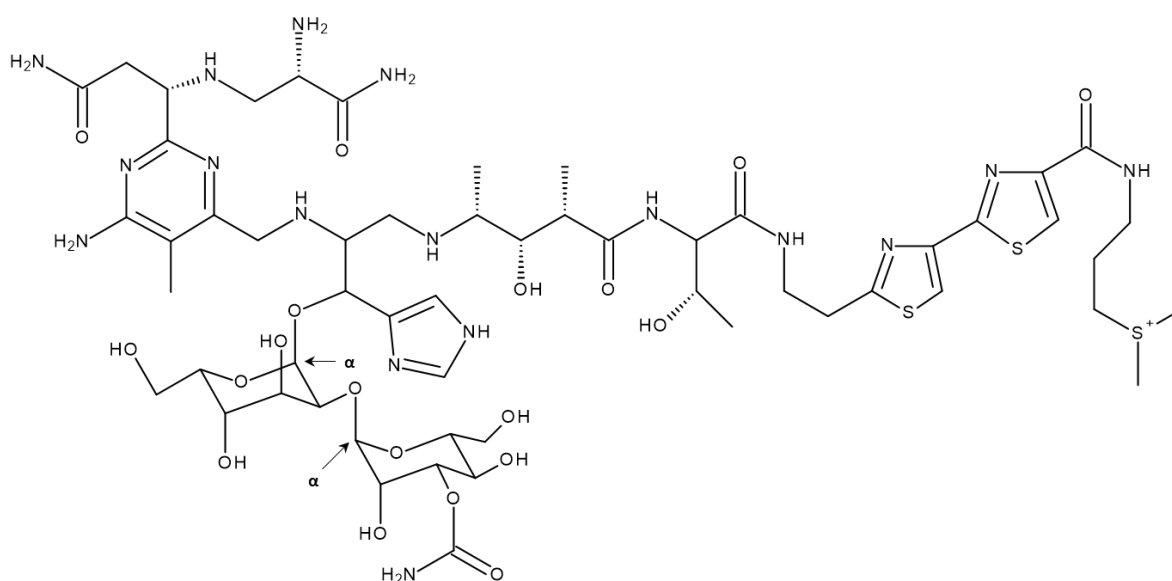

Figure 6. Bleomycin chemical structure, where the arrows denoted what stereochemistry the glycosidic bond has.

Isolated from *Streptomyces verticillus* in 1966 bleomycin was too toxic to be used as an antibiotic, however it showed promising anti-cancer activity and is used to cure several cancer types by preventing the synthesis of DNA in the cell^[41]. Bleomycin has been synthesized by several teams, notably Umezawa using Helferich conditions (See section 2.2.1) for

Anomeric O-Alkylation as a Diastereoselective Glycosylation Method

glycosylation^[42] and Hecht, S, M using glycosylation with gulopyranosyl chloride^[43].

Bleomycin contains a disaccharide connected by an α O-glycosidic bond and the disaccharide is connected by another α O-glycosidic bond to the main body of the chemical (see figure 6).

Capecitabine

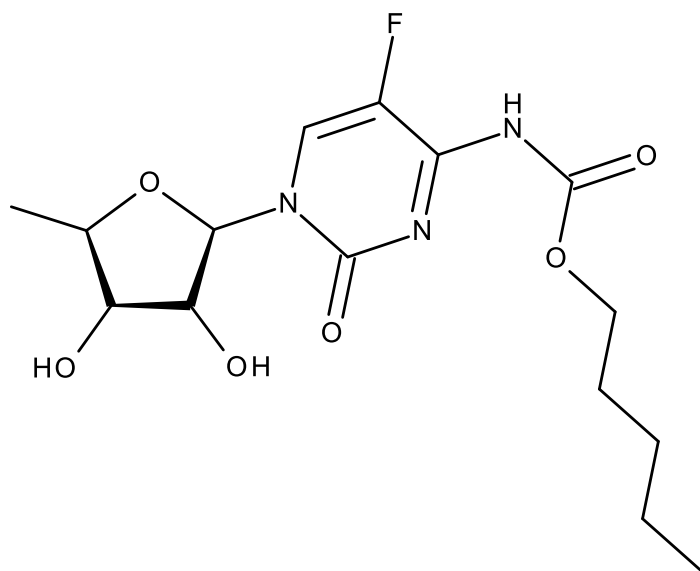

Figure 7. Capecitabine chemical structure, where the arrows denoted what stereochemistry the glycosidic bond has.

Fluoropyrimidine hinders synthesis of DNA in the cell this gives it powerful anti-cancer abilities, however by itself it is undirected and damages the body in general^[44]. Capecitabine is in a group of molecules that are metabolized to 5-fluoropyrimidine more readily in tumor cells^[45]. Capecitabine contains a variable side chain that can be used to direct activity a longer one will make it unpolar and keep it in the gut for GI cancer and a smaller side chain allows it to function well in the liver^[45]. The design and synthesis of capecitabine was published in 2000 by Shimma, N^[45]. The glycosylation was performed with a peracetylated 5-deoxyribose in the presence of a Lewis acid, SnCl_4 , and 5-fluorocytosine^[45]. Capecitabine contains a β -N-glycosidic bond connecting the furanose to the main body of the molecule (see figure 7).

1.4 Goals and Objectives

The method developed at the Biosynth lab have offered a highly diastereoselective glycosylation with Cs_2CO_3 in DMF giving mostly α , and NaH in DCM giving mostly β . Within this field most of the research at the Bakstad research group has been directed at the glycosylation of haloacetophenones (see Section 1.2). The full extent of what electrophiles can be directed using these conditions are unknown, while some research has been published using α -haloesters^[46] and the research made by the Bakstad research group.

- Investigate possible electrophiles for the anomeric O-alkylation
- Optimize yields and decrease side product formation
- Explore stereoselectivity of other electrophiles
- Find a cheap and easy synthesis of D-glucose-2,3,4,6-tetraacetate

2 Theory

2.1 Acidic α -halogenation of ketones

In strongly acidic environments the equilibrium of keto-enol tautomerization is pushed towards the production of more enol. The enol has an electron rich double bond that reacts with an electrophile, in this reaction it can only react with either H^+ or $X^{\delta+}$. If the enol reacts with the H^+ it simple goes through tautomerization back to its keto form and if it reacts with $X^{\delta+}$ it will become an α -halogenatedketone^[47]. For each α halogen the reaction is harder due to a decreased production of enol, this limits the formation of side products.

However using a surplus of X^{δ} one can replace more than one α hydrogens and make poly halogenated reactants^[47] giving a small amount of side products.

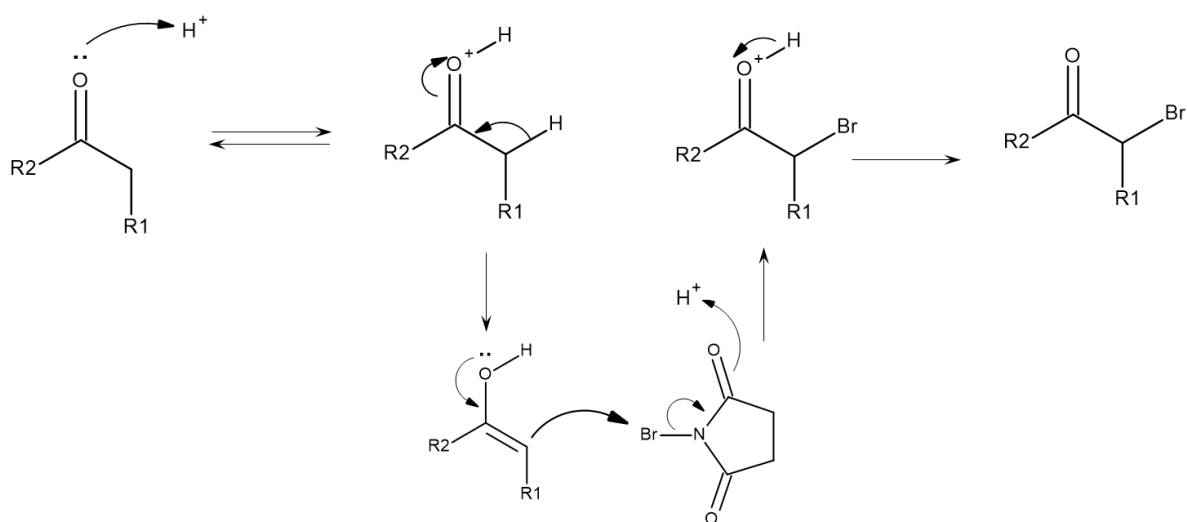

Scheme 2. Proposed reaction mechanism for making halogenated ketones.

2.2 Glycosylation

Sugar molecules are a group of biologically active molecules that are important both for energy and as components in many natural compounds as was discussed in the introduction. Glycosylation are reactions where a sugar molecule is connected to another molecule. There are several different types of glycosylation products based on what nucleophile is reacted with the anomeric carbon: O-glycoside, N-glycoside, S-glycoside and C-glycoside.

2.2.1 Glycosylation using electrophilic sugar

Koenigs-Knorr glycosylation

Koenigs-Knorr glycosylation is a method of glycosylation published in 1901^[48], by Koenigs and Knorr. Standard Koenigs-Knorr uses silver salts to facilitate substitution reaction that replaces a halogen group with a nucleophile to produce a glycoside^[48-49].

As a heavy metal is added to the reaction mixture a stabilized carbocation is generated by the formation of insoluble metal halide salts^[49], this pushes the equilibrium of carbocation to halogenated sugar towards the cation. Carbocations themselves are non-stereo selective so the Koenigs-Knorr method uses a neighboring group effect to make an intermediary stage which directs the stereoselectivity (see Scheme 3). Normally the neighboring group is an acetyl group as this forms a stable resonance structure, other groups containing carbonyls like benzoyl groups work as well, this resonance structure guides the nucleophile to attack equatorially. The drawback of this reaction is the price. The use of other heavy metals than silver have proven to be effective (Helferich conditions)^[50] but they are significantly more toxic.

Other neighboring groups not containing carbonyls may yield different stereospecificity, but the reaction is mostly used for the creation of equatorially glycosides^[48].

Anomeric O-Alkylation as a Diastereoselective Glycosylation Method

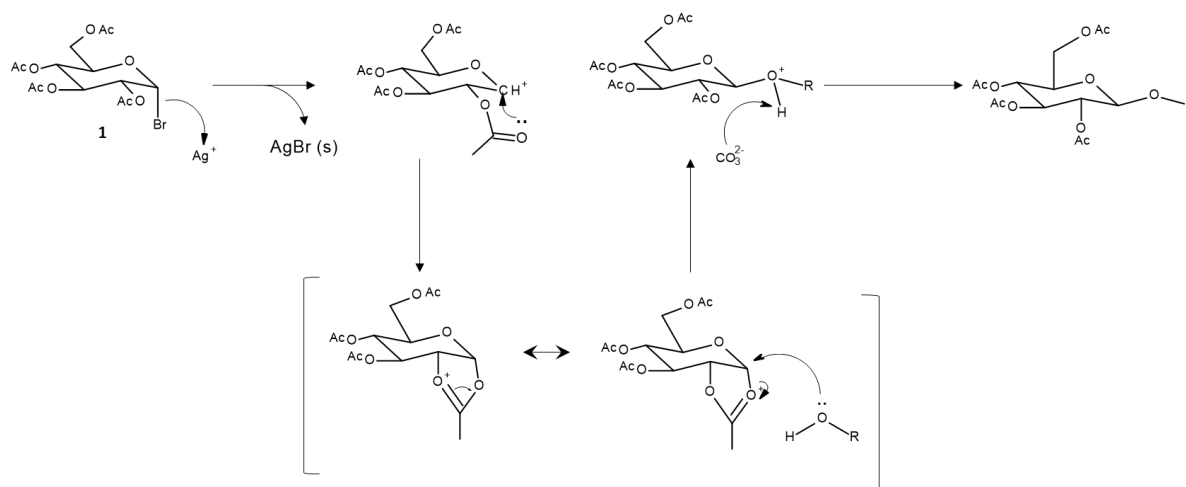

Scheme 3. Proposed mechanism for the Koenigs-Knorr reaction.

Schmidt glycosylation

Schmidt glycosylation was developed by Schmidt et al in 1980 as a stereo selective glycosylation that replaces a leaving group, specifically trichloro or trifluoroacetamide, with a nucleophile.

Schmidt used trichloroacetonitrile^[51] in a reaction with a protected sugar to make an O-glycoside with trichloroacetonitrile (see Scheme 4). This glycoside is known as the Schmidt reagent. The Schmidt reagent is susceptible to nucleophilic attack in an $\text{S}_{\text{N}}2$ and $\text{S}_{\text{N}}1$ type reaction depending on the conditions. This reaction gives a glycoside and releases trichloroacetamide as its leaving group^[52], the resulting trichloroacetamide then decomposes to the corresponding trichloroacetamide.

Standard Schmidt glycosylation is catalyzed with a Lewis acid, typically $\text{BF}_3 \cdot \text{Et}_2\text{O}$ ^[53], that promotes an $\text{S}_{\text{N}}1$ pathway where the trichloroacetamide leaves prior to nucleophilic attack, this will like Koenigs-Knorr be directed according to the neighboring group (see Scheme 3).

Several similar leaving groups have been researched and many reaction conditions have been proposed to give a better yield of one diastereomer over another. Schmidt glycosylation is one of the most widely used forms of glycosylation due to its versatility.

However in order to achieve high yields the reaction requires dry conditions both under storage, production and use of the Schmidt reagent as it is susceptible to nucleophilic attack by water^[54].

Anomeric O-Alkylation as a Diastereoselective Glycosylation Method

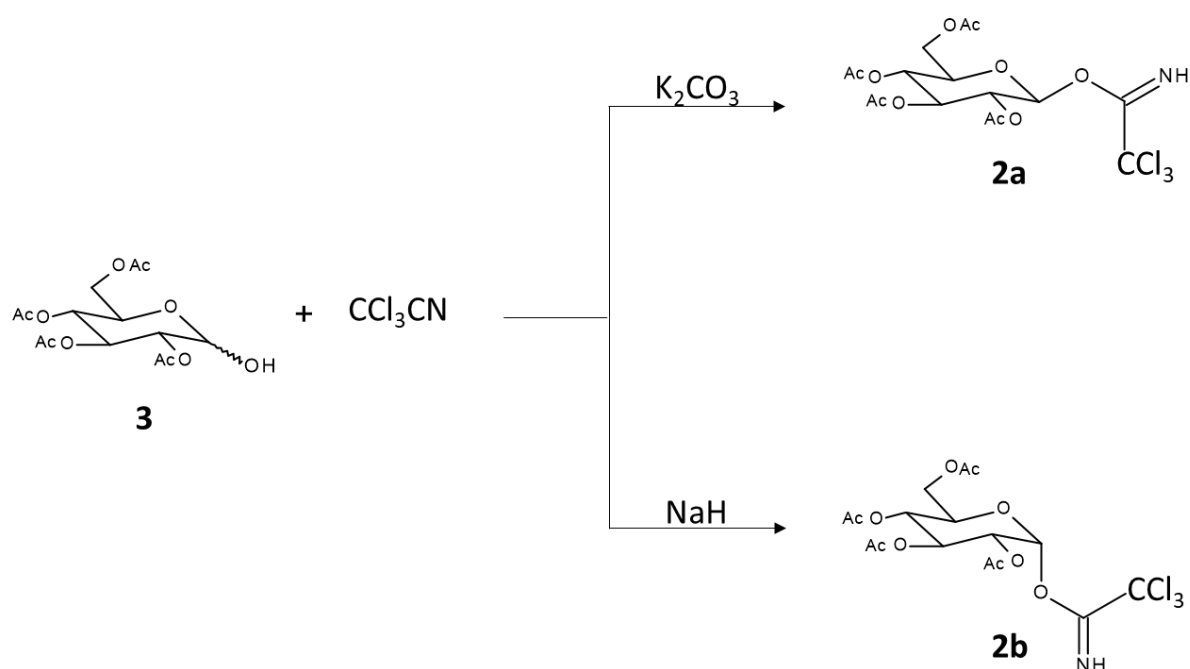

Scheme 4. Simple scheme for the creation of the Schmidt reagent.

The creation of the Schmidt reagent is done by reacting **3** with the acetonitrile using a base. Many attempts have been made to tweak reaction conditions to produce cleaner α or β Schmidt reagent. Generally one uses K_2CO_3 ^[7] in order to achieve β -enriched and NaH to achieve α -enriched^[7, 54], the guiding factors to which diastereoisomer being formed seems to be how strong the base is.

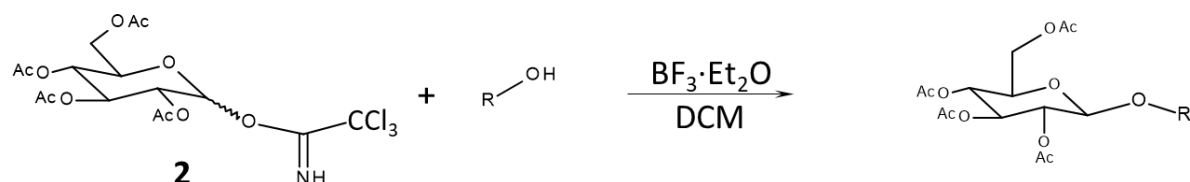

Scheme 5. General scheme of Schmidt glycosylation.

Many leaving groups have been investigated in glycosylation to have better stereo selectivity or yields than the aforementioned leaving groups.

Often a different leaving group could be preferred to avoid other incompatibilities with reactant and some predate the Schmidt reagent.

Other leaving groups include but are not limited to: triflateglycosides^[55], thioglycosides^[56], thioimidates^[57], *N*-pentenyl^[58] and propargyl^[59].

Glycal facilitated glycosylation

Originally described and created by Fischer glycals were thought to be an aldehyde of glucose however it was later discovered to be an unsaturated sugar with a double bond at the C1-C2 carbon^[60].

In the glycal reaction one produces a reactive sugar with a double bond using harsh conditions as an intermediate in glycosylation. This sugar is very reactive as it is unable to assume the proper chair conformation and has to assume a half chair conformation^[61].

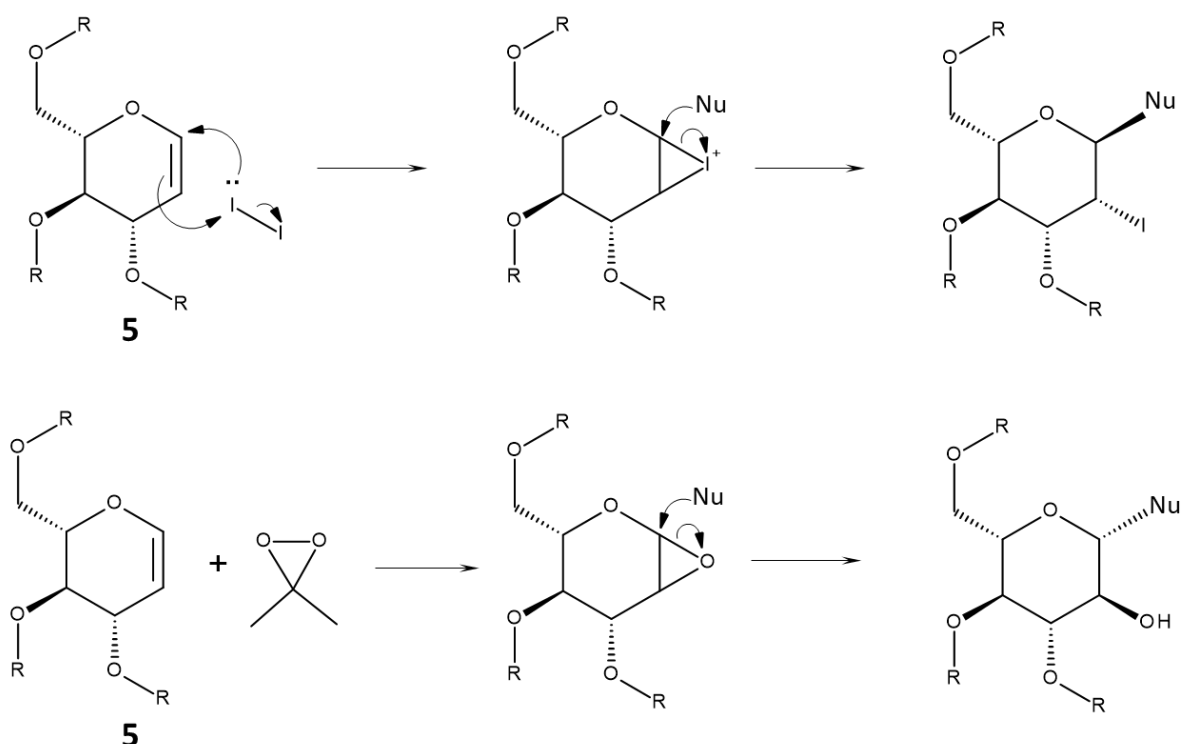

Scheme 6. Proposed reaction mechanism of 1) glycal iodine reaction and 2) epoxide glycal reaction, where the R group is a variable protective group.

Epoxidation of sugar is done by reacting the glycal with a peroxide the resulting epoxide is reacted with a nucleophile to form a glycoside, this method is often accredited to the chemist Danishefky as he popularized this method in his publication^[62] but one of the first was Brigl in 1920^[63]. It was discovered that epoxide glycal could be guided towards α or β -glycosylation by carefully picking peroxide and protective groups^[62, 64], dimethyldioxirane (DMDO) gave α epoxidation and β glycosylation^[62].

Glycal can also be reacted with I₂, where the iodine reacts with the double bond to create an iodonium cation which is a powerful electrophile attacked by a nucleophile on the anomeric carbon. Iodonium glucose was observed to react favorably to form α -glycosides under the

conditions tested^[64-65]. The resulting product can be reacted with another nucleophile to remove the C3 iodine and replace it with a nucleophile for example, hydroxide to give C1 substituted D-glucose. This reaction was first developed using NIS as the source of I⁺ by Lemieux^[65a] and later popularized by Danishefsky^[62, 64]

2.2.2 Glycosylation using nucleophilic sugar

Anomeric O-alkylation using primary electrophiles

Anomeric O-alkylation is a method that the Bakstad research group has used to successfully synthesize anthocyanins. Anomeric O-alkylation uses solvent traits to ensure one specific diastereoisomer is the major product. The extent of anomeric O-alkylation was first explored by Schmidt^[7, 52-54] in 1980. In 2001 anomeric O-alkylation of glucosamine was shown in DMF^[66] and was then further explored by the Bakstad research group.

After the Bakstad research group began the research some new additions to anomeric O-alkylation was done on α -haloesters^[46].

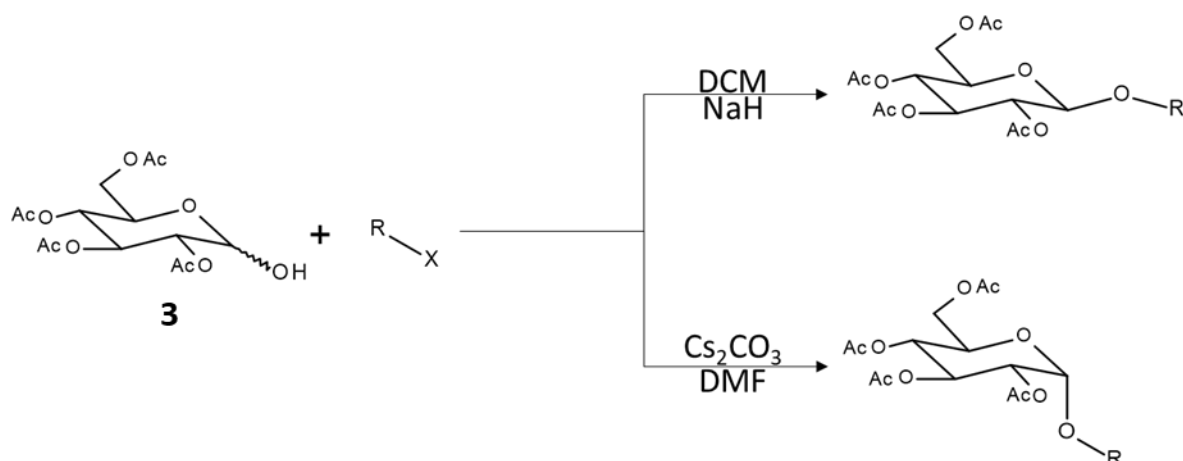

Scheme 7. Simple overview of anomeric O-alkylation.

During the synthesis of anthocyanins, the Bakstad research group made some discoveries which indicated the significance of solvent on anomeric O-alkylation and stereoselectivity. Employing DCM (solvent) and NaH (base) was found to yield nearly pure β -glycosides.

Interested continuing to develop this method different solvents and conditions were investigated and it was discovered that by employing DMF (solvent) and Cs₂CO₃ (base) the result was enriched in α -glycosides.

Anomeric O-Alkylation as a Diastereoselective Glycosylation Method

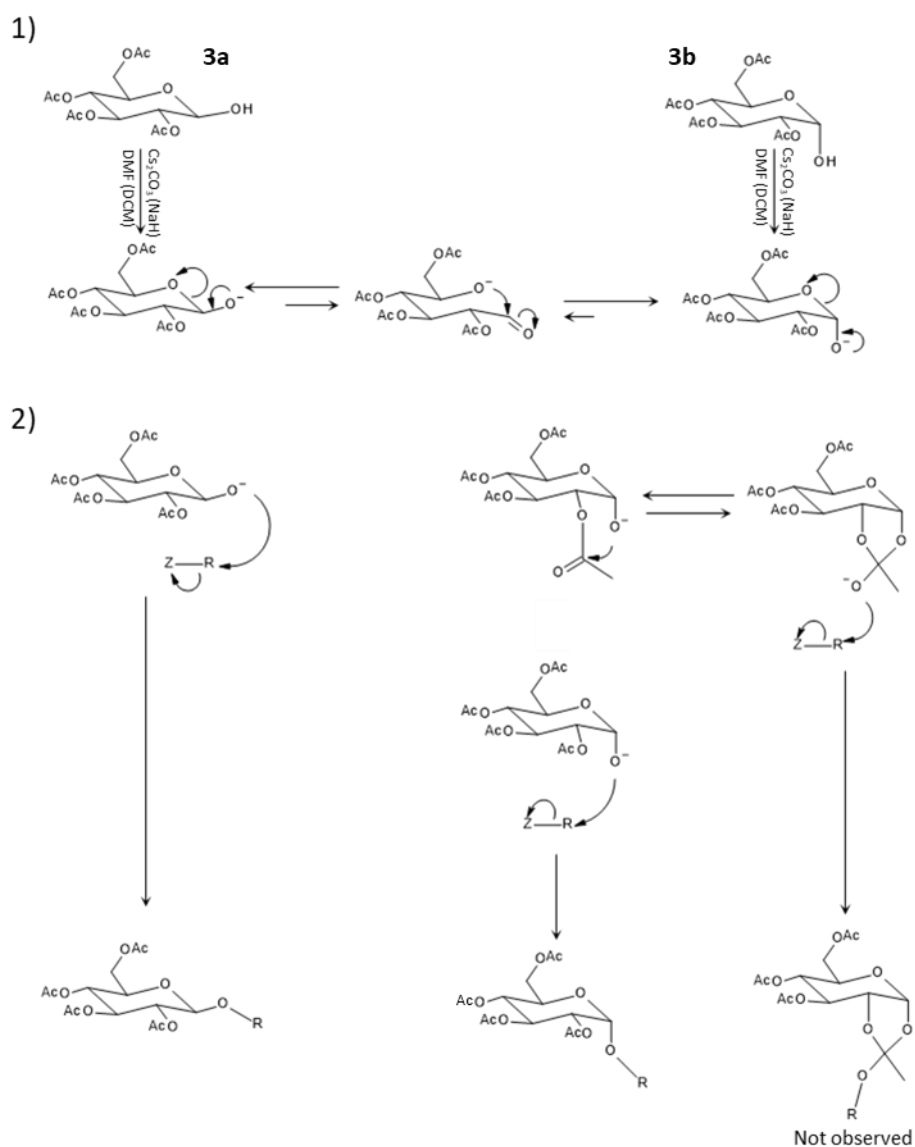

Scheme 8. Full overview of the proposed mechanism of the anomeric O-alkylation. 1) shows mutarotation in solvent and 2) shows reaction pathway to Beta (left) and Alpha (right) where the left is favored in DCM and the right is favored in DMF.

Many different bases have been attempted to deprotonated **3** and surprisingly weak bases have shown the ability to do so^[67], pK_a of **3** has been discussed widely and ranges have been given from pK_a at around 12^[68] all the way to a pK_a at around 14^[69]. The low pK_a observed from D-glucose is most likely a result from the delocalized electrons (see Scheme 8)

Polar solvents like DMF stabilize charged species better than unpolar solvents this helps facilitate the isomerization from the kinetically favorable β -D-Glucose-2,3,4,6-tetraacetate (**3a**) to the more thermodynamically favorable α -D-Glucose-2,3,4,6-tetraacetate (**3b**), given by the anomer effect as well as the neighboring group effect with carbonyl containing protective

groups. Consequently, this creates more of **3b** to react with the given electrophile and gives a stereoselective reaction.

In DCM the charged sugar is not as stabilized, and the result is less isomerization to **3b**. Reduced isomerization in combination with the increased nucleophilicity of **3a** favors the formation of the β -glycoside.

This approach differs from other glycosylation methods as it uses an electrophile to react with sugar instead of a nucleophile, giving a broad range of new opportunities for synthons and their corresponding chemical equivalents in the retrosynthetic model.

Glycosylation of Michael acceptors

Michael acceptors are α - β -unsaturated compounds that receive electron pairs and create a bond. Generally, Michael acceptors are uncharged in their native state and fall into the category of soft electrophiles. In a Michael addition one requires a small homo-lumo gap this means soft nucleophiles are reacted with soft electrophiles or hard with hard to attain the best results. With the anomeric hydroxy group of glucose this is hard to achieve, however the electrophile could be further polarized using a Lewis acid and increasing reactivity of the electrophile.

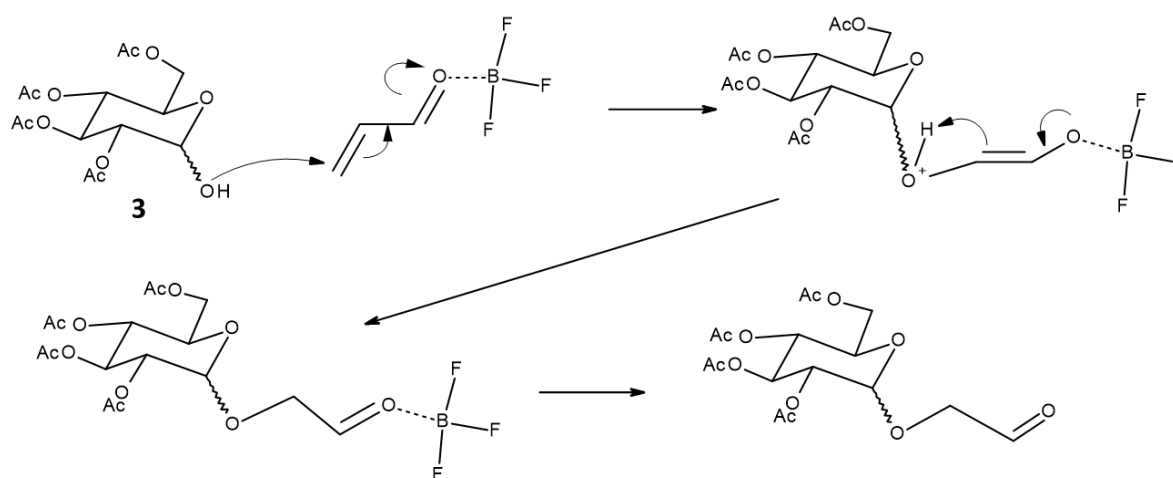

Scheme 9. Proposed reaction mechanism of Michael addition using D-glucose as Michael donor where the reaction with acrolein was used as an example.

2.3 Solvent effects

Solvents are often categorized from two properties polarity and ability to donate, receive or be unaffected by H⁺.

These properties are often attributed to what reaction takes place, for example when determining if a reaction is likely to undergo SN1, SN2, E1 or E2 as its main reaction mechanism. This often comes as a side effect of what intermediates are stabilized in which solvents. Reaction mechanism for secondary electrophiles are often entirely determined by solvent chosen for the given experiment, as it is able to be directed towards SN1 or SN2. However secondary and tertiary electrophiles are also capable of E1 or E2 reactions, this will also be highly affected by solvent and conditions.

A solution of **3a** in a highly polar solvent increases the stability of the charged anomeric oxygen and allows for mutarotation where the outcome is an increased amount of **3b**.

On **3** acetyl groups can help stabilize a negative charge in the axial position as it can undergo nucleophilic addition to the carbonyl and produce the corresponding ortho ester.

A higher polarity solvent gives higher α/β ratio seemingly directed by: the anomer effect, higher amount of isomerization and the neighboring group effect. Whilst more unpolar solvents yield little isomerization and subsequently a smaller α/β ratio.

3 Results and discussion

3.1 Production of α and β anomeric hemiacetal sugar

Production of relatively pure β -D-glucose-2,3,4,6-tetraacetate (**3a**) was achieved with standard Koenigs-knorr conditions set by Chester, M^[70] employed on α -Bromo-D-glucose-2,3,4,6-tetraacetate (**1**). α -Bromo-D-Glucose-2,3,4,6-tetraacetate (**1**) was dissolved in acetone cooled in an ice bath, afterwards a stoichiometric amount of water was added and Ag_2CO_3 to initiate the reaction. The reaction mixture was then removed from the ice bath and allowed to reach room temperature (R.T.). The classic Koenigs-Knorr on acetyl protected sugar allowed for mostly equatorial nucleophilic attack giving **3a** as the major product with some traces of α -D-Glucose-2,3,4,6-tetraacetate (**3b**).

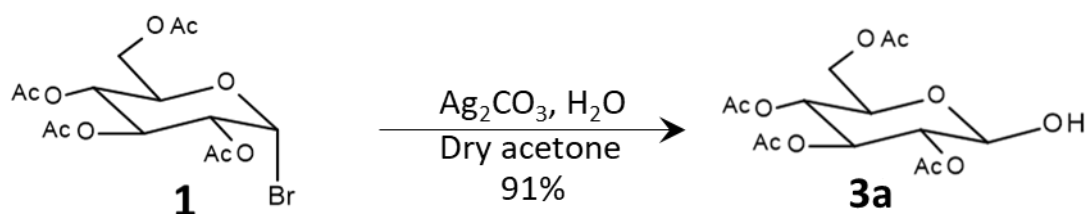

Scheme 10. Koenigs-Knorr production of β -D-Glucose-2,3,4,6-tetraacetate (**3a**).

For production of **3b** a method with peracetylated D-glucose and ammonium acetate (NH_4OAc) in DMSO, DME or DMF was employed. This gave yields at around 70% α enriched **3** in a ratio which ranged from 70/30 and 60/40 in terms of α/β .

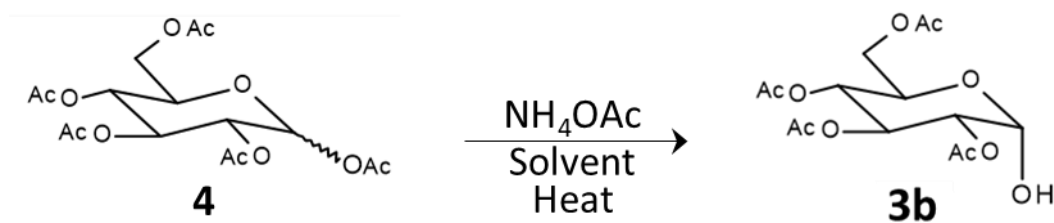

Scheme 11. Production of α -D-Glucose-2,3,4,6-tetraacetate (**3b**) by D-Glucose-1,2,3,4,6-pentaacetate (**4**).

This reaction was attempted with several solvents to investigate which solvent would give best yields or higher alpha selectivity.

Anomeric O-Alkylation as a Diastereoselective Glycosylation Method

Table 2. Table of solvents, yields and ratio using α or β peracetylated D-glucose with NH_4OAc to produce α -D-Glucose-2,3,4,6-tetraacetate (**3b**).

| Solvent | Heat | Yield | α (%) |
|--------------|--------|--------|--------------|
| DME | Reflux | 70% | 70% |
| DMSO | 40 °C | 80% | 70% |
| DMF | 70 °C | 70% | 70% |
| THF | Reflux | Traces | N/A |
| Acetonitrile | Reflux | 60% | 60% |

Even though the yield and stereoselectivity of the reaction was good (see Table 2), other reactions were investigated for even higher stereoselectivity or yield.

A reaction using ammonia as reactant to deacetylate peracetylated glucose to tetraacetylated glucose was attempted, this was performed as described by Fiandor. J^[71], with one a notable alteration that ammonia was generated *in situ* and not from gas cylinder.

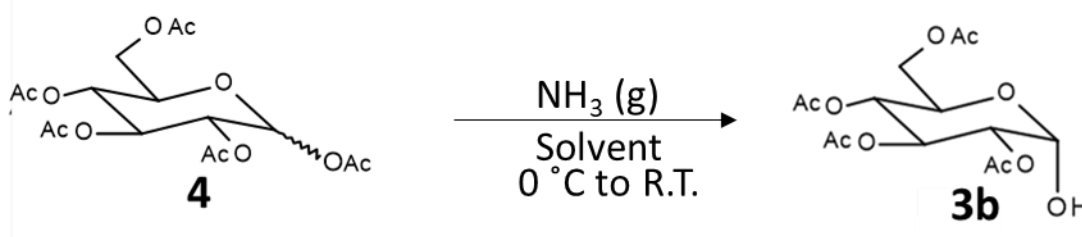

Scheme 12. production of α -D-Glucose-2,3,4,6-tetraacetate (**2b**) with ammonia.

With no purification beyond extraction, the product appeared as α enriched **3** as a viscous oil with a ratio of 75% α and 25% β . The reaction in MeCN proved difficult to scale up beyond 0.1 mol, however the same reaction conditions were repeated in DMF at a scale of 0.3 mol to give a yield of 91% and reduced reaction time.

Table 3. Table of solvents and corresponding Yield(%)[2].

| Solvent | Yield |
|---------|-------|
| MeCN | 85% |
| DMF | 91% |

3.2 Preparation of α -haloketones

Acidic halogenation of haloketones was performed in accordance with literature^[47] however with a small modification that was discovered by the Bakstad research group of dissolving NBS with the ketone in DME. A solution *p*-TsOH dissolved in acetonitrile was added dropwise to the solution of NBS and ketone in DME .

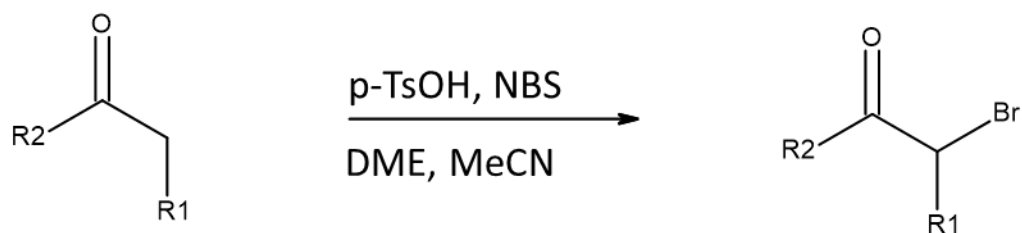

Scheme 13. Bromination of ketones

Bromination of smaller cycloalkanones yielded somewhat unstable liquids and had to be stored at subzero temperatures and even then had to be used within a short amount of time, this was also observed by another group^[72]. However, the larger α -bromocyclododecanone (**10b**) was stable, this was attributed to the fact that **10b** was a solid; solid α -haloketones have been found to be remarkably stable.

Anomeric O-Alkylation as a Diastereoselective Glycosylation Method

Table 3. Table of halogenated ketones

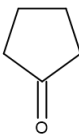
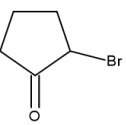
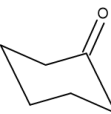
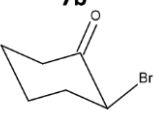
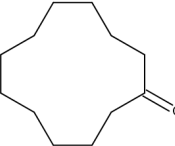
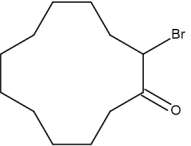
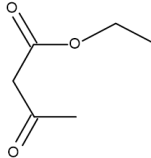
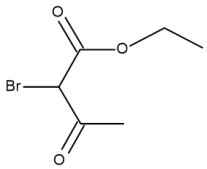
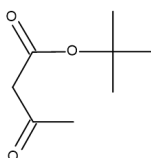
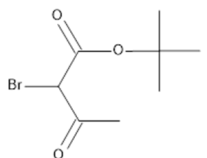
| Reactant | Product | Yield | Side product |
|--|--|-------|--------------------|
| 6a  | 6b  | 86% | Non- discovered |
| 7a  | 7b  | 91% | Non- discovered |
| 10a  | 10b  | 90% | Non- discovered |
| 8a  | 8b  | 86% | Non- discovered |
| 9a  | 9b  | 92% | Non- discovered |

3.3 Glycosidation

3.3.1 Investigation considering the formation of peracetylated glucose

All experiments with new electrophiles were conducted at R.T., in these reactions a side product was always α and β peracetylated glucose.

Experiments were conducted using different amounts of base, a slower addition of base as well as temperature control. Reactions were conducted on 2-iodo-1-(2,2-diphenyl-1,3-benzodioxol-5-yl)ethanone (**20**) and **3**, using NaH or CsCO₃ as base and DMF or DCM as solvent.

Experiments conducted where base was added in one go increased quantity of peracetylated side product, and experiments where base was added in portions over a period of fifteen minutes decreased the amount of peracetylated product. The effect on the reaction was drastically different for NaH and Cs₂CO₃ where NaH showed clear improvements and Cs₂CO₃ showed some rudimentary improvement with slower addition.

As for the amount of base quantities were attempted: 0.75, 1, 1.25, 1.5 and 2 equivalents. Around 1.25 equivalents of NaH was found to yield as little peracetylated product possible at the same time as it gave good yields of glycoside, and 1.5 equivalents was found to be optimal for Cs₂CO₃ however 1.25 equivalents was only slightly worse.

Temperature experiments were done at R.T., ice bath (4°C), and ice bath with salt (0°C). In all cases after addition of base the reaction mixture was removed from ice bath and allowed to reach R.T. over time, the results of this was a significant reduction in peracetylated glucose.

Best results were achieved using 1.25 equivalents of base (NaH or Cs₂CO₃) added over fifteen minutes, with the reaction flask cooled in an ice bath.

In many cases these conditions gave a complete absence of peracetylated glucose, this meant it was easier to isolate the product and the reaction gave higher yields.

3.3.2 α -glycosides

The α -glycosylated products were made using Cs₂CO₃ as base and DMF as solvent. Flash chromatography was used to ensure pure product for NMR.

Overview of α -glycosylation attempts

Table 4. α glycosylated products with yields and stereochemical ratio.

| Electrophile | | Product | α | Yield | Side product |
|--|----|------------|-----------------|--------|--------------|
| <i>tert</i> -Butyl bromoacetoacetate (9b) | 2- | 31a | $\approx 100\%$ | 51% | (4) |
| Benzyl bromoacetate (16) | | 29a | 87% | 39% | (4) |
| α -Bromocyclohexanone (7b) | | 25a | $\approx 100\%$ | 35% | (4) |
| Iodoacetonitrile (14b) | | 27a | 81 % | 24% | (4) |
| Ethyl bromoacetate (12) | | 28a | 89% | 22% | (4) |
| 2,3-Dibromopropene | | 33 | 75% | 9% | (4) |
| α,α -Dichlorodiphenylmethane (11) | | None | N/A | traces | (4) |
| Benzyl iodide (17c) | | None | N/A | traces | (4) |
| <i>N,N</i> -Diethyl chloroacetamide (13) | 2- | None | N/A | N/A | (4) |
| α -Bromocyclododecanone (10b) | | None | N/A | N/A | (4) |
| α -Bromocyclopentanone (6b) | | None | N/A | N/A | (4) |
| Bromotriphenylmethane (15) | | None | N/A | N/A | (4) |

To a dry and cooled solution of **3** and electrophile was added, when both were sufficiently dissolved Cs₂CO₃ or DBU was added over a period of fifteen minutes. After the addition of base, the ice bath was removed, and the reaction was allowed to reach R.T. and left to react overnight.

Glycosylation functioned at varying degrees giving yields of 9-51%, and in some cases getting exclusively α -glycoside.

α -Bromocyclohexanone (7b), α -bromocyclopentanone (6b) and α -bromocyclododecanone (10b) in DMF

α -Bromocyclohexanone (**7b**), α -bromocyclopentanone (**6b**) and **12b** were attempted as electrophiles in the anomeric O-alkylation in DMF. Interestingly the only one of the three compounds to give any glycoside was **7b**. Diagnostic peaks at around 160-170 in ^{13}C NMR indicated that a competing Favorskii rearrangement could potentially explain the results obtained in DMF.

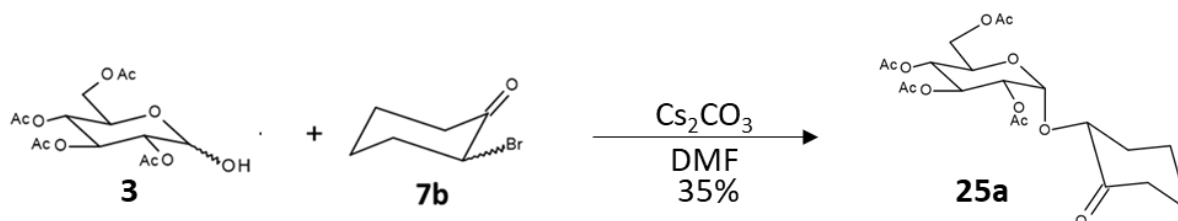

Scheme 14. Production of 2-(2,3,4,6-tetra-O-acetyl- α -D-glycopyranosyloxy)cyclohexanone (25a).

Giving 35% yield **7b** reacted with **3** to form 2-(2,3,4,6-tetra-O-acetyl- α -D-glycopyranosyloxy)cyclohexanone (**25**) of nearly exclusively one diastereoisomer.

DMF is a polar aprotic solvent this could push the reaction towards a $\text{S}_{\text{N}}1$ type reaction instead of an $\text{S}_{\text{N}}2$ type giving the observed effect of only one diastereoisomer.

Acetoacetic esters in glycosylation

Initially the idea was that with acetoacetic esters one could in theory have a variable R-group and create interesting glycoside. Another interesting note was the observed effect that carbonyl groups have a positive effect on glycosylation.

Surprisingly when *tert*-Butyl 2-bromoacetoacetate (**9b**) was used as an electrophile it produced the α -glycoside in DCM, which was indicated by both ^1H and ^{13}C NMR.

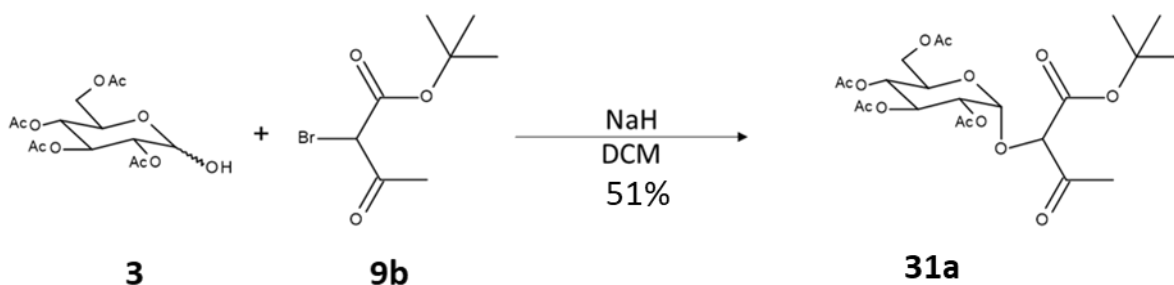

Scheme 15. Production of tert-Butyl 2-(2,3,4,6-tetra-O-acetyl- α -D-glucopyranosyloxy)acetoacetate (31a).

Prior to the reaction with **9b** anomeric O-alkylation was attempted on Ethyl 2-bromoacetoacetate (**8b**). The success of this reaction led to the decision to instead use a *tert*-butyl ester. The change to a *tert*-butyl ester as these esters undergo acidic hydrolysis under quite mild conditions. Mild conditions were preferred as this was meant to leave the acetyl groups untouched.

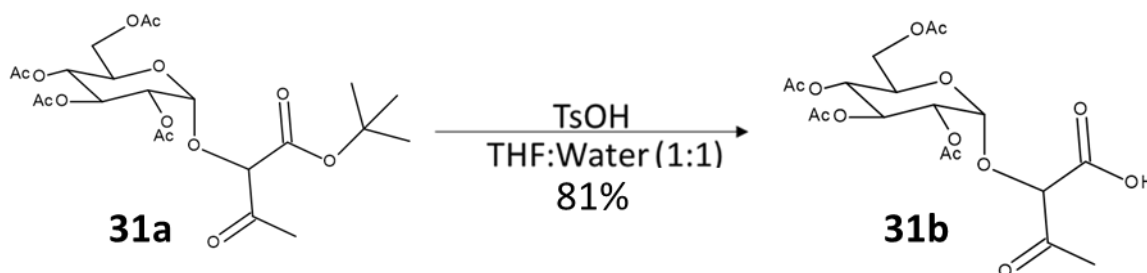

Scheme 16. Hydrolysis of 31a to 2-(2,3,4,6-tetra-O-acetyl- α -D-glucopyranosyloxy)acetoacetic acid (31b).

Hydrolysis of **31a** was quite successful and the reaction proceeded in high yields (81%) and with no identified side product besides *tert*-butanol.

The corresponding carboxylic acid was then used in an attempt to decarboxylate the glycoside.

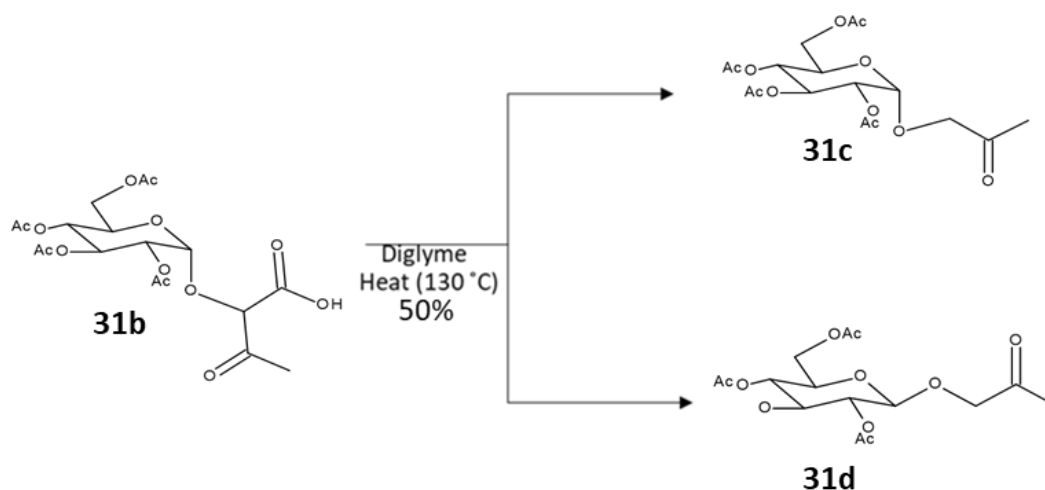

*Scheme 17. Decarboxylation of **31b** to 1-(2,3,4,6-tetra-O-acetyl- α -D-glucopyranosyloxy)propanone (**31c**) and 1-(2,3,4,6-tetra-O-acetyl- β -D-glucopyranosyloxy)propanone (**31d**).*

Decarboxylation worked to a varying degree at 130 °C but however gave both diastereoisomers and low yields (50%) of the corresponding glycosides. Although this reaction did not prove to be as effective as was initially hoped it could perhaps be improved.

Glycosylation of 2,3-dibromopropene (**24**)

Inspired by the work of (B.Sc.) student Katja Håheim where she attempted glycosylation with allyl bromide and no glycoside was produced. An experiment was performed with 2,3-dibromopropene (**24**) to see if this compound would yield similar results to allyl bromide.

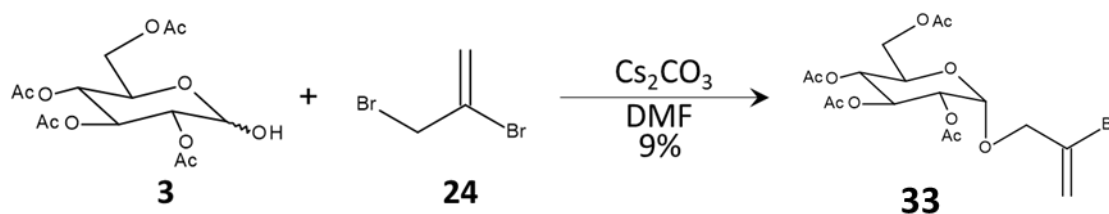

*Scheme 18. Glycosylation of 2,3-dibromopropene (**24**).*

Results of the reaction were low stereoselectivity and low yields of glycoside when it was attempted in DMF but no reaction was observed in DCM.

3.3.3 β -glycosides

The β -glycosylated products were made using NaH as base and DCM as solvent. Flash chromatography was used to ensure pure product for NMR.

Table 5. β -glycosylated products with yield and stereochemical ratio.

| Electrophile | Product | β | Yield | Side product |
|---|------------|-----------------|--------|--------------|
| α -Bromocyclododecanone (10b) | 32 | $\approx 100\%$ | 50% | (4) |
| Iodoacetonitrile (14b) | 27b | $\approx 100\%$ | 31% | (4) |
| Bromotriphenylmethane (15) | 30 | $\approx 100\%$ | 30% | (4) |
| Ethyl bromoacetate (12) | 28b | $\approx 100\%$ | 30% | (4) |
| α -Bromocyclopentanone (6b) | 26 | $\approx 100\%$ | 29% | (4) |
| Benzyl bromoacetate (16) | 29b | $\approx 100\%$ | 27% | (4) |
| α -Bromocyclohexanone (7b) | None | N/A | traces | (4) |
| Dichlorodiphenylmethane (11) | None | N/A | traces | (4) |
| <i>N,N</i> -Diethyl chloroacetamide (13) | 2- None | N/A | N/A | (4) |
| Benzyl iodide (17c) | None | N/A | N/A | (4) |
| 2,3-Dibromopropene | None | N/A | N/A | (4) |
| <i>tert</i> -Butyl bromoacetate | 2- None | N/A | N/A | (4) |

To a dry and cooled solution of **3** an electrophile was added, when both were sufficiently dissolved NaH was added over a period of fifteen minutes.

After the addition of base, the ice bath was removed, the reaction was allowed to reach R.T. and left to react overnight.

Glycosylation was highly dependent on electrophile used and gave yields of 27-50% and was highly stereoselective.

Improving yields and haloacetamides in anomeric O-alkylation

Previous student Katja Håheim attempted glycosylation using chloroacetamide this reaction was referenced as an oddity and Katja theorized that the lack of reaction could be attributed to the hydrogens on the acetamide^[73]. In order to test the hypothesis of Katja *N,N*-Diethyl 2-chloroacetamide (**13**) was attempted as an electrophile in the anomeric O-alkylation. Reaction with **13** also failed to give any glycoside. Even when **13** was attempted directly after a Finklestein halogen exchange using NaI no reaction was observed. The results of this seemed to indicate that another reason was to blame for acetamides being unreactive in the anomeric O-alkylation.

Reactions with ethyl bromoacetate (**12**) and benzyl bromoacetate (**16**) were reinvestigated as the yields reported by B.Sc. Katja were from a reaction in MeCN instead of DCM. MeCN was used in place of DCM as the reaction in DCM gave rampant formation of pentaacetate and low yields of glycoside.

Yields were improved from 4% to 30% for **28b** and from 3% to 27% for **29b**, these improvements came as a result of reduced peracetylated product in DCM using conditions described above, as well as a new solvent system for FC.

Reaction with iodoacetonitrile (**14b**)

Much of Schmidt's research was with trichloroacetonitrile as well as some other nitriles, chloroacetonitrile (**14a**)^[74].

Schmidt's work inspired us to attempt a stereoselective glycosylation with acetonitrile to see if we could synthesize the α and β glycoside of acetonitrile selectively.

Another inspiration for attempting this reaction was Fischer's synthesis of the β -glycoside of acetonitrile which gave a mixture of the two diastereoisomers^[75].

Chloroacetonitrile (**14a**) was first attempted as electrophile and gave a weak signal of glycosylation. Based on the results achieved using **14a** the reaction was repeated with iodoacetonitrile (**14b**) as this was thought to improve the yield.

Anomeric O-Alkylation as a Diastereoselective Glycosylation Method

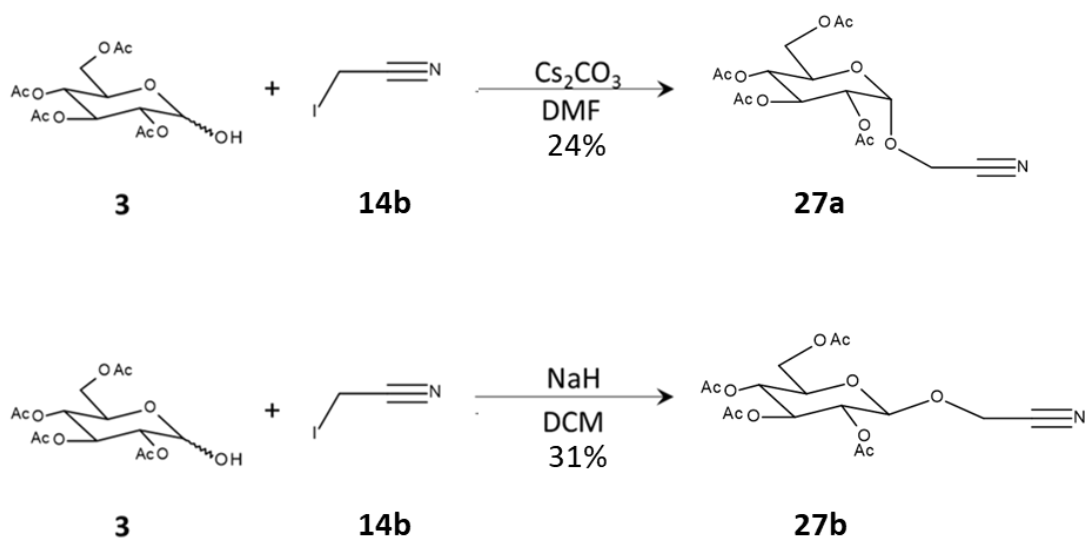

Scheme 19. Reaction between 3 and iodoacetonitrile (14b).

Experiments with **14b** showed a significant increase in reactivity to that of **14a**, and gave the yields given above

α -Bromocyclohexanone (**7b**), α -bromocyclopentanone (**6b**) and α -bromocyclododecanone (**10b**) in DCM

Anomeric O-alkylation in DCM with these electrophiles gave two diastereoisomers, this was taken to indicate that the pathway in DMF was substantially different to the one observed in DCM. While **7b** was the only electrophile to react in DMF it inexplicably was the only to not react well in DCM, giving only traces of glycoside.

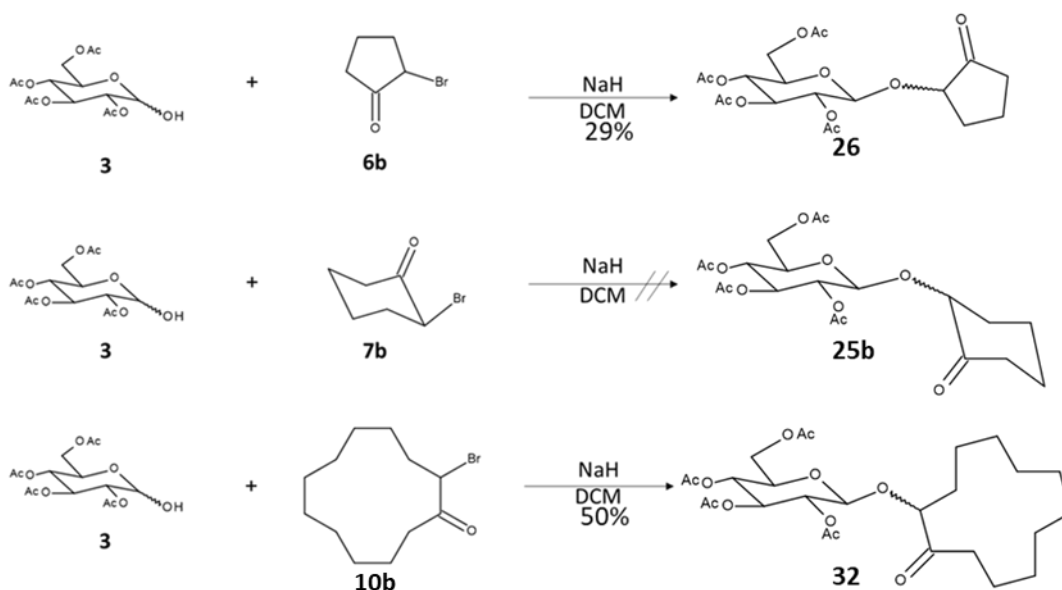

Scheme 20. Synthesis of glucosides with α -bromocyclohexanone, α -bromocyclopentanone and α -bromocyclododecanone.

Anomeric O-Alkylation as a Diastereoselective Glycosylation Method

Interestingly most of the secondary and tertiary electrophiles seemed to react only in DCM rather than DMF, this seemed to have something to do with the mechanism of nucleophilic substitution in the two different solvents.

Secondary halides were interesting as it gave a general idea of the pK_a of D-glucose; strongly basic anionic nucleophiles would push the reaction towards a favorskii rearrangement. The observed results indicated what was previously discussed (see Section 2.2.2) that pK_a of D-glucose is surprisingly low and this allows the reaction to progress in an SN1 or SN2 giving glycoside as its major product.

Synthesis of trityl Glucose

Benzyl halide groups are commonly accepted as strong electrophiles however in the anomeric O-alkylation it was been observed that surprisingly benzyl halides seemed unreactive in both DCM and DMF. Several attempts were made on benzyl chloride (**17a**), benzyl bromide (**17b**) and benzyl iodide (**17c**), the only observed glycoside was obtained with benzyl iodide where only traces when the reaction was performed in DMF.

The idea was then to try a more activated system; dichlorodiphenylmethane (**11**) was attempted as an electrophile using the regular conditions as well as with NaI as catalyst.

Interestingly traces were observed in both DCM as well as in DMF.

Finally, an attempt was made with trityl bromide (**15**) the most activated of the benzyl halides.

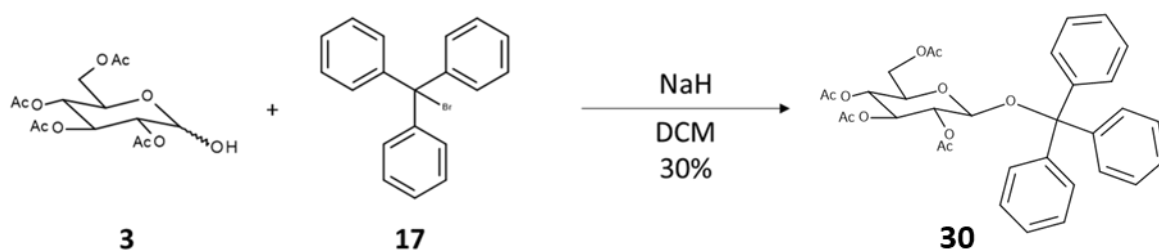

Scheme 21. Synthesis of β -trityl glucoside

Reaction proceeded fairly well in DCM (30%) and in DMF it gave the same product as DCM with lower relative quantities (observed in ^1H NMR)

3.3.4 Michael addition in glycosylation

An experiment where 3.5 mmol acrolein (**22**) and **2** or **3** was dissolved in 50 mL DCM and reacted using $\text{BF}_3 \cdot \text{Et}_2\text{O}$ (2mL) as catalyst. This reaction was very promising showing ^{13}C and ^1H NMR peaks which corresponded to α -glycoside formation.

Attempts were made with two other Michael acceptors methylvinylketone (MVK) (**23**) and crotononitrile (**21**) where MVK showed product and crotononitrile did not.

Problems were however encountered in an attempt to scale up the reaction which lead to rampant formation of side products. Due to the large amount of side products isolating glycosides proved to be difficult.

Several attempts were investigated to mitigate the problems of scaling with some limited success, however due to time constraints further attempts were abandoned in favor of the main goal of the thesis.

4 Concluding remarks

The objective for this thesis was to investigate the effects of anomeric O-alkylation on other electrophiles than the ones used by other students (α -haloacetophenones). Electrophiles like secondary and tertiary electrophiles became the focus of the thesis with some other electrophiles also being attempted. Other than this optimization of the original reaction as well as finding a cheap method of making tetraacetate was major goals which this thesis aimed to solve.

Secondary and tertiary electrophiles behaved differently than the original electrophiles and the ones used in this thesis showed remarkable stereoselectivity for α and β selectivity. However as expected diastereoisomers not located on the sugar did pose other problems as well as the reactions went poorly in DMF, where bromocyclohexanone is the notable exception and seemingly created nearly specifically one diastereoisomer in DMF but remained unreactive in DCM. It could be of interest to discover more of the reason for this behavior.

Reactions performed using **14b** indicated that the reaction proceeded in high yields. However, in this thesis the yields given are not exceedingly high, and were significantly lower than expected. This could be because the isolation of **27a** and **27b** was performed using MeOAc in heptanes instead of the TBME in 1-chlorobutane. Observations were made during the thesis that in general higher yields were observed with the new solvent system. Any future students who would wish to attempt this reaction should isolate the product using the solvent system that was used for the other glycosides.

Michael addition on **2** and **3** was discovered to work under specific conditions however scaling up seems to still be an issue that needs to be solved. Any future student should attempt this reaction at lower temperatures as well as with a lower concentration of $\text{BF}_3 \cdot \text{Et}_2\text{O}$ or similar Lewis acids.

Low yields were attained from the reaction between **2** and 2,3-dibromopropene future reactions should be attempted with this electrophile as this reaction showed a large amount of unreacted starting material. Internal Finklestein was not attempted due to time constraint, however this was attempted on all other electrophiles that proved difficult to react.

Several experiments were done to limit the formation of peracetylated product, discoveries included limiting base excess, adding base over time and starting the reaction in a cooled

Anomeric O-Alkylation as a Diastereoselective Glycosylation Method

solvent. In many cases these conditions made the formation of peracetylated product essentially negligible, the effects of these conditions were greater in DCM than DMF as the reaction in DMF occurs more slowly and the effects of cooling in the beginning has a lessened effect. Future experiments should be attempted in DMF to see if these conditions could have better effect when using DBU as a base as opposed to Cs₂CO₃ (or a similar base).

Conditions found give a significantly lower quantity of peracetylated product, however more experiments are required on the use of excess electrophile to see if conditions can be found where all **3** is used, and more of the glycoside is formed.

Deacetylation by the ammonia method on **3** proved to be quite successful, however with the ammonia generated *in situ* it was hard to scale up in MeCN. Future students should attempt this reaction with a more stable ammonia gas source (gas cylinder) or attempt the reaction under increased pressure.

5 Experimental

5.1 General

Nuclear magnetic resonance 400 MHz ^1H NMR spectra and 100MHz ^{13}C spectra were recorded on Bruker AvIII HD 400 MHz spectrometer. Nuclear magnetic resonance 500MHz ^1H NMR spectra and 125 MHz ^{13}C spectra were recorded on a Bruker Advance series 500 MHz AvII 500 spectrometer. Chemical shift of ^1H NMR spectra were reported in relative to tetramethylsilane (TMS) (δ 0.0 ppm) or dimethyl sulfoxide- d_6 (DMSO- d_6) (δ 2.50 ppm). ^{13}C NMR spectra are referenced in ppm to deuteriochloroform (δ 77.0 ppm) or dimethyl sulfoxide- d_6 (DMSO- d_6) (δ 39.51 ppm).

IR spectra were recorded on a Agilent Cary 630 FTIR spectrophotometer.

Dry flash chromatography (DFC) was carried out with silica gel (Sigma-Aldrich: Silica gel 60, particle size 0.040-0.063 mm (230-400 mesh)). Vacuum was created by a water aspirator.

Flash chromatography (FC) was carried out with silica gel (Sigma-Aldrich: Silica gel 60, particle size 0.040-0.063 mm (230-400 mesh)). Pressure was created using pressurized nitrogen.

Thin layer chromatography (TLC) was carried out using silica gel plates from Sigma-Aldrich (silica gel/dc-alufolienkieselgel with fluorescent indicator, production number 60778). The spots were detected with UV (extinction at $\lambda = 254$ nm or fluorescent at $\lambda = 366$ nm) in a UVP-UV cabinet and/or by staining with MOP (molybdate phosphoric acid (14 g) in ethanol (125 mL)), CER-MOP (molybdate phosphoric acid (5 g), cerium(IV)sulfate (2 g) and 98% sulfuric acid (16 mL) in water (180 mL)) or Anisaldehyde (5% 4-methoxybenzaldehyde in methanol (90 mL), 100% acetic acid (5 mL)) and developed by heating with a heat gun until spots appeared.

Melting points were determined on a Stuart scientific SMP3 melting point apparatus and were uncorrected.

Nitrogen was used in reactions that required dry conditions.

Anomeric O-Alkylation as a Diastereoselective Glycosylation Method

Commercially available chemicals were purchased from Fluka, Sigma-Aldrich, VWR, Acros, Merck, Lancaster and Chiron, standard purification was applied if necessary. Dry dichloromethane, ethyl acetate and acetone were purchased from VWR and Sigma-Aldrich.

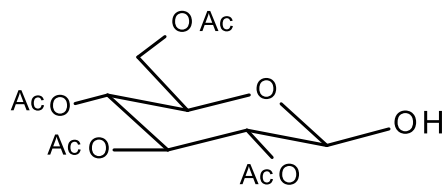
5.2 Synthesis of *D*-glucose-2,3,4,6-tetraacetate **β -D-Glucose-2,3,4,6-tetraacetate (3a)**

To a cooled (4 °C) solution of 2,3,4,5-tetra-O-acetyl- α -D-glucopyranosyl bromide (**1**) (41.12 g, 0.10 mol) and H₂O (1.80 g, 0.10 mol) in dry acetone (200 mL), Ag₂CO₃ (27.57 g, 0.10 mol) was added. The reaction was monitored by TLC as it warmed to room temperature. Solid silver salts precipitate was removed by filtration and the solvent was removed under reduced pressure to give a white solid. The crude was recrystallized from heptane and methyl acetate to yield translucent crystals. Yield: 31.70 g (91%). M.p.: 132-134 °C^[76]. R_f = 0.39 (50% MeOAc in heptane).

Spectroscopic values were in accordance with previous work^[77].

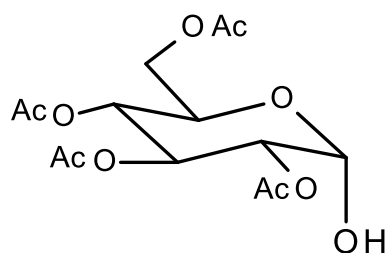
 α -D-Glucose-2,3,4,6-tetraacetate (3b)

A) To a solution of β -D-glucose-1,2,3,4,6-pentaacetate (**4b**) (39.03 g, 0.10 mol) in dimethylsulfoxide (DMSO) (200 mL) was added ammonium acetate (NH₄OAc) (15.42 g, 0.20 mol) and heated (60 °C) while stirring overnight. Water (500 mL) was added and extraction was performed with *tert*-butyl methyl ether (TBME) (5 × 50 mL), the combined organic phases were washed with water (4 × 20 mL) and dried (Na₂SO₄). Solvent was removed under reduced pressure to give a faintly orange viscous oil. M.p: N/A (Lit 101-102 °C) Yield: 27.83g (80%). R_f = 0.44 (50% MeOAc in heptane).

Spectroscopic values were in accordance with previous work^[77-78].

B) To a cooled solution of β -D-glucose-1,2,3,4,6-pentaacetate (**4b**) (39.03 g, 0.10 mol) in MeCN (150 mL) ammonia was bubbled through solution for 45 minutes. Ammonia was generated in situ from an ammonia generator of ammonium chloride (NH₄Cl) with dropwise addition of concentrated sodium hydroxide (NaOH). The reaction mixture was allowed to go to room temperature and monitored by TLC. Excess solvent was evaporated down to 20 mL then water (100 mL) was added and extraction was performed with TBME (5 × 50 mL), the combined organic phases were washed with water (4 × 20 mL) and dried (Na₂SO₄). Solvent was removed under reduced pressure to give a faintly orange viscous oil. Yield: 29.55 g (85%).

Anomeric O-Alkylation as a Diastereoselective Glycosylation Method

Spectroscopic results were as above given.

C) To a cooled solution of β -D-glucose-1,2,3,4,6-pentaacetate (**4b**) (117.10 g, 0.30 mol) in DMF (200 mL) ammonia was bubbled through solution for 45 minutes. Ammonia was generated in situ from an ammonia generator of ammonium chloride (NH_4Cl) with dropwise addition of concentrated sodium hydroxide (NaOH). The reaction mixture was allowed to go to room temperature and monitored by TLC. Water (500 mL) was added and the product was extracted with DCM (5×50 mL), the combined organic phases were washed with water (8×10 mL) and dried (Na_2SO_4). Solvent was removed under reduced pressure to give a faintly viscous oil. Yield: 94.92 g (91%).

Spectroscopic results were as above given.

5.3 Synthesis of α -haloketones

2-Bromocyclopentanone (**6b**)

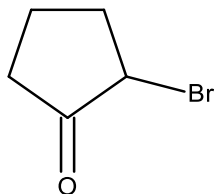

Para-toluenesulfonic acid (*p*-TsOH) (19.02 g, 0.10 mol) was dissolved in acetonitrile (MeCN) (100 mL) and added dropwise to a solution of cyclopentanone (**6a**) (8.41 g, 0.10 mol) and *N*-bromosuccinimide (NBS) (17.80 g, 0.10 mol) dissolved in dimethoxyethane (DME) (100 mL). The reaction was monitored on TLC. Water (500 mL) was added and product was extracted using TBME (5 × 50 mL), the combined organic phases were washed with water (4 × 20 mL) and dried (Na₂SO₄). Solvent was removed under reduced pressure to give a dark brown oil with brown precipitate. Yield: 14.08 g (86%). *R*_f = 0.45 (30% MeOAc in heptanes). ¹H NMR (400 MHz, CDCl₃): δ 4.23-4.21 (m, 1H), 2.43-2.34 (m, 2H), 2.26-2.14 (m, 3H), 2.04-1.95 (m, 1H); ¹³C NMR (100 MHz, CDCl₃): 211.3, 48.1, 34.9, 33.8, 20.1.

Spectroscopic values were in accordance with literature^[72].

2-Bromocyclohexanone (**7b**)

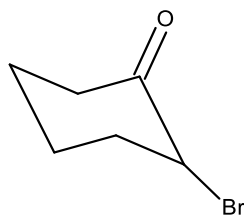

p-TsOH (19.02 g, 0.10 mol) was dissolved in MeCN (100 mL) and added dropwise to a solution of cyclohexanone (**7a**) (9.81 g, 0.10 mol) and NBS (17.80 g, 0.10 mol) dissolved in DME (100 mL). The reaction was monitored on TLC. Water (500 mL) was added and product was extracted using TBME (5 × 50 mL), the combined organic phases were washed with water (4 × 20 mL) and dried (Na₂SO₄). Solvent was removed under reduced pressure to give a deep purple or black oil. Yield: 16.19 g (91%). *R*_f = 0.50 (30% MeOAc in heptanes)

¹H NMR (400 MHz, CDCl₃): δ 4.44 (m, 1H), 3.01-2.94 (m, 1H), 2.37-2.28 (m, 2H), 2.25-2.18 (m, 1H), 2.06-1.92 (m, 2H), 1.86-1.78 (m, 1H), 1.77-1.69 (m, 1H); ¹³C NMR (100 MHz, CDCl₃): 203.4, 53.4, 37.9, 36.7, 26.7, 22.1.

Spectroscopic values were in accordance with literature^[79].

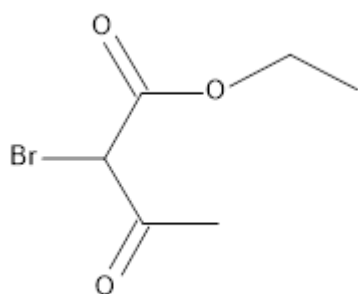
Ethyl 2-bromoacetoacetate (8b)

p-TsOH (0.39 g, 3.00 mmol) was dissolved in MeCN (50 mL) and added dropwise to a solution of ethyl acetoacetate (**8a**) (0.57 g, 3.00 mmol) and NBS (0.53 g, 3.00 mmol) dissolved in DME (50 mL). The reaction was monitored on TLC. Water (400 mL) was added and product was extracted with TBME

(5 × 50 mL), the combined organic phases were washed with water (4 × 20 mL) and dried (Na₂SO₄). Solvent was removed under reduced pressure to give a slightly yellow oil. Yield: 0.54 g (86%). *R*_f = 0.76 (25% MeOAc in heptanes)

¹H NMR (400 MHz, CDCl₃): δ 4.77 (s, 1H), 4.29 (q, *J* = 7.2, 2H), 2.44 (s, 3H), 1.31 (t, *J* = 7.2, 3H); ¹³C NMR (100 MHz, CDCl₃): 196.2, 165.1, 63.1, 49.1, 26.3, 13.8.

Spectroscopic values were in accordance with literature^[80].

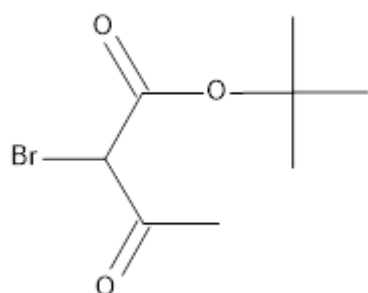
***tert*-Butyl 2-bromoacetoacetate (9b)**

p-TsOH (19.02 g, 0.10 mol) was dissolved in MeCN (100 mL) and added dropwise to a solution of *tert*-butyl acetoacetate (**9a**) (15.81 g, 0.10 mol) and NBS (17.80 g, 0.10 mol) dissolved in DME (100 mL). The reaction was monitored on TLC. Water (500 mL) was added and product was extracted with TBME (5 × 50 mL), the combined organic phases were washed with water (4 × 20 mL) and dried

(Na₂SO₄). Solvent was removed under reduced pressure to give a slightly yellow oil. Yield: 21.97 g (92%). *R*_f = 0.82 (25% MeOAc in heptanes)

IR (neat): ν 2980, 2917, 2849, 1719, 1458, 1395, 1369, 1304, 1286, 1132, 1022, 944, 844, 780 cm⁻¹; ¹H NMR (400 MHz, CDCl₃): δ 4.67 (s, 1H), 2.40 (s, 3H), 1.50 (s, 9H); ¹³C NMR (100 MHz, CDCl₃): 196.5, 163.9, 84.4, 50.6, 27.6, 26.2.

Spectroscopic values were in accordance with literature^[80b].

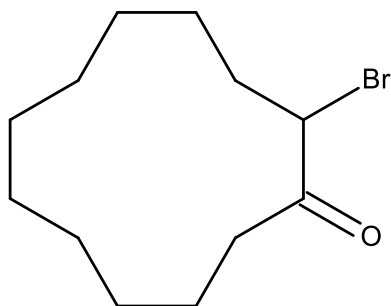
2-Bromocyclododecanone (10b)

p-TsOH (19.02 g, 0.10 mol) was dissolved in MeCN (100 mL) and added dropwise to a solution of cyclododecanone (**10a**) (18.23 g, 0.10 mol) and NBS (17.80 g, 0.10 mol) dissolved in DME (100 mL). The reaction was monitored on TLC. Water (500 mL) was added and product was extracted using TBME (5 × 50 mL), the combined organic phases were washed with water (4 × 20 mL) and dried

(Na₂SO₄). Solvent was removed under reduced pressure to give a white powder. Yield: 23.61 (90%). M.p. 52-54 °C (lit 53-54 °C^[81]). R_f = 0.89 (25% MeOAc in heptanes)

¹H NMR (400 MHz, CDCl₃): δ 4.39 (dd, *J* = 11.7, 3.7 Hz, 1H), 2.84-2.67 (m, 2H), 2.35-2.26 (m, 2H), 2.02-1.87 (m, 2H), 1.63-1.55 (m, 2H), 1.41-1.19 (m, 12H); ¹³C NMR (100 MHz, CDCl₃): 205.5, 51.6, 35.2, 33.5, 25.3, 24.1, 23.7, 22.4, 22.1.

Spectroscopic values are in accordance with previous work^[82].

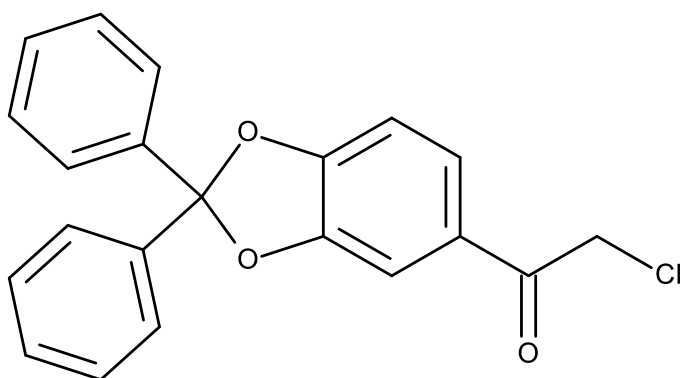
2-Chloro-1-(2,2-diphenyl-1,3-benzodioxol-5-yl)ethanone (19)

Solution of 2-chloro-1-(3,4-dihydroxyphenyl)ethanone (**18**) (36.89 g, 0.20 mol) and 1,1-diphenyl-1,1-dichloromethane (**11**) (47.38 g, 0.20 mol) in toluene (150 mL) was refluxed overnight. Solvent was evaporated to give a light brown solid.

Yield: 54.67 g (78%). M.p.: 96-100 °C (Lit 100-101 °C^[83]).

¹H NMR (400 MHz, CDCl₃): δ 7.62-7.55 (m, 6H), 7.44-7.39 (m, 5H), 6.96 (d, *J* = 8.1, 2H), 4.62 (s, 2H); ¹³C NMR (100 MHz, CDCl₃): δ 189.2, 151.9, 147.9, 139.3, 129.4, 128.9, 128.3, 126.1, 125.0, 118.5, 108.4, 108.2, 45.6.

Spectroscopic values were in accordance with previous work^[83].

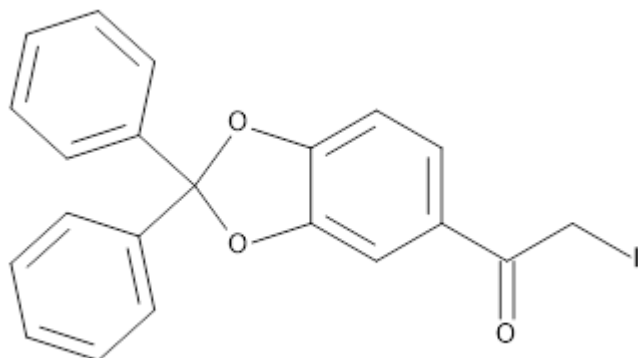
2-Iodo-1-(2,2-diphenyl-1,3-benzodioxol-5-yl)ethanone (20)

To a solution of 2-chloro-1-(2,2-diphenyl-1,3-benzodioxol-5-yl)ethanone (**19**) (38.40 g, 0.10 mol) in MeCN (100 mL) was added NaI (22.56 g, 0.15 mol) and stirred overnight. Water (400 mL) was added and product was extracted with TBME (5 × 50 mL), the combined organic phases were

washed with water (4 × 20 mL) and dried (Na₂SO₄). Product was recrystallized in methylcyclohexane giving yellow crystals. Yield: 40.73 g (92%). M.p.: 104-107 °C (Lit 105-107 °C^[83])

¹H NMR (400 MHz, CDCl₃): 7.63-7.56 (m, 6H), 7.43-7.39 (m, 5H), 6.95 (d, *J* = 7.8, 2H), 4.29 (s, 2H); ¹³C NMR (100 MHz, CDCl₃): 191.0, 151.8, 147.9, 139.4, 129.4, 128.3, 128.1, 126.1, 125.6, 118.5, 108.4, 108.2, 1.4.

Spectroscopic values were in accordance with previous work^[83].

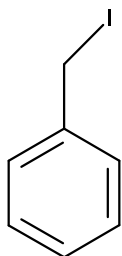
Benzyl iodide (17c)

To a solution of benzyl chloride (**17a**) (3.16 g, 25.00 mmol) in MeCN was added NaI (5.62 g, 37.50 mmol) and stirred for five hours. Solvent was evaporated until salt could be removed by vacuum filtration. Yield: 4.69 g (86%)

¹H NMR (400 MHz, CDCl₃): δ 7.38-7.23 (m, 5H), 4.45 (s, 2H); ¹³C NMR (100 MHz, CDCl₃): 139.3, 128.8, 128.7, 127.8, 5.7.

Spectroscopic values were in accordance with literature^[84].

5.4 General procedures for testing glycosylation conditions

General procedure for effect of adding base over time

Under dry conditions 2-iodo-1-(2,2-diphenyl-1,3-benzodioxol-5-yl)ethanone (**20**) (1.32 g, 3.00 mmol) and D-glucose-2,3,4,6-tetraacetate (**3**) (1.04 g, 3.00 mmol) were dissolved in DCM or DMF (30mL). Base (Cs_2CO_3 or NaH) was added over fifteen minutes or in one go, reaction mixture was left to react overnight. Excess base was neutralized with HCl (6M). Water (150 mL) was added and product was extracted with TBME (5×50 mL), the combined organic phases were washed with water (4×20 mL) and dried (Na_2SO_4). Solvent was removed under reduced pressured.

Relative values of peracetylated sugar was estimated with ^1H NMR.

General procedure for effect of base concentration

Under dry conditions 2-iodo-1-(2,2-diphenyl-1,3-benzodioxol-5-yl)ethanone (**20**) (1.32 g, 3.00 mmol) and D-glucose-2,3,4,6-tetraacetate (**3**) (1.04 g, 3.00 mmol) were dissolved in dry solvent (DCM or DMF) (30mL). Base (Cs_2CO_3 or NaH) was added in appropriate quantities (0.75, 1, 1.25, 1.5 and 2 equivalents) and reaction mixture was left to react overnight. Excess base was neutralized with HCl (6M). Water (150 mL) was added and product was extracted with TBME (5×50 mL), the combined organic phases were washed with water (4×20 mL) and dried (Na_2SO_4). Solvent was removed under reduced pressured.

Relative values of peracetylated sugar was estimated with ^1H NMR.

General procedure for effect of temperature

Under dry conditions 2-iodo-1-(2,2-diphenyl-1,3-benzodioxol-5-yl)ethanone (**20**) (1.32 g, 3.00 mmol) and D-glucose-2,3,4,6-tetraacetate (**3**) (1.04 g, 3.00 mmol) were dissolved in dry solvent (DCM or DMF) (30mL). Reaction mixture was brought to appropriate temperature (R.T., 4°C and 0°C). Base (Cs_2CO_3 or NaH) was added, reaction mixture was allowed to reach R.T. and was left to react overnight. Excess base was neutralized with HCl (6M). Water (150 mL) was added and product was extracted with TBME (5×50 mL), the combined organic phases were washed with water (4×20 mL) and dried (Na_2SO_4). Solvent was removed under reduced pressured.

Relative values of peracetylated sugar was estimated with ^1H NMR.

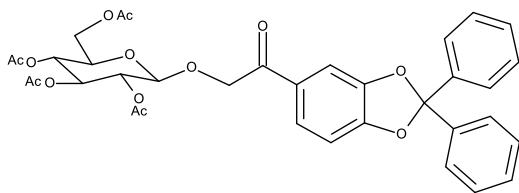
2-(2,3,4,6-tetra-O-acetyl- β -D-glucopyranosyloxy)-1-(2,2-diphenyl-1,3-benzodioxol-5-yl)ethenone (34b)

Under dry conditions NaH in oil suspension (0.5 g, 12.50 mmol) was added to a cooled (4 °C) solution of 2-Iodo-1-(2,2-diphenyl-1,3-benzodioxol-5-yl)ethenone (**20**) (1.77 g, 10.00 mmol) and D-glucose-2,3,4,6-tetraacetate (**3**) (3.47 g, 10.00 mmol) in DCM (50mL). The mixture was allowed to reach R.T and left stirring overnight. Excess NaH was neutralized with HCl (6M). Product was purified by DFC (Silica gel 60, 20% TBME in chlorobutane). Spectroscopic values were in accordance with previous work^[83]. Spectroscopic values were used as blind for experiments given above.

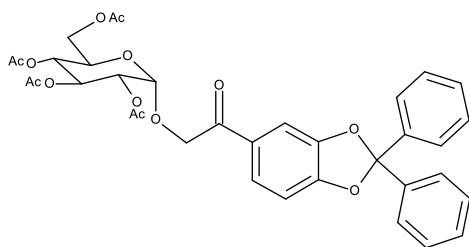
2-(2,3,4,6-tetra-O-acetyl- α -D-glucopyranosyloxy)-1-(2,2-diphenyl-1,3-benzodioxol-5-yl)ethenone (34a)

Cs₂CO₃ (3.26 g, 10.00 mmol) was added to a solution of 2-Iodo-1-(2,2-diphenyl-1,3-benzodioxol-5-yl)ethenone (**20**) (1.77 g, 10.00 mmol) and D-glucose-2,3,4,6-tetraacetate (**3**) (3.47 g, 10.00 mmol) in DMF (50 mL). The mixture was left stirring overnight, and in the morning monitored with TLC. Excess Cs₂CO₃ was neutralized with HCl (6M). Water was added so that the ratio of DMF to water was 1:5 and the product was extracted with TBME (5 × 50 mL), the combined organic phases were washed with water (4 × 20 mL) and dried (Na₂SO₄). Solvent was removed under reduced pressured to give a yellow viscous oil. Spectroscopic values were in accordance with previous work^[85]. Spectroscopic values were used as blind for experiments given above.

General procedure for testing Michael addition in glycosylation

Michael acceptor (3.5 mmol) and D-Glucose-2,3,4,6-tetraacetate (**3**) (1.04g, 3.5 mmol) were dissolved in DCM (50mL) and BF₃·Et₂O (2mL) was added. Reaction mixture was left to react overnight, and product was purified by DFC.

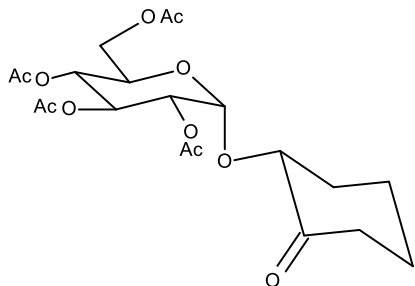
5.5 α -glycosylation2-(2,3,4,6-Tetra-O-acetyl- α -D-glucopyranosyloxy)cyclohexanone (**25a**)

Under dry conditions Cs_2CO_3 (4.07 g, 12.50 mmol) was added to a cooled (4°C) solution of 2-bromocyclohexanone (**7b**) (1.77 g, 10.00 mmol) and D-glucose-2,3,4,6-tetraacetate (**3**) (3.47 g, 10.00 mmol) in DMF (50 mL). The mixture was allowed to reach R.T and left stirring overnight. Excess Cs_2CO_3 was neutralized with HCl (6M). Water (250 mL) was added and the product was extracted with TBME (5×50 mL), the combined organic phases were washed with water (4×20 mL) and dried (Na_2SO_4). Crude product was purified with flash chromatography (FC) (Silica gel 60, 20% TBME in chlorobutane). Solvent was removed under reduced pressure to give a yellow semi solid.

Yield: 1.59 g (35%). $R_f = 0.31$ (20% TBME in chlorobutane).

IR (neat): ν 2974, 2859, 1748, 1475, 1450, 1373, 1214, 1178, 1143, 1089, 1049, 946, 886, 811, 789 cm^{-1} ; ^1H NMR (500 MHz, CDCl_3): δ 5.49 – 5.45 (m, 1 H), 5.09 (d, $J = 3.8$ Hz, 1 H), 5.00 - 4.97 (m, 1H), 4.90 – 4.87 (m, 1 H), 4.78 (dd, $J = 10.4, 3.8$ Hz, 1 H), 4.15 (dd, $J = 12.4, 4.4$ Hz, 1 H), 4.12 – 4.09 (m, 1 H), 4.06 (dd, $J = 12.4, 2.4$ Hz, 1 H), 4.00 – 3.98 (m, 1 H), 3.62 (ddd, $J = 12.4, 4.5, 2.4$ Hz, 1 H), 3.47 (t, $J = 6.7$ Hz, 1 H), 2.12 (s, 3 H), 2.02 (s, 3 H), 1.96 (s, 3 H), 1.95 (s, 3 H), 1.79 – 1.55 (m, 8 H); ^{13}C NMR (125 MHz, CDCl_3): δ 207.0, 170.6, 170.5, 170.0, 169.5, 94.9, 79.0, 70.2, 69.6, 68.6, 67.5, 61.8, 40.7, 34.3, 26.9, 23.7, 20.7, 20.6, (2 x CH_3), 20.5.

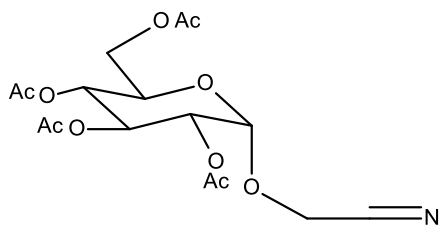
2-(2,3,4,6-Tetra-O-acetyl- α -D-glucopyranosyloxy)acetonitrile (27a)

Under dry conditions Cs_2CO_3 (4.07 g, 12.50 mmol) was added to a cooled (4 °C) solution of iodoacetonitrile (**14b**) (1.67 g, 10.00 mmol) and D-glucose-2,3,4,6-tetraacetate (**3**) (3.47 g, 10.00 mmol) in DMF (50mL). The mixture was allowed to reach R.T and left stirring overnight.

Excess Cs_2CO_3 was neutralized with HCl (6M). Water (250 mL) was added and the product was extracted with TBME (5 × 50mL), the combined organic phases were washed with water (4 × 20mL) and dried (Na_2SO_4). Crude product was purified with flash chromatography (FC) (Silica gel 60, 20% MeOAc in heptane). Solvent was removed under reduced pressured to give an orange viscous oil.

Yield: 0.96 g (24%). $R_f = 0.23$ (20% TBME in chlorobutane).

IR (neat): ν 2960, 2900, 2793, 2200, 1749, 1437, 1369, 1232, 1139, 1048, 930, 897 cm^{-1} ; ^1H NMR (500 MHz, CDCl_3): δ 5.49 – 5.45 (m, 1 H), 5.22 (d, $J = 3.7$ Hz, 1 H), 5.14 - 5.10 (m, 1H), 4.95 (dd, $J = 10.3, 3.7$ Hz, 1 H), 4.46 (d, $J = 16.2$ Hz, 1 H), 4.33 (d, $J = 16.2$ Hz, 1 H) 4.29 (dd, $J = 12.4, 4.3$ Hz, 1 H), 4.17 (dd, $J = 12.4, 2.1$ Hz, 1 H), 4.08 (ddd, $J = 12.4, 4.3, 2.1$ Hz, 1 H), 2.11 (s, 3 H), 2.10 (s, 3 H), 2.05 (s, 3 H), 2.03 (s, 3 H); ^{13}C NMR (125 MHz, CDCl_3): δ 170.5, 170.0, 169.9, 169.4, 115.0, 96.8, 70.0, 69.4, 68.6, 67.9, 61.3, 53.5, 20.7, 20.6, 20.5, 20.4.

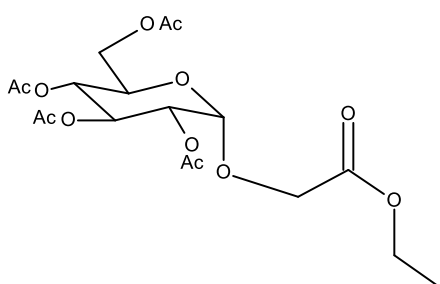
2-(2,3,4,6-Tetra-O-acetyl- α -D-glucopyranosyloxy)ethylacetate (28a)

Under dry conditions Cs_2CO_3 (4.07 g, 12.50 mmol) was added to a cooled (4 °C) solution of ethyl bromoacetate (**12**) (1.67 g, 10.00 mmol) and D-glucose-2,3,4,6-tetraacetate (**3**) (3.47 g, 10.00 mmol) in DMF (50 mL). The mixture was allowed to reach R.T and left stirring overnight. Excess Cs_2CO_3 was neutralized with HCl

(6M). Water (250 mL) was added and the product was extracted with TBME (5 × 50mL), the combined organic phases were washed with water (4 × 20mL) and dried (Na_2SO_4). Solvent was removed under reduced pressured to give an orange viscous oil. Yield: 0.95 g (22%)

Spectroscopic values were in accordance with previous work^[73].

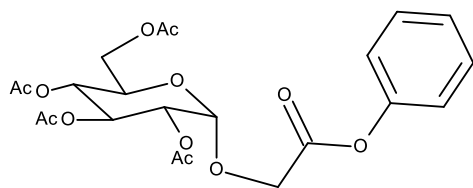
2-(2,3,4,6-Tetra-O-acetyl- α -D-glucopyranosyloxy)benzylacetate (29b)

Under dry conditions Cs_2CO_3 (4.07 g, 12.50 mmol) was added to a cooled (4 °C) solution of benzyl bromoacetate (**16**) (2.15 g, 10.00 mmol) and D-glucose-2,3,4,6-tetraacetate (**3**) (3.47 g, 10.00 mmol)

in DMF (50mL). The mixture was allowed to reach R.T and left stirring overnight. Excess Cs_2CO_3 was neutralized with HCl (6M). Water (250 mL) was added and the product was extracted with TBME (5 × 50mL), the combined organic phases were washed with water (4 × 20mL) and dried (Na_2SO_4). Solvent was removed under reduced pressured to give a yellow viscous oil. Yield: 1.92 g (39%).

Spectroscopic values were in accordance with previous work^[73].

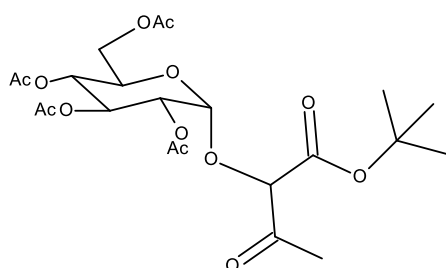
***tert*-Butyl 2-(2,3,4,6-Tetra-O-acetyl- α -D-glucopyranosyloxy)acetoacetate (31a)**

Under dry conditions NaH in oil suspension (0.50 g, 12.50 mmol) was added to a cooled (4 °C) solution of *tert*-butyl 2-bromoacetoacetate (**9b**) (2.38 g, 10.00 mmol) and D-glucose-2,3,4,6-tetraacetate (**3**) (3.47 g, 10.00 mmol) in DCM (50mL). The mixture was allowed to reach R.T. and left stirring overnight. Excess NaH

was neutralized with HCl (6M). Solvent was removed under reduced pressure to give a yellow viscous oil.

Crude product was purified with flash chromatography (FC) (Silica gel 60, 20% TBME in chlorobutane). Yield: 2.61 g (51%). $R_f = 0.15$ (20% TBME in chlorobutane). ^1H NMR was not acquired as there was a mixture of two diastereoisomers.

IR (neat): ν 2984, 2943, 1749, 1456, 1398, 1221, 1151, 1043, 938, 906, 742 cm^{-1} ; ^{13}C NMR (125 MHz, CDCl_3): 198.6, 170.5, 170.4, 170.0, 169.3, 169.0, 168.9, 163.2, 96.4, 94.6, 84.4, 72.6, 72.5, 72.4, 72.3, 70.8, 70.7, 68.0, 67.9, 61.4, 61.2, 27.7, 27.5, 25.6, 20.7, 20.6, 20.5, 20.4.

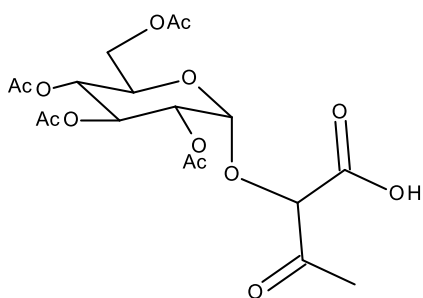
2-(2,3,4,6-Tetra-O-acetyl- α -D-glucopyranosyloxy)acetoacetic acid (31b)

31a (2.61 g, 5.50 mmol) was dissolved in a one to one solution of tetrahydrofuran (THF) and water (50mL). *p*-TsOH was added as catalyst and reaction mixture was left stirring overnight. In the morning reaction was monitored by TLC, water was added, and the product was extracted with TBME (5 × 50mL). The combined

organic phases were washed with water (4 × 20mL) and dried (Na₂SO₄). Solvent was removed under reduced pressure to give a brown viscous oil. Yield: 2.03 g (81%). R_f = 0.12 (20% TBME in chlorobutane). ¹H NMR was not acquired as there was a mixture of two diastereoisomers.

IR (Neat): ν 2980, 2933, 2115, 1748, 1649, 1432, 1432, 1369, 1121, 1151, 1037, 906, 840 cm⁻¹; ¹³C NMR (100 MHz, CDCl₃): 198.7, 170.6, 170.5, 170.0, 169.3, 169.0, 168.9, 163.3, 96.5, 94.8, 72.8, 72.7, 72.6, 72.5, 72.4, 70.9, 70.8, 68.0, 67.9, 49.4, 27.6, 26.9, 25.7, 25.6, 20.7, 20.6, 20.5.

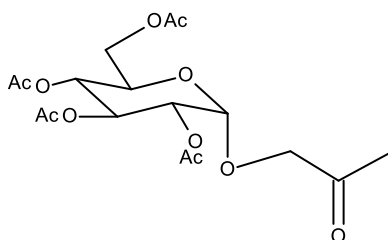
1-(2,3,4,6-Tetra-O-acetyl- α -D-glucopyranosyloxy)propanone (31c)

31b (2.03 g, 4.87 mmol) was dissolved in 1-methoxy-2-(2-methoxyethoxy)ethane (Diglyme) (40mL), the reaction mixture was heated (130 °C) and left stirring overnight. In the morning reaction was monitored by TLC, water was added, and the product was extracted with toluene (5 ×

50mL). The combined organic phases were washed with water (10 × 20mL) and dried (Na₂SO₄). Solvent was removed under reduced pressure to give a brown viscous oil.

Yield: 1.00 g (50%). ¹H NMR and IR was not acquired due to time constraints.

¹³C NMR (100 MHz, CDCl₃): 200.9, 170.5, 170.1, 170.0, 169.5, 169.4, 169.3, 169.2, 98.1, 95.9, 72.4 (2 × C), 71.7, 70.7, 70.6, 68.2, 67.8, 61.7, 60.8, 35.4, 26.4, 26.3, 24.0, 20.7, 20.6, 20.5, 20.4.

1-(2,3,4,6-Tetra-O-acetyl- α -D-glucopyranosyloxy)-2-bromoprop-2-ene (33)

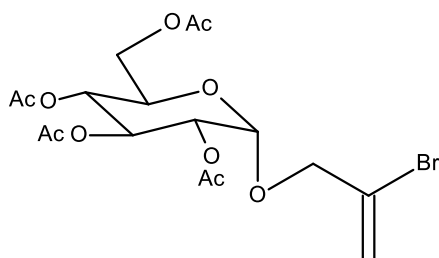

Under dry conditions Cs_2CO_3 (4.07 g, 12.50 mmol) was added to a cooled (4°C) solution of 2,3-dibromopropene (**24**) (80%) (2.50 g, 10.00 mmol) and D-glucose-2,3,4,6-tetraacetate (**3**) (3.47 g, 10.00 mmol) in DMF (50mL). The mixture was allowed to reach R.T and left stirring overnight.

Excess Cs_2CO_3 was neutralized with HCl (6M). Water (250 mL) was added and the product was extracted with TBME ($5 \times 50\text{mL}$), the combined organic phases were washed with water ($4 \times 20\text{mL}$) and dried (Na_2SO_4). Solvent was removed under reduced pressure to give a brown viscous oil.

Crude product was purified with flash chromatography (FC) (Silica gel 60, 20% TBME in chlorobutane). Yield: 419 mg (9%). $R_f = 0.43$ (20% TBME in chlorobutane). ^1H NMR was not acquired due to time constraints.

IR (neat): ν 2960, 2911, 2855, 2111, 1743, 1637, 1509, 1433, 1367, 1217, 1167, 1032, 902, 796 cm^{-1} ; ^{13}C NMR (100 MHz, CDCl_3): 170.6, 170.2, 170.1, 169.6, 127.5, 119.6, 94.6, 72.4, 71.6, 70.5, 70.0, 68.4, 67.8, 61.7, 20.7, 20.6.

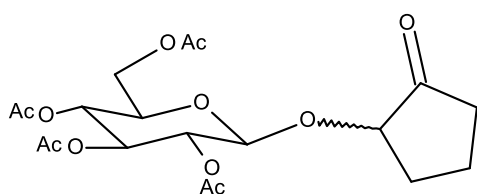
5.6 β -glycosylation2-(2,3,4,6-tetra-O-acetyl- β -D-glucopyranosyloxy)cyclopentanone (**26**)

Under dry conditions NaH in oil suspension (0.5 g, 12.50 mmol) was added to a cooled (4 °C) solution of bromocyclopentanone (**6b**) (1.63 g, 10.00 mmol) and D-glucose-2,3,4,6-tetraacetate (**3**) (3.47 g, 10.00

mmol) in DCM (50mL). The mixture was allowed to reach R.T and left stirring overnight. Excess NaH was neutralized with HCl (6M). Crude product was purified with flash chromatography (FC) (Silica gel 60, 20% TBME in chlorobutane). Solvent was removed under reduced pressure to give a light brown solid.

Yield: 1.28 g (29%). M.p.: 127-130 °C. R_f = 0.25 (20% TBME in chlorobutane).

Spectroscopic values of isolated diastereoisomer:

IR (neat): ν 2943, 2786, 1743, 1456, 1397, 1217, 1049, 987, 948, 833, 788, 745 cm^{-1} ; ^1H NMR (500 MHz, CDCl_3): δ 5.16 – 5.12 (m, 1 H), 5.00 - 4.96 (m, 1H), 4.90 – 4.87 (m, 1 H), 4.85 (d, J = 7.9 Hz, 1 H), 4.16 (dd, J = 12.4, 4.5 Hz, 1 H), 4.05 (dd, J = 12.4, 2.4 Hz, 1 H), 4.00 – 3.97 (m, 1 H), 3.44 (t, J = 6.7 Hz, 1 H), 3.62 (ddd, J = 12.4, 4.5, 2.4 Hz, 1 H), 1.99 (s, 3 H), 1.96 (s, 3 H), 1.93 (s, 3 H), 1.90 (s, 3 H), 1.86 – 1.67 (m, 6 H); ^{13}C NMR (125 MHz, CDCl_3): δ 214.7, 170.4, 169.9, 169.4, 169.3, 99.7, 78.7, 72.5, 71.6, 71.0, 68.3, 61.7, 35.1, 29.9, 20.6, 20.5, 20.4, 17.2.

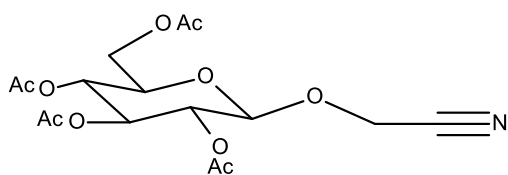
2-(2,3,4,6-tetra-O-acetyl- β -D-glucopyranosyloxy)acetonitrile (27b)

Under dry conditions NaH in oil suspension (0.5 g, 12.50 mmol) was added to a cooled (4 °C) solution of Iodoacetonitrile (**14b**) (1.67 g, 10.00 mmol) and D-glucose-2,3,4,6-tetraacetate (**3**) (3.47 g, 10.00

mmol) in DCM (50mL). The mixture was allowed to reach R.T and left stirring overnight. Excess NaH was neutralized with HCl (6M). Solvent was removed under reduced pressure to give a white viscous oil.

Crude product was purified with flash chromatography (FC) (Silica gel 60, 20% MeOAc in heptane). Yield: 1.23 g (31%). $R_f = 0.20$ (20% TBME in chlorobutane).

IR (neat): ν 2960, 2900, 2793, 2200, 1749, 1437, 1369, 1232, 1139, 1048, 930, 897 cm^{-1} ; ^1H NMR (500 MHz, CDCl_3): δ 5.22 – 5.19 (m, 1 H), 5.09 -5.05 (m, 1H), 5.02 – 4.98 (m, 1 H), 4.69 (d, $J = 7.9$ Hz, 1 H), 4.47 (d, $J = 16.2$ Hz, 1 H), 4.40 (d, $J = 16.2$ Hz, 1 H) 4.24 (dd, $J = 12.5, 4.8$ Hz, 1 H), 4.14 (dd, $J = 12.5, 2.3$ Hz, 1 H), 3.75 (ddd, $J = 12.5, 4.8, 2.3$ Hz, 1 H), 2.07 (s, 3 H), 2.05 (s, 3 H), 2.00 (s, 3 H), 1.98 (s, 3 H); ^{13}C NMR (125 MHz, CDCl_3): δ 170.5, 170.1, 169.3 (2 x C), 114.8, 99.0, 72.4, 72.3, 70.6, 67.9, 61.5, 53.2, 20.7 (2 x CH_3), 20.6, 20.5.

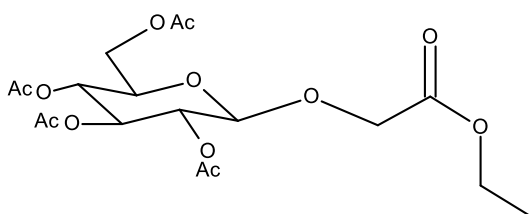
2-(2,3,4,6-tetra-O-acetyl- β -D-glucopyranosyloxy)ethylacetate (28b)

Under dry conditions NaH in oil suspension (0.5 g, 12.50 mmol) was added to a cooled (4 °C) solution of ethyl bromoacetate (**12**) (1.67 g, 10.00 mmol) and D-glucose-2,3,4,6-tetraacetate (**3**) (3.47 g, 10.00 mmol) in DCM (50mL). The

mixture was allowed to reach R.T and left stirring overnight. Excess NaH was neutralized with HCl (6M). Solvent was removed under reduced pressure to give an orange viscous oil.

Crude product was purified with flash chromatography (FC) (Silica gel 60, 20% TBME in chlorobutane). Yield: 1.32 g (30%).

Spectroscopic values were in accordance with previous work^[73].

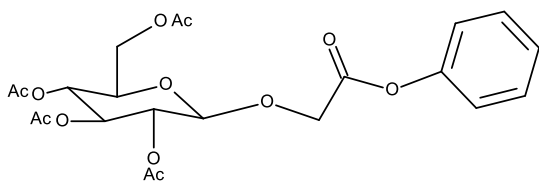
2-(2,3,4,6-tetra-O-acetyl- β -D-glucopyranosyloxy)benzylacetate (29b)

Under dry conditions NaH in oil suspension (0.5 g, 12.50 mmol) was added to a cooled (4 °C) solution of benzyl bromoacetate (**16**) (2.15 g, 10.00 mmol) and D-glucose-2,3,4,6-tetraacetate

(**3**) (3.47 g, 10.00 mmol) in DCM (50mL). The mixture was allowed to reach R.T and left stirring overnight. Excess NaH was neutralized with HCl (6M). Solvent was removed under reduced pressure to give a yellow viscous oil.

Crude product was purified with flash chromatography (FC) (Silica gel 60, 20% TBME in chlorobutane). Yield: 1.30 g (27%).

Spectroscopic values were in accordance with previous work^[73].

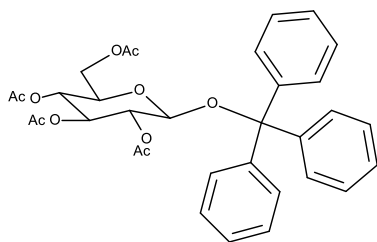
1-(2,3,4,6-tetra-O-acetyl- β -D-glucopyranosyloxy)triphenylmethane (30)

Under dry conditions NaH in oil suspension (0.50 g, 12.50 mmol) was added to a cooled (4 °C) solution of bromotriphenylmethane (**15**) (3.23 g, 10.00 mmol) and D-glucose-2,3,4,6-tetraacetate (**3**) (3.47 g, 10.00 mmol) in DCM (50mL). The mixture was allowed to reach R.T and left

stirring overnight. Excess NaH was neutralized with HCl (6M). Solvent was removed under reduced pressure to give a light brown solid.

Crude product was purified with flash chromatography (FC) (Silica gel 60, 20% TBME in chlorobutane). Yield: 1.77 g (30%). M.p.: 143-147 °C (lit 149 °C^[86]). R_f = 0.52 (20% TBME in chlorobutane).

IR (neat): ν 3056, 2986, 2947, 2860, 2200, 1747, 1647, 1525, 1445, 1349, 1210, 1050, 892, 800, 753, 704 cm⁻¹; ¹H NMR (500 MHz, CDCl₃): δ 7.49 – 7.18 (m, 15 H), 5.36 – 5.33 (m, 1 H), 5.00 - 4.96 (m, 1H), 4.90 – 4.87 (m, 1 H), 4.19 (d, *J* = 8.1 Hz, 1 H), 3.93 (dd, *J* = 12.0, 5.1 Hz), 3.62 (dd, *J* = 12.0, 2.7 Hz), 2.97 (ddd, *J* = 12.0, 5.1, 2.7 Hz, 1 H), 2.00 (s, 3 H), 1.97 (s, 3 H), 1.92 (s, 6 H); ¹³C NMR (125 MHz, CDCl₃): δ 170.2, 170.1, 169.3, 169.2, 143.6, 95.7, 88.8, 72.9, 71.1, 70.8, 68.6, 61.6, 20.6, 20.5, 20.4, 20.3.

Spectroscopic values were in accordance with literature^[86].

2-(2,3,4,6-tetra-O-acetyl- β -D-glucopyranosyloxy)cyclododecanone (32)

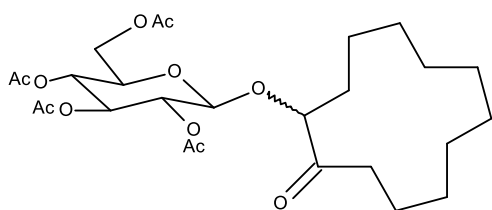

Under dry conditions NaH in oil suspension (0.5 g, 12.50 mmol) was added to a cooled (4 °C) solution of bromocyclododecanone (**10b**) (2.60 g, 10.00 mmol) and D-glucose-2,3,4,6-tetraacetate (**3**) (3.47 g, 10.00 mmol) in DCM (50mL). The mixture was

allowed to reach R.T and left stirring overnight. Excess NaH was neutralized with HCl (6M). Crude product was purified with flash chromatography (FC) (Silica gel 60, 20% TBME in chlorobutane). Solvent was removed under reduced pressure to give a yellow solid.

Yield: 2.69 g (50%) M.p.: 113-116 °C. R_f = 0.46 (20% TBME in chlorobutane). ^1H NMR was not acquired as there was a mixture of two diastereoisomers.

IR (Neat): ν 2934, 2865, 2121, 1751, 1730, 1439, 1367, 1217, 1168, 1038, 907, 730 cm^{-1} ; ^{13}C NMR (125 MHz, CDCl_3): 211.6, 210.4, 170.6, 170.2, 169.4, 169.3, 101.1, 99.4, 87.4, 83.6, 72.6, 71.8, 71.2, 71.1, 69.8, 68.5, 68.3, 61.8, 61.7, 33.9, 33.3, 29.7, 26.4, 26.3, 26.2, 23.8, 23.7, 22.6, 22.2, 22.1, 22.0, 21.1, 21.0, 20.7, 20.6, 20.5, 19.6, 19.3.

Literature

- [1] a) Lichtenthaler, F. W., *Angew. Chem., Int. Ed.* **1992**, *31*, 1541-1556, b) Fischer, E., Armstrong, E. F., *Chem. Ber.* **1901**, 2885-2900.
- [2] Tvaroška, I., Bleha, T., in *Advances in Carbohydrate Chemistry and Biochemistry*, Vol. 47 (Eds.: Tipson, R. S., Horton, D.), Academic Press, **1989**, pp. 45-123.
- [3] Román-Leshkov, Y., et al., *Angew. Chem., Int. Ed.* **2010**, *49*, 8954-8957.
- [4] Dieter, K., et al., *Angew. Chem., Int. Ed.* **2005**, *44*, 3358-3393.
- [5] Young, F. G., *Br. Med. J.* **1957**, *1*, 1431-1437.
- [6] Salzner, U., Schleyer, P. v. R., *J. Org. Chem.* **1994**, *59*, 2138-2155.
- [7] Schmidt, R. R., Zimmermann, P., *Angew. Chem., Int. Ed.* **1986**, *25*, 725-726.
- [8] Ha, S., et al., *J. Am. Chem. Soc.* **1991**, *113*, 1553-1557.
- [9] Wang, C., et al., *J. Org. Chem.* **2014**, *79*, 1571-1581.
- [10] Bakstad, E., *unpublished results*.
- [11] Grinsrød, A., *Master of science (Cand. Scient.) thesis, University of Stavanger* **2005**.
- [12] a) Mainali, S., *Master of science thesis, University of Stavanger* **2011**, b) Lunde, S., *Master of science thesis, University of Stavanger* **2010**.
- [13] Khalid, B., *Master of science thesis, University of Stavanger* **2011**.
- [14] a) Castañeda-Ovando, A., et al., *Food Chem.* **2009**, *113*, 859-871, b) Holton, T. A., Cornish, E. C., *Plant Cell* **1995**, *7*, 1071-1083.
- [15] Iacobucci, G. A., Sweeny, J. G., *Tetrahedron* **1983**, *39*, 3005-3038.
- [16] a) Wang, L.-S., Stoner, G. D., *Cancer Lett.* **2008**, *269*, 281-290, b) Weisel, T., et al., *Biotechnol. J.* **2006**, *1*, 388-397.
- [17] a) Karlsen, A., et al., *Eur. J. Nutr.* **2010**, *49*, 345-355, b) Karlsen, A., et al., *J. Nutr.* **2007**, *137*, 1951-1954.
- [18] Qin, Y., et al., *Am. J. Clin. Nutr.* **2009**, *90*, 485-492.
- [19] Katsube, N., et al., *J. Agric. Food. Chem.* **2003**, *51*, 68-75.
- [20] Whitman, W. B., et al., *Proc. Natl. Acad. Sci. U S A.* **1998**, *95*, 6578-6583.
- [21] Hillman, E. T., et al., *Microbes Environ.* **2017**, *32*, 300-313.
- [22] Wu, H.-J., Wu, E., *Gut Microbes.* **2012**, *3*, 4-14.
- [23] Yano, J. M., et al., *Cell.* **2015**, *161*, 264-276.
- [24] Ligon, B. L., *Semin. Pediatr. Infect. Dis.* **2004**, *15*, 52-57.
- [25] Khachatourians, G. G., *Can. Med. Assoc. J.* **1998**, *159*, 1129-1136.
- [26] Swanson, R. N., et al., *Antimicrob. Agents. Chemother.* **1991**, *35*, 1108-1111.
- [27] Di Bella, S., et al., *Toxins* **2016**, *8*, 134.
- [28] Kaufmann, E., et al., *Org. Lett.* **2015**, *17*, 3514-3517.
- [29] Reynolds, P. E., *Eur. J. Clin. Microbiol. Infect. Dis.* **1989**, *8*, 943-950.
- [30] Jung, H. M., et al., *Appl. Microbiol. Biotechnol.* **2009**, *84*, 417-428.
- [31] Evans, D. A., et al., *J. Am. Chem. Soc.* **2001**, *123*, 12411-12413.
- [32] Wang, H., et al., *The Lancet* **2016**, *388*, 1459-1544.
- [33] Dourmishev, A. L., et al., *Int. J. Dermatol.* **2005**, *44*, 981-988.
- [34] Albers-Schoenberg, G., et al., *J. Am. Chem. Soc.* **1981**, *103*, 4216-4221.
- [35] Campbell, W. C., et al., in *Pesticide Synthesis Through Rational Approaches*, Vol. 255, American Chemical Society, **1984**, pp. 5-20.
- [36] Callaway, E., Cyranoski, D., *Nature* **2015**, *526*, 174-175.
- [37] Danishefsky, S. J., et al., *J. Am. Chem. Soc.* **1989**, *111*, 2967-2980.
- [38] Hanessian, S., et al., in *Progress in Natural Product Chemistry by the Chiron and Related Approaches*, Vol. 59, **1987**, pp. 299-316.
- [39] Ley, S. V., et al., *J. Chem. Soc., Perkin Trans. 1.* **1991**, 667-692.
- [40] White, J. D., et al., *J. Am. Chem. Soc.* **1995**, *117*, 1908-1939.
- [41] Morgan, M. A., Hecht, S. M., *Biochemistry* **1994**, *33*, 10286-10293.
- [42] Takita, T., et al., *Tetrahedron Lett.* **1982**, *23*, 521-524.

Anomeric O-Alkylation as a Diastereoselective Glycosylation Method

- [43] Aoyagi, Y., et al., *J. Am. Chem. Soc.* **1982**, *104*, 5537-5538.
- [44] Hoff, P. M., et al., *Oncologist* **2001**, *6 Suppl 4*, 3-11.
- [45] Shimma, N., et al., *Bioorg. Med. Chem.* **2000**, *8*, 1697-1706.
- [46] Cheaib, R., et al., *Tetrahedron-Asymmetr.* **2008**, *19*, 1919-1933.
- [47] Lee, J. C., et al., *Korean. Chem. soc.* **2003**, *24*.
- [48] Koenigs, W., Knorr, E., *Chem. Ber.* **1901**, *34*, 957-981.
- [49] Igarashi, K., in *Advances in Carbohydrate Chemistry and Biochemistry, Vol. 34* (Eds.: Stuart Tipson, R., Horton, D.), Academic Press, **1977**, pp. 243-283.
- [50] a) Burckhardt, H., Walter, O., *Chem. Ber.* **1962**, *95*, 2612-2615, b) Burckhardt, H., Joachim, Z., *Chem. Ber.* **1962**, *95*, 2604-2611.
- [51] Ashry, I. A. I., et al., *Eur. J. Org. Chem.* **2003**, 4121-4131.
- [52] Klotz, W., Schmidt, R. R., *Liebigs Ann. Chem.* **1993**, 683-690.
- [53] Schmidt, R. R., Kinzy, W., *Adv. Carbohydr. Chem. Biochem.* **1994**, *50*, 21-123.
- [54] Schmidt, R. R., Michel, J., *Angew. Chem., Int. Ed.* **1980**, *19*, 731-732.
- [55] Crich, D., Sun, S., *J. Am. Chem. Soc.* **1997**, *119*, 11217-11223.
- [56] Lian, G., et al., *Carbohydr. Res.* **2015**, *403*, 13-22.
- [57] Hastay, S. J., Demchenko, A. V., *Chem. Heterocyc. Compd.* **2012**, *48*, 10.1007/s10593-10012-10984-10594.
- [58] Arasappan, A., Fraser-Reid, B., *J. org. Chem.* **1996**, *61*, 2401-2406.
- [59] Hotha, S., Kashyap, S., *J. Am. Chem. Soc.* **2006**, *128*, 9620-9621.
- [60] Fischer, E., et al., *Ber. Dtsch. Chem. Ges.* **1920**, *53*, 509-547.
- [61] Ernst, C., et al., *Carbohydr. Res.* **2003**, *338*, 231-236.
- [62] Halcomb, R. L., Danishefsky, S. J., *J. Am. Chem. Soc.* **1989**, *111*, 6661-6666.
- [63] Brigl, P., *Hoppe-Seyler's Z. Physiol. Chem.* **1922**, *122*, 245.
- [64] Danishefsky, S. J., Bilodeau, M. T., *Angew. Chem., Int. Ed.* **1996**, *35*, 1380-1419.
- [65] a) Lemieux, R. U., Fraser-Reid, B., *Can. J. Chem.* **1965**, *43*, 1460-1475, b) Lemieux, R. U., Levine, S., *Can. J. Chem.* **1964**, *42*, 1473-1480.
- [66] Vauzeilles, B., et al., *Tetrahedron Lett.* **2001**, *42*, 7567-7570.
- [67] Peres, R. M., *Master of science thesis, University of Stavanger* **2015**.
- [68] Lee, Y. H., Lin, T. I., *J. Chromatogr. B. Biomed. Appl.* **1996**, *681*, 87-97.
- [69] Feng, S., et al., *J. Phys. Chem. A* **2013**, *117*, 5211-5219.
- [70] McCloskey, C. M., Coleman, G. H., *Org. Synth.* **1945**, *25*.
- [71] Fiandor, J., et al., *Synthesis* **1985**, *1985*, 1121-1123.
- [72] Pravst, I., et al., *Tetrahedron* **2008**, *64*, 5191-5199.
- [73] Håheim, K. S., *Bachelor of science thesis, University of Stavanger* **2016**.
- [74] Schmidt, R. R., et al., *Liebigs Ann.* **1984**, *1984*, 1343-1357.
- [75] Fischer, E., Bergmann, M., *Ber. Dtsch. Chem. Ges.* **1917**, *50*, 1047-1069.
- [76] Baddeley, T. C., et al., *J. Chem. Crystallogr.* **2007**, *37*, 853-858.
- [77] Urdal, I. T., *Master of science thesis, University of Stavanger* **2008**.
- [78] Gunadi, S. H., et al., *Angew. Chem., Int. Ed.* **2009**, *48*, 2723-2726.
- [79] Attanasi, O. A., et al., *Org. Lett.* **2006**, *8*, 4291-4293.
- [80] a) Das, B., et al., *Tetrahedron Lett.* **2005**, *46*, 3041-3044, b) Khan, A. T., et al., *J. Org. Chem* **2006**, *71*, 8961-8963.
- [81] Zakharkin, L. I., Korneva, V. V., *Bull. Acad. Sci. USSR, Div. Chem. Sci.* **1962**, *11*, 1724-1726.
- [82] Peres, R. O., *Master of science thesis, University of Stavanger* **2017**.
- [83] Bakstad, E., *Method for the synthesis of anthocyanins*, **2013**, 8513395
- [84] Lee, J. C., et al., *Synth. Commun.* **2004**, *34*, 2095-2099.
- [85] Naimak, J., *Unpublished results*.
- [86] Utamura, T., et al., *Chem. Pharm. Bull.* **1986**, *34*, 2341-2353.

Anomeric O-Alkylation as a Diastereoselective Glycosylation Method

Appendix

Compounds

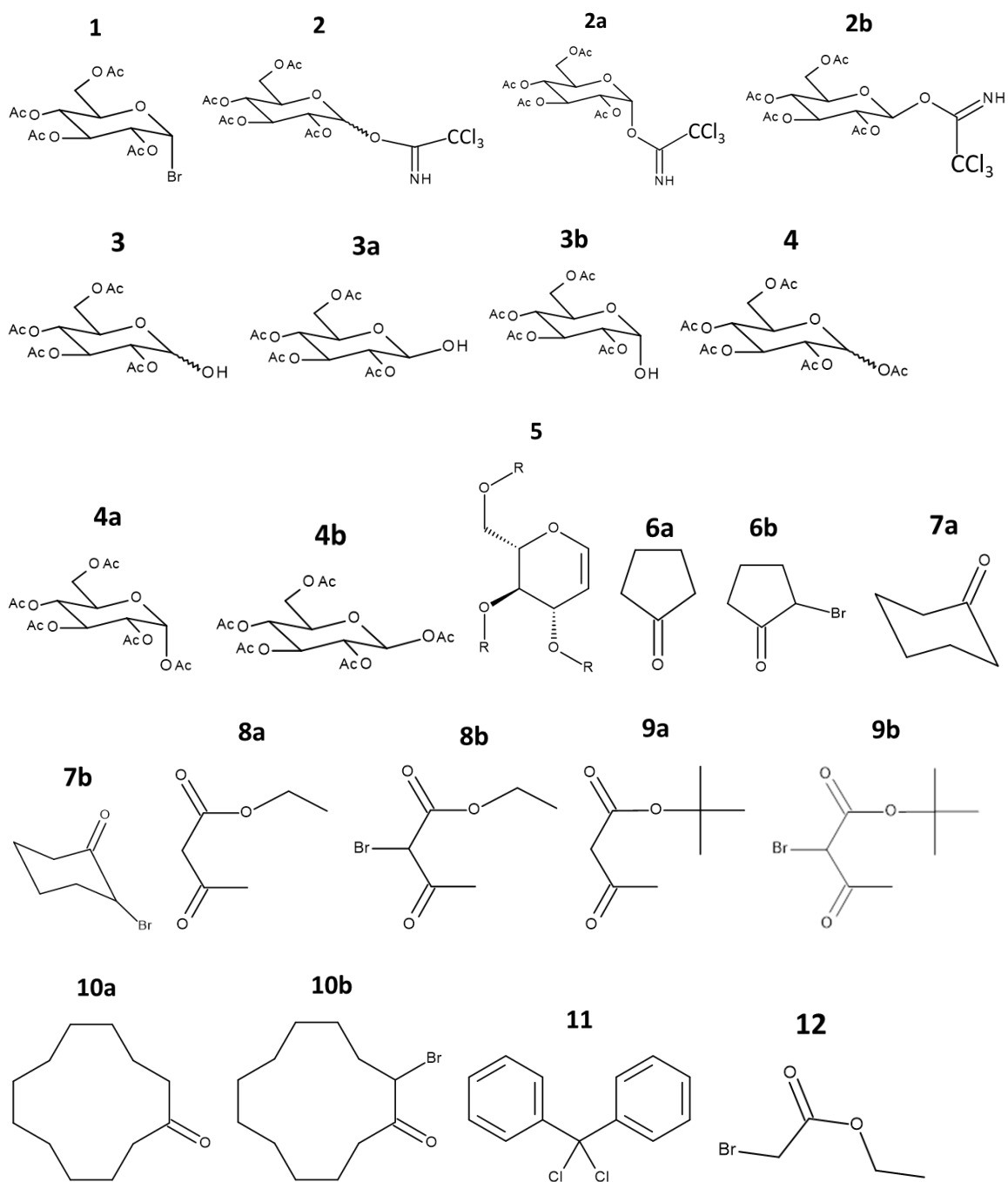

Anomeric O-Alkylation as a Diastereoselective Glycosylation Method

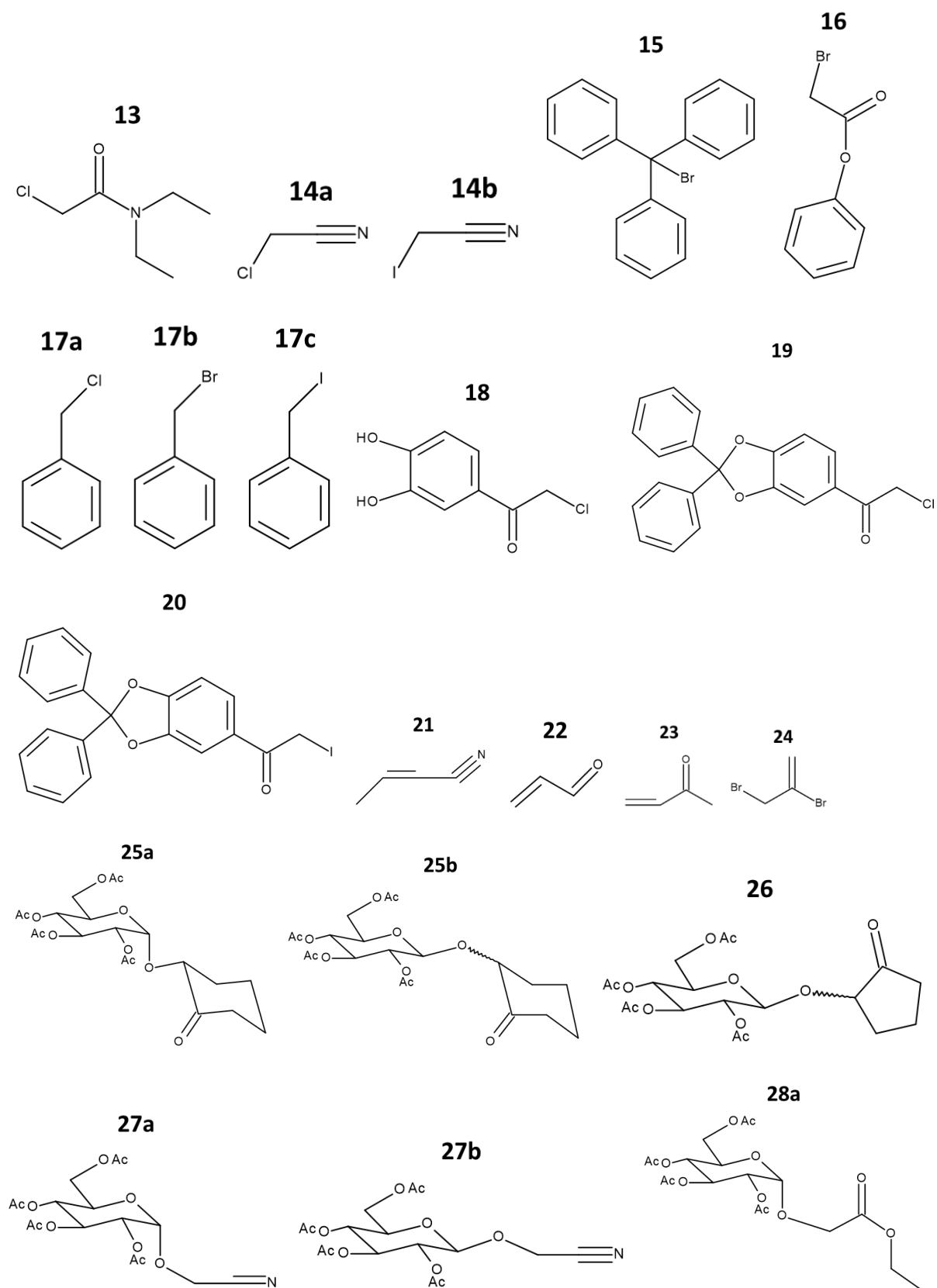

Anomeric O-Alkylation as a Diastereoselective Glycosylation Method

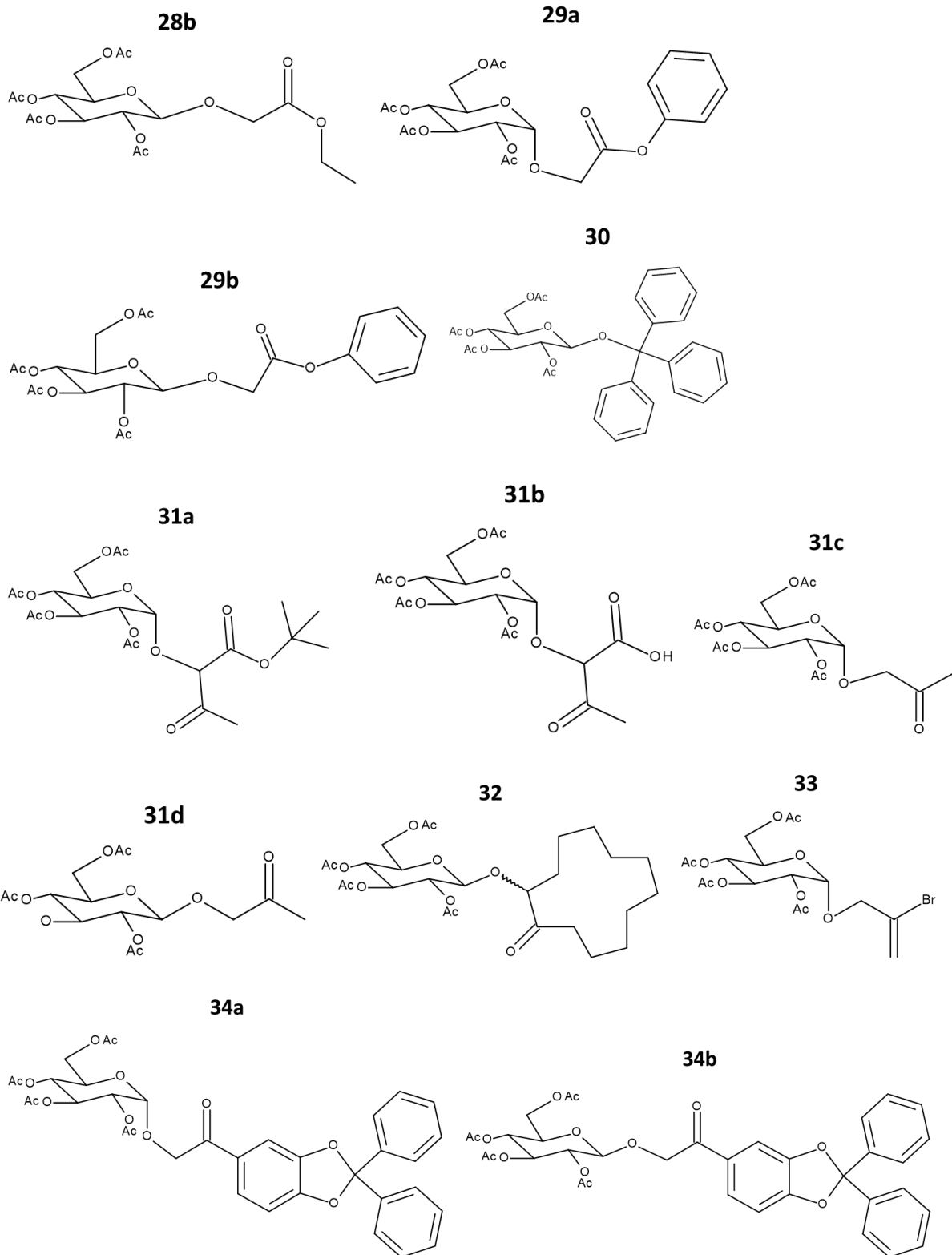

Abbreviations

Ac: Acetyl

Anisaldehyde: *Para*-methoxybenzaldehyde

Bn: Benzyl

DBU: 1,8-Diazabicyclo[5,4,0]undec-7-ene

DCM: Dichloromethane

DFC: Dry flash chromatography

DMDO: Dimethyldioxirane

DME: Dimethoxyethane

DMF: *N,N*-dimethylformamide

DMSO: Dimethylsulfoxide

Et: Ethyl

et al.: and others

Et₃N: Triethylamine

Et₂O : Diethylether

E1: Elimination of leaving group pathway 1, where leaving group leaves and elimination reaction takes place afterwards.

E2: Elimination of leaving group pathway 2, where leaving group leaves as a consequence of an elimination reaction.

FC: Flash chromatography

HPLC: High performance liquid chromatography

in situ: On site

IR: Infrared

J: Coupling constant (NMR)

Me: Methyl

MeCN: Acetonitrile

MHz: Megahertz

M.p: Melting point

NBS: N-Bromosuccinimide

NMR: Nuclear magnetic resonance

N-glycoside: Molecule connected to a sugar molecule by a nitrogen group.

OBn: Benzyloxy

OMe: Methoxy

Anomeric O-Alkylation as a Diastereoselective Glycosylation Method

O-glycoside: Molecule connected to a sugar molecule by an oxygen group.

PG: Protecting group

Ph: Phenyl

ppm: Parts per million

R_f: Retention factor

R.T.: Room temperature

R-group: A variable group often with a suffix (R_x) denoting which one

SN1: Nucleophilic substitution pathway 1, where leaving group leaves prior to nucleophilic attack.

SN2: Nucleophilic substitution pathway 2, where leaving group leaves as a consequence of nucleophilic attack.

S-glycoside: Molecule connected to a sugar molecule by a sulfur group.

TBME: *Tert*-butyl methyl ether

TLC: Thin-layer chromatography

p-TsOH: *Para*-toluenesulfonic acid

UV: Ultra violet