



Universitetet
i Stavanger

FACULTY OF SCIENCE AND TECHNOLOGY

MASTER'S THESIS

Study program/specialization: Master of Science in Petroleum Engineering/ Drilling Engineering	Spring semester, 2020. Open access
Author: Elsayed Eid	<hr/> (Author's signature)
Supervisor(s): Dr. Mahmoud Khalifeh Dr. Kris Ravi	
Title of master's thesis: Identification and Analysis of Retarders for Geopolymer Designed for Well Cementing	
Credits: 30 ECTS	
Keywords: Geopolymer Activator Retarders Aluminum silicates Inorganic polymers	Number of pages: XII + 71 + supplemental material/other: 0 Stavanger, 15th June 2020

**Identification and Analysis of Potential Retarders for Geopolymers
Designed for Well Cementing**

By
Elsayed Eid

Master's Thesis
Presented to the Faculty of Science and Technology
The University of Stavanger

THE UNIVERSITY OF STAVANGER

JUNE 2020

Acknowledgement

I would like to thank Safe Rock Project and its industrial partners, TOTAL and Aker BP for supporting the project financially and allowing me to publish the results.

I would like to express my sincere gratitude to my supervisor, Dr Mahmoud Khalifeh, at the University of Stavanger, who has provided me with invaluable help and motivation throughout my project. Also, I would like to thank PhD student Mohammadreza Kamali for letting me take part in his work, his help and guidance. It has been a pleasure and an honor to work with him.

I would like to thank my supervisor at the Montan University of Leoben, Dr Kris Ravi, for his insightful comments, kind supervision and encouragement. I truly appreciate his help and guidance during these months.

Final thanks to all my friends and colleagues who encouraged and supported me to achieve my goals.

Abstract

Ordinary Portland cement (OPC) is the primary material, which is used in oil well cement, isolation formation and plug and abandonment. OPC has many advantages and some limitations reviewed by different authors. The limitations associated with cement cause well integrity issues, risking humans, and environment. Several studies and experiments are conducted to evaluate different materials, which could be an optimal alternate to OPC. Geopolymer is one of these materials, which has been tested in lab scale to find its potential to replace OPC.

Geopolymers are inorganic materials based on rock sources, which are rich in aluminum silicates. Many pieces of research have conducted on the geopolymer to assess its characteristics and properties. Studies showed that geopolymer is a ductile and low shrinkage material. It develops sufficient bond strength, high compressive strength and less fluid loss comparing to OPC. However, studies showed some shortcomings of geopolymer, which should be enhanced to allow using the geopolymer in the oil field.

The pumpability at elevated temperatures, for a certain period, is one of the current limitations of the geopolymer. Several experiments have been performed to get the proper compositions of the geopolymer and the appropriate retarding admixture, which help to increase the pumping time of the geopolymer paste. Chemical S&H revealed its potential to retard the setting time by 80 mins. It is proved that there many parameters, which control the setting time of the sample. The modular ratio, weight of the admixture and composition of the precursors, have an impact on delaying the thickening time. BS2 is more pumpability than BS1, and S7 is the sample which has the most significant pumping time among the others.

Results from the uniaxial compressive test (UCS) and ultrasonic cement analyzer (UCA) show the compressive strength value is in an acceptable range for utilization in oil well cementing. Rheology properties of geopolymers were characterized as non-Newtonian shear-thinning fluid and its density within the permissible range (1.95 sg). These characteristics promote the geopolymer to be a good quality alternative material to be applied in downhole applications.

Acronyms

Al ₂ O ₃	Aluminum Oxide
API	American Petroleum Institute
ASTM	American Society for Testing and Minerals
ATM	Atmosphere
BHCT	Bottom Hole Circulation Temperature
BFS	Blast Furnace Slag
CaCO ₃	Calcium Carbonate
Ca (OH) ₂	Calcium Hydroxide
CO ₂	Carbon dioxide
GBFS	Granulated Blast Furnace Slag
HSE	Healthy, Safety and Environment
H ₂ S	Hydrogen Sulfide
KOH	Potassium Hydroxide
K ₂ SiO ₃	Potassium Silicate
MPa	Mega Pascal
MSc	Master of Science
Na ₂ CO ₃	Sodium Carbonate
Na ₂ O	Sodium Oxide
NaOH	Sodium Hydroxide
Na ₂ SiO ₃	Sodium Silicate
OBM	Oil Base Mud
PSA	Petroleum Safety Authority
P&A	Plug and Abandonment
SiO ₂	Silica
UCA	Ultrasonic Cement Analyzer
UCS	Uniaxial Compressive Strength
UiS	University of Stavanger

List of Contents

Acknowledgement.....	iii
Abstract	iv
Acronyms	v
List of Contents	vi
List of Figures	x
List of Tables.....	xii
1. Introduction	13
1.1 Problem statement	14
1.2 Alkali Activated Based Cement (AABC) are not Geopolymer	15
2. Objectives of This Study	16
2.1 Scope of the study	16
3. Literature Review	17
3.1 Geopolymer Cement	17
3.2 Synthesis of Geopolymer	18
3.3 Geopolymerization Mechanism	23
3.4 Geopolymer Binder Constituents	24
3.4.1 Raw Materials	24
3.4.1.1 By Product Materials.....	25
3.4.1.2 General and Recycled Materials.....	25
3.4.1.3 Natural Materials.....	25
3.4.1.4 Geopolymer Precursors	26
3.4.2 Alkaline activator	26
3.4.2.1 Potassium Hydroxide	26
3.4.2.2 Potassium Silicate	27
3.4.2.3 Deionized Water.....	27
3.5 Design of Geopolymer Mesh	27

3.5.1 Alkaline Activator Concentration	27
3.5.2 The Modular Ratio ($\text{SiO}_2/\text{K}_2\text{O}$).....	28
3.5.3 Alkaline Activator/Aluminosilicates Source.....	28
3.5.4 M/Al Ratio.....	29
3.5.5 Water Content	29
3.5.6 Curing Temperature	30
3.5.7 Curing Time	30
3.5.8 Silica/Alumina Ratio	30
3.6 Characterization of Geopolymer Properties	32
3.6.1 Setting Time	32
3.6.2 Flowability	32
2.6.3 Mechanical Properties	32
3.6.4 Shrinkage.....	33
3.6.5 Durability	33
3.6.6 Acid Resistance	33
3.6.7 Thermal Resistance	34
3.6.8 Porosity.....	34
4. Retarding Admixtures for Geopolymer – State of the Art.....	35
4.1 Reaction Mechanism of The Set Retarding Admixture	35
4.1.1 Adsorption.....	36
4.1.2 Precipitation	36
4.1.3 Complexation	36
4.1.4 Nucleation	36
4.2 Water Reducer, Retarders and Superplasticizers	36
4.2.1 Water Reducing Admixture (WRA)	37
4.2.2 Superplasticizers (SP)	37
4.2.3 Retarding Admixtures	38

4.3 The Nature of Retarders	38
4.3.1 Lignosulphonates	39
4.3.2 Sugars	40
4.3.3 Hydroxycarboxylic Acids and Salts	41
4.3.4 Inorganic retarders.....	42
4.3.4.1 Phosphates	42
4.3.4.2 Potassium Dihydrogen Phosphate	42
4.3.4.3 Sodium Dihydrogen Phosphate Dihydrate (NaH ₂ PO ₄ ·2H ₂ O).....	42
4.3.4.4 Phosphonates	42
4.3.4.5 Borax (Na ₂ B ₄ O ₇ ·10H ₂ O)	42
4.3.4.6 Barium chloride dehydrate (BaCl ₂ ·2H ₂ O)	43
5. Methodology	44
5.1 Materials	44
5.2 Equipment	48
5.2.1 Mettler Toledo Scale	48
5.2.2 OFITE Model Commercial Blender.....	48
5.2.3 Hamilton Beach Mud Mixer	49
5.2.4 Molds.....	51
5.2.5 Atmospheric Consistometer	51
5.2.6 Cutting Machine	52
5.2.7 Hydraulic Press Machine	53
5.2.8 UCA	53
5.3 Mixing Procedures	54
5.4 Conditioning of the slurry	54
5.5 Mechanical Characteristics	55
5.5.1 Demolding and Cutting	55
5.5.2 Mechanical Testing	56

5.5.2.1 UCA	56
5.5.2.2 UCS	56
5.5.2.3 Brazilian Test	58
5.6 Pumping Time	59
6. Results and Discussions	60
6.1 Atmospheric Consistency Experiments	60
6.2 Mechanical Test Results.....	65
6.3 Uniaxial Cement Analyzer (UCA) Results	68
6.3 Rheology results	69
7. Conclusion.....	71
8. References	73

List of Figures

Figure 3-1 Type of Poly-Sialate Structures	17
Figure 3-2 Geopolymerization Process	19
Figure 3-3 The Different Structures of Oligomers	20
Figure 3-4 Structural Models of Approximately 200 Atoms	21
Figure 3-5 The Structure of Sodium Based Geopolymer	22
Figure 3-6 The Output of Geopolymerization	22
Figure 3-7 The Output of Geopolymerization	24
Figure 3-8 Compressive Strength vs Type of Materials	26
Figure 3-9 The Effect of Ratio of $\text{SiO}_2/\text{Al}_2\text{O}_3$	31
Figure 4-1 The Setting and Hardening Effect on The Heat Evolution	39
Figure 4-2 The Chemical Structure of Sucrose	41
Figure 5-1 Mettler Toledo Scale	48
Figure 5-2 OFITE Model Commercial Blender	49
Figure 5-3 Hamilton Beach Mud Mixer	50
Figure 5-4 The Shape of The Mixer and Commercial Blender Respectively from Left to Right	50
Figure 5-5 Plastic Mold	51
Figure 5-6 Atmospheric Consistometer	52
Figure 5-7 Cutting Machine with Diamond Blades	52
Figure 5-8 Ultrasonic Cement Analyzer	53
Figure 5-9 The Compressive Strength Machine	57
Figure 5-10 The Crushed Sample from uniaxial compressive strength test	57
Figure 5-11 The Tensile Strength Machine	58
Figure 5-12 The crushed Sample from Indirect Tensile strength test	58
Figure 5-13 The Behavior of The geopolymer Paste during The Conditioning	59
Figure 6-1 The Effect of Different Retarders on The Pumping Time	60
Figure 6-2 The effect of mix design on the setting time	61
Figure 6-3 The impact of different recipes of the precursor	62
Figure 6-4 The Impact of Various Retarding Admixtures on The Thickening time	62
Figure 6-5 The Result of Others Retarding Admixtures	63
Figure 6-6 The Consequence of Using Different Modular Ratio on The Consistency	64
Figure 6-7 The Effect of Using chemical W instead of chemical O	64

Figure 6-8 The Result of curing condition (under Atm Pressure).....	66
Figure 6-9 The Consequences of Gas Bubbles on Curing	66
Figure 6-10 Uniaxial compressive strength results after 7 days of curing at 90°C and 2500 psi.	67
Figure 6-11 Tensile strength results from Brazilian test after 7 days of curing at 90°C and 2500 psi.	68
Figure 6-12 The Compressive Strength Results from UCA by Using A generated Algorithm.	69
Figure 6-13 The Result of Compressive Strength from UCS after 7 days of curing at 90°C and 2500 psi.	69
Figure 6-14 The Results of The Rheology properties of Geopolymer by Herschel- Buckley model.....	70
Figure 6-15 The Results of The Apparent Viscosity of Different Geopolymer Samples	70

List of Tables

Table 4-1 The Types of Retarding Admixture	39
Table 4-2 Reducing and Non-reducing Sugar	40
Table 5-1 The Compositions of The Base Reference Sample (BS1)	44
Table 5-2 The Chemistry of Precursor for BS1	45
Table 5-3 The Chemicals and the Weight of Different Retendering Admixtures	45
Table 5-4 The Recipe of The Second Base Sample (BS2)	45
Table 5-5 The Chemistry of The Precursor of BS2	46
Table 5-6 The Type and Weight of The Retarding Admixture	46
Table 5-7 The Recipe of A number of Samples with Different Modular Ratio	47
Table 5-8 The Recipe of Specimen S11*	47
Table 6-1 The Initial and Final Setting Time of The Samples	60

1. Introduction

In drilling operations, when a well reaches a predetermined depth, the operation is continued by running the casing to its depth. Once it is set, the cementing process is started by circulating the drilling mud with a new one to remove and clean any debris between the casing and the formation. A spacer is used between the cement and the mud to avoid the contamination while pumping the cement inside the hole up to the annulus. The process is finished when the cement is taken its place around the casing.

Portland cement was used in an oil field for the first time at the Lompoc field in California. It was used by Frank Hill to isolate a water zone (Andini et al., 2008). Cement is manufactured from binding materials, which are ground into a fine powder and then mixed with water to form a solid mass. Cement has been used widely in oil fields for primary cementing and permanent plug and abandonment. In primary cementing operations, cement is functioned to provide zonal isolation, hold the casing in place and protect the casing from corrosive fluid, when the next sections of the well are drilled. The material used for cementing operation should fulfil the requirements to secure both the remaining drilling operation and production period. The standard specifications of cement are divided into two types, i.e., short- and long-term specifications (Helland, 2013). Portland cement has been divided into nine classes according to the American petroleum institute (API), each of which is utilized for different depth and conditions. In drilling operation in the petroleum industry, class G and H are the most commonly used cement types.

Ordinary Portland Cement (OPC) is the most used material in the industry, owing to its commercial availability, accessibility and being friendly to use in operations (Khalifeh, Hodne, et al., 2016). However, it has shown shortcomings during the lifetime of the well. Variations in downhole pressure and temperatures could generate stresses which may damage the cement sheath and result in wellbore failure (Jackson & Murphey, 1993). Subsequently, a very small micro-annuli is created due to shrinking and debonding of the cement sheath, allowing fluid and gas migration. Besides these external forces, assessments were made at the nanoscale level revealed that chemical bonds between cement elements are relatively brittle. Sustained casing pressure is one of the results of cement bond failure or inadequate mud removal. About 8000 wells have reported this issue in the Gulf of Mexico (Bakharev, 2005). Besides, the emission of CO₂ during the production of cement can have a negative impact on climate change. Portland

cement processing produces approximately one ton of CO₂ which contributes to global warming (Hendriks et al., 1999).

Several materials have been studied and tested to replace OPC. Some of them have shown good results, such as unconsolidated sand slurry, thermosetting polymers, and geopolymers (Beharie et al., 2015; Khalifeh et al., 2014; Vrålstad et al., 2019)

Geopolymers are a category of cementitious inorganic materials, which were first introduced by Joseph Davidovits in 1978. Geopolymers can form long-chain of molecules by Alkalinization of aluminosilicates-based material. Geopolymers have shown great attributes in lab scales, such as high compression strength, long-term durability, high corrosion resistance and sulfate attack. Hence they can be considered as a potential for using in primary cementing (Khalifeh, Hodne, et al., 2016; Khalifeh, Saasen, et al., 2019; Khalifeh, Salehi, et al., 2019; Saeed Salehi et al., 2019; Xu & van Deventer, 2003).

The flexibility of geopolymer has been studied in the construction industry, where some organic polymer additives are used to improve properties such as workability, setting time and mechanical strength (Shrotri et al., 2009). Organic admixture can increase the setting time and the workability without affecting the long-term mechanical properties of the concrete (Mailvaganam et al., 1999). However, the problem of low workability and rapid setting time is the reason that geopolymer has not been tested in the oilfield yet. Several studies have been conducted to increase the setting time of geopolymers without affecting other properties. Some of them work on change in the composition of the solid phase and hardeners, and others work on discovering retarders to delay the reaction.

1.1 Problem statement

The geopolymer has not been used alone in the oil field until now, where its application is still in the R&D phase (Saeed Salehi et al., 2017). It showed good results when it is used to replace around 60 % by weight of cement, where the mixture of cement and aluminosilicates is used as a lightweight lead cement in intermediated casing operation (Mahmoudkhani et al., 2008). All researchers showed that the geopolymeric slurry sets so quickly at elevated temperature, which results in decreasing the workability of the geopolymer. Additionally, studies revealed the low tensile strength of the binder as it is brittle (Raijiwala & Patil, 2010). Some researchers recommend using additives to solve this issue and work on improving its properties (Kusbiantoro et al., 2013; Shalbfafan & Thoemen, 2020). One of these experiments which have been run on GGBFS with using sucrose as a retarder displayed an increase in the

setting time and compressibility of the samples but the tensile strength of geopolymer has declined (Khalifeh et al., 2014). Others have been performed on fly ash-based geopolymers and with different alkaline activators. They showed an increase in the compressive strength by using barite throughout a curing time of 7 days. However, barite does not have any effect on curing days for more than one week (Paiva et al., 2018).

1.2 Alkali Activated Based Cement (AABC) are not Geopolymer

During the last few years, due to greenhouse gas emission concerns, researchers have been trying to develop alternative to Portland cement. Geopolymers have been one of such technologies which might have the potential to replace cement. Therefore, several researchers and engineers have been doing research, with high pace, on geopolymers and AABC materials. Consequently, most of concept and theories got mixed and thus contradictory research results have been published. In addition, the lack of good understanding and scientific distinguishing between geopolymers and AABC caused delaying the commercialization of geopolymers in global scale. An example could be defining a chemical as retarder to geopolymers and when other researcher tried to reproduce the results, it was impossible. The reason is that the developed retarder was for AABC and not geopolymers. So that, the reliability on geopolymers have been being questioned.

Geopolymer technology is not the same as AABC technology. Some studies have been conducted on alkali-activated based cements, alkali-activated fly ash cement, alkali-activated slag and slag based, fly ash-based or natural rock-based geopolymers. They revealed that AABC has different chemistry and molecular structure than geopolymer. The chemical reaction of AABC will result in forming a complicated structure, which contains Calcium Aluminum Silicate Hydrate (C-A-S-H) gels and alkali cation K^+ or Na^+ . Alkali cation exists on the outside of the structure. So, it is merely for alkali cation to move fast in contact with water and results in unstable structure and therefore insufficient long-term properties (Joseph Davidovits, 2011; Joseph Davidovits et al., 2019; Zhang et al., 2011).

On the other hand, the geopolymerization process will continue by adding a networking element, which will interact with the free alkali cations and leads to forming a stable 3D networking structure. The geopolymerization reaction produces Sodium or Potassium Aluminum Silicate Hydrate (known as Na (K)-A-S-H) gels. Due to low calcium content of the final product, and placement of Na^+ or K^+ inside the 3D network, the materials are stable and durable.

2. Objectives of This Study

The research studies showed that the geopolymer has the potential to be used in primary cementing operation as it is pumpable and can be solidified behind the casing and form a barrier. In this project, we will focus on enhancing the properties of geopolymer to remove its limitations. This thesis will work on these quantifiable aspects:

- Control the geopolymerization reaction and thus improve the thickening time
- Characterize the short-term mechanical properties of the slurries.

2.1 Scope of the study

- Manage the reaction of the solid phase, hardener, and additives by working on:
 - The procedures of mixing design.
 - Using the optimum amount and ratio of both solid and liquid phases.
 - Develop the right additive that will help to postpone the reaction for real-life applications and thus, delaying the thickening time.
- Characterization of the early strength development of the geopolymer:
 - Uniaxial compressive strength
 - Indirect tensile strength (Brazilian test)
- Spotting the optimum geopolymer mixture which affords the best performing and characteristics.

3. Literature Review

3.1 Geopolymer Cement

Geopolymer is a network structure of aluminum and silicate that has binding properties (Khalifeh et al., 2014). It is the output of the polycondensation process where Synthetic materials made from aluminosilicate interact with alkaline solutions. Geopolymer consists of two phases (Dimas et al., 2009; Saeed Salehi et al., 2017; Zhu & Yao, 2013):

- Solid phase: source materials are rich in aluminum and silicates such as kaolinite, clays, zeolite, fly ash, slag, rice husk ash, etc.
- Liquid phase or the hardener: the most commonly used as an alkaline activator is sodium metasilicates or potassium metasilicates.

However, some researches revealed that a geopolymer is not produced from alkali solution where the output from this alkaline solution is alkali-activated based material (Fernando et al., 2010). The structure of the geopolymer has three primary forms based on the molar ratio of Si/Al, poly sialate, poly sialate-silox and poly sialate-disilox as it is shown in Figure 3-1 (Liew et al., 2016).

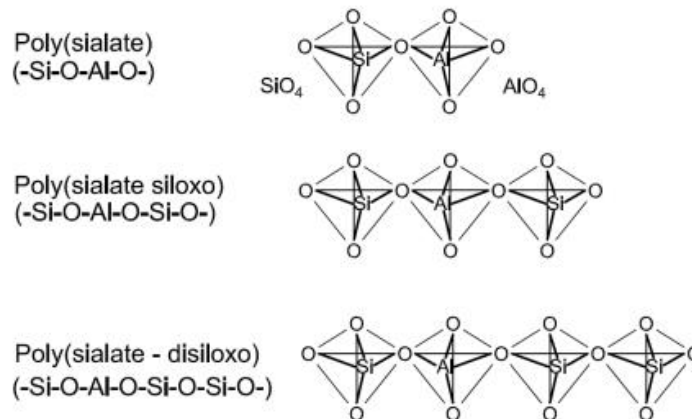

Figure 3-1 Type of Poly-Sialate Structures (J Davidovits, 1991; Liew et al., 2016)

The alkali solutions work on activating aluminum and silicate to form the geopolymer structure according to this formula; $M(_ [SiO_2] _ q _ AlO_2 _) _ n$.

Where M, n and q are respectively alkaline cation, a degree of polycondensation, and Si/Al ratio.

Generally, the chemical reaction of the fabricated inorganic polymer under alkaline conditions results in a 3D polymeric chain structure (Provis & Deventer, 2009; Provis & Rees, 2009; White et al., 2013). This structure contains aluminum and silicate. aluminum comes out from the chemical reaction of aluminosilicates (such as fly ash, metakaolin) in the alkaline media while silicate gets out from dissolved silica and aluminosilicate reactant. Alkaline activator is formed by either dissolution of silica in an alkali hydroxide solution or by adjusting the composition of this water glass (Babushkin et al., 1985). Many parameters control the microstructure and mechanical properties of geopolymers such as natural raw material, composition, and concentration of alkaline activators. It is essential to mention that geopolymer binders are manufactured from waste materials consisting of aluminosilicates, which are the deposits of agriculture and industries (J Davidovits, 1991). The economic and environmental effects are the significance of the geopolymer to be the alternative of OPC.

3.2 Synthesis of Geopolymer

In a condition, a monolithic amorphous is created due to the geopolymerization of aluminosilicates source and alkali solutions at ambient temperature. Many researchers are working on studying the geopolymerization to understand the nature of the reaction, but it is still unclear (Autef et al., 2013; Rees et al., 2008). Figure 3-2 shows the first mechanism of geopolymerization, which is developed by Babushkin, where he divided the process into four steps as following (Babushkin et al., 1985):

- Dissolution of aluminum and silicates in alkali solutions
- Monomers react together and form oligomers
- Polycondensation of these oligomers results in polymeric gel
- Reorganization and polymerization are the final steps to form geopolymer.

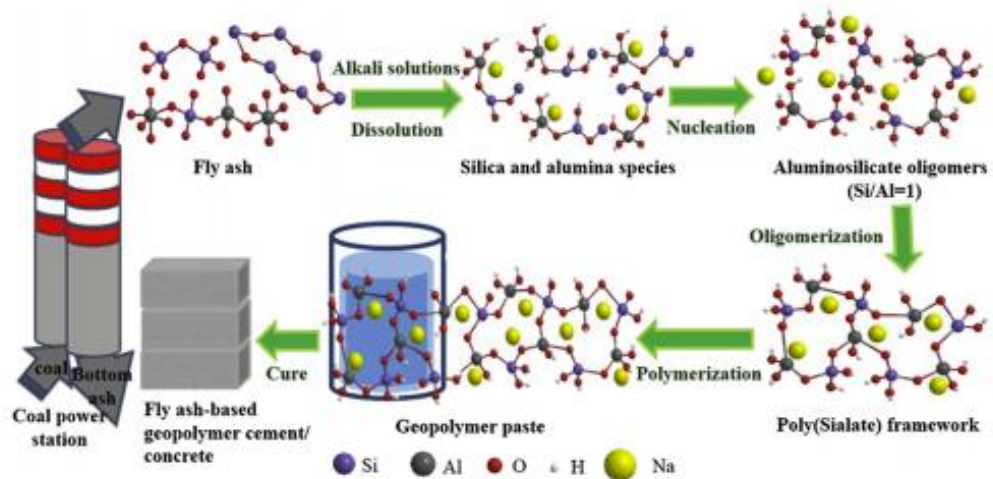

Figure 3-2 Geopolymerization Process (Babushkin et al., 1985)

The geopolymerization is the chemical reaction of the alkali solution with aluminosilicates-based material. The cycle leads to a 3D polymer network and loop framework made up of Si-O-Al-O bonds, and its response is considered energy-efficient and much cleaner as it can occur at ambient temperature (Duxson et al., 2006; Rooses et al., 2013). In the first phase of the reaction, Si—O—Si and Si—O—Al is formed through the hydrolysis of aluminosilicates into alkaline solutions by the action of hydroxide ions (Duxson et al., 2006; Provis & Deventer, 2009). Precursor ions could be converted into monomers where Si^{+4} is partly replaced by Al^{+3} , allowing the bonding with a positive charge from the solution (Na^+ or K^+) to reach the equilibrium state. This reaction pointed out that water is eliminated during polymerization, contrary to the hydration of OPC where water is consumed. The reaction of monomers together results in oligomers with different structures during the process of nucleation. Different size and charge densities result in various alkaline cations affecting the crystallization and formation of aluminosilicate chains leading to improvements in the rate and degree of polymerizing. For instance, K^+ cation has a large sizer and lower charge density than Na^+ , which results in a higher degree of polymerization. In general, oligomers are small molecules and considered the main unit to form the geopolymer (Joseph Davidovits, 2011; Duxson et al., 2006). Figure 3-3 shows the different structures of oligomers (Provis & Deventer, 2009).

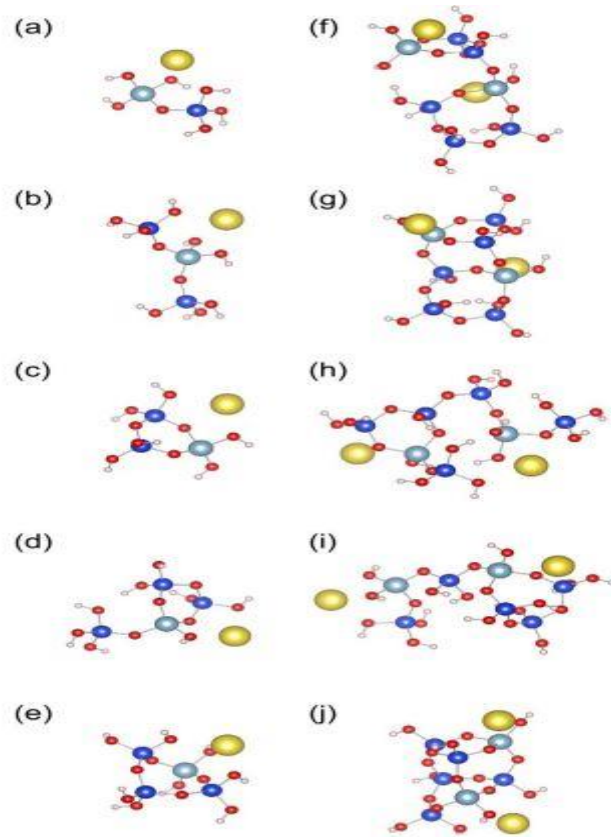

Figure 3-3 The Different Structures of Oligomers (Provis & Deventer, 2009)

Further, oligomers (SiO_4 , AlO_4 with different structures depending on the molar ratio of Si/Al) bond together through the process of polymerization to form the paste of geopolymer. Finally, the setting and hardening of the geopolymer are developed by curing this slurry (Duxson et al., 2006; Zhu & Yao, 2013). Despite much research on geopolymer, the exact mechanism of geopolymerization is still not well known. Besides, they could not define a structural model for the product of geopolymerization. The reason for that could relate to its amorphous nature. Many spectroscopic methods and theoretical models have been used to suggest the innovative structure of geopolymers in addition to using ab initio DFT calculations, Koleżyński et al. made the proposed structure model as it is shown below in Figure 3-4 (Koleżyński et al., 2018):

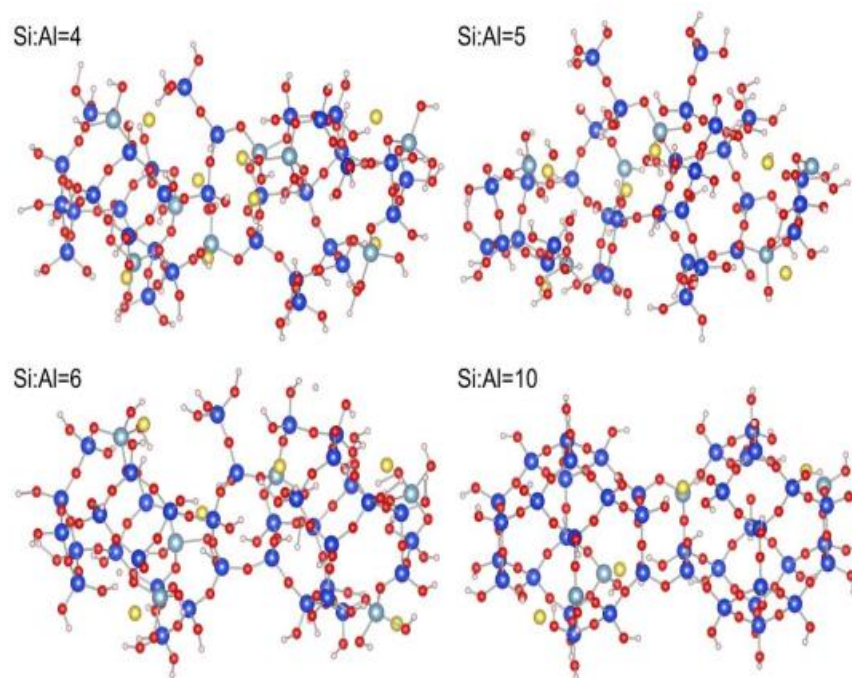

Figure 3-4 Structural Models of Approximately 200 Atoms (Koleżyński et al., 2018)

The Si/Al ratio should always be more significant than 1 to avoid unwanted energy according to the Loewenstein avoidance rule in aluminosilicates where two aluminum ions cannot be bonded directly by a hydrogen ion. NMR study determined that some low stability bonds like Al-O-Al could be present for a low Si/Al ratio, which might weaken the durability and corrosive resistance of geopolymer. The equilibrium state of the system comes from the existence of alkali ions (positive charge), which balance the negative charge of aluminates. These cations are hydrated, forming a sphere depending on the presented element in the structure (Na, K, Rb or Cs). Figure 3-5 shows the structure of a sodium-based geopolymer.

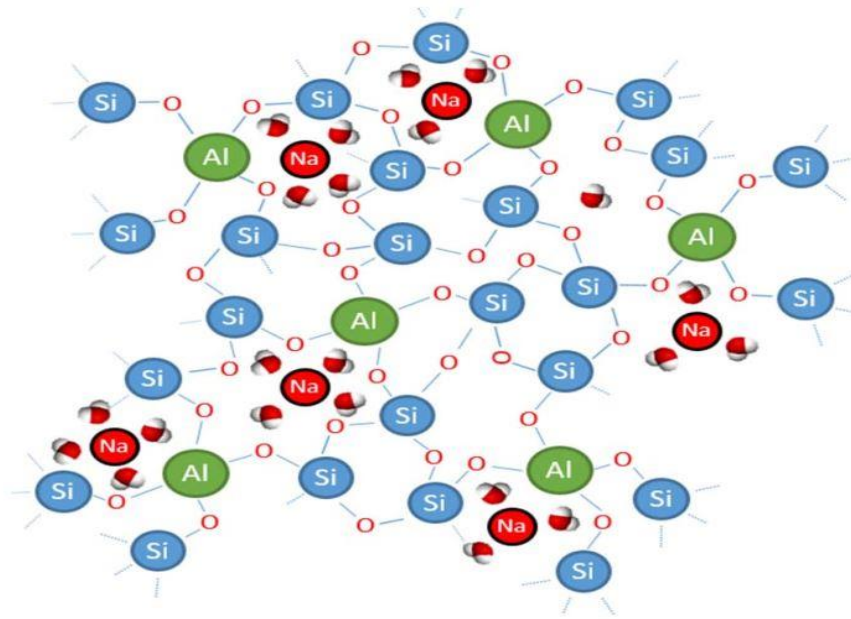

Figure 3-5 The Structure of Sodium Based Geopolymer (Barbosa et al., 2000)

Figure 3-6 has been proposed to represent the output of geopolymerization where the surface of aluminosilicates gets corroded from the reaction with the alkali solution (Ryu et al., 2013).

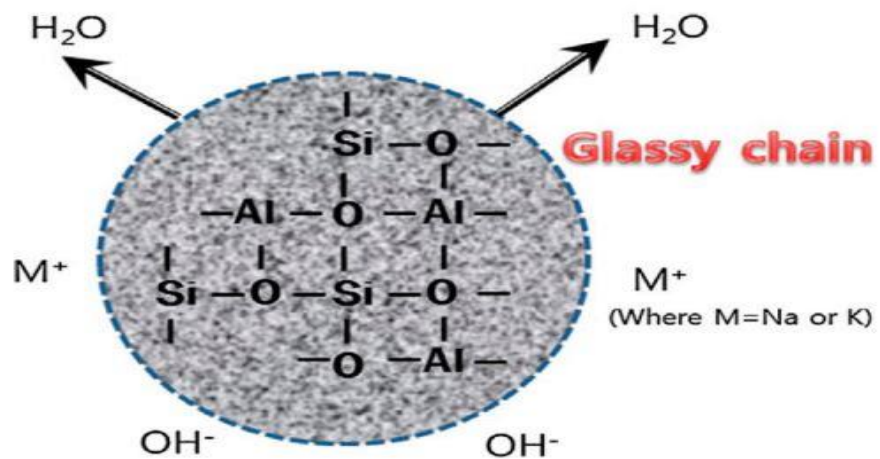

Figure 3-6 The Output of Geopolymerization (Ryu et al., 2013)

3.3 Geopolymerization Mechanism

According to some works of literature, there are five categories of aluminosilicates terminology based on the Si/Al atomic ratio (J Davidovits, 1991). When this ratio Si/Al is equal to 0, the structure is called siloxo. Sialate is the product category if this fraction is around 1 while sialate-siloxo and sialate-disiloxo are domains when Si/Al is equal to 2 and 3, respectively. Sialate link is for all values more than 3. There are a large number of parameters, which control and manage the geopolymerization process, for instance:

- Source of raw material and its surface area
- Amount of aluminum and silicate in the binder
- Curing parameters time, temperature, and pressure
- Curing method (Conventional or microwave heating)
- Kind and intensity of alkali solution
- The ratio of the liquid phase to solid phase & rate of water to solid
- Si/Al, M/Si, H₂O/M

All studies revealed that the rate of geopolymerization increases as the curing time increases. Rising in curing temperature up to 90 °C will lead to a rise in the level of geopolymerization. Alkali concentration work on improving the geopolymerization process where growth in the concentration of alkali results in boost the rate of geopolymerization. The type of alkali will affect the process as well, whereas using Na instead of K will boost up the process and enhance the mechanical strength. On the other hand, the rise in the ratio mentioned above will work on declining the geopolymerization, which results in a decrease of the compressive strength, see Figure 3-7 (Ryu et al., 2013).

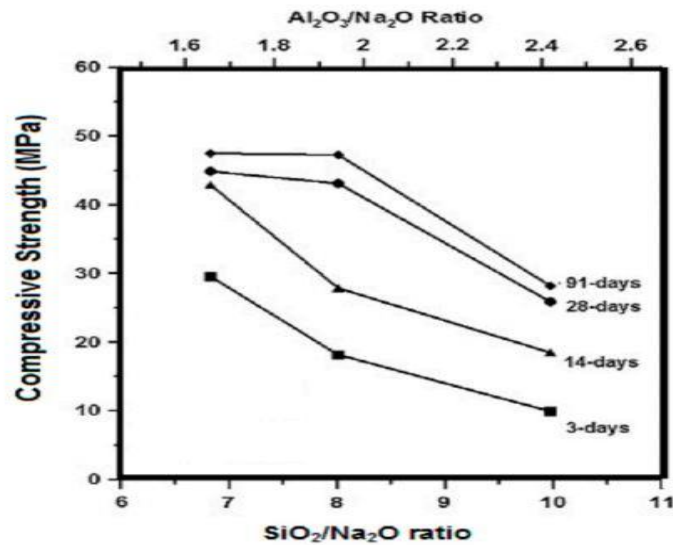

Figure 3-7 The Output of Geopolymerization (Ryu et al., 2013)

Many researchers have been conducted to find the optimum value for these ratios. One of the studies has been found these values 0.25, 10, 3.3 for M/Si, H₂O/M, Si/Al respectively to get the best performance of the geopolymerization process (Barbosa et al., 2000).

3.4 Geopolymer Binder Constituents

The geopolymer is the output of two elements, raw material, and alkali solution. Both of them are the main elements of the geopolymer slurry. However, some of the additives could be used to improve the properties of the slurry.

3.4.1 Raw Materials

Raw substantial is the source that is used as a binder to produce a geopolymer. The source material should be rich in aluminum and silicates to be eligible to be a binder. There are many studies that have been done on different materials to evaluate them if they could be a good raw material of geopolymer or not. Depending on these researchers, they categorized these sources into three main groups. Each one of them has unique characteristics, and the selection among them to be used depends on availability, cost, and applications.

- Industrial waste
- General waste and recycle materials
- Nature materials

3.4.1.1 By Product Materials

Coal-ignition ash, metallurgical slag, mine garbage, and agricultural waste are the sources of industrial waste that are produced annually in a gigantic quantity worldwide (Nadir & Sujatha, 2018). Some of them are presently used in the OPC industry, but most of them are disposal stored (Komnitsas & Zaharaki, 2007; Nuruddin et al., 2011). Fly ash, rice husk ash (RHA), granulated blast-furnace slag (GBFS) are examples of this kind of waste. Its properties are the key to be used in the construction industry since it is reasonably cheap to get, extremely robust to chemical attacks and has strong thermal properties (Janotka et al., 2003). It consists mainly of SiO_2 , CaO , MgO and Al_2O_3 .

3.4.1.2 General and Recycled Materials

These materials have less volume than a byproduct. Disposal of these wastes by using will work on decrease the pollution. Wastepaper sludge ash (WPSA), water sludge and construction are examples of these materials.

3.4.1.3 Natural Materials

A large number of researchers revealed that some natural sources could produce raw material for geopolymers such as kaolin, which comes from kaolinite or china clay, metakaolin from calcined kaolin, etc. however, the availability of these natural materials limit their application.

Some experiments uncovered that calcium-based material could deliver the same mechanical strength of the conventional one due to the presence of geopolymeric gel and C-S-H cross-linkage in a single binder. Some researchers have been carried to compare the compressive strength for different types of raw material where they revealed that industrial waste has the most mechanical strength among the others as it is shown in Figure 3-8. However, many parameters should be considered, due to affecting the mechanical strength, such as curing conditions, alkaline type, and concentration, Si/Al ratio, etc. (Suwan, 2016).

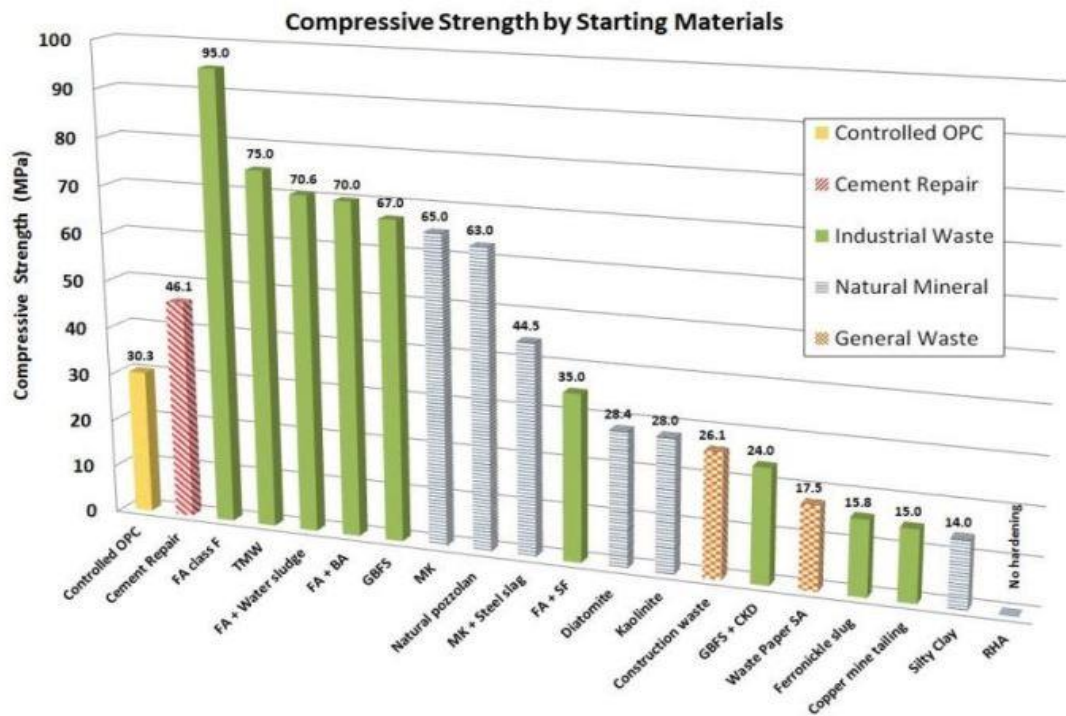

Figure 3-8 Compressive Strength vs Type of Materials (Suwan, 2016)

3.4.1.4 Geopolymer Precursors

Precursors are based mainly on natural minerals but to normalize the chemical composition and engineer the properties, sources of aluminosilicate from wastes are used.

3.4.2 Alkaline activator

It is divided into two kinds in the periodic table of elements, alkaline metals, and alkaline earth metals. Alkaline metals have one electron active in its outer shell while the earth metals have two valence electrons and considered one of the active components in nature (Vol'nov & Petrocelli, 1966). The alkaline metals are more reactive than earth metals and thus more often used as an alkaline activator solution in the geopolymerization process. NaOH/KOH, $\text{Na}_2\text{SiO}_3/\text{K}_2\text{SiO}_3$, and a combination of more than one of them are examples of alkali solutions (Fernández-Jiménez & Palomo, 2005; Panagiotopoulou et al., 2006).

3.4.2.1 Potassium Hydroxide

It has a lower degree of reactive than NaOH, and thus, Na endorses more aluminosilicates than K, but geopolymer based KOH showed higher value of compressive

strength, which measured by using the uniaxial compression strength (UCS) than of Na since the rate of dissolution does not decrease the geopolymerization process.

3.4.2.2 Potassium Silicate

It is soluble silicates, and it is the blend of SiO_2 , H_2O and M_2O (alkali metal, such as Li, K or Na). SiO_2 is the responsible for deciding the modulus of soluble silicates/ M_2O corresponding to this formula ($x\text{SiO}_2 \cdot \text{M}_2\text{O} \cdot z\text{H}_2\text{O}$), where x and z are the amount of polymerization and the donation from water molecules, respectively.

3.4.2.3 Deionized Water

It is declared that using deionized water (pH=7) as a part of the alkaline solution would establish a medium for the dissolution of aluminosilicates, allows moving various ions during the process, achieves the hydrolysis of Si^{+3} and Al^{+3} composites and conducting the polycondensation process of different hydroxyl species (*Petroleum and natural gas industries. Cement and materials for well cementing*, n.d.).

3.5 Design of Geopolymer Mesh

There are several parameters to be considered, and thus the geopolymer proportioning is so intricate. Each one of these factors would affect the properties of the geopolymer in different ways, and therefore each of them has advantages and disadvantages.

3.5.1 Alkaline Activator Concentration

Researchers have shown that the concentration of solute mass has a vital role in the geopolymerization process and its properties (Khalifeh et al., 2015; Saeed Salehi et al., 2017; van Oort et al., 2019) . Analysis has been done on a fly ash-based geopolymer demonstrated that getting a stronger geopolymer with lower porosity is a consequence of an increase in the reaction's rate by increasing the concentration of alkaline (Chindaprasirt et al., 2007). Other investigations showed that the higher intensity the much time geopolymer slurry needs to set where it promotes the existence of disproportionate ions, which restrict the mobility for polymer results in lagging the formation of the polymer. In addition, the level of hydration reaction goes up when the intensity of the alkaline solution raises, leading to an improvement of the properties of microstructure (Fernando et al., 2010). In fact, use of potassium or sodium hydroxide in the mix design results in decrease of modular ratio (i.e. $\text{SiO}_2/\text{K}_2\text{O}$) and cause faster geopolymer

reaction. However, if the used concentration is high, then the product will not be a geopolymer, but an alkali activated based material. Consequently, C-A-S-H gels are produced.

Steins (Steins et al., 2013) showed that the larger the size of an alkali solution (Na^+ - K^+ - Cs^+), the more critical the oligomers and interaction between silicates become and this will induce different behavior according to the ratio Si/M. For instance, gelification phenomena were noticed for lower ratio Si/Al with potassium activator than sodium-based activator solution. By studying the network percolation time through in situ energy-dispersive X-ray diffractometry, it is proven that the geopolymerization rate reduces when the size of alkali cation increases (Rooses et al., 2013). Another study has been conducted to estimate the activation energy of the reaction by Poulesquen et al. 2011. They conducted rheological investigation on sodium and potassium-based geopolymer at different temperatures. Their study revealed that the reaction mechanism is almost the same for various cations though the reaction time is not the same (Poulesquen et al., 2011). All studies confirm that the bigger size cation, the smaller and narrower pore size it has where the combination of pores will be limited due to a reduction in mobility, and that results in forming small pores.

3.5.2 The Modular Ratio ($\text{SiO}_2/\text{K}_2\text{O}$)

The divergence in this proportion has a significant impact on geopolymerization, and thus it has a great influence on the mechanical properties of the geopolymer (Rangan, n.d.). When the geopolymeric slurry contains a high content of silica in solution, the congestion of ionic silica increases. This raise in the saturation of species prompts delaying the partition of geopolymer and the precipitation of species which has large molecular. Consequently, the output will be a hard gel with an improved density. So, the increase in modular ratio will increase the pumping time. This study was done based on fly ash (Sagoe-Crentsil & Weng, 2006; Zuda et al., 2006). Other analyses highlighted the essential rule of this module regarding the rate of crystallization, the kinetic reaction, and the formation of gel, which is favorable to the mechanical strength. This research recommended sticking with this range of 1-2 to get the best performance of activator (Fernández-Jiménez et al., 2005).

3.5.3 Alkaline Activator/Aluminosilicates Source

It is deemed highly crucial factor among the others when we consider the fire resistance and the general properties of the geopolymer (Fernandez et al. 2005). Some experiments were carried on fly ash-based geopolymer advocated the optimum value of this ratio is in range of

0.3-0.45 (Duong & Škvára, 2016; Krizan & Zivanovic, 2002). In high-pressure, high-temperature (HPHT) wells, the high temperature will promote forming a crack through cement sheath, which results in gas migration to surface and then blowout of the well. Contrary, several studies have revealed the high resistance of geopolymer against the high temperature.

3.5.4 M/Al Ratio

The dissolution of aluminum silicates increases and becomes so fast when the pH of the solution increases. The alkaline hydroxide controls the pH of the solution, so it has a vital role in the geopolymerization process. It is proven that the NaOH has an optimum value (Na/Al=0.63) where the geopolymerization rates reach its maximum and higher or lower than this value will decrease the rate (Provis & Rees, 2009). Another study has been performed on metakaolin based geopolymer and by using different concentrations of NaOH. This study indicated that a higher Na/Al would increase mechanical strength and density (Zheng et al., 2010). Another one has been performed to see the effect of this ratio on the amount of percolated cation. Leaching experiments that have been conducted on Na and K metakaolin based geopolymer, demonstrate an increase in the amount of leaching as the ratio of Na/Al grows. In the realm of cementitious materials, use of high concentration NaOH or KOH will yield C-A-S-H gels and the product is called alkali activated based material. However, when low concentration and low amount of KOH or NaOH is used the reaction yields N-A-S-H or K-A-S-H and the product is called geopolymer. C-A-S-H gels are susceptible to CO₂ and H₂S attack while Na (K) -A-S-H gels are stable and do not interact with the corrosive chemicals (Khalifeh, Todorovic, et al., 2016).

3.5.5 Water Content

A study was carried out on different ratios of H₂O showing that the higher water content generates lower reactivity and mechanical strength where geopolymer with this value will need 24 hours to harden and has a low value of mechanical strength (Barbosa & MacKenzie, 2003). Another one has been worked on finding the optimum amount of the water content to reach the best possible value of the rheological properties of geopolymer and its mechanical strength. This ratio of H₂O/Na₂O is uncovered to be around 9-14 (Sugumaran, 2015).

3.5.6 Curing Temperature

Previous efforts have supported the effect of temperature on the mechanical strength of the geopolymer. Rangan 2015., claims that there is a threshold of temperature, beyond which the strength of the sample starts to decrease instead of increasing (Rangan, n.d.). The hydration process reaches its peak at a temperature in the range of 50-80°C. There are two methods for curing by temperature: steam and dry heat. The compressive strength of the sample cured by dry heat is 15% higher than of cured by steam (Duong & Škvára, 2016). However, some other researcher produced geopolymers which can withstand temperatures up to 1000°C. The main uncertainty in published research works and inconsistency in the results is originated from the studied mix designs and not respecting the C-A-S-H and Na-A-S-H concepts.

3.5.7 Curing Time

Considerably, it is shown from all studies that curing time affects the progress of geopolymer strength. It controls the ultimate compressive strength of the binder. Within the first few hours of reaction, the slurry thickens fast and gains around 85% of its compressive strength (Khale & Chaudhary, 2007). Deliberately, the growth in the strength will go as time goes up because of alkaline saturation and product densification (Duong & Škvára, 2016). Khalifeh et al. (2016) showed that the mechanical properties of their rock-based geopolymers increases up to one year (Khalifeh, Todorovic, et al., 2016)

Both of curing temperature and duration have a massive flexible scale to achieve the desired mechanical strength of the geopolymer. However, there are many factors that should be considered to get the optimum condition for curing, such as raw material, alkali solution, water content, age, etc. (Chindaprasirt et al., 2007). The structural water will be affected by the curing condition as it could be released so fast in the condition of loge period of curing or high-temperature results in shrinkage of the geopolymer sample (Bakharev, 2005).

3.5.8 Silica/Alumina Ratio

It has a substantial effect on the degree of crystallinity and reaction (Xu & van Deventer, 2003). Studies divided this ratio into three main categories; each one of them has its features. When $Si/Al = 1$, it is called sialate, polysialate-siloxo when Si/Al is equal to 2, while polysialate-diloxo for Si/Al is equal to 3. The last two provided a geopolymer with good strength, but polysialate-diloxo is formed faster than diloxo and thus has a low compressive strength comparing to the compressive strength of diloxo. The nature of raw material will affect

the optimum ratio of this module. However, the range of 2-3 could be considered a good choice, according to many studies (Andini et al., 2008; Duxson et al., 2006). As declared before, this ratio should be more than 1 regarding the Loewenstein avoidance rule in aluminosilicates. The product of the study performed on the structure of a geopolymer revealed that a supplement of silica reduces the formation of crystalline phases (White et al., 2011). Many studies showed the effect of Si/Al on the geopolymerization process and its structure. An increase in this ratio will result in a growth of oligomers size leading to a reduction in the reactivity and thus a shrinking of the pore size and rising in the mechanical strength. According to some researchers, adjusting the molar ratio of Si/Al has a vital function in controlling the setting time. They claimed that escalating in the amount of Al_2O_3 will speed up the setting time. Contrary to growth in SiO_2 , which leads to postponing the setting time. This surging in the content of SiO_2 will produce microstructures with low porosity results in the development of mechanical strength of the geopolymer binder, though. Other experiments have been performed and declared that there is an optimal ratio of Si/Al (3.2-3.7) and any movement from this range will hasten the thickening time. Figure 3-9 The Effect of Ratio of SiO_2/Al_2O_3 Figure 3-9 illustrates the effect of the ratio of SiO_2/Al_2O_3 on the setting and the compressive strength of the geopolymer slurry.

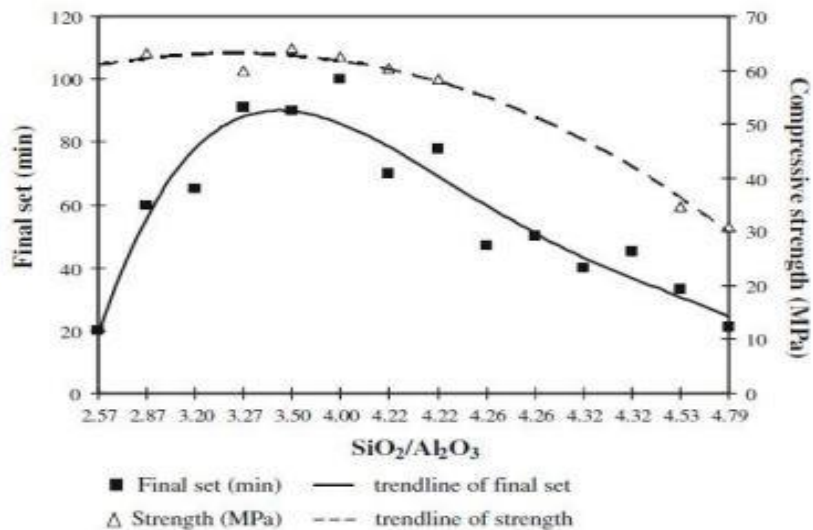

Figure 3-9 The Effect of Ratio of SiO_2/Al_2O_3 (Andini et al., 2008; Duxson et al., 2006)

3.6 Characterization of Geopolymer Properties

There are many advantages of a geopolymer that prompt operators to use it in industries. A large number of studies carried on the geopolymer to highlight its properties, and since OPC is the most used material overworld, they compared geopolymer to OPC (Khalifeh, Hodne, et al., 2016; Nasvi et al., 2014; Paiva et al., 2018). Geopolymer has high strength, high resistance to chemical, and low permeability. Moreover, it has good ductility, durability, more resistance at HPHT conditions, and less contamination with OBM (Khalifeh et al., 2018; S. Salehi et al., 2016).

3.6.1 Setting Time

It should be assured that the pump which will be used in the field is capable of pumping the geopolymeric slurry in a certain period of time to the desired depth and so the setting time is a crucial factor of geopolymer. It is a significant property of fresh mixture where it limits the possibility of geopolymer to be used in situ. ASTM WK is used to measure the setting time of the slurry, and it is specified that initial and final setting times are 24 kPa and 430 kPa of resistance, respectively (Zubrod, 2013). The geopolymer thickening time is regulated by all forms of alkaline activators, activator concentration, liquid to solid ratio and curing temperatures.

3.6.2 Flowability

The limitation of using a rheometer in the field was the key to find other methods to evaluate the workability of the sample. One of the studies suggested using the mini-slump cone, where the spread of the slurry is related directly to its flowability (Collins & Sanjayan, 2001; Favier et al., 2013).

2.6.3 Mechanical Properties

It contains compressive strength, tensile strength, flexural strength, and bond strength. Its deputy and ease promote the compressive strength to evaluate the binder (Komnitsas & Zaharaki, 2007). Many studies used ASTM C109 to assess the compressive strength (Karakoç et al., 2014; Nematollahi et al., 2015). While a tensile strength is used to identify the strain hardening, the pullout test is applied to evaluate the bond strength. There are many parameters that will affect the strength of a geopolymer, such as formulation, raw materials, cure

parameters, and potential filler. Geopolymer has bending strength without reinforcement. It is about < 5 MPa while compressive strength could reach to 100 MPa.

3.6.4 Shrinkage

It is the process of reducing in volume with time. Water content in the structure affects the pores and the porosity between them. A geopolymer of the dense structure has low water absorption, so it shows little shrinkage and low creep. In geopolymerization, the water may be evaporated if there is lack of humidity. In cement hydration, water is consumed, and the formed minerals have lower volume compared to volume of water and cement at initial condition before reaction happens. It is found that temperature promotes the early strength and thus prompts the presence of large pores (Lizcano et al., 2011). However, the use of additional water will significantly increase the volume change and cause high intensity of shrinkage.

3.6.5 Durability

The chloride, sulfate, acid, and thermal resistances are features of durability. The microstructure and the movement of ions control this property of geopolymer. Alkaline activator will affect the shape and stability and thus the durability of the sample. Some studies showed the effect of acids on the geopolymeric slurry where the bond Si-O-Al is broken, leading to form Si-OH and Al-OH. This has been rejected by some other researchers. The main reason could be deviation in producing N-A-S-H and then making C-A-S-H gels. It means an increase in the amount of acid in the solution that results in mass loss. A lot of tests demonstrated the good fire resistance of geopolymer even if the temperature is rapidly changed and less deterioration when it is attacked by an acid solution. Using KOH as an activator instead reduces the efflorescence of a geopolymer (Fernández-Jiménez & Palomo, 2009; Rashad & Zeedan, 2011).

3.6.6 Acid Resistance

Most studies have been performed on fly ash-based geopolymers to see the limitation of geopolymer when it reacts with corrosive mediums. The results are varied from high resistance to acidic attack to partial degradation of the structures. One article that has been carried on the reaction of a metakaolin based potassium geopolymer with HCl with different concentrations and scenarios showed a good reputation of geopolymer towards this acid. Khalifeh et al. (2016) studied the durability of their rock-based geopolymers at downhole

conditions (100°C and elevated pressure) and in presence of H₂S, brine, and crude oil. Their result showed that due to ultra-low permeability of their geopolymers and formation of K-A-S-H gels, the geopolymers could survive the condition up to 1 year.

3.6.7 Thermal Resistance

Studies showed that the thermal resistance of a geopolymer depends on the cation selection, cure parameters, and the filler. Geopolymer has good thermal stability at the proper cured condition. It keeps its amorphous structure at high temperature (losing water at 80-200 °C). The crystalline phase starts to form over 800 °C and the cation selected is the responsibility of the nature of the crystalline where nepheline is formed for sodium-based geopolymers during leucite for potassium geopolymers and pollucite in the presence of cesium. It finally melts around 1100~1200 °C.

3.6.8 Porosity

Many studies have been carried on the geopolymer to figure out its porosity. They claim that the porosity of a geopolymer could be one of three, macroporous, mesoporous or microporous. In order to define the porosity of geopolymers, a comprehensive study is performed by using nitrogen and water adsorption, small-angle X-ray and neutron diffusion, mercury intrusion, ions diffusometry, and TEM. This study defined that the porosity of a geopolymer varies from macroporous to mesoporous based on the amount of water in the structure (Struble et al., 2013; Weil et al., 2009). In general, most researchers believe that its porosity is mesoporous, where it has a total volume fraction of 0.4.

4. Retarding Admixtures for Geopolymer – State of the Art

All researches have shown the potential of a geopolymer to be used instead of cement; however, it is not used as a complete alternative of OPC in the oil field until now due to its workability. The geopolymeric slurry is set so quickly at high temperatures. Many researchers have studied the flow behavior and mechanical properties of the geopolymer to figure out how to delay the thickening time of the geopolymeric slurry and thus improve its workability. Some experiments revealed that the distribution of geopolymer particles regulates the behavior of the flow and the ratio of water to raw material controls the mechanical strength (Chandra & Björnström, 2002). Another study analyzed the mechanism of mixing water with the geopolymer blender and demonstrated that the rate of hydration could be altered by using some chemical additives (Swenson & Thorvaldson, n.d.). One of the studies has used a retarding admixture to delay the setting time of the paste at high temperature, which improves the pumpability of the slurry without any effect on its mechanical properties (Mindess, 2008; Park et al., 1999). Processes of set retardation have been analyzed to show the act of retarder with the slurry. The study showed that the absorption of retarder by the paste mixture could create a film around the compound of the mix. This film would work on slowing the reaction of the mixture with water, and its thickness will determine how long the rate of hydration could be delayed. The film will break down, and the hydration process will proceed after a while (Supriadi et al., 2016). Many factors are affecting the reaction of retarding admixtures, such as admixture dosage, curing condition, and time of addition to the mix. Some admixtures will act as accelerators when used in large amounts, and some of them will result in preventing the set of the geopolymer slurry. So, it is critical to use the optimum dose of the retarder admixture (Alshamsi et al., 1997).

This chapter aims to provide an overview of the chemical admixtures that are used as retarders and their reaction mode. It will highlight the types of retarders and their effect on the mechanical properties of the geopolymeric slurry beside the setting time.

4.1 Reaction Mechanism of The Set Retarding Admixture

When considering OPC, chemical additives can decrease the amount of penetrated water to the geopolymeric slurry particles and delay the hydration rate. Consequently, the reaction speed between the blender and water will decelerate, and thus the thickening time will prolong. However, the geopolymerization is different from cement hydration. In

geopolymerization, few percentages of water are consumed in the reaction and water acts only as medium to transport ions. Several studies have been conducted on different types of retarder (for geopolymers) and revealed that a kind of retarding admixture could act in different mechanisms of interaction (Mahmoudkhani et al., 2008). Considering the concepts concerning cement retardation, perhaps one could create analogy between geopolymer and cement retardation mechanisms. There might be four types of interaction between the retarder and the geopolymeric slurry if the retardation mechanisms of cement could be used as starting point.

4.1.1 Adsorption

Particles of retarding admixture are adsorbed on the surface of the monomers or oligomers, which will delay the reaction between the hardener and precursors, reducing the contact of hardener and precursors. This may prolong the pumping time and postpone the setting time.

4.1.2 Precipitation

The monomers or oligomers react with the retarder and create a precipitate, which leads to a decrease in the permeability and thus reduces the amount of water, which goes into the geopolymer particles. This may prolong the pumping time and postpone the setting time.

4.1.3 Complexation

Accumulation of complexes in the solution inhibits Al, Si, and OH^- to be triggered in the aqueous solution, which leads to delay the formation of N-A-S-H gels and thus, prolonging the pumping time and postpone the setting time.

4.1.4 Nucleation

Adsorption of retarders on the surface of the geopolymer molecules leads to delay in the growth of the 3D network of geopolymers, which results in retarding the final stage of geopolymerization. This may postpone the setting time but not prolonging the pumping time.

4.2 Water Reducer, Retarders and Superplasticizers

Water content is an important factor in the geopolymer mixture. The ratio of water to solid defines the quality of the paste and its strength. Reducing in this ratio leads to an increase in the density of the paste, which results in high compressive strength and high slurry quality

(“Design of concrete mixtures for durability,” 2017). Water reducers, retarders and superplasticizers are admixtures that are used to decrease the amount of water in the mixture and/or delay the thickening time with retaining the high-quality properties of the geopolymeric slurry (“Improved Air-Entraining Admixtures for Concrete,” 1968).

4.2.1 Water Reducing Admixture (WRA)

WRA works on reducing the water content of the mixture by maintaining a certain level of consistency. WRA could work as a retarder or an accelerator, based on its dosage. WRA with retarding effect lengthens the setting time of the paste and increases its strength; examples of WRA are Lignosulphonates and hydroxycarboxylic.

4.2.2 Superplasticizers (SP)

It is known as a high range water reducer and retarding admixtures. It is used to reduce the water content by 12-30 % of the paste, which results in improving the workability of the geopolymer paste. Superplasticizers are soluble macromolecules, and the adsorption is the primary mechanism of their reactions with the mixture (Banfill, 1998). There are four kinds of them: melamine-based sulfonate, naphthalene-based sulfonate, modified lignosulphonates, and a combination of HRWR and accelerating admixture (Aitcin, n.d.; “Chemical Admixtures for Concrete,” 1989). Adsorption of superplasticizer on the surface of the geopolymeric slurry can lead to increase the workability and lengthen the setting time of the geopolymerization process. The adsorption rate of superplasticizer depends on the chemical and composition of the slurry and, consequently, defines how long the workability could improve (Kaeding, 2018; Ramachandran, 1996). Several experiments have been conducted on different types of SPs. It is performed that the mechanism of SPs reaction with the geopolymeric slurry depends on the raw material, type of alkali solution, type and dose of SPs, and the pH of the solution. It is investigated that using any kind of superplasticizers can result in decreasing the strength of the slurry. Some of them can lead to an increase in workability, but others do not have any effect. It is reported that modified polycarboxylates is the highly successful type of superplasticizer with fly ash-based geopolymer and NaOH with Na_2SiO_3 as a solution activator, while naphthalene is the most useful kind when it is used with slag and the same activators (Nematollahi & Sanjayan, 2014).

4.2.3 Retarding Admixtures

They have two categories of retarders; the main difference between them is the water reducer properties. Admixture slows the rate of hydration by decreasing the initial setting time of the paste. Retarders can produce from organic and inorganic materials. Ca, Na, NH₄, hydroxycarboxylic acids, carbohydrates and salts of lignosulphonate acids are examples of organic retarders, while inorganic one consists of phosphate, magnesium salts, borates, fluorates, oxides of Pb, and oxides of Zn. Lignosulfonates and hydroxycarboxylic acids are regarded as a retarding and water reducer admixture, while phosphates are one of the retarding admixtures without the properties of water reducing (Neville, 1995; Ramachandran, 1996).

4.3 The Nature of Retarders

There are two classifications of retarders: one may act on pumping and the other impacts the setting and hardening. Each of them has a different function and mechanism. The hardening one works on reducing the development rate of the early strength of the geopolymer paste, and thus the heat evolution rate will decrease, which leads to dropping in the max temperature and preventing the thermal crack (Brearley, 1990) while the set retarding admixture rises the transition time of the mixture to transform from the liquid phase to the solid phase, which results in compensating the acceleration effect of high temperature and increasing the allowable time for transportation, mixing and pumping and thereby avoiding the setting of the geopolymer during the circulation job (Wedding et al., 1981). There are two ways to measure the pumping time and the hardening, direct and indirect. The hardening development is computed directly by measuring the compressive strength, while a penetration needle, such as, a Vicat machine is used to measure the mechanical rigidity that defines the thickening time of the paste. Indirectly, both pumping and hardening are estimated by measuring the heat evolution or via the measurements of the excess generated temperature from the chemical reaction between the geopolymer binder and water. The lagging in the hydration process leads to either produce the heat at a late stage of the reaction, which results in prolonging the setting time or produce the heat at a slow rate and thus delaying of the hardening (EFCA). Figure 4-1 shows the difference in the rate of heat evolution, which produced due to the use of the pumping and hardening retarders. It is proven that the heat evolution produced from the setting retarder is more than of the hardening one.

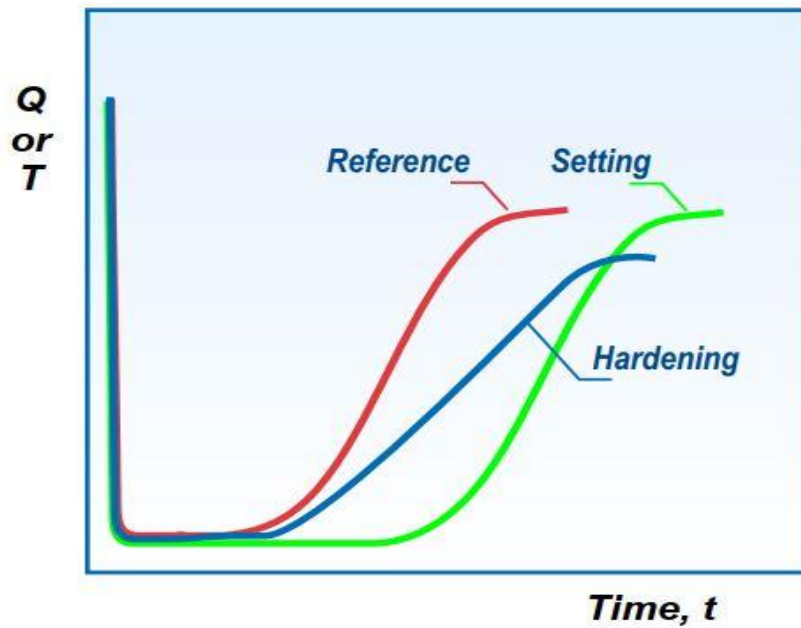

Figure 4-1 The Setting and Hardening Effect on The Heat Evolution

There are two main kinds of the retarding admixture, organic and inorganic-based chemicals as it is presented by Table 4-1 (Gunter, 2016).

Table 4-1 The Types of Retarding Admixture

Organic chemicals	Inorganic chemicals
Unprocessed Na, Ca or NH ₄ salts of Lignosulphonates acids	Phosphates
Hydroxycarboxylic acid and their salt	Borates & fluorates
Phosphonates	Salts of Cu, As, Mg and Sb
Carbohydrates like Sugars	K ₂ HPO ₄ & KH ₂ PO ₄ & Al ₂ O ₃
	Oxides of Zn and Pb phosphates

4.3.1 Lignosulphonates

The admixture of retarders mainly depends on materials having lignosulfonate acids and their salts. Lignosulfonate is the deposit of chemical paste grinders, and it forms around 90% of the liquid waste-producing from the industry of pulp mills. Some studies have been carried on industrial lignin. It showed that there are approximately 50 million tons of lignosulfonate and alkali lignin delivered every year, and just 10% of them are used (Dawy et al., 1998). There

are two groups of lignosulphonates, hydrophobic one, which contains a carbon chain, and the second group is hydrophilic, which contains sulphonic, alcoholic hydroxyl, and phenylic hydroxyl (Telysheva et al., 2001).

One study has been performed on three types of lignosulphonate, lignosulfonate, sodium lignosulfonate, and calcium lignosulfonate to show the effect of using retarders-based lignosulphonate on the properties of the geopolymer. The experiment showed that the viscosity of geopolymer paste decreases and thus, the fluidity increases by raising the dosage of the used lignosulfonate. The normal one showed less viscosity among the others.

The effect of lignosulphonates on the setting time of the geopolymer has been analyzed by comparing the use of different types of lignosulfonates with the geopolymer paste without any retarder. The experiment revealed that the thickening time is prolonged by utilizing lignosulphonates as a retarder, and it is extended more and more by increasing its dose. The normal lignosulphonate has the highest effect, followed by sodium-based lignosulphonates. On the other hand, the calcium-based lignosulphonate has the highest impact on the compressive strength. The research performed that the compressive strength of the paste is improved by growing the curing time and the dosage of the lignosulfonates-based retarder.

4.3.2 Sugars

Saccharides consist mainly of carbohydrates with groups of hydroxyls. Sugars are classified into two groups: reducing and non-reducing. The reducing sugars produce some ketone or aldehyde in the basic solutions and thus has a moderate effect, while the non-reducing is either very efficient or inefficient retarders, based on the chemical structure of them. Table 4-2 displays examples of non-reducing and reducing retarders (Harr, 1991; Hewlett, 1998)

Table 4-2 Reducing and Non-reducing Sugar

Reducing Sugar	Non-Reducing Sugar
Glucose	Sucrose (Glucose-Fructose)
Fructose	Trehalose (Two Components of Glucose)
Lactose (Milk Sugar)	Raffinose
Maltose (Malt Sugar)	

Sucrose is known as an extremely effective retarder, but its dose restricts its usage. Figure 4-2 expressions the chemical structure of sucrose, where glucose and fructose are

combined together to form sucrose. Raffinose is a very efficient retarder, while Trehalose is an inefficient one (Collepari, 1996).

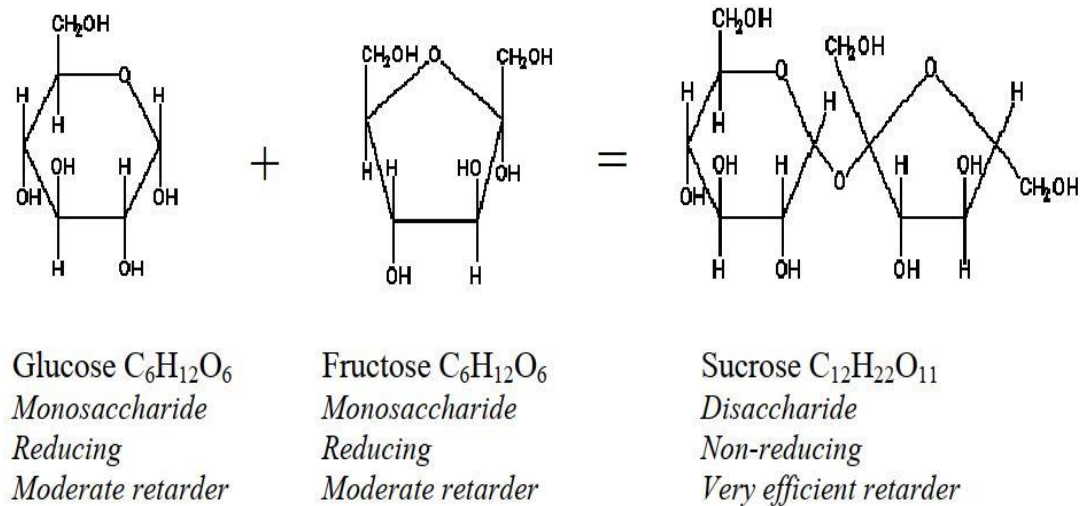

Figure 4-2 The Chemical Structure of Sucrose (Collepari, 1996)

It is investigated that using sucrose will lengthen the setting time and improve the mechanical strength of the paste. In different curing conditions, adding 1% of sucrose to a mixture of fly ash-based geopolymer enhances the strength of the paste and increases the setting time of it (Shaikh & Vimonsatit, 2014). Some studies are carried on the mechanism of sucrose reaction with a fly ash-based geopolymer and concluded that the chemical bond (HO-C-C=O) is converted from sucrose into acid complexes. The particles of binder can adsorb the acid complexes, and sucrose forms insoluble metal-organic complexes by combination with Ca, Al, and Fe in the mixture. The insoluble metal can cover the surface of the paste, which results in slowing down the geopolymerization process and thus prolonging the setting time (BRUERE, 1966; Ramachandran & Feldman, 1996)

4.3.3 Hydroxycarboxylic Acids and Salts

They are a chemical group of several members, which are manufactured in large volumes. Hydroxy acids are polycarboxylic acids, which contain at least two groups of carboxylic, such as, citric acid, glycolic acid, oxalic acid, and tartaric acid (Mizuno & Shioiri, 2010). It is investigated that the chemical properties of hydroxycarboxylic are linked to those of sugar, and thus some of them have the same retarding mechanism of sugar (Collepari, 1996;

Ramachandran, 1996). A study has been carried out on the reaction of hydroxycarboxylic acids with the paste. It revealed that a complex of salicylic acids with Al results in delaying the hydration of the paste and thus prolong the setting (DIAMOND, 1972).

4.3.4 Inorganic retarders

Most inorganic retarders work on coating the binder particles by producing an insoluble hydroxide in the solution, which results in delay in the hydration process. It is studied that some of them can delay the setting time by producing a complex with the geopolymeric slurry, such as oxides of Zn and others like Pb delay the process by precipitation (Alshamsi et al., 1997; Banfill, 1998; Thomas et al., 1981).

4.3.4.1 Phosphates

Sodium phosphate is utilized in some experiments to retard the setting time of alkaline activated material. It is concluded from the XRD experiment that sodium phosphate forms a new phase at the early stage of reaction with AARS, which results in creating a membrane cover on the surface of AARS. The new phase can retard the setting time of the geopolymeric slurry reduce the heat evolution (Gong & Yang, 2000).

4.3.4.2 Potassium Dihydrogen Phosphate

KH_2PO_4 is the molecular formula of monopotassium phosphate. It consists of inorganic phosphate and potassium salt.

4.3.4.3 Sodium Dihydrogen Phosphate Dihydrate ($\text{NaH}_2\text{PO}_4 \cdot 2\text{H}_2\text{O}$)

Sodium phosphate admixture is a water-soluble white crystalline solid (Collepari, 1996). It is investigated that sodium phosphate lengthens the dormant period, which results in slowing down the rate of hydration and increasing the setting time (Monteiro et al., 1985). Another study has been conducted on different kinds of sodium phosphates. It is found that sodium phosphate has more effect on lengthening the setting time of the geopolymeric slurry more than sodium hexametaphosphate (Ramachandran & Lowery, 1992).

4.3.4.4 Phosphonates

A large number of researchers proved that salts and acids of phosphonates are an efficient retarder for inorganic polymer materials as they form complexes with cation during the mixing with alkali solution (Collepari, 1996).

4.3.4.5 Borax ($\text{Na}_2\text{B}_4\text{O}_7 \cdot 10\text{H}_2\text{O}$)

It is known as sodium borate and is a salt of boric acid. A large number of studies has been conducted on utilizing the borax with a fly ash-based geopolymer. It revealed that the

addition of borax could lengthen the setting time and gradually improve the compressive strength of the geopolymer mortar (Antoni et al., 2016). Another study has applied on class F fly ash-based geopolymer with using anhydrous borax. It is concluded that the retarding effect of borax depends on its dose, curing temperature and intensity of alkali solution. The effect of borax can work up to 75 °C with and hinders at 90 °C. It is investigated that the retarding effect of borax comes from producing BO_4 , which works on inhibiting the polymerization process and thus increasing the setting time (Liu et al., 2017).

4.3.4.6 Barium chloride dehydrate ($\text{BaCl}_2 \cdot 2\text{H}_2\text{O}$)

It is a hydrate barium salt and inorganic chloride. Based on several experiments, there is an optimum value of barium chloride dehydrate to causes increasing the workability and the setting time of the geopolymer mortar, over this dose can result in segregation. It is important to mention that barium chloride dehydrate has no effect on the strength of the geopolymeric slurry (Prinsse et al., 2019).

5. Methodology

In this chapter, the materials used, and their dosage are labelled. In particular, the procedures of the mixtures, the equipment and devices used during the experiments. It also includes the tests and their devices, which are utilized to analyze the mechanical properties of the samples. The analytic method, which is applied to define the value of these mechanical properties, are described.

5.1 Materials

It is confidential as it is provided by Stavanger University and various companies that showed interest in this project. Two main components are the base of the geopolymer, solid-phase (known as geopolymeric precursors) and liquid phase (known as hardener). The solid phase comes from source materials which should be abundant in silicon and aluminum. In this thesis, a special rock was used to produce rock-based geopolymers. The chemical composition of the rock was normalized by introducing reactive aluminosilicate materials to produce the geopolymeric precursors. The hardener (alkaline liquid), which is responsible for the polymerization is mainly silicate solutions. Potassium silicates, potassium hydroxide and ionized water, generate the hardener required to activate aluminosilicates.

The recipe of the precursor and the hardener, which are used for preparing the first sample (BS1) are exposed in Table 5-1, while Table 5-2 shows the chemistry of the precursor of BS1. It is regarded as the base reference sample that is used to highlight the effect of the retarders on the pumping time of the sample. This recipe is the same for the first five samples (S1, S2, S3, S4, and S5). The total slurry mix design for the five samples is illustrated below in Table 5-3, where it shows the retarders which are used for each one of specimens. The same recipe of BS1 is used over the five samples besides the chemical, which are used for each sample to see its effect compared to the BS1 (without any additives).

Table 5-1 The Compositions of The Base Reference Sample (BS1)

Elements	Precursors	Hardeners	The modular ratio of hardener (SiO ₂ /K ₂ O)
BS1	700 g	368 g	2.35

Table 5-2 The Chemistry of Precursor for BS1

Compositions	Precursors of BS1
SiO ₂	62.7142857
Al ₂ O ₃	10.2617143
Fe ₂ O ₃	0.5857143
CaO	13.736
MgO	7.3657143
Na ₂ O	1.8131429
K ₂ O	1.6565714
TiO ₂	1.0491429
MnO	0.0102857
SrO	0.0102857
BaO	0.0051429
S ²⁻	0.5571429
LOI	0.2348571

Table 5-3 The Chemicals and the Weight of Different Retarding Admixtures

Specimens	S1	S2	S3	S4	S5
Retarding admixture	Chemical R	Chemical A	Chemical K	Chemical K	Chemical H
Weight gram	5.5	3.5	3.5	7	3.5

Another recipe is used as a base with different weights of precursors and hardeners. Table 5-4 and Table 5-5 illustrate the recipe of the second base sample (BS2) that is used as a reference for evaluating the effect of various retarding admixtures on the geopolymer slurry. Some retarding admixtures are used with the same recipe of the second reference sample and tested to see its effect on the reference trend of BS2. Table 5-6 shows the chemicals and the weights of the used retendering admixtures, which are used with BS2.

Table 5-4 The Recipe of The Second Base Sample (BS2)

Precursors	Hardener	The modular ratio of hardener (SiO ₂ /K ₂ O)
------------	----------	--

700 g	395 g	2.56
-------	-------	------

Table 5-5 The Chemistry of The Precursor of BS2

Compositions	Precursors of BS2
SiO ₂	61.1357143
Al ₂ O ₃	10.5028571
Fe ₂ O ₃	0.5792857
CaO	14.6028571
MgO	7.8428571
Na ₂ O	1.7928571
K ₂ O	1.5978571
TiO ₂	1.1171429
MnO	0.01
SrO	0.01
BaO	0.005
S ²⁻	0.5942857
LOI	0.2092857

Table 5-6 The Type and Weight of The Retarding Admixture

Samples	Chemical H	Chemical S	Chemical L	Chemical N
S6	3.5 g	0	0	0
S7	3.5 g	30 g	0	0
S8	5.25 g	30 g	0	0
S9	5.25 g	0	0	0
S10	0	0	3.5 g	0
S11	0	0	0	3.5 g

Some tests are performed to see the effect of modular ratio on the pumping time of the geopolymeric slurry. Different weights of hardeners are used to evaluate the relationship between the modular ratio and the pumping time of the geopolymer mortar. Table 5-7 displays some samples with different modular ratios, which are used during this study.

Table 5-7 The Recipe of A number of Samples with Different Modular Ratio

Samples	Precursors	Hardener	The modular ratio of hardener (SiO ₂ /K ₂ O)
S12	700 g	420 g	2.33
S13	700 g	398 g	2.4
S14	700 g	407 g	2.42
S15	700 g	391 g	2.65
S16	700 g	375 g	4.14
S7	700 g	395 g	2.56

Other experiments are applied to find out the effect of mixing design. Some of the retarder admixtures are mixed directly with the hardener; others are mixed first with one element of the hardener before adding them to the remaining components of the hardener.

BS1* has the same recipe of BS1 but with different mixing design, where a component of solid phase is mixed first with the hardener before adding the other ingredients of precursor to the mixture. S5* with the same recipe of S5, but the retarder is mixed first with one component of the liquid phase and then added to the left-over components of the hardener. There is another test that is performed to investigate the effect of chemical W and chemical O on the pumping time of the geopolymer paste. S11* has the same recipe of S11 except that it uses chemical W instead of chemical O in the recipe of the hardener. Table 5-8 illuminates the recipes of both S11 and S11*.

Table 5-8 The Recipe of Specimen S11*

Composition	Precursors	Hardener	The modular ratio of hardener (SiO ₂ /K ₂ O)	Chemical W	Chemical O
S11	700 g	395 g	2.56	-	40 g
S11*	700 g	395 g	2.56	40 g	-

5.2 Equipment

There are a large number of tools that are used during the preparation of the geopolymer. Each of them has its function and procedures to use in a good way.

5.2.1 Mettler Toledo Scale

It is used to measure the weight of the component of the mixture. Its accuracy is about ± 0.01 g. Figure 5-1 shows the scale, which is used during the project.



Figure 5-1 Mettler Toledo Scale

5.2.2 OFITE Model Commercial Blender

It is used to prepare the liquid phase and mix it with the solid phase to prepare the slurry according to API procedures. The constant speed blender has a high rotating speed, which results in a high-level of mixing energy. However, the high energy of mixing and sharp blades could lead to damage to the polymer chain. According to the study, which performed to investigate the effect of mixing on the polymer chains, the polymers should be mixed in two stages. The sample is mixed with high energy in the first stage to avoid the formation of fisheyes, which is developed due to a lack of appropriate wetting—following by mixing at a low speed, which works on protecting the polymer chains from destruction (Aghamir-Baha, n.d.). Figure 5-2 displays the components and the control panel of the mixing.



Figure 5-2 OFITE Model Commercial Blender

5.2.3 Hamilton Beach Mud Mixer

It is used as a non-API mixer. It does not have sharp blades and has quite less speed than the previous one. It is utilized for mixing the alkali solution and additive before adding the solid phase. Figure 5-3 illustrates the non-API mixer, which is used to prepare the liquid phase during the project. Figure 5-4 displays the difference between the blades of API mixer and non-API mixer.



Figure 5-3 Hamilton Beach Mud Mixer



Figure 5-4 The Shape of The Mixer and Commercial Blender Respectively from Left to Right

5.2.4 Molds

It is a cylindrical plastic shape used to keep the specimens for curing. It prevents moisture absorption, and it is easy to get out of the samples. Figure 5-5 shows the shape and dimensions of the plastic mold.

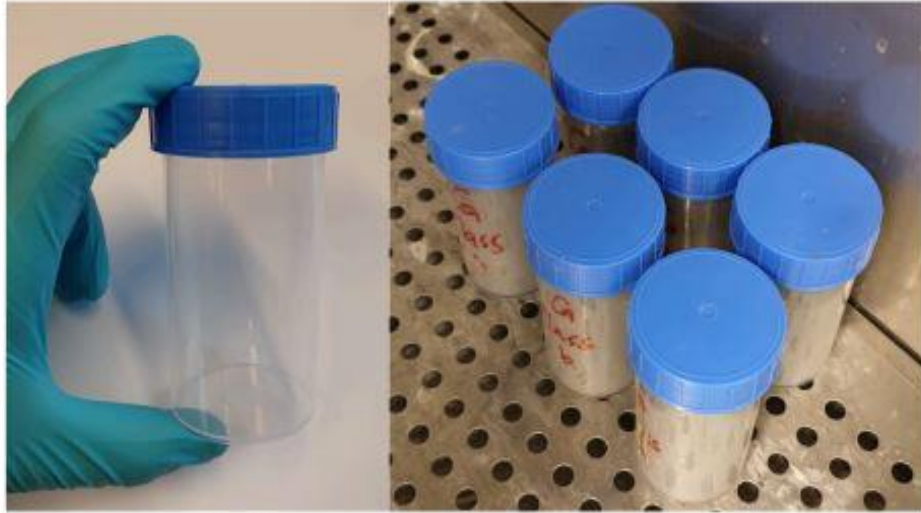

Figure 5-5 Plastic Mold

5.2.5 Atmospheric Consistometer

It works according to API Spec 10A/10B2 standards. There are two main functions of this apparatus. Conditioning of the slurry is the first one, which prepares the paste for some measurements, such as, viscosity, rheological properties, and compressive strength using UCA and UCS. The second task is to measure the consistency, which refers to pumpability and thus setting time. LabVIEW2018 is a software, which is installed on a computer and connected to this consistometer. The thickening time is estimated through this software. Figure 5-6 illustrates the components of ATM-consistometer.



Figure 5-6 Atmospheric Consistometer

5.2.6 Cutting Machine

It is a device, which is used to prepare the demolded samples for the UCS test (crushing test). It is performed to flatten the sample from both sides and thus assuring that a force is distributed along the surface area of the sample during the crushing test. Figure 5-7 shows the cutting machine, which is used to prepare the geopolymer sample for mechanical test.



Figure 5-7 Cutting Machine with Diamond Blades

5.2.7 Hydraulic Press Machine

A Toni Technik-H device with a loading rate of 72 KN/min and a TestXpert v 7.11 software is manipulated to execute the uniaxial compressive strength (UCS) test. Throughout the test, the reported data is used to measure the mechanical properties such as compressive strength and Young's sample modulus. A Zwick/Z020 mechanical testing machine with a loading rate of 50 KN/min and a TestXpert v3.2 software is used to measure the tensile strength.

5.2.8 UCA

An ultrasonic cement analyzer (UCA) as it is shown in Figure 5-8 is a non-destructive test and is applied to estimate the compressive strength through measuring the velocity of an ultrasonic signal under pressure and temperature conditions. The sonic strength is correlated to the transit time. An empirical relationship between the compressive strength and the transit time is used, and then the collected data is sent to a computer to highlight the results (Khalifeh et al., 2014). This method has pros and cons. Its benefits are non-destructive, realistic (simulate a downhole condition), and accurate. Establishing the desired temperature and pressure of downhole condition through an internal oven is integrated with UCA, and A compressor is connected with it. Its drawback is that the tri-axial loading and the shear strength are not considered in this test.



Figure 5-8 Ultrasonic Cement Analyzer

5.3 Mixing Procedures

There are many different ways to mix the solid and liquid phases. In this project, the following steps are applied to prepare the geopolymer paste:

1. Preparing each element of the slurry according to its dosage
2. Mixing the components of solid-phase at dry conditions
3. Mixing elements of the hardener for a few seconds by using the mud mixer
4. Pouring the liquid in the mixer cup of the commercial blender
5. Adding the additives to liquid and mixing them at 4000 RPM for 15 seconds
6. Turning the commercial blender on an automatic position. So, it works for 50 sec, 15 sec at low speed 4000 RPM and 35 sec at high speed 12000 RPM according to API RP 10B-2 standards.
7. Adding the solid to the liquid during 15 secs and then the mixing process is continued for the remaining 35 seconds (*Petroleum and natural gas industries. Cement and materials for well cementing*, n.d.).

It is proven by the different experiment that premixing the liquid together before adding the solid results in improving the workability of the mixture and enhancing the sample strength (Nuruddin et al., 2011; Rangan, n.d.).

5.4 Conditioning of the slurry

It is a simulation for the conditions which the paste will challenge when applied in field applications. The OFITE model 60 atm consistometer is used to create a simulation that the geopolymer will encounter during pumping inside the wellbore and taking its place around the casing. It is designed for low-temperature applications and provides a proper homogenous mixture, which has benefits for the conditioning process. According to API Spec 10A/10B2 standards, the techniques of the conditioning are:

1. Putting a paddle into the container, where it contains a hole at its bottom. This hole is used to secure the paddle at the center.
2. Pouring the slurry into the container up to a marker inside the container (the highest allowable point into the container)
3. A lid is put on the container where the top point of the paddle goes into the torque shaft of the lid. It is secured by rotating the lid until its locking pin is inserted into the pin slot of the container.
4. Putting the container inside a bath (it is made of stainless steel) and locking in place

by using pins and slots. The mineral oil transfers the heat to the slurry container when the temperature is heated up and holds the set temperature.

5. Switching on the main, motor and temperature buttons.
6. Further, setting the temperature on 25 °C and then the software will start recording. The process of recording is performed by using sensors. The lid contains a cord sensor pin on its side, which is connected to a torque sensor. The torque sensor is linked to the software through cables and cord.
7. Once the consistometer is turned on, the slurry cup rotates at a constant speed of 150 RPM.
8. Every 5 mins, ramping up the temperature 5 degrees until reaching the desired temperature.
9. The slurry cup is removed after reaching the determined time of the conditioning, and the slurry is poured into the plastic mold. A small amount of the deionized water is poured on top of the slurry to prevent dehydration of the sample during curing.
10. The molds are left at room's temperature or inside an oven. It depends on the curing condition (Pressure, Temperature and Time).

5.5 Mechanical Characteristics

It is essential to simulate the forces, which will affect the geopolymer in well cementation process to assure that the prepared sample can be used at these conditions. The geopolymer should be able to support the casing and tolerate the forces, which is generated during the drilling operations. It should provide acceptable resistance against the formation forces and during stimulation jobs.

5.5.1 Demolding and Cutting

After the end of the condition period, samples are demolded and soaked into a container of hot or just warm water (depend on the curing temperature) to avoid cracking due to thermal shock. Further, the samples are cut by a machine by using a diamond blade cutter to achieve flat surfaces and obtain a distributed load, which leads to getting accurate results, however, according to research, the height of the specimen should be 2-3 larger than its diameter during the measurement of the compressive strength (Lavrov & Torsæter, 2016). On the other hand, the prepared sample is cut into two pieces since the required ratio of height to diameter is 0.2-

0.75, according to ASTM D3967-16. Keeping the samples inside the water before and after cutting to avoid the drying, which could result in cracking.

5.5.2 Mechanical Testing

There are two different ways to estimate the mechanical properties of the slurry, destructive test, and non-destructive one. Each of them has its benefits and shortcomings.

5.5.2.1 UCA

The ultrasonic cement analyzer provides the most accurate value of the compressive strength, where it supplies an elevated pressure and temperature (downhole conditions). This test analyzes the instant improvement of the sample strength during the time without the need to cut the samples. The process starts by putting the conditioned samples inside the analyzer at the required condition. The cylinder cell which carries the sample has connected with a sender and a receiver where the sender is located on the top of the cell while the receiver is at the bottom. An ultrasonic sound wave is generated from the sender, going through the sample, and finally is received at the receiver. A correlation is used to transfer the transit time of the wave to a compressive strength of the sample.

5.5.2.2 UCS

The uniaxial compression strength measures the mechanical properties of the paste by applying force axially until failure, so it is a destructive test. After preparing the sample for the test, the sample is dried before running the test. Its length and diameter at both ends are measured because the mold does not have a constant diameter along its length. The average diameter is used for the calculation. Further, the sample is placed at the center of the device (spreading the force all through the sample) and a force with a steady rate of 72 kN/m is applied until the sample is crushed. The result data (compressive load, test time and axial deformation) is used to calculate Young's modulus and the UCS. Figure 5-10 shows the sample is loaded in the machine, which is used to measure the compressive strength and Figure 5-11 illustrates the crushed sample after the test.



Figure 5-9 The Compressive Strength Machine



Figure 5-10 The Crushed Sample from uniaxial compressive strength test

5.5.2.3 Brazilian Test

It is an indirect method used to measure tensile strength. It has the same procedures as UCS except that the constant rate of the applied force is 50 kN/min, and the sample is situated inside an arched jaw instead of the flat platen of the machinery. The curved jaw helps to decline the contact stresses on the samples, as stated in ASTM 2016. Figure 5-11 displays the tensile strength machine and the sample is loaded inside the curved jaw while Figure 5-12 shows the sample after crushing.



Figure 5-11 The Tensile Strength Machine



Figure 5-12 The crushed Sample from Indirect Tensile strength test

5.6 Pumping Time

It defines the workability of the geopolymer through estimating how long the slurry is pumpable during field operations (Saeed Salehi et al., 2019). The software LabVIEW2018 is installed on the computer and linked to the consistometer through the cord and cables. When the consistometer is turned on, the container is rotated, and the data is recorded. Following the same steps of the conditioning until step No (8) to measure the consistency. The rotation of the slurry container is continued until the consistency of the sample reaches 100 BC, which refers to the final set of the sample according to API 10B-2 standard. There are two important values during the record, the initial set which takes place at 40 BC, and the final set at 100BC. Both of them define the quality and the workability of the geopolymer paste (*Petroleum and natural gas industries. Cement and materials for well cementing*, n.d.). Figure 5-13 highlights the trend of the geopolymer paste during the conditioning period until it is set. There are three zones; the first one, the consistency of the sample continues decreasing as the temperature increases. The second zone starts almost when the temperature reaches the defined value (65 °C) and stabilize at this value. This behavior lasts for a short time, and then the last action will take place as the sample will be gelled. The last zone will continue until the geopolymer paste is set (100 BC).

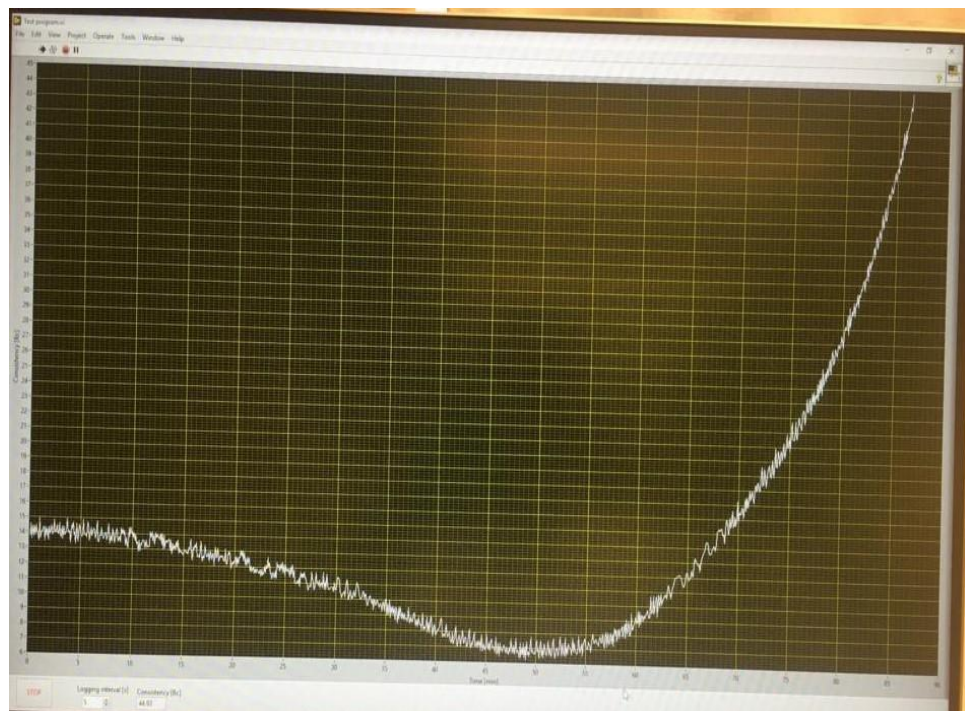

Figure 5-13 The Behavior of The geopolymer Paste during The Conditioning

6. Results and Discussions

6.1 Atmospheric Consistency Experiments

Several researches have been performed to find the retarding admixture, which could prolong the pumping time of the geopolymeric slurry. Some studies started using retarders, which showed good results with cement. In this thesis, a large number of chemicals are tested with different percentages and mixing designs. All experiments during this study have been applied using an atm consistometer. The temperature during the test is ramped up from ambient 25 °C to 65 °C (increase the temperature 5 degrees every 5 mins). All results are recorded and the data of consistometer with the time are plotted to show the pumpability of the geopolymer slurry.

The first test was run using the recipe of the base sample to study how long the sample could be pumped and then some retarding admixtures were added to the reference recipe to figure out their effects on the pumpability of the slurry. Figure 6-1 shows the pumping time of the reference recipe without and with different retarders.

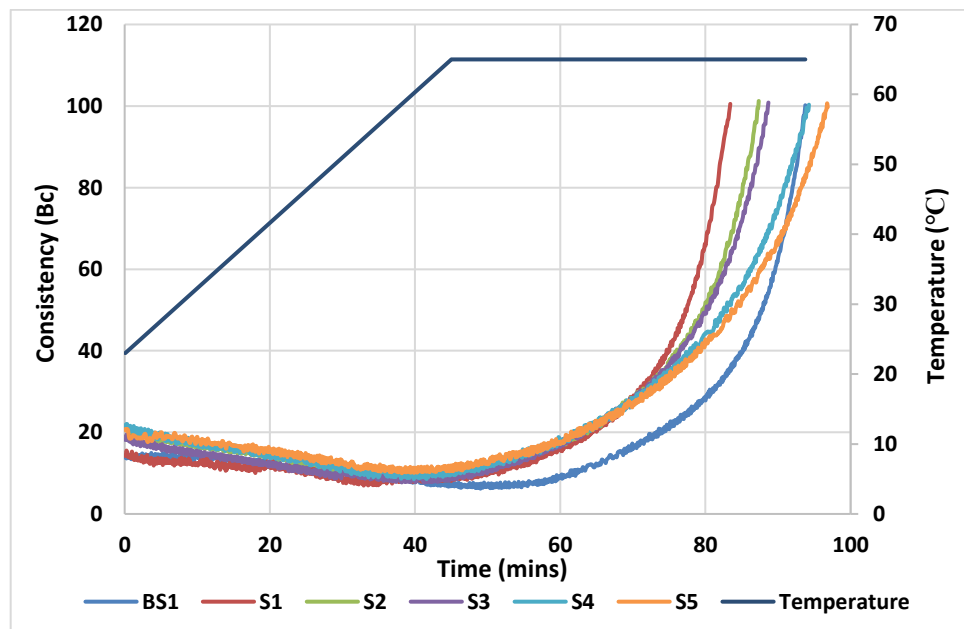

Figure 6-1 The Effect of Different Retarders on The Pumping Time

Table 6-1 The Initial and Final Setting Time of The Samples

Samples/ time mins	The initial setting at 40 BC	The final setting at 100 BC
BS1	85.2	93.7

S1	75	83.4
S2	76.4	87.3
S3	76.5	88.6
S4	78.2	94.2
S5	79.4	96.8

As shown in Figure 6-1 and Table 6-1, the base sample BS1 has a setting time longer than other samples. It revealed that those chemicals worked as an accelerator for geopolymer slurry. It is investigated that using different percentages of chemical K did not have any effect on the pumpability of the paste (S3, S4). Another test was conducted to investigate the effect of mixing design on the reaction of the hardener and precursor with the retarding admixture. In the sample S5, the components of hardener were combined first, and then the chemical was added to the mixture and mixed for 10 seconds before adding the precursor. On the other sample S5*, the chemical was added to the chemical W first, and then the mixture was added further to the remaining components of the hardener. Further, the precursor was added. Figure 6-2 shows the effect of adding the retarding admixture chemical H to the chemical W. It is investigated that S5* has longer setting time than S5 for both initial and final setting by 25 mins.

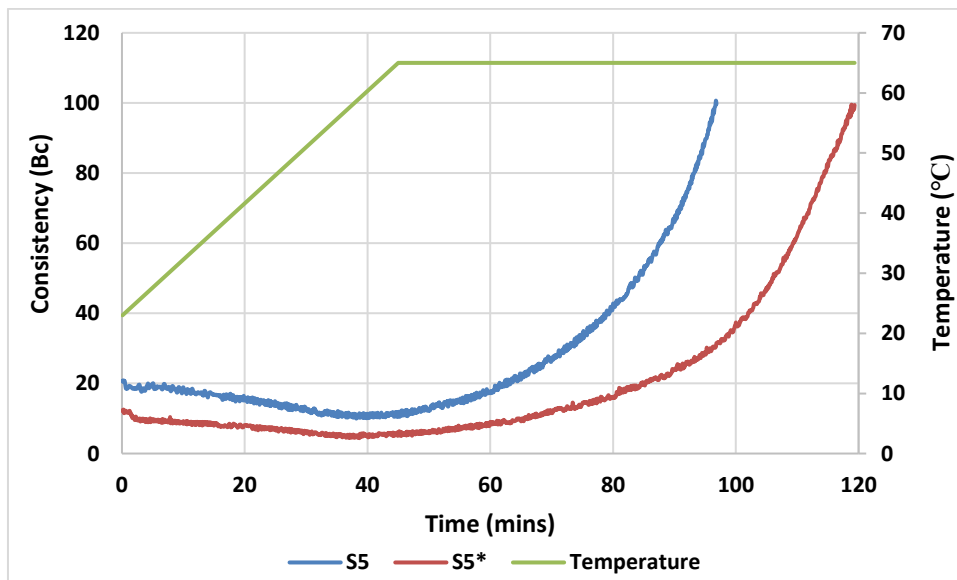

Figure 6-2 The effect of mix design on the setting time

Another test is performed using BS2, and the result was compared to the one from BS1. Figure 6-3 shows the effect of different recipes on the setting time of the geopolymer slurry. It is revealed that BS2 can be pumped for a longer time than BS1. Since BS2 shows a reasonable

pumping time, some retarding admixtures were used with it to prolong its setting time. All of them did not show any effect apart from chemical H. Figure 6-4 shows the behaviors of the retarding admixtures and its effect on the thickening time of the slurry.

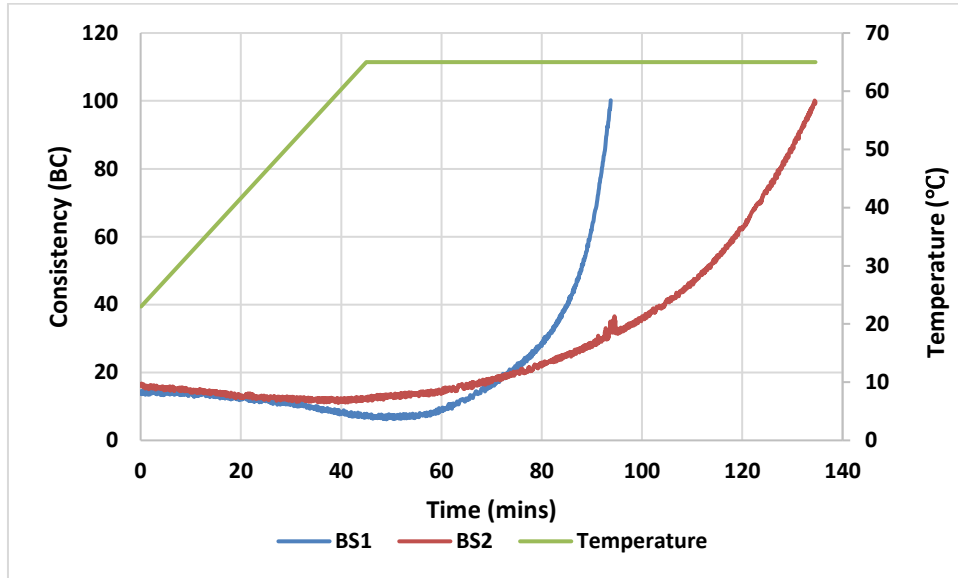

Figure 6-3 The impact of different recipes of the precursor

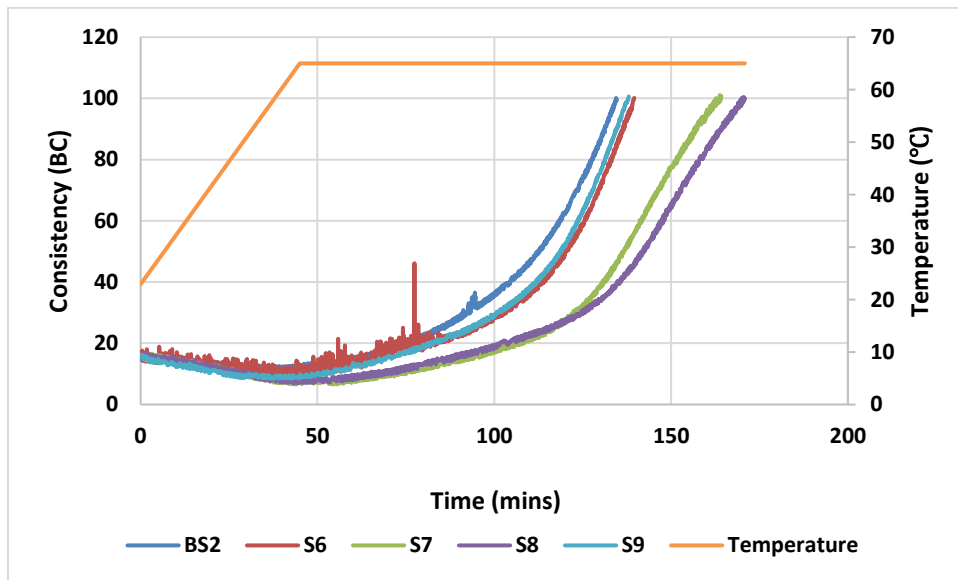

Figure 6-4 The Impact of Various Retarding Admixtures on The Thickening time

As it is demonstrated in Figure 6-4, the used retarding admixtures prolonged the initial and final setting time of the paste. S8 showed the best effect among the others, where chemical S and H were used as a retarding admixture. The trends of S6 and S9 reveal that the increase in the percentage of the retarder did not have any effect on the setting time. The same result was

revealed from the trends of S7 and S8. Other types of admixtures were used with the BS2, and their results are shown in Figure 6-5. It is revealed that the admixtures, which were used in S10 and S11 act as accelerators for the geopolymer slurry.

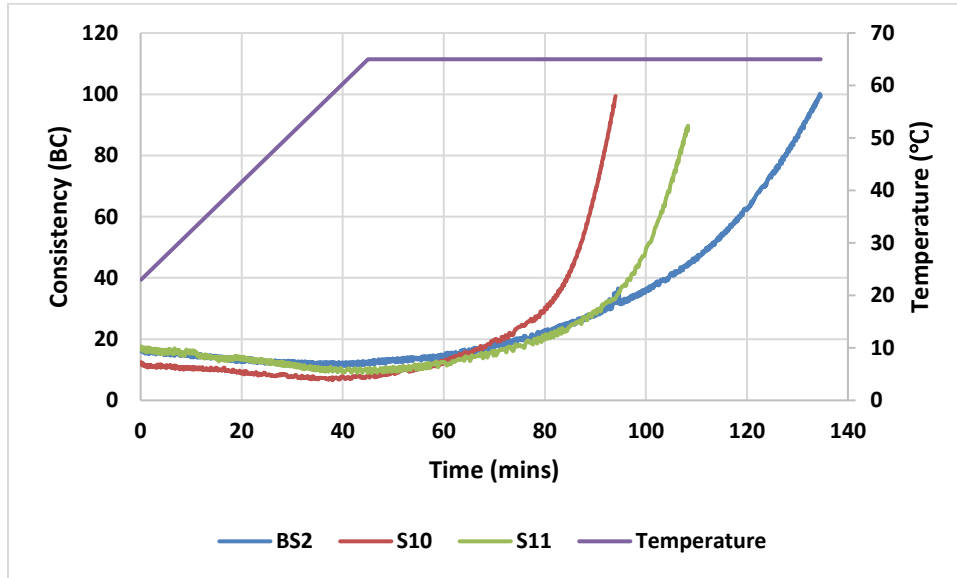

Figure 6-5 The Result of Others Retarding Admixtures

Other experiments were carried on using different modular ratios and study their behavior towards the pumping time of the geopolymer mortar. Figure 6-6 shows the results of the effect of different modular ratios on the setting time of the slurry. It is revealed that there is an optimum value of this ratio, which results in increasing the setting time of the slurry. Going beyond this value will lead to a decrease in the pumping time of the paste. As shown in Figure 6-6, S15 has the optimum value of the modular ratio. Increase or decrease in this ratio results in reducing the setting time as it is revealed through the behavior of S12 and S16.

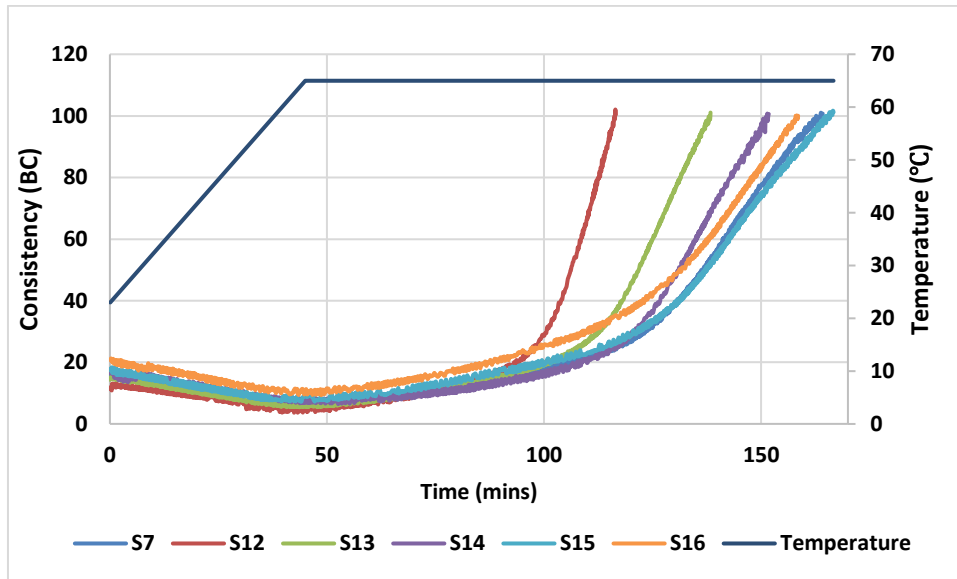

Figure 6-6 The Consequence of Using Different Modular Ratio on The Consistency

The consequence of using chemical W instead of chemical O has been studied through S11 and S11*. Both of them have the same recipe except S11* used chemical W instead of O. Figure 6-7 illustrates the comparison between S11 and S11*, where there is a bit difference between them.

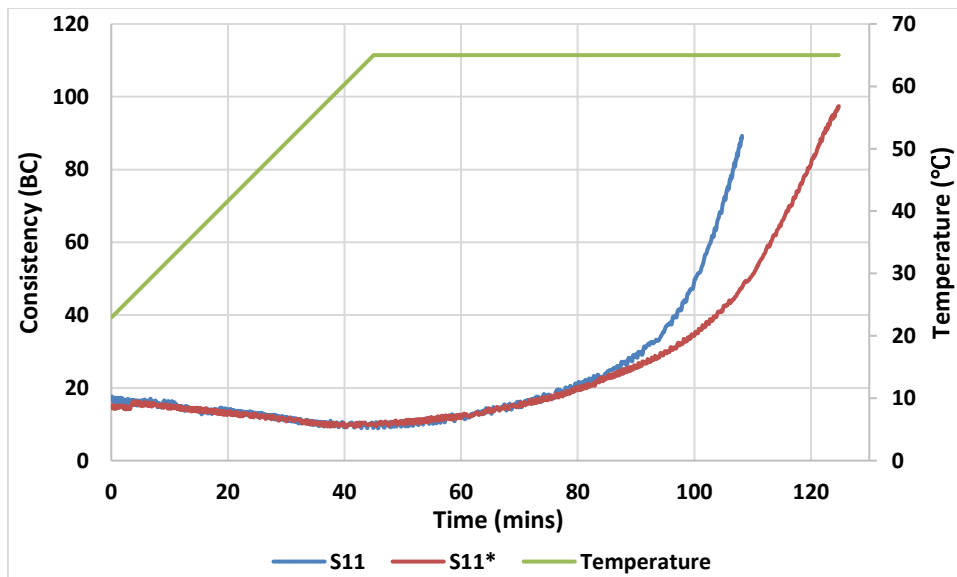

Figure 6-7 The Effect of Using chemical W instead of chemical O

6.2 Mechanical Test Results

First, the samples were cured under a temperature of 70 c for 7 days by putting the samples inside an autoclave, but the process did not go well. Several gas bubbles have been generated due to the existence of micro silica in the system whereas the reaction with metasilicate produces O₂, H₂ and H₂O₂. The bubbles started to immensely expand and flow over the molds as there is no external pressure on it. In fact, the formation of gas bubbles (i.e. O₂ and H₂, H₂O₂) cause expansion effect and compensate any possible shrinkage. Figure 6-8 and Figure 6-9 show the geopolymer sample containing gas bubbles and cracks along its body, and the cover of the mold was destroyed due to the gas pressure.

Therefore, the samples are put inside the cell and then inside the autoclave. The container of the samples is connected to a pump to provide a constant pressure while the oven provides the temperature; we need for conditioning the samples. The curing temperature and pressure during this project were 90°C and 2500 psi, respectively. After 7 curing days, the samples were prepared for mechanical testing by flattening its bottom and top surfaces.

During the compression and tensile test, we selected four samples whose highest pumping time to evaluate the effect of different retarder admixtures on the uniaxial compressive strength and tensile strength. In addition, measuring the rheology properties and density of them.



Figure 6-8 The Result of curing condition (under Atm Pressure)



Figure 6-9 The Consequences of Gas Bubbles on Curing

Figure 6-10 and Figure 6-11 show the results of compressive strength and tensile strength correspondingly. Several points have been concluded from Figure 6-10; S7 has a higher compressive strength than BS2 due to using chemical H. However, the increase in the amount of chemical H in the recipe will reduce the compression strength of the sample. S7 and S8 have the same modular ratio, but S8 has a double weight of chemical H than S7. The excess quantity of chemical H reduced the amount of compression strength even lower than the one without any retarding admixture (BS2). S7, S14 and S15 reveal the impact of modular ratio on the compressive strength. There is an optimum value of the modular ratio, which leads to an increase in the compressive strength. Up or down this value will result in a decrease in the strength of the sample.

The results of the tensile strength confirmed the concepts from the uniaxial compressive strength. S7 has the highest value among S8, S14 and S15. However, it is concluded from both figures that the modular ratio has a significant influence on the tensile strength than compressive strength, while the weight of retarder has a greater impact on the compressive strength.

Young's modulus cannot be calculated due to the drawbacks of the used machine. There are a lot of uncertainties that did not allow to estimate its value.

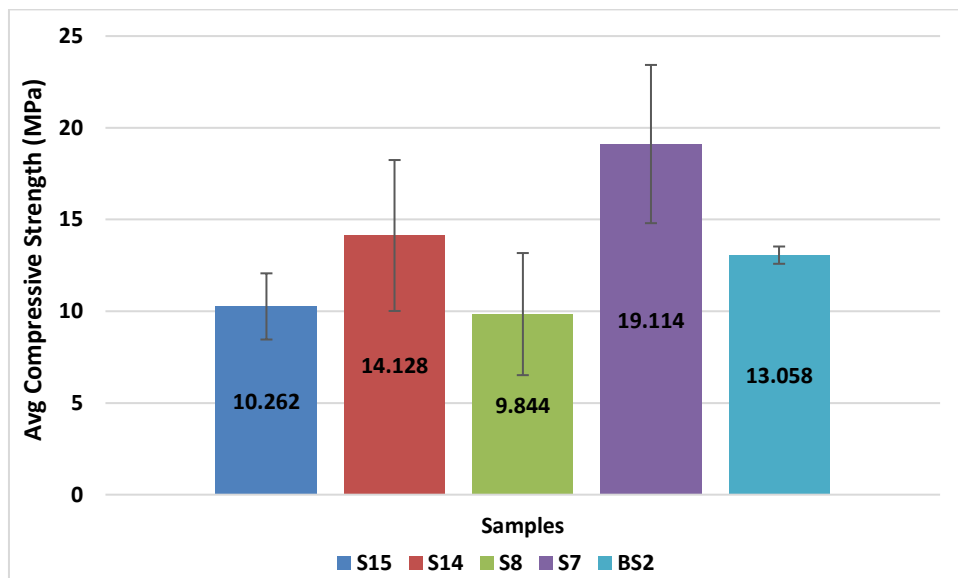

Figure 6-10 Uniaxial compressive strength results after 7 days of curing at 90°C and 2500 psi.

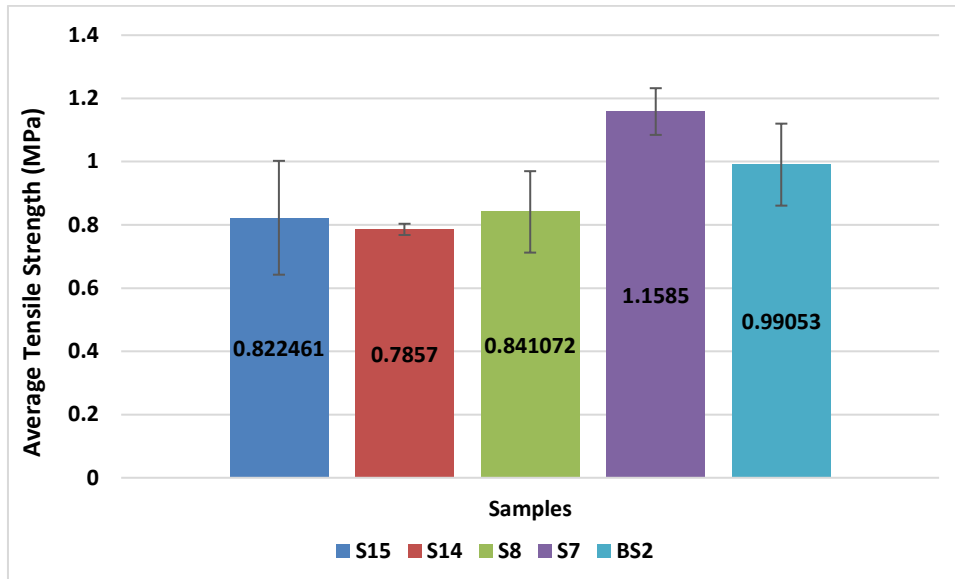

Figure 6-11 Tensile strength results from Brazilian test after 7 days of curing at 90°C and 2500 psi.

6.3 Uniaxial Cement Analyzer (UCA) Results

It is necessary to mention that the UCA system will not present an accurate data for geopolymer since the predefined algorithm is designed to estimate the sonic strength from the transit time for OPC (Khalifeh, Saasen, et al., 2019). So, a created algorithm is used to calculate approximately the value of the sonic strength of geopolymer from the transit time. Many samples of the same recipe should be cured for different days (1, 3, 5, and 7) and then crushed and tested for compression strength. Combining the data of both the compressive strength and the transit time will produce a good algorithm to estimate the sonic strength. However, it is important to cure the sample for a long period, for instance, 14, 28 and 56 days. Testing the sample for both UCA and UCS based on long term experiments might generate a more accurate algorithm and then a precise value of the sonic strength. Figure 6-12 shows the sonic strength of the four samples by using a generated algorithm ($Y = -136.98X^2 + 6103.7X - 66100$). It is demonstrated from Figure 6-12 that all samples have stabilized at almost the same value. However, they have started to build their strength at a different time. S14 started early after one day to develop its strength while S7 needed two days to begin its strength development. The other two samples delayed developing their strength. The strength of all samples, which are used retarders, has increased gradually while the slope of the base sample without any additives increased sharply. However, they levelled at the same value after 7 curing days.

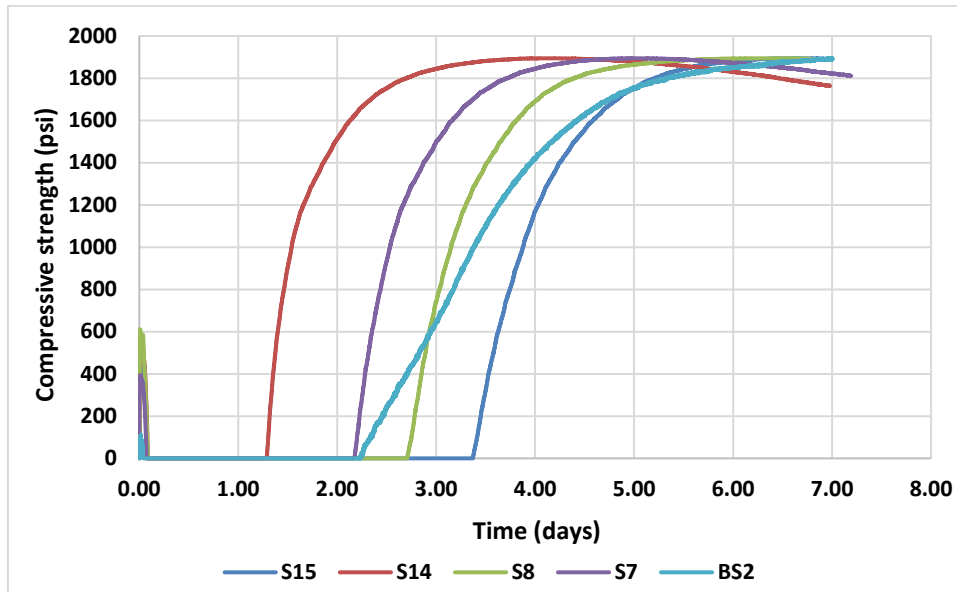

Figure 6-12 The Compressive Strength Results from UCA by Using A generated Algorithm.

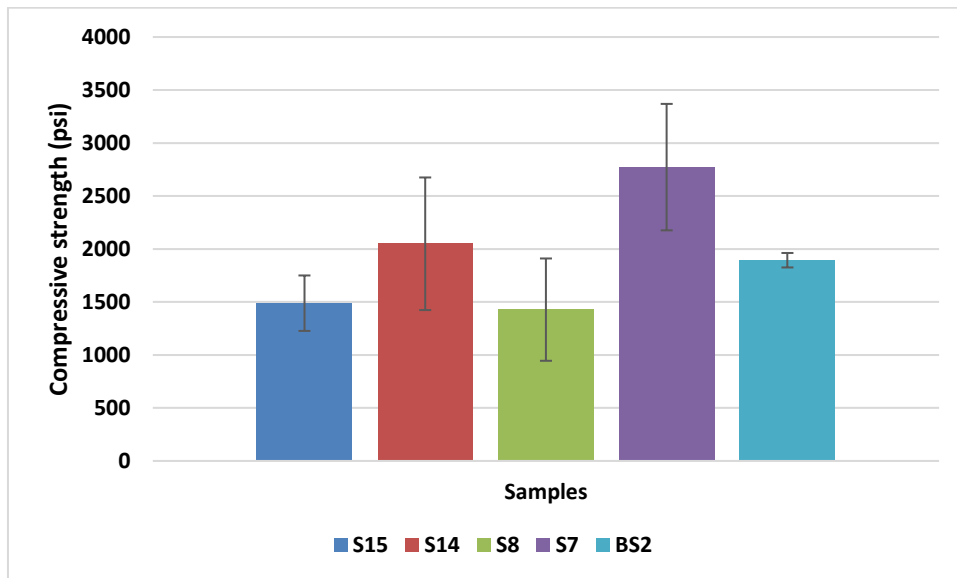

Figure 6-13 The Result of Compressive Strength from UCS after 7 days of curing at 90°C and 2500 psi.

Figure 6-12 and Figure 6-13 revealed that the values of compressive strength are unlike. Many samples should be cured using UCA for various days (1, 3, 5, 7, 14, 28 days) to get more accurate data of compressive strength.

6.3 Rheology results

Figure 6-14 and Figure 6-15 the results of rheology test of the geopolymers samples. It is clear that S7 and S8 have the same value of shear stress and higher than the others. So, chemical H increases the shear stress of the samples, but the increase in the weights of retarders does not increase the shear stress. Also, it is demonstrated from Figure 6-14 that the modular

ratio has a considerable effect on this value since S7, S15 and BS2 have a different value of the modular ratio. Furthermore, the rheology behavior of all samples demonstrates a non-Newtonian fluid. In addition, it is concluded from Figure 6-15 that the viscosity of all decreases as the shear rate increase, which points out to shear-thinning fluid.

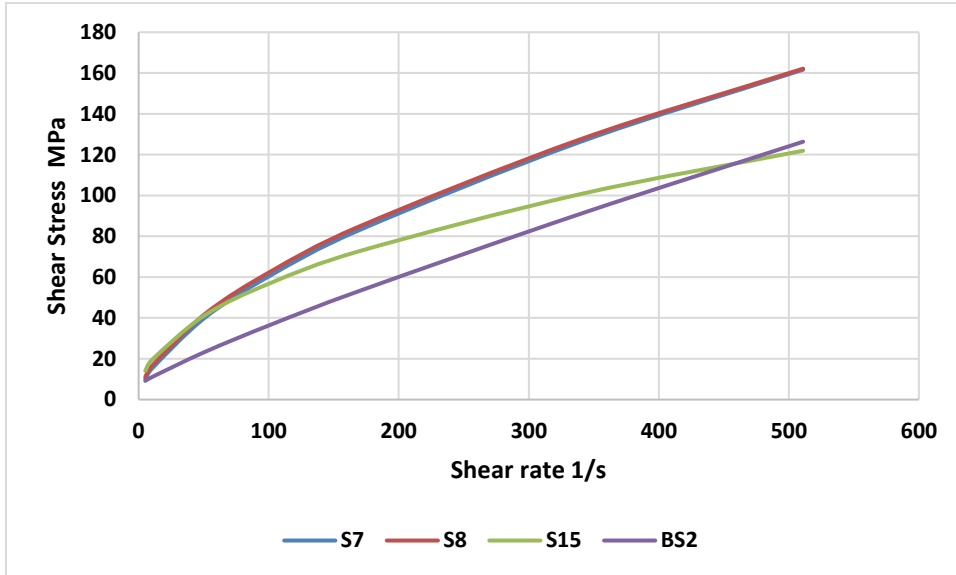

Figure 6-14 The Results of The Rheology properties of Geopolymer by Herschel-Buckley model

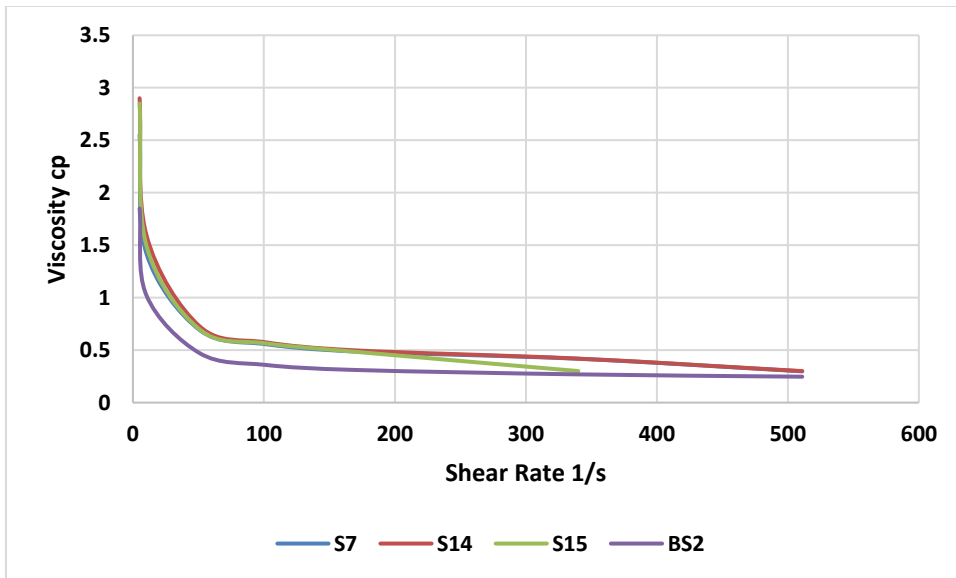

Figure 6-15 The Results of The Apparent Viscosity of Different Geopolymer Samples

7. Conclusion

Several studies and experiments demonstrated the potential of geopolymer to be a good alternative material to OPC for oil well cementing (primary cementing and P&A). It has many advantages on OPC, but it shows some shortcomings, which should be solved. One of these drawbacks is to reach certain pumping time and then setting time at elevated pressure and temperature. This project aimed to investigate numbers of retarders to figure out the appropriate one that could prolong the pumping time of the geopolymer without affecting adversely on the mechanical strength of the geopolymer.

The consistency result shows that chemicals, which are considered as cement retarder, work as an accelerator with the geopolymer. Chemicals (N, L and R) are applied to retard the pumping time of OPC. On the contrary, using these admixtures with geopolymer reduce the pumpability of the geopolymeric slurry.

Using only one kind of retarding admixture can increase the pumping time of the sampling while utilizing two different types of retarding together has the ability to prolong much more the pumpability. Chemical H and S together retard the setting time of the geopolymeric slurry more than using only one of them in the recipe.

Each retarding admixture has an optimum value to work as a retarder, using less or more than this value will lead to a reduction in its capability to retard the thickening time of the paste and could work adversely as an accelerator.

There are many parameters, which should be considered besides the retarding admixtures to prolong the pumping time of the geopolymer. The modular ratio plays a vital role in increasing the pumpability, and it has an optimal value, which could change according to the type and weight of the employed precursors. In addition, the composition of the solid phase has a significant influence on retarding the setting time.

Mixing the chemical, which is used as a retarder with one element of the hardener (chemical O or chemical W) first until it is completely dissolved and then add them to the hardener (the remaining components) has a significant effect than mixing all together at the same time. The retarding admixture finds the opportunity and the time to form chemical bonds in the first case, which promote its effect to delay the setting time of the paste.

This project is an extension for all previous studies, which showed good compressive strength results for geopolymer. The base geopolymer sample (without any additives) has a good compressive strength which satisfies the oil well cement requirements. Both of the amount of the retarding admixture and the modular ratio have a substantial effect on the mechanical

strength of the geopolymer. Using the optimal value of the admixture and modular ratio results in an increase in the value of compressive and tensile strength. Contrary, using less or more than the optimum value of both leads to a decrease in mechanical strength.

Geopolymer samples without and with additives showed a behavior of the non-Newtonian fluid, its viscosity decreases with the increase in the shear rate (shear thinning-fluid), and its density is within range of 1.9-1.95 g/cc at ambient temperature and pressure.

8. References

- Aghamir-Baha, S. (n.d.). *Measurement of Polymer Concentration and Optimization of Sludge Dewatering Using {UV}-{VIS} Spectroscopy* [Carleton University].
<https://doi.org/10.22215/etd/2014-10309>
- Alshamsi, A. M., Alhosani, K. I., & Yousri, K. M. (1997). Hydrophobic materials, superplasticizer and microsilica effects on setting of cement pastes at various temperatures. *Magazine of Concrete Research*, 49(179), 111–115.
<https://doi.org/10.1680/mac.1997.49.179.111>
- Aitcin, P.-C. (n.d.). The Use of Superplasticizers in High Performance Concrete. In *High Performance Concrete* (pp. 14–33). {CRC} Press.
<https://doi.org/10.1201/9780203752005-2>
- Andini, S., Cioffi, R., Colangelo, F., Grieco, T., Montagnaro, F., & Santoro, L. (2008). Coal fly ash as raw material for the manufacture of geopolymer-based products. *Waste Management*, 28(2), 416–423. <https://doi.org/10.1016/j.wasman.2007.02.001>
- Antoni, Wijaya, S. W., Satria, J., Sugiarto, A., & Hardjito, D. (2016). The Use of Borax in Deterring Flash Setting of High Calcium Fly Ash Based Geopolymer. *Materials Science Forum*, 857, 416–420. <https://doi.org/10.4028/www.scientific.net/msf.857.416>
- Autef, A., Joussein, E., Gasgnier, G., & Rossignol, S. (2013). Role of the silica source on the geopolymerization rate: A thermal analysis study. *Journal of Non-Crystalline Solids*, 366, 13–21. <https://doi.org/10.1016/j.jnoncrysol.2013.01.034>
- Babushkin, V. I., Matveyev, G. M., & Mchedlov-Petrosyan, O. P. (1985). The Basic Concepts and Laws of Thermodynamics. In *Thermodynamics of Silicates* (pp. 1–54). Springer Berlin Heidelberg. https://doi.org/10.1007/978-3-642-69320-5_1
- Bakharev, T. (2005). Geopolymeric materials prepared using Class F fly ash and elevated temperature curing. *Cement and Concrete Research*, 35(6), 1224–1232. <https://doi.org/10.1016/j.cemconres.2004.06.031>
- Banfill, P. F. G. (1998). Book {reviewsCement} and concrete Gani M. S. J. Chapman and Hall, London, 1997. 212pp. 0 41 279050 5. {\textsterling}24.95. *Advances in Cement Research*, 10(1), 41. <https://doi.org/10.1680/adcr.1998.10.1.41>
- Barbosa, V. F. F., & MacKenzie, K. J. D. (2003). Synthesis and thermal behaviour of potassium sialate geopolymers. *Materials Letters*, 57(9–10), 1477–1482. [https://doi.org/10.1016/s0167-577x\(02\)01009-1](https://doi.org/10.1016/s0167-577x(02)01009-1)
- Barbosa, V. F. F., MacKenzie, K. J. D., & Thaumaturgo, C. (2000). Synthesis and

- characterisation of materials based on inorganic polymers of alumina and silica: sodium polysialate polymers. *International Journal of Inorganic Materials*, 2(4), 309–317. [https://doi.org/10.1016/s1466-6049\(00\)00041-6](https://doi.org/10.1016/s1466-6049(00)00041-6)
- Beharie, C., Francis, S., & Øvestad, K. H. (2015). Resin: An Alternative Barrier Solution Material. *{SPE} Bergen One Day Seminar*. <https://doi.org/10.2118/173852-ms>
- Brearley, G. (1990). Third {CANMET}/{ACI} international conference on superplasticisers and other chemical admixtures in concrete. 4{\textendash}6 October 1989, Ottawa, Canada. *Cement and Concrete Composites*, 12(2), 140–141. [https://doi.org/10.1016/0958-9465\(90\)90052-y](https://doi.org/10.1016/0958-9465(90)90052-y)
- BRUERE, G. M. (1966). Set-retarding Effects of Sugars in Portland Cement Pastes. *Nature*, 212(5061), 502–503. <https://doi.org/10.1038/212502a0>
- Chandra, S., & Björnström, J. (2002). Influence of cement and superplasticizers type and dosage on the fluidity of cement mortars{\textendash}Part I. *Cement and Concrete Research*, 32(10), 1605–1611. [https://doi.org/10.1016/s0008-8846\(02\)00839-6](https://doi.org/10.1016/s0008-8846(02)00839-6)
- Chemical Admixtures for Concrete. (1989). *{ACI} Materials Journal*, 86(3). <https://doi.org/10.14359/2460>
- Chindaprasirt, P., Chareerat, T., & Sirivivatnanon, V. (2007). Workability and strength of coarse high calcium fly ash geopolymer. *Cement and Concrete Composites*, 29(3), 224–229. <https://doi.org/10.1016/j.cemconcomp.2006.11.002>
- Colleparidi, M. M. (1996). Water Reducers/Retarders. In *Concrete Admixtures Handbook* (pp. 286–409). Elsevier. <https://doi.org/10.1016/b978-081551373-5.50010-6>
- Collins, F., & Sanjayan, J. G. (2001). Microcracking and strength development of alkali activated slag concrete. *Cement and Concrete Composites*, 23(4–5), 345–352. [https://doi.org/10.1016/s0958-9465\(01\)00003-8](https://doi.org/10.1016/s0958-9465(01)00003-8)
- Davidovits, J. (1991). Geopolymers. *Journal of Thermal Analysis*, 37(8), 1633–1656. <https://doi.org/10.1007/bf01912193>
- Davidovits, Joseph. (2011). *Geopolymer Chemistry and Applications 3 rd edition*.
- Davidovits, Joseph, Huaman, L., & Davidovits, R. (2019). Ancient geopolymer in south-American monument. {SEM} and petrographic evidence. *Materials Letters*, 235, 120–124. <https://doi.org/10.1016/j.matlet.2018.10.033>
- Dawy, M., Shabaka, A. A., & Nada, A. M. A. (1998). Molecular structure and dielectric properties of some treated lignins. *Polymer Degradation and Stability*, 62(3), 455–462. [https://doi.org/10.1016/s0141-3910\(98\)00026-3](https://doi.org/10.1016/s0141-3910(98)00026-3)
- Design of concrete mixtures for durability. (2017). In *Durability of Concrete* (pp. 263–278).

- {CRC} Press. <https://doi.org/10.1201/9781315118413-10>
- DIAMOND, S. (1972). Interactions Between Cement Minerals and Hydroxycarboxylic-Acid Retarders: {III}, Infrared Spectral Identification of the Aluminosalicylate Complex. *Journal of the American Ceramic Society*, 55(8), 405–408. <https://doi.org/10.1111/j.1151-2916.1972.tb11322.x>
- Dimas, D., Giannopoulou, I., & Panias, D. (2009). Polymerization in sodium silicate solutions: a fundamental process in geopolymerization technology. *Journal of Materials Science*, 44(14), 3719–3730. <https://doi.org/10.1007/s10853-009-3497-5>
- Duong, N. A., & Škvára, F. (2016). Factors Influencing the Long-Term Properties of Fly Ash-Based Geopolymer Mortar. *Advances in Civil Engineering Materials*, 5(1), 20160002. <https://doi.org/10.1520/acem20160002>
- Duxson, P., Fernández-Jiménez, A., Provis, J. L., Lukey, G. C., Palomo, A., & van Deventer, J. S. J. (2006). Geopolymer technology: the current state of the art. *Journal of Materials Science*, 42(9), 2917–2933. <https://doi.org/10.1007/s10853-006-0637-z>
- Favier, A., Habert, G., d\textquotessingleEspinose de Lacaillerie, J. B., & Roussel, N. (2013). Mechanical properties and compositional heterogeneities of fresh geopolymer pastes. *Cement and Concrete Research*, 48, 9–16. <https://doi.org/10.1016/j.cemconres.2013.02.001>
- Fernández-Jiménez, A., & Palomo, A. (2005). Composition and microstructure of alkali activated fly ash binder: Effect of the activator. *Cement and Concrete Research*, 35(10), 1984–1992. <https://doi.org/10.1016/j.cemconres.2005.03.003>
- Fernández-Jiménez, A., & Palomo, A. (2009). Chemical durability of geopolymers. In *Geopolymers* (pp. 167–193). Elsevier. <https://doi.org/10.1533/9781845696382.2.167>
- Fernández-Jiménez, A., Palomo, A., & Criado, M. (2005). Microstructure development of alkali-activated fly ash cement: a descriptive model. *Cement and Concrete Research*, 35(6), 1204–1209. <https://doi.org/10.1016/j.cemconres.2004.08.021>
- Fernando, P.-T., João, C.-G., & Said, J. (2010). Durability and Environmental Performance of Alkali-Activated Tungsten Mine Waste Mud Mortars. *Journal of Materials in Civil Engineering*, 22(9), 897–904. [https://doi.org/10.1061/\(asce\)mt.1943-5533.0000092](https://doi.org/10.1061/(asce)mt.1943-5533.0000092)
- Gong, C., & Yang, N. (2000). Effect of phosphate on the hydration of alkali-activated red mud{\textendash}slag cementitious material. *Cement and Concrete Research*, 30(7), 1013–1016. [https://doi.org/10.1016/s0008-8846\(00\)00260-x](https://doi.org/10.1016/s0008-8846(00)00260-x)
- Gunter, M. M. (2016). Erdo{\u{g}}an and the Decline of Turkey. *Middle East Policy*, 23(4), 123–135. <https://doi.org/10.1111/mepo.12238>

- Harr, K. (1991). Erkenntnisse über Zement: H. F. W. Taylor: {\textquotedblleft}Cement Chemistry{\textquotedblright}. Academic Press, London 1990. 475 S., geb., {\textdollar} 51.00. {ISBN} 0-12-683900-X. *Nachrichten Aus Chemie, Technik Und Laboratorium*, 39(3), 322. <https://doi.org/10.1002/nadc.19910390317>
- Helland, S. (2013). Service life design of concrete structures: the limit state and reliability-based approach given in fib {MC} {SLD} and {ISO} 16204. *International Journal of Structural Engineering*, 4(1/2), 14. <https://doi.org/10.1504/ijstructe.2013.050761>
- Hendriks, C. A., Worrell, E., Price, L., Martin, N., Meida, L. O., de Jager, D., & Riemer, P. (1999). Emission reduction of greenhouse gases from the cement industry. In *Greenhouse Gas Control Technologies 4* (pp. 939–944). Elsevier. <https://doi.org/10.1016/b978-008043018-8/50150-8>
- Hewlett, P. P. C. (1998). Preface. In *Leaf\textquotesingle}s Chemistry of Cement and Concrete* (pp. xix--xxi). Elsevier. <https://doi.org/10.1016/b978-075066256-7/50009-6>
- Improved Air-Entraining Admixtures for Concrete. (1968). *{ACI} Journal Proceedings*, 65(5). <https://doi.org/10.14359/7481>
- Jackson, P. B., & Murphey, C. E. (1993). Effect of Casing Pressure on Gas Flow Through a Sheath of Set Cement. *{SPE}/{IADC} Drilling Conference*. <https://doi.org/10.2118/25698-ms>
- Janotka, I., Krajči, L., & Dzivák, M. (2003). Properties and Utilization of Zeolite-blended Portland Cements. *Clays and Clay Minerals*, 51(6), 616–624. <https://doi.org/10.1346/ccmn.2003.0510606>
- Kaeding, A. O. (2018). A Perspective on 40 Years of Polymers in Concrete History. In *International Congress on Polymers in Concrete ({ICPIC} 2018)* (pp. 321–327). Springer International Publishing. https://doi.org/10.1007/978-3-319-78175-4_40
- Karakoç, M. B., Türkmen, \.Ibrahim, Mara\cs, M. M., Kantarci, F., Demirbo\uga, R., & Toprak, M. U. (2014). Mechanical properties and setting time of ferrochrome slag based geopolymer paste and mortar. *Construction and Building Materials*, 72, 283–292. <https://doi.org/10.1016/j.conbuildmat.2014.09.021>
- Khale, D., & Chaudhary, R. (2007). Mechanism of geopolymerization and factors influencing its development: a review. *Journal of Materials Science*, 42(3), 729–746. <https://doi.org/10.1007/s10853-006-0401-4>
- Khalifeh, M., Hodne, H., Saasen, A., Integrity, O., & Eduok, E. I. (2016). Usability of Geopolymers for Oil Well Cementing Applications: Reaction Mechanisms, Pumpability, and Properties. *{SPE} Asia Pacific Oil & Gas Conference and Exhibition*.

<https://doi.org/10.2118/182354-ms>

- Khalifeh, M., Saasen, A., Hodne, H., Godøy, R., & Vrålstad, T. (2018). Geopolymers as an alternative for oil well cementing applications: A review of advantages and concerns. *Journal of Energy Resources Technology, Transactions of the ASME*, 140(9), 1–7. <https://doi.org/10.1115/1.4040192>
- Khalifeh, M., Saasen, A., Hodne, H., & Motra, H. B. (2019). Laboratory evaluation of rock-based geopolymers for zonal isolation and permanent P&A applications. *Journal of Petroleum Science and Engineering*, 175, 352–362. <https://doi.org/10.1016/j.petrol.2018.12.065>
- Khalifeh, M., Saasen, A., Vralstad, T., & Hodne, H. (2014). Potential Utilization of Geopolymers in Plug and Abandonment Operations. *{SPE} Bergen One Day Seminar*. <https://doi.org/10.2118/169231-ms>
- Khalifeh, M., Saasen, A., Vrålstad, T., Larsen, H. B., & Hodne, H. (2015). Cap Rock Restoration in Plug and Abandonment Operations; Possible Utilization of Aplite-Based Geopolymers for Permanent Zonal Isolation and Well Plugging. *{SPE} Offshore Europe Conference and Exhibition*. <https://doi.org/10.2118/175457-ms>
- Khalifeh, M., Salehi, S., Jamrozik, A., Kimanzi, R., & Abdollahpour, S. (2019, June). Nano-Modified Rock-Based Geopolymers As Supplement to Portland Cement for Oil Well Cementing. *Volume 8: Polar and Arctic Sciences and Technology; Petroleum Technology*. <https://doi.org/10.1115/omae2019-95380>
- Khalifeh, M., Todorovic, J., Vrålstad, T., Saasen, A., & Hodne, H. (2016). Long-term durability of rock-based geopolymers aged at downhole conditions for oil well cementing operations. *Journal of Sustainable Cement-Based Materials*, 6(4), 217–230. <https://doi.org/10.1080/21650373.2016.1196466>
- Koleżyński, A., Król, M., & Żychowicz, M. (2018). The structure of geopolymers {textendash} Theoretical studies. *Journal of Molecular Structure*, 1163, 465–471. <https://doi.org/10.1016/j.molstruc.2018.03.033>
- Komnitsas, K., & Zaharaki, D. (2007). Geopolymerisation: A review and prospects for the minerals industry. *Minerals Engineering*, 20(14), 1261–1277. <https://doi.org/10.1016/j.mineng.2007.07.011>
- Krizan, D., & Zivanovic, B. (2002). Effects of dosage and modulus of water glass on early hydration of alkali{textendash}slag cements. *Cement and Concrete Research*, 32(8), 1181–1188. [https://doi.org/10.1016/s0008-8846\(01\)00717-7](https://doi.org/10.1016/s0008-8846(01)00717-7)
- Kusbiantoro, A., Ibrahim, M. S., Muthusamy, K., & Alias, A. (2013). Development of Sucrose

- and Citric Acid as the Natural based Admixture for Fly Ash based Geopolymer. *Procedia Environmental Sciences*, 17, 596–602. <https://doi.org/10.1016/j.proenv.2013.02.075>
- Lavrov, A., & Torsæter, M. (2016). Introduction. In *{SpringerBriefs} in Petroleum Geoscience & Engineering* (pp. 1–7). Springer International Publishing. https://doi.org/10.1007/978-3-319-43165-9_1
- Liew, Y.-M., Heah, C.-Y., Mustafa, A. B. M., & Kamarudin, H. (2016). Structure and properties of clay-based geopolymer cements: A review. *Progress in Materials Science*, 83, 595–629. <https://doi.org/10.1016/j.pmatsci.2016.08.002>
- Liu, H., Sanjayan, J. G., & Bu, Y. (2017). The application of sodium hydroxide and anhydrous borax as composite activator of class F fly ash for extending setting time. *Fuel*, 206, 534–540. <https://doi.org/10.1016/j.fuel.2017.06.049>
- Lizcano, M., Kim, H. S., Basu, S., & Radovic, M. (2011). Mechanical properties of sodium and potassium activated metakaolin-based geopolymers. *Journal of Materials Science*, 47(6), 2607–2616. <https://doi.org/10.1007/s10853-011-6085-4>
- Mahmoudkhani, A. H., Huynh, D., Sylvestre, C. J., & Schneider, J. (2008). New Environment-Friendly Cement Slurries With Enhanced Mechanical Properties for Gas Well Cementing. *{CIPC}/{SPE} Gas Technology Symposium 2008 Joint Conference*. <https://doi.org/10.2118/115004-ms>
- Mailvaganam, N. P., Rixom, M. R., Manson, D. P., & Gonzales, C. (1999). *Chemical Admixtures for Concrete*. {CRC} Press. <https://doi.org/10.4324/9780203017241>
- Mindess, S. (2008). Concrete Constituent Materials. In *Concrete Construction Engineering Handbook*. {CRC} Press. <https://doi.org/10.1201/9781420007657.ch1>
- Mizuno, M., & Shioiri, T. (2010). {ChemInform} Abstract: Reaction of Carboxylic Acids with Diethyl Phosphorocyanidate a Novel Synthesis of Homologated α -Hydroxycarboxylic Acids from Carboxylic Acids. *ChemInform*, 30(9), no--no. <https://doi.org/10.1002/chin.199909092>
- Monteiro, P. J. M., Gjørv, O. E., & Mehta, P. K. (1985). Microstructure of the steel-cement paste interface in the presence of chloride. *Cement and Concrete Research*, 15(5), 781–784. [https://doi.org/10.1016/0008-8846\(85\)90143-7](https://doi.org/10.1016/0008-8846(85)90143-7)
- Nadir, Y., & Sujatha, A. (2018). Bond strength determination between coconut shell aggregate concrete and steel reinforcement by pull-out test. *Asian Journal of Civil Engineering*, 19(6), 713–723. <https://doi.org/10.1007/s42107-018-0060-1>
- Nasvi, M. C. M., Ranjith, P. G., & Sanjayan, J. (2014). Effect of different mix compositions on apparent carbon dioxide (CO_2) permeability of geopolymer: Suitability as well cement

- for {CO}₂ sequestration wells. *Applied Energy*, 114, 939–948.
<https://doi.org/10.1016/j.apenergy.2013.05.050>
- Nematollahi, B., & Sanjayan, J. (2014). Efficacy of Available Superplasticizers on Geopolymers. *Research Journal of Applied Sciences, Engineering and Technology*, 7(7), 1464–1468. <https://doi.org/10.19026/rjaset.7.420>
- Nematollahi, B., Sanjayan, J., & Shaikh, F. U. A. (2015). Tensile Strain Hardening Behavior of {PVA} Fiber-Reinforced Engineered Geopolymer Composite. *Journal of Materials in Civil Engineering*, 27(10), 4015001. [https://doi.org/10.1061/\(asce\)mt.1943-5533.0001242](https://doi.org/10.1061/(asce)mt.1943-5533.0001242)
- Neville, R. C. (1995). {ADVANCED} {APPROACHES}. In *Solar Energy Conversion* (pp. 257–300). Elsevier. <https://doi.org/10.1016/b978-044489818-0/50007-7>
- Nuruddin, M. F. N., Kusbiantoro, A. K., Qazi, S. Q., Darmawan, M. S. D., & Husin, N. A. H. (2011). Development of Geopolymer Concrete with Different Curing Conditions. *{IPTEK} The Journal for Technology and Science*, 22(1). <https://doi.org/10.12962/j20882033.v22i1.54>
- Paiva, M. D. M., Silva, E. C. C. M., Melo, D. M. A., Martinelli, A. E., & Schneider, J. F. (2018). A geopolymer cementing system for oil wells subject to steam injection. *Journal of Petroleum Science and Engineering*, 169, 748–759. <https://doi.org/10.1016/j.petrol.2018.06.022>
- Panagiotopoulou, C., Kontori, E., Perraki, T., & Kakali, G. (2006). Dissolution of aluminosilicate minerals and by-products in alkaline media. *Journal of Materials Science*, 42(9), 2967–2973. <https://doi.org/10.1007/s10853-006-0531-8>
- Park, Y.-S., Suh, J.-K., Lee, J.-H., & Shin, Y.-S. (1999). Strength deterioration of high strength concrete in sulfate environment. *Cement and Concrete Research*, 29(9), 1397–1402. [https://doi.org/10.1016/s0008-8846\(99\)00106-4](https://doi.org/10.1016/s0008-8846(99)00106-4)
- Petroleum and natural gas industries. Cements and materials for well cementing*. (n.d.). {BSI} British Standards. <https://doi.org/10.3403/02964072u>
- Poulesquen, A., Frizon, F., & Lambertin, D. (2011). Rheological behavior of alkali-activated metakaolin during geopolymerization. *Journal of Non-Crystalline Solids*, 357(21), 3565–3571. <https://doi.org/10.1016/j.jnoncrysol.2011.07.013>
- Prinsse, S., Hordijk, D. A., Ye, G., Lagendijk, P., & Luković, M. (2019). Time-dependent material properties and reinforced beams behavior of two alkali-activated types of concrete. *Structural Concrete*. <https://doi.org/10.1002/suco.201900235>
- Provis, J. L., & Deventer, J. S. J. Van. (2009). Introduction to geopolymers. In *Geopolymers* (pp. 1–11). Elsevier. <https://doi.org/10.1533/9781845696382.1>

- Provis, J. L., & Rees, C. A. (2009). Geopolymer synthesis kinetics. In *Geopolymers* (pp. 118–136). Elsevier. <https://doi.org/10.1533/9781845696382.1.118>
- Raijiwala, D. B., & Patil, H. S. (2010, November). Geopolymer concrete A green concrete. *2010 2nd International Conference on Chemical, Biological and Environmental Engineering*. <https://doi.org/10.1109/icbee.2010.5649609>
- Ramachandran, V. S. (1996). Preface to the First Edition. In *Concrete Admixtures Handbook* (pp. ix--x). Elsevier. <https://doi.org/10.1016/b978-081551373-5.50002-7>
- Ramachandran, V. S., & Feldman, R. F. (1996). Concrete Science. In *Concrete Admixtures Handbook* (pp. 1–66). Elsevier. <https://doi.org/10.1016/b978-081551373-5.50005-2>
- Ramachandran, V. S., & Lowery, M. S. (1992). Conduction calorimetric investigation of the effect of retarders on the hydration of Portland cement. *Thermochimica Acta*, *195*, 373–387. [https://doi.org/10.1016/0040-6031\(92\)80081-7](https://doi.org/10.1016/0040-6031(92)80081-7)
- Rangan, B. V. (n.d.). Design, Properties, and Applications of Low-Calcium Fly Ash-Based Geopolymer Concrete. In *Developments in Porous, Biological and Geopolymer Ceramics* (pp. 347–362). John Wiley & Sons, Inc. <https://doi.org/10.1002/9780470339749.ch31>
- Rashad, A. M., & Zeedan, S. R. (2011). The effect of activator concentration on the residual strength of alkali-activated fly ash pastes subjected to thermal load. *Construction and Building Materials*, *25*(7), 3098–3107. <https://doi.org/10.1016/j.conbuildmat.2010.12.044>
- Rees, C. A., Provis, J. L., Lukey, G. C., & van Deventer, J. S. J. (2008). The mechanism of geopolymer gel formation investigated through seeded nucleation. *Colloids and Surfaces A: Physicochemical and Engineering Aspects*, *318*(1–3), 97–105. <https://doi.org/10.1016/j.colsurfa.2007.12.019>
- Rooses, A., Steins, P., Dannoux-Papin, A., Lambertin, D., Poulesquen, A., & Frizon, F. (2013). Encapsulation of Mg{textendash}Zr alloy in metakaolin-based geopolymer. *Applied Clay Science*, *73*, 86–92. <https://doi.org/10.1016/j.clay.2012.09.023>
- Ryu, G. S., Lee, Y. B., Koh, K. T., & Chung, Y. S. (2013). The mechanical properties of fly ash-based geopolymer concrete with alkaline activators. *Construction and Building Materials*, *47*, 409–418. <https://doi.org/10.1016/j.conbuildmat.2013.05.069>
- Sagoe-Crentsil, K., & Weng, L. (2006). Dissolution processes, hydrolysis and condensation reactions during geopolymer synthesis: Part {II}. High Si/Al ratio systems. *Journal of Materials Science*, *42*(9), 3007–3014. <https://doi.org/10.1007/s10853-006-0818-9>
- Salehi, S., Khattak, M. J., Ali, N., & Rizvi, H. R. (2016). Development of geopolymer-based cement slurries with enhanced thickening time, compressive and shear bond strength and durability. *SPE - International Association of Drilling Contractors Drilling Conference*

- Proceedings, 2016-Janua*. <https://doi.org/10.2118/178793-ms>
- Salehi, Saeed, Khattak, J., Saleh, F. K., & Igbojekwe, S. (2019). Investigation of mix design and properties of geopolymers for application as wellbore cement. *Journal of Petroleum Science and Engineering*, *178*(July 2018), 133–139. <https://doi.org/10.1016/j.petrol.2019.03.031>
- Salehi, Saeed, Khattak, M. J., Rizvi, H., Karbalaei, S. F., & Kiran, R. (2017). Sensitivity analysis of fly ash geopolymer cement slurries: Implications for oil and gas wells cementing applications. *Journal of Natural Gas Science and Engineering*, *37*, 116–125. <https://doi.org/10.1016/j.jngse.2016.11.025>
- Shaikh, F. U. A., & Vimonsatit, V. (2014). Compressive strength of fly-ash-based geopolymer concrete at elevated temperatures. *Fire and Materials*, *39*(2), 174–188. <https://doi.org/10.1002/fam.2240>
- Shalbafan, A., & Thoemen, H. (2020). Geopolymer-Bonded Laminated Veneer Lumber as Environmentally Friendly and Formaldehyde-Free Product: Effect of Various Additives on Geopolymer Binder Features. *Applied Sciences*, *10*(2), 593. <https://doi.org/10.3390/app10020593>
- Shrotri, K. N., Shervington, J. P., & Shrotri, N. C. (2009). Laser excision of encrusted intravesical tension-free vaginal tape (TVT). *International Urogynecology Journal*, *21*(3), 375–377. <https://doi.org/10.1007/s00192-009-0960-4>
- Struble, L., Kim, E., & Gómez-Zamorano, L. (2013). Overview of Geopolymer Cement. In *Geopolymer Binder Systems* (pp. 1–10). {ASTM} International. <https://doi.org/10.1520/stp156620120106>
- Sugumaran, M. (2015). Study on Effect of Low Calcium Fly Ash on Geopolymer Cement for Oil Well Cementing. *{SPE}/{IATMI} Asia Pacific Oil & Gas Conference and Exhibition*. <https://doi.org/10.2118/176454-ms>
- Supriadi, W., Subaer, Bayuaji, R., Burhan, R. Y. P., & Fansuri, H. (2016). The Effect of Pb^{2+} and Cd^{2+} Addition to Mechanical Properties of Fly Ash Geopolymer Paste. *Materials Science Forum*, *841*, 178–185. <https://doi.org/10.4028/www.scientific.net/msf.841.178>
- Suwan, T. (2016). *DEVELOPMENT OF SELF-CURED GEOPOLYMER CEMENT A thesis submitted for the degree of Doctor of Philosophy by Department of Mechanical , Aerospace & March*, 60.
- Swenson, E. G., & Thorvaldson, T. (n.d.). Detection of Lignosulfonate Retarder in Cement

- Suspensions and Pastes. In *Symposium on Effect of Water-Reducing Admixtures and Set-Retarding Admixtures on Properties of Concrete* (pp. 111–159). {ASTM} International. <https://doi.org/10.1520/stp39574s>
- Telysheva, G., Dizhbite, T., Paegle, E., Shapatin, A., & Demidov, I. (2001). Surface-active properties of hydrophobized derivatives of lignosulfonates: Effect of structure of organosilicon modifier. *Journal of Applied Polymer Science*, 82(4), 1013–1020. <https://doi.org/10.1002/app.1935>
- Thomas, N. L., Jameson, D. A., & Double, D. D. (1981). The effect of lead nitrate on the early hydration of portland cement. *Cement and Concrete Research*, 11(1), 143–153. [https://doi.org/10.1016/0008-8846\(81\)90017-x](https://doi.org/10.1016/0008-8846(81)90017-x)
- van Oort, E., Juenger, M., Liu, X., & McDonald, M. (2019). Silicate-Activated Geopolymer Alternatives to Portland Cement for Thermal Well Integrity. *{SPE} Thermal Well Integrity and Design Symposium*. <https://doi.org/10.2118/199787-ms>
- Vol'nov, I. I., & Petrocelli, A. W. (1966). Superoxides of the Alkali and Alkaline Earth Metals. In *Peroxides, Superoxides, and Ozonides of Alkali and Alkaline Earth Metals* (pp. 91–124). Springer {US}. https://doi.org/10.1007/978-1-4684-8252-2_5
- Vrålstad, T., Saasen, A., Fjær, E., Øia, T., Ytrehus, J. D., & Khalifeh, M. (2019). Plug & abandonment of offshore wells: Ensuring long-term well integrity and cost-efficiency. *Journal of Petroleum Science and Engineering*, 173, 478–491. <https://doi.org/10.1016/j.petrol.2018.10.049>
- Wedding, P. A., Manmohan, D., & Mehta, P. K. (1981). Influence of Pozzolanic, Slag, and Chemical Admixtures on Pore Size Distribution and Permeability of Hardened Cement Pastes. *Cement, Concrete and Aggregates*, 3(1), 63. <https://doi.org/10.1520/cca10203j>
- Weil, M., Dombrowski, K., & Buchwald, A. (2009). Life-cycle analysis of geopolymers. In *Geopolymers* (pp. 194–210). Elsevier. <https://doi.org/10.1533/9781845696382.2.194>
- White, C. E., Provis, J. L., Bloomer, B., Henson, N. J., & Page, K. (2013). In situ X-ray pair distribution function analysis of geopolymer gel nanostructure formation kinetics. *Physical Chemistry Chemical Physics*, 15(22), 8573. <https://doi.org/10.1039/c3cp44342f>
- White, C. E., Provis, J. L., Proffen, T., & van Deventer, J. S. J. (2011). Molecular mechanisms responsible for the structural changes occurring during geopolymerization: Multiscale simulation. *{AIChE} Journal*, 58(7), 2241–2253. <https://doi.org/10.1002/aic.12743>
- Xu, H., & van Deventer, J. S. J. (2003). Effect of Source Materials on Geopolymerization. *Industrial & Engineering Chemistry Research*, 42(8), 1698–1706. <https://doi.org/10.1021/ie0206958>

- Zhang, Y. J., Li, H. H., Wang, Y. C., & Xu, D. L. (2011). Geopolymer Microstructure and Hydration Mechanism of Alkali-Activated Fly Ash-Based Geopolymer. *Advanced Materials Research*, 374–377, 1481–1484. <https://doi.org/10.4028/www.scientific.net/amr.374-377.1481>
- Zheng, L., Wang, W., & Shi, Y. (2010). The effects of alkaline dosage and Si/Al ratio on the immobilization of heavy metals in municipal solid waste incineration fly ash-based geopolymer. *Chemosphere*, 79(6), 665–671. <https://doi.org/10.1016/j.chemosphere.2010.02.018>
- Zhu, H., & Yao, X. (2013). Effect of retarder on reaction process of metakaolin-slag-based geopolymer. *Journal of Theoretical and Applied Information Technology*, 48(3), 1384–1390.
- Zubrod, R. W. (2013). Performance-Based Specification for Geopolymer Cement Binders and Supporting Laboratory Data. In *Geopolymer Binder Systems* (pp. 165–184). {ASTM} International. <https://doi.org/10.1520/stp156620120061>
- Zuda, L., Pavlík, Z., Rovnaníková, P., Bayer, P., & Černý, R. (2006). Properties of Alkali Activated Aluminosilicate Material after Thermal Load. *International Journal of Thermophysics*, 27(4), 1250–1263. <https://doi.org/10.1007/s10765-006-0077-7>