



FACULTY OF SCIENCE AND TECHNOLOGY
BACHELOR THESIS

Study programme / specialisation: Mechanical engineering	The spring semester, 2022 Open / Confidential
Author: Mette Bjerga	
Course coordinator: Supervisor:	Ove Kjetil Mikkelsen Brigt Bjerga
Thesis title:	FishTrapSafe: From idea to finished product
Credits (ECTS): 20 ECTS	
Keywords: Fishing gear Product development Seawater Electrical components	Pages: 31 + appendix: 38 Stavanger, 14/05/2022 date/year

Acknowledgments

While writing this thesis, I have received a great deal of support.

I would start by thanking my external supervisor and father, Brigt Bjerga, for his extensive help in guiding a beginner in the ways of engineering. For answering every question with immense patience and taking the time to thoroughly explain concepts not easily understood. I also thank you for allowing me to create a bachelor's thesis from your idea.

I also want to thank my supervisor at the university, associate professor Ove Mikkelsen, for making himself available should the need arise, and for putting his faith in his students without excessive follow-ups.

In addition, I would like to thank Kenneth Langerud and Jarle Salte from Nexum Engineering for their help with understanding how to think like an engineer, and for their patience in guiding and answering every and all questions a new engineer might have, both related and unrelated to this paper. I would also like to express my deepest gratitude for borrowing of the Nexum workshop for the construction of the prototype.

I would also like to thank Stig Fjetland, for taking the time and giving valuable feedback on the prototype.

Last, I would like to thank my brother, Anders Bjerga, for proofreading my whole thesis, and giving me valuable advice on both writing and how to cite.

Abstract

During fishing activities, it is not uncommon that some of the equipment gets lost because of bad weather or bad luck during operations. However, an increasing problem faced by fishers is the loss of gear because of theft. Until recently, the fishing industry have had few satisfying solutions to prevent theft of equipment. The theft of either equipment or gear affects both the economy of the fishing industry and hobby fishers. In this work, a functioning prototype to prevent theft of equipment is proposed, as well as a discussion on additional functions and features that may increase its chances of reaching. In this work, a prototype to prevent theft of equipment is proposed, as well as a discussion on additional functions and features that may increase its chances of creating a successful product.

One way to prevent the theft of fishing gear is through an alarm system or a surveillance system. However, these solutions are not satisfactory for gear far from land. The solution presented here combines electrical and mechanical engineering in a physical prototype that is attached to fishing gear and sends an SMS to the owner when reaching target pressure, using a pressure switch to signal when it reached the specified pressure.

The solution proposed is a simplified prototype, comprising few functions. This was intentional, as the main goal of this paper was to finish the prototype, and it was therefore needed to contain manageable functions, to complete the prototype within the deadline. The prototype is intended to be further improved and has the main goal of reaching the market to be sold commercially. This is possible with the prototype created.

Table of Contents

1	Introduction.....	1
2	Product planning	2
2.1	Software	2
2.2	Hardware.....	3
2.3	Design of the container	5
2.4	Program.....	8
3	Construction	10
3.1	Connecting the SIM900 to Nano	10
3.2	Connecting the pressure switch to Nano	12
3.3	Connecting the battery to Nano.....	14
3.4	Creating the container.....	14
3.5	Assembly of the prototype.....	16
3.6	Challenges with the construction.....	18
4	Testing	19
4.1	Leak test	19
4.2	Final testing	21
4.3	Customer review	23
5	Economical	24
5.1	Product cost.....	24
5.2	Cost reduction	25
6	Discussion and further improvements	27
7	Conclusion	28
8	References.....	29
9	Appendices	31

Table of figures

Figure 2.1 Extension shield.....	3
Figure 2.2 SIM900 GSM/GPRS shield	3
Figure 2.3 Design of the container. Finished design (left) and cross-section (right).....	5
Figure 2.4 Finished design of the lid.....	6
Figure 2.5 Arduino program construction.....	8
Figure 2.6 Flowchart for program	9
Figure 3.1 Sim card holder.....	10
Figure 3.2 Hardware (left) or software (right) connection.....	11
Figure 3.3 SMD jumper.....	11
Figure 3.4 Nano to SIM900 connection.....	12
Figure 3.5 Connection between the switch and Nano	13
Figure 3.6 Workaround for pressure switch	13
Figure 3.7 Completed cycle	14
Figure 3.8 Finished 3D printed lid	15
Figure 3.9 Finished 3D printed container	15
Figure 3.10 Drilling (left) and filling (right)	16
Figure 3.11 Anti-static bag.....	16
Figure 3.12 Pressure switch screw	17
Figure 3.13 Finished lid.....	17
Figure 3.14 Finished constructed container.....	18
Figure 4.1 The bricks and the prototype	19
Figure 4.2 The container fully submerged.....	19
Figure 4.3 Container after testing	20
Figure 4.4 Gap between lid and container	20
Figure 4.5 Second test improvements.....	21
Figure 4.6 Extra protection for the content	22
Figure 4.7 Final test	22
Figure 5.1 Cost reduction with decreasing diameter	25
Figure 5.2 Machining costs decrease	26

1 Introduction

The ocean encompasses over 70% of the Earth's surface and is a key source of food as the land area available for farming is shrinking. The growing use of the ocean also causes economic incentives for crimes connected to fishing gear. The theft of fishing gear and/or the catch is difficult to prevent and stealing of the catch is even harder to detect. Because fishing gear range widely in price, the number of reported incidents involving theft is likely skewed towards more expensive gear. And even though there are few published reports on the statistics of fishing gear theft, it is probably relatively high. Besides the economic losses, a study from Oman suggests crimes associated with fishing gear may also lead to increased amounts of ghost fishing and lost gear [1], meaning that preventing theft is important to reducing the amount of waste that enters the ocean.

One way to address this problem is using galvanic time releasers, also known as pop-ups. These devices will allow for a buoy to be released after a specific time interval. This is a rather inexpensive solution but is a single-use only product, it is also not predictable, as it is based on corrosion, and a specific time it pops up cannot be determined. There is also the use of surveillance over the area where the traps are, though this can be time-demanding and expensive. It is also not possible if the fishing equipment is far from shore. An alternative approach is to take advantage of more than 60 years of Moore's law scaling that have resulted in electronic circuits which offer high complexity and small size at a low cost [2]. This allows for complex programming and storing of data to achieve a solution that is low in price and size.

The key innovation in our solution is the ability to make a product that is simple, cheap, durable, and low maintenance. Its intended purpose will be to alert the fishing gear owner that the fishing gear is raised above the water. This will give definite proof to the owner of the fishing gear that the equipment is retrieved by other than themselves. It comprises an electronic pressure switch that switches on when the water pressure reaches a specified pressure of 0.3 bar. When the fishing gear is submerged, it will reach pressures higher than 0.3 bar and the electrical signal will cut off. Once the pressure switch reaches above the intended pressure, the electronic signal will connect and activate an onboard GSM modem used to send a message to the owner of the fishing gear. The design of the device is waterproof and allows for simple and fail-proof attachment to the fishing gear. Ideally, this prototype is only the first step toward a more complex device. A device that can be further developed with GPS and additional sensors and more functionality. This will yield important data and additional market opportunities. This product is to be named FishTrapSafe.

2 Product planning

FishTrapSafe is a product that is composed of hardware and software. To develop a high-performing subsea device, the components must be encapsulated in a waterproof housing, and the program developed with regard that it does not get mobile service underwater. In the following sections, the reasons for choosing the different designs, hardware, and software are outlined. The cost is one of the main benchmarks for the chosen solution, as this product is aimed to be sold at a low price. The prototype will be limited to one concept that will be constructed and tested. For this study, the product planning process is determined by what functions need to be included and working step by step to find hardware that fits the functions.

The circuit cards were predetermined by supervisor but needed to be evaluated for their fit in this project, as that was not done beforehand. The circuit cards were chosen based only on compatibility and price. There is not a huge variety of different producers of circuit cards, and the ones that are the most used, reliable, and cheap are Raspberry Pi and Arduino-based cards. The Raspberry Pi contains a lot of features that are not required for this project, and it is not as flexible as Arduino when it comes to the size of hardware. Another important aspect is that Raspberry Pi is categorized as a self-contained computer, whereas Arduino is just a microcontroller with not as much processing power. The solution proposed here does not require a lot of processing power.

2.1 Software

As part of the hardware was already chosen, the software choices were limited. For this project, the obvious software was Arduino IDE. An IDE is an environment or program that is used to write the code that forms the program. A quick search on Arduino shows that there are thousands of projects done with Arduino. Kondaveeti et al. [3] point out that: «Arduino, an open-source electronics platform, has become the go-to option for anyone working on interactive hardware and software projects.”. Its predecessor Wiring (prototype platform), was created by Hernando Barragán when he was a student, with the intent of making the creation of digital tools available and easy for everyone [4]. Following this, the creation of Arduino was based on the idea of making the technology even more accessible and affordable for hobbyists and academia, as well as complex enough for the professionals [3, 4]. Arduino offers a wide range of different circuit boards of different sizes and comes at affordable prices. Arduino is easy for beginners and does not require much effort to understand the logic it operates with if the user has some basic understanding of programming. If encountered with problems, there is a huge community of Arduino users, who are happy to work together to find a solution.

It would also be possible to create the program in Python, using a different program called OpenMV IDE. This was also considered, as Python was already a known syntax, and would not need time to learn how to code within a new environment. The problem with using python is that it can make the code slow to run [5, p. 9]. This is, however, not a major problem for programming the prototype but can provide a too slow runtime and a need to program in another language in the long run. To eliminate this and create a challenge combined with a desire to learn a new environment and syntax, it was chosen to proceed with the Arduino IDE. There are also only some specific versions of the Nano that are compatible with the OpenMV IDE, and those are more expensive than the ones running on only Arduino IDE.

2.2 Hardware

The microcontroller is the brain of the system and controls where and when the electrical signals will be sent. The Arduino IDE sketch that is written will be uploaded onto the microcontroller. Arduino has a wide range of boards available, with Uno being the most popular. Two microcontroller attributes are especially important for this product: size and price. Uno is defined as a medium-ranged board, while the Nano is practically a mini version of Uno [3]. Its size is approximately one-third of the size of Uno, with dimensions of 18x45 mm and the smallest of Arduino boards [6]. It is also cheaper. The main weakness of using Nano with this type of set-up is the low number of other similar projects done using Nano, as it is more popular to use Uno. Even though Nano can be used the same way as Uno in most aspects and should create only minor inconveniences, if any at all. The creators of the Arduino platform have made all its hardware open source, which have created even cheaper copies or derivatives than the original Arduino boards. Though, the cheaper boards can introduce more problems to work around than an original Arduino. To create an option to use an external power source, an extension board is used with the Nano, as shown in figure 2.1, as the Nano itself can only be powered using a USB connection. The size of the Nano with the shield, is approximately the same size as the Uno, and the only difference would be a small increase in price and size if Uno was chosen.

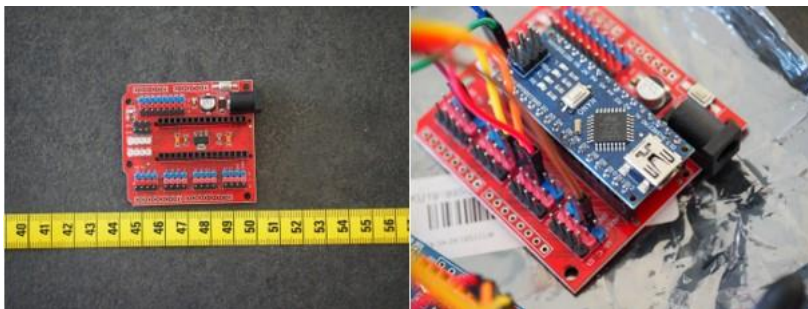

Figure 2.1 Extension shield

The Arduino circuit boards provide the flexibility of extending the functions of the circuit board, using shields. Shields are a type of circuit extension board with an intended function, such as a Bluetooth shield or Wi-Fi shield. It works on both Arduino and Arduino derivatives. One of the main functions of the prototype is to send an SMS message, meaning that the Nano needs a shield to get that function. There is a specific shield intended for this purpose, the SIM900 GSM/GPRS shield for Arduino, shown in figure 2.2. This shield can connect to the 2G network to send SMS. It is important to note that the

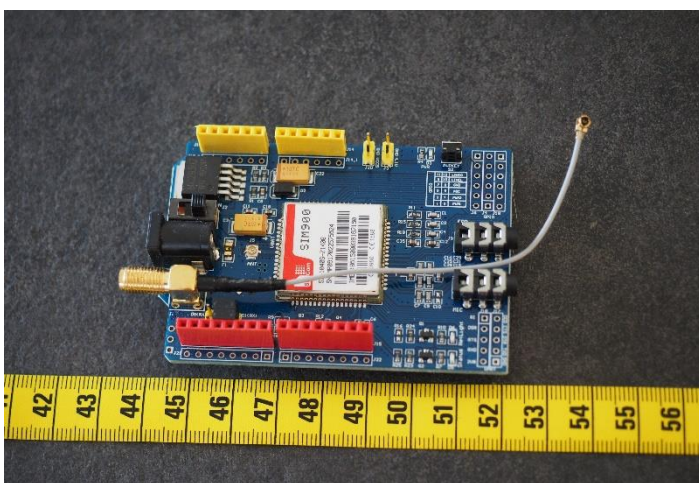

Figure 2.2 SIM900 GSM/GPRS shield

2G network is planned to be shut down in Norway (some countries have already shut it down), but this is not scheduled before 2025 [7]. Within the software, there are libraries for the SIM900 shield functions. Had the SIM900 not already been predetermined, another card might have been chosen, e.g., the SIM900A, as this would decrease the size. The SIM900A would, however, increase the cost slightly and would not come with a power jack.

Another key function of the prototype is the ability to detect when it reaches the surface. One option is a pressure sensor. But, as the prototype does not need to read and act on different pressures, another cheaper and less complex option would be a pressure switch. The pressure switch needs to switch on at low pressures, as the intended pressure area will be just within the surface, at around 0.1 bar. It is important to note that the pressure switch will have a starting pressure at one atmosphere (approx. one bar), so a range within 0.1 to 1 bar is viable. One bar would then be around ten meters below the surface. The switch can be adjusted to switch on when reaching the desired bar.

Designing equipment for use in seawater is often challenging because of the harsh and corrosive conditions. The switch would need to be specifically designed for operating in a seawater environment, and since the switch needs to be extremely precise, it will be expensive. An additional solution that was evaluated was to make the SIM900 shield continuously try connecting to a network, which would not work underwater. SIM900 is, however, known for consuming much power [8], unless idle, which it will not be if searching for a network connection. It is not a viable solution if trying to reduce the size as much as possible, as more power consumption equals bigger battery capacity. It would, however, cut down the cost, as a bigger battery is likely cheaper than the pressure switch. The option of a pressure switch seems the most viable option, but it will be evaluated again when deciding on battery size. For the solution of a pressure switch, a switch from Suco, provided by Witec Hydraulics, with a G ¼ thread size with a range between 0.1-1.0 bar is considered the most viable option [9]. This has a tolerance of ±0.2 bar, which will not affect its use in this project. This tolerance is however the reason 0.3 bars must be the target pressure, as 0.2 bars could cause the pressure switch not switching when above water.

When deciding on the energy solution, the solution could be a battery that may provide power for at least one week without needing to be charged. The Arduino Nano draws 0.2mA when active [10]. The SIM900 on the other hand, can draw up to a maximum of 2000mA at peak performance, and almost 500mA in bursts when connected to a network [8]. It is, however, not easy to estimate how much it will draw, as the card would only draw power for short periods continuously. It is possible to embed into the program that the microcontroller puts itself in power-down mode for a certain number of seconds before waking up again and continuing running the program, to keep the power consumption to a minimum. This means that it will only be active for short periods, assuming around one second to check if the switch has turned on. While it is powered down, it uses < 0.5 µA, and is assumed to be negligible. It needs to be considered that it will drain much more for shorter periods when the crab pot is hoisted up perhaps several times in one week. The most viable method to determine this would be to run a test with a fully charged battery, measuring the current with an ammeter and letting it run out, timing the number of hours. As stated previously, it was challenging to find exact data on how much consumption both the SIM900 and Nano have on average in one hour or a day. An approximation found for the SIM900 was used to calculate the minimum battery capacity if the SIM900 would run continuously trying to connect to a network, as this could also be a solution. Requiring about 500 mA per day if fully operational [11], where the SIM900 would continuously try to connect to a network, it would require at least:

$$mAh\ needed = 7\ days * 500mAh/day = 3533.6\ mAh$$

(2.1)

Equation 2.1 shows the amount of mAh needed for just the SIM900 to continuously search for network. It could also cause the battery to create a lot of heat if requiring much power continuously, which is not wanted. Therefore, the solution of the pressure switch is the most viable. A 2200 mAh

battery was chosen from Elefun, as it was one of the most affordable found [12]. This battery should be able to handle the burst periods of the SIM900 and the active periods of the Nano. Whether it will hold for a week or more needs to be further tested. This is a battery that is intended mostly for drones, which makes it compact and small, and powerful enough so that both the circuit cards can draw the required amount of power.

2.3 Design of the container

Crab pots and fishing gear vary in size, and as the product is intended as a type of universal product, the size of the container needs to be in compared to the smallest crab pot. For this study, the dimensions used are 650 mm in length, 350 mm wide, and 380 mm in height, which is defined as a small crab pot [13]. The design comprises two objects, the container, and the lid. The first design element is the shape, as both rectangular and circular shape is possible, but the area and volume of the container will be larger with a rectangular shape. It will also be more complex to attach a rectangular shape to the pot and can be more challenging to keep waterproof. With a circular shape, it is possible to use something as easy as plastic strips. The container needs to be big enough that the content can be fitted into the shape, and it should be no problem with a circular, even though the rectangular offers more space. For this prototype, the design is big, and it is possible to decrease its size. The size was chosen to be certain that all the components would fit comfortably and to not have to work in too tight spaces. The size of the SIM900 and Nano was used as a reference. The SIM900 is 90mmx70mm, not accounting for the separate antenna that needs to be connected. To create enough leeway, a simple 3D model of the SIM900 and antenna was created, along with the Nano, including the extension, where the sizes were bigger than in real life, to account for extra room and give space for the battery. The circular diameters were then adjusted accordingly using the cross-section view in figure 2.3, giving an outer diameter of 160 mm and an inner diameter of 120 mm. Figure 2.3 also shows the intended attachment method to the crab pot, using plastic strips, which are the two tracks on the outside. The total length of the prototype was set to 200 mm. To keep the price as low as possible, and since the container would not need to withstand high amounts of pressure, a plastic material of the type of POM-C [14], would be used. This is widely used in the offshore section and can withstand the environment subsea. It is also readily available and lightweight. One of its colors is black, which is a good fit with trying to keep it as invisible as possible subsea.

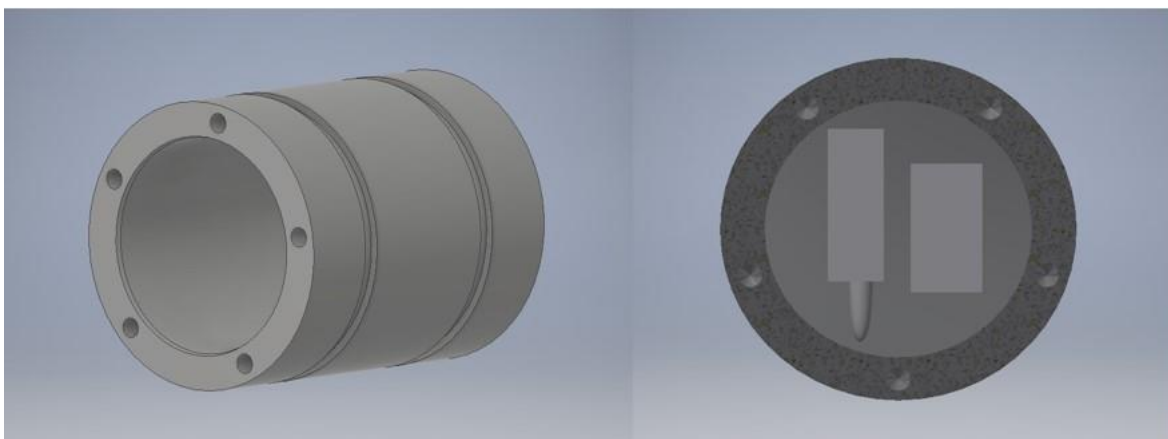

Figure 2.3 Design of the container. Finished design (left) and cross-section (right)

The lid itself is most suited to contain a hole for the pressure switch, which will make the most sense to be placed in the center. It also needs to allow for bolts, so that the lid itself is pressed down. It would not need bolts that can withstand high stress or have high tensile strength, as the external

pressure of the water would help the bolts keep the lid on. Plastic is prone to thread break if the thread is directly machined into it. Therefore, thread inserts are needed, and this will be accounted for in the holes in the container. These will then be machined as free holes. It is assessed that a standard M8 bolt is enough, as it is very easy to get a hold on, and the lid does not need an extensive amount of clamping force to hold. It may be possible to use an M6 bolt instead, but for plastic, it is preferable to be more on the safe side and M8 provides a bigger area of contact than M6. The bolts should be of type 316 stainless steel, as these are good enough to withstand corrosion in saltwater [15], i.e., quality A4 which is used for bolts. As there is no internal pressure, it is unnecessary to calculate how many bolts are needed, and it is assessed that five bolts are enough. To ensure that the container is waterproof, an O-ring pattern needs to be added to the lid. The lid is designed to be a clearance fit, with the tolerance of H8/f7 on the hole in the container. This fit is recommended for a piston-like design with an O-ring. This was determined by using a precision O-ring catalog [16], with the diameter of the O-ring at 3.53 mm, and the diameter of the O-ring track at 113.6 mm. The finished design of the lid is shown in the figure 2.4. The technical drawings of the two parts can be found in appendix B and C.

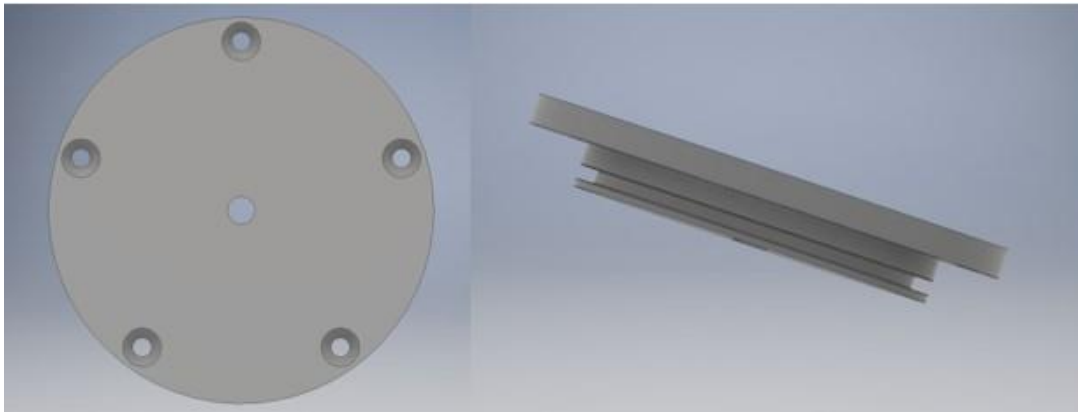

Figure 2.4 Finished design of the lid

The aim was a product that could withstand water pressure down to 200 meters depth. This depth threshold would enable the product for king crab fishing as well, which is performed at a little less than 200 meters depth. To be sure that the POM-C can withstand that pressure, calculations are needed for theoretical verification. As a container is immersed in water, it will experience pressure acting in all directions on its body. To calculate the absolute pressure subsea at 200 meters, the following formula is used:

$P_{subsea} = P_{atm} + \rho gh$, where ρ is the density of the substance, g is the gravitational force, and h is the depth.

The density of seawater is affected by the substances dissolved in the area and ranges from about 1020 kg/m^3 to 1030 kg/m^3 [17]. The difference is negligible, and the highest number is used. The gravity is also different depending on where on the earth it is measured, but this difference is also negligible. The gravitational value is set to be 9.81 m/s^2 . The depth of the water is predetermined to be 200 meters. The atmospheric pressure is $101\,325 \text{ Pa (N/m}^2)$. It is arguably permitted to not account for the atmospheric pressure, as there will be an almost equal pressure inside the container as the atmospheric pressure, which would cancel each other out. It is decided that it is added, as it is a negligible difference, and it provides a bit of safety on the pressure on the vessel.

$$P_{subsea} = 101\,325\text{ Pa} + 1030 \frac{\text{kg}}{\text{m}^3} * 9.81 \frac{\text{m}}{\text{s}^2} * 200\text{ m} = 2122185\text{ Pa} \cong 2.12\text{ MPa} \quad (2.2)$$

The wall thickness and geometry must be considered when assessing if the wall thickness is big enough to withstand the absolute pressure at 200 meters depth. The first step is to determine if the pressure vessel is thin-walled or thick-walled, which can be done by using the general rule of thumb: $t \leq 1/10 * D_m$ for thin-walled (D_m being the external diameter and t being the wall thickness) [18].

$$t \leq \frac{1}{10} * 160 = 16 \rightarrow \text{Thick walled cylinder as the thickness is 20mm}$$

To calculate the pressure the cylinder can withstand, Lamè's equations are used, which are given in equation 2.3, as the cylinder is thick-walled [19]. Lamè's equations are a set of equations that gives the stresses in three directions: hoop stress, which is the stress the cylindrical wall obtains from the pressure difference, axial stress is the stress the wall receives parallel to the centerline, and radial stress is the stress perpendicular to the centerline. It is assumed that the vessel is only experiencing external pressure, meaning $P_i = 0$. As the only pressure acting on the container is hydrostatic, the hoop and radial stress will be the same within the whole cross-section, but both are calculated to show this, and can be used to check that the calculations are correct.

$$\sigma_{\theta} = \frac{-P_o r_o^2}{r_o^2 - r_i^2} \left[1 + \frac{r_i^2}{r^2} \right] \quad | \quad \sigma_r = \frac{-P_o r_o^2}{r_o^2 - r_i^2} \left[1 - \frac{r_i^2}{r^2} \right] \quad | \quad \sigma_z = \frac{-P_o r_o^2}{r_o^2 - r_i^2} \quad (2.3)$$

σ_{θ} is the hoop stress, σ_r is the radial stress and σ_z is the axial stress

For $r = r_i$:

$$\sigma_{\theta} = \left[\frac{-2P_o r_o^2}{r_o^2 - r_i^2} \right] \quad | \quad \sigma_r = 0 \quad | \quad \sigma_z = \frac{-P_o r_o^2}{r_o^2 - r_i^2}$$

$$\sigma_{\theta} = \left[\frac{-2 * P * 80\text{mm}^2}{80\text{mm}^2 - 60\text{mm}^2} \right] = -4.57P \quad | \quad \sigma_r = 0 \quad | \quad \sigma_z = \frac{-P * 80\text{mm}^2}{80\text{mm}^2 - 60\text{mm}^2} = -2.29P \quad (2.4)$$

For $r = r_o$:

$$\sigma_{\theta} = -P_o \left[\frac{r_o^2 + r_i^2}{r_o^2 - r_i^2} \right] \quad | \quad \sigma_r = -P_o \quad | \quad \sigma_z = \frac{-P_o r_o^2}{r_o^2 - r_i^2}$$

$$\sigma_{\theta} = -P * \left[\frac{80\text{mm}^2 + 60\text{mm}^2}{80\text{mm}^2 - 60\text{mm}^2} \right] = -3.57P \quad | \quad \sigma_r = -P \quad | \quad \sigma_z = \frac{-P * 80^2}{80\text{mm}^2 - 60\text{mm}^2} = -2.29P \quad (2.5)$$

For equation 2.4 and 2.5, the same σ_{max} is obtained, as the difference between r_o and r_i is $1P$, which is seen in the σ_{θ} , where the difference is 1. To find the equivalent stress, or in other words, the maximum stress, equation 2.6 [20] is used:

$$\sigma_{max} = \sqrt{\frac{1}{2} (\sigma_r - \sigma_{\theta})^2 + (\sigma_{\theta} - \sigma_z)^2 + (\sigma_z - \sigma_r)^2}$$

$$\sigma_{max} = \sqrt{\frac{1}{2} ((-(-4.57P))^2 + (-4.57P - 2.29P)^2 + (-2.29P)^2)} = 6.05P \quad (2.6)$$

To find the pressure at yield using the values from the POM-C datasheet from Vink Norway AS [14], the following yield criteria for von Mises are used:

$$\sigma_{max} = \sigma_y \rightarrow P_{at\ yield} = \frac{66}{6.05} = 10.91\ MPa \quad (2.7)$$

Equation 2.7 shows that the maximum pressure is well above the absolute pressure the container is experiencing calculated in equation 2.2 and gives a safety factor of 4.96. This gives room to be able to decrease the size, as the thickness of the wall can be reduced.

2.4 Program

The program needs to be able to use the pressure switch to check if it is over or below certain pressure. If it is over, it will start the SIM900 and check for a connection before it sends the text. This will be done using loops. Looping a function is an ideal method in programming for running a program an unlimited number of times, without a need to restart the microcontroller. It is also how programs in the Arduino IDE are constructed, containing a setup function that only runs once, and a loop function that runs repeatedly as shown in figure 2.5. Figure 2.5 also shows how a new sketch looks when a user creates one in the Arduino IDE. It is also possible to create other functions, which are needed for the optimal functioning of this program.

```
void setup() {
  // put your setup code here, to run once:
}

void loop() {
  // put your main code here, to run repeatedly:
}
```

Figure 2.5 Arduino program construction

The program must contain a logic that only sends the text once, as it is not preferable to continuously send messages while the pressure switch is active. The program will follow the logic given in the figure 2.6. Preferably, it should contain a solution for putting the microcontroller to sleep and using an interrupt function to wake it up. This would be ideal for saving power and keeping the battery lasting longer, as the microcontroller uses very little power when in power-down mode.

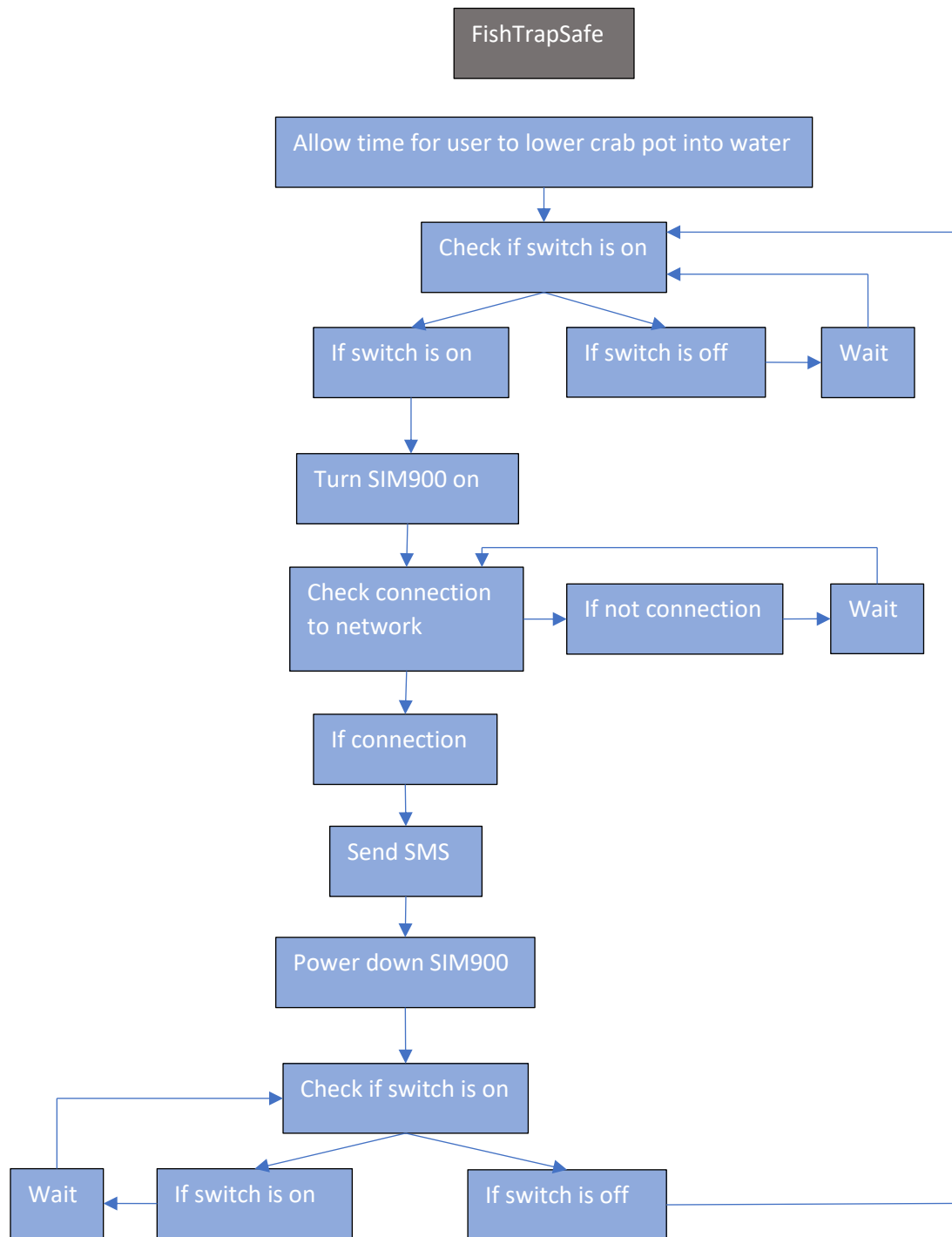

Figure 2.6 Flowchart for program

3 Construction

The first step of the construction was to connect the electrical components of the prototype. Parallel with connecting the electrical components, the development, and testing of the program for the software is executed. The basic code for sending the text and connecting the SIM900 to the Nano was found on Last Minute Engineers [8], as well as how to power up the SIM900 from software. The code was then adjusted to fit the exact functions that were needed for this project. The first program test was done right after the Nano and SIM900 were connected, before moving on with the function for waking up the SIM900 from software. The next step was to connect the pressure switch to the microcontroller and test if that worked. Then the battery was connected and checked if functional, and the code was again tested with the battery as a power source. The container was then created and made ready for complete construction. The last step was the complete construction of adding the content to the container.

The complete software code is shown in appendix A, and the reason for each function is described. A simple circuit diagram showing the connections are shown in appendix E, while appendix F contains the part list for this construction. The next section describes the detailed procedures and methods used in the construction.

3.1 Connecting the SIM900 to Nano

There are two options for connecting SIM900 to Nano, hardware serial or software serial. For this project, software serial was chosen, as hardware serial connection can provide problems when trying to communicate with a computer, which could cause problems every time there needed to be an adjusted code sent to the Nano from the computer. The program was tested using a function in the Arduino IDE called a serial monitor. This function allows the user to receive messages from the Arduino board. It is by this function possible to test the connection between the Nano and SIM900. The first step was to insert a prepaid SIM card shown in figure 3.1, which had disabled the pin code, as it makes it easier to program.

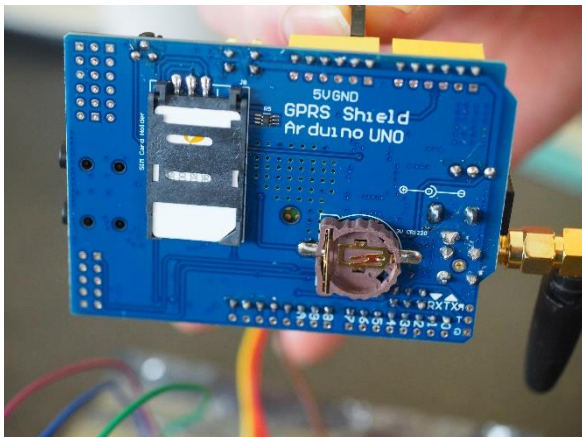

Figure 3.1 Sim card holder

A jumper cable allows the user to switch between hardware and software communication, and this was moved to the correct connection as shown in figure 3.2, where the left side has the hardware communication chosen, and the right side the software communication. The SIM900 comes with hardware communication as the standard choice.

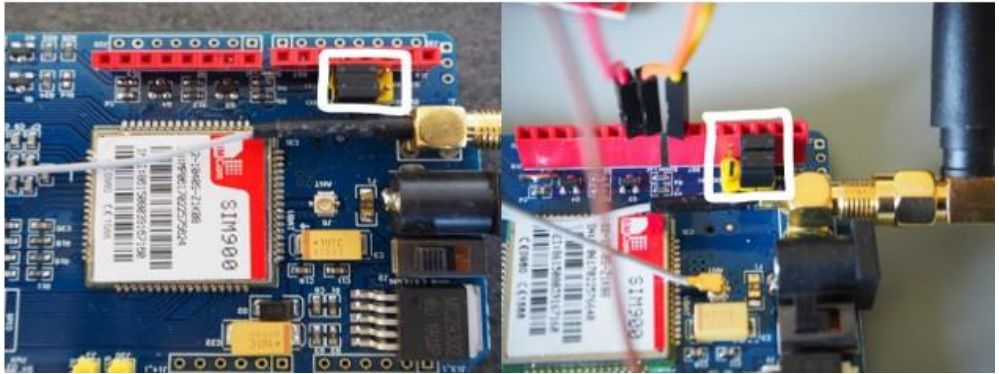

Figure 3.2 Hardware (left) or software (right) connection

For the SIM900 to be started using software, an SMD jumper needed to be soldered on the SIM900. An SMD jumper is a connection on the circuit board that is inactive, and the jumper needs to be connected by soldering to be active. Figure 3.3 shows the jumper inactive (to the left) and soldered and active (to the right).

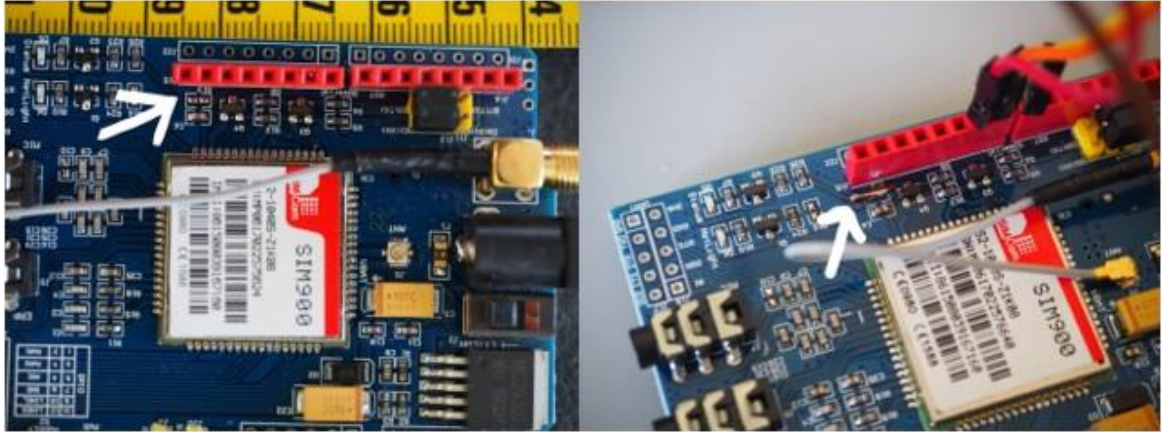

Figure 3.3 SMD jumper

For the AltSoftSerial library, which is used in this project, pins 8 and 9 on the Nano have to be receiver and transmitter, respectively [21]. The pins that are connected needs to be defined in the program. These were connected to the software TX and RX connections on the SIM900. TX stands for transmitter pin and RX stands for the receiver pin. It is also important that the GRD (ground) on the SIM900 is connected to the GRD on the Nano to prevent a short circuit from damaging the board.

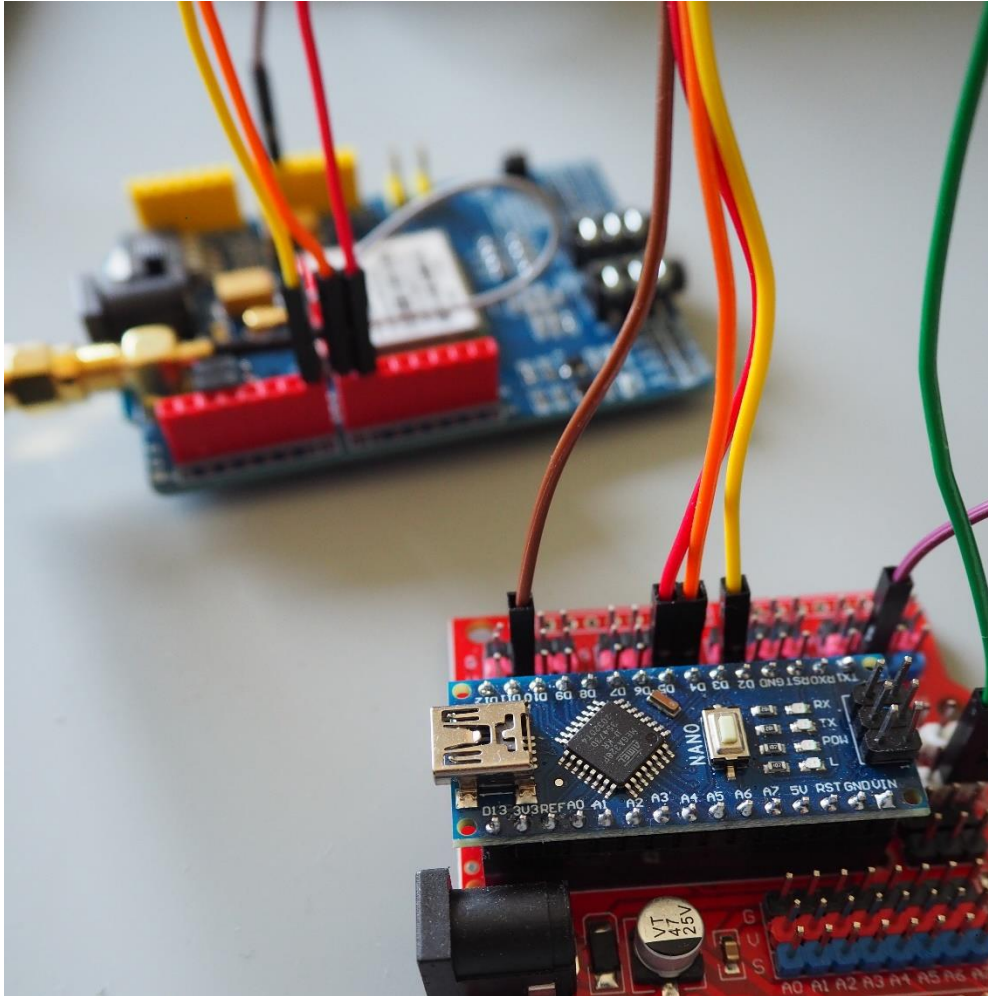

Figure 3.4 Nano to SIM900 connection

In figure 3.4 the connections from the Nano to the SIM900 are shown. The brown wire is connected to the SIM900 ground. The red wire is connected from pin 10 on Nano to pin 9 on SIM900. The orange wire, which is the TX (output) pin on the Nano is connected to the RX (receiver) pin on SIM900, and reverse for the yellow wire, where RX on Nano is connected to the TX of the SIM900. This connection is also specified in the program, where the serial communication pins are chosen as 8 and 9 on the Nano, giving these the specification of RX and TX, respectively.

3.2 Connecting the pressure switch to Nano

The pressure switch comes with one input and one output connection. The problem with using a switch is that the connection is completing the electronic circle or not. This means that when it is not a complete circle with no feedback to the input provided, the input pin on the Nano will get a floating input, meaning that it can either be high or low. This is randomized and not possible to predict [22]. As a workaround, the connection needs to be given a low voltage when not active, to always give the input connection the variable “LOW” when the pressure switch is off. This is done by having a second connection on the input pin on the Nano. This connection is using the ground voltage, running it through a resistor (in this case 1K Ω), and into the input pin, to create a low input when the switch is off [23]. This was initially done using a breadboard and a regular switch to test the program before having the pressure switch connected, to make sure that it was operational. Figure 3.5 shows the connections between the switch and breadboard.

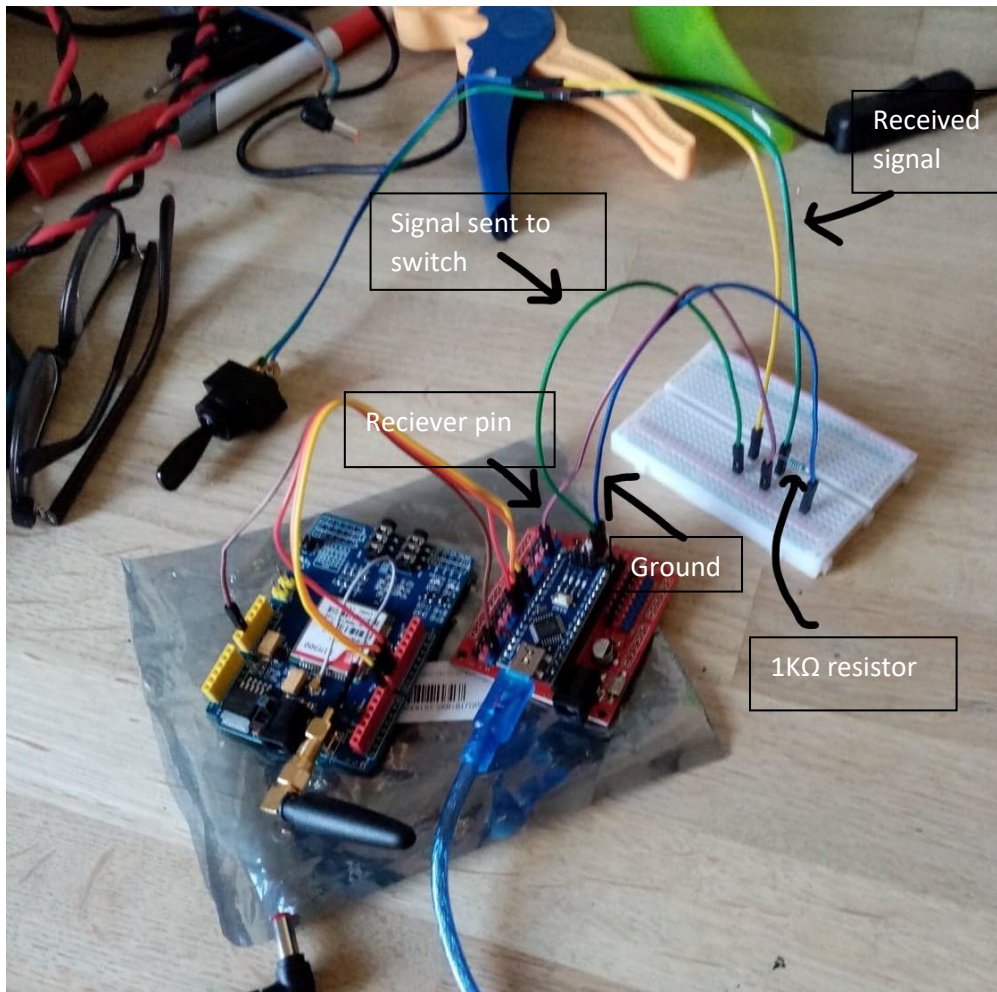
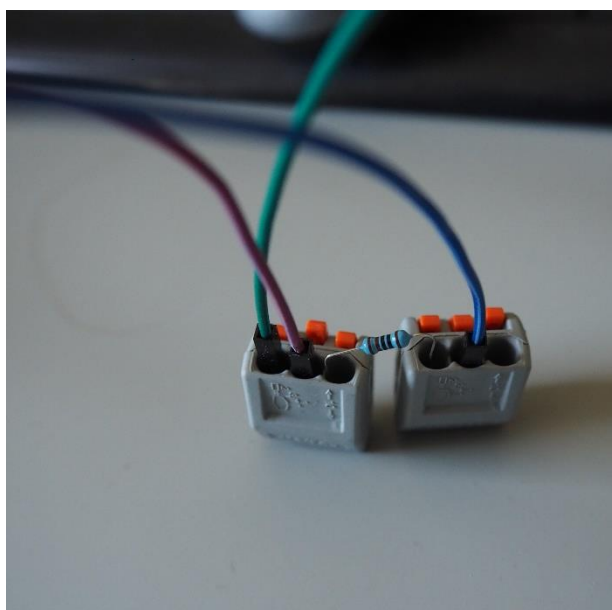

Figure 3.5 Connection between the switch and Nano

To manage this without a breadboard, as this would increase the space needed, electrical connectors were used to create a workaround, as shown in the figure 3.6.



Here, the pressure switch receiver signal (green wire) is connected to the one on the left, and the same one has a further connection to Nano (purple wire). Between them is the resistor, and the one on the left has a connection to the GRD on the Nano (blue wire). This ensures that the input pin 2 on the Nano, which is where the purple wire is connected, always receives either the value “LOW” from the GRD output through the resistor or “HIGH” from the connected pressure switch when it is switched on. This was then tested using the regular switch, as it would behave the same as a pressure switch.

Figure 3.6 Workaround for pressure switch

3.3 Connecting the battery to Nano

The battery outlet would need to be separated into two plugs, as the same battery would be used for both circuit boards. As shown in figure 3.7, the same solution as with the pressure switch is chosen, using electrical connectors. It was important to connect the right way, or the worst-case scenario could be the development of fire. This is done by picturing the electrical circuit as a circle, wherefrom the battery will be drawn from the negative pole towards the positive pole, where it can have several consumers (devices that draw electricity) along the way. For SIM900 the center-pin is the positive node, while the outer area is the negative node [24, p. 160-161]. It was assumed it was the same for the Nano extension shield as well. To figure out which of the pins on the plugs was connected to the outside or inside, the documentation of the plugs can be used. Here, the documentation was lost, and an ohmmeter was used instead. The ohmmeter would give a 0-value when there was a connection, and no value when there was no connection, showing which pin was connected to the outside of the plug. The positive and negative inlet and outlet were engraved on the battery, which can be seen in figure 3.7. Then it was only a matter of connecting the negative from the battery to the negative of the plugs, and the positive from the plugs to the positive of the battery, completing the cycle.

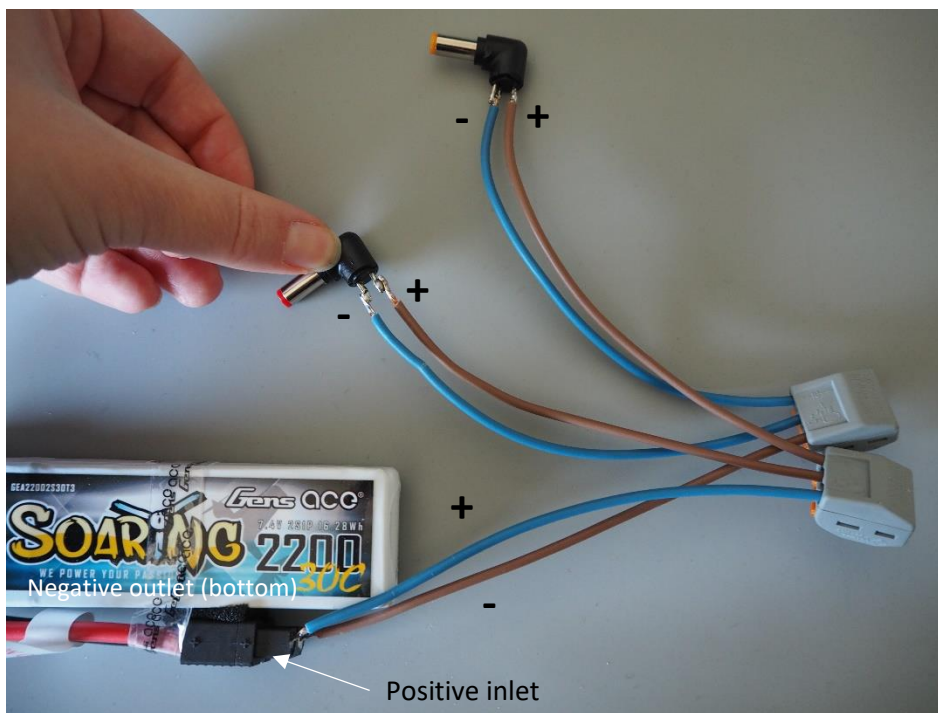

Figure 3.7 Completed cycle

3.4 Creating the container

The first plan was to get the container machined, but as this is only a prototype, the external supervisor wanted a different approach to keep costs down, as machining only one was expensive. The university of Stavanger has several 3D printers available for use. This option was the most fitting, as it came with no costs and readily available. This was, however, extremely time demanding as the container took around 60 hours (due to its size) and the lid 12 hours. The 3D printing was also done without a lot of filling, meaning that the parts could not withstand a lot of pressure before failure, but should provide enough strength for testing. Finished 3D prints of the prototype are shown in figure 3.8 which shows the lid and figure 3.9 showing the container. There were added supports on

the lid, which is the green that obscures the O-ring pattern on the left side of the picture and one of the bolt holes on the one on the right. The supports were removed.



Figure 3.8 Finished 3D printed lid



Figure 3.9 Finished 3D printed container

The final product is still thought to be produced with POM-C, but it was not essential for the prototype to be in this material. The 3D printer is not precise enough in creating the G $\frac{1}{4}$ thread the pressure switch needs or the circular clearance fit as the STL-file breaks the 3D model into a mesh containing only polygonal shapes [25, 26], which can be seen in figure 3.9. The 3D printing of the lid was therefore without the threaded hole and was drilled afterward as shown in the figure 3.10. As the print was done without a lot of filling, most of the space inside was hollow. The hollow space could not support threads, and the hole was therefore filled with epoxy, which is a type of plastic filling, also shown in figure 3.10. To create the threads needed for the G $\frac{1}{4}$ pressure switch, a new hole was drilled within the plastic filling, and a tap drill was used to create the desired thread. To find how large the hole should be drilled, a conversion table was used, giving the measurement 11.8 mm

for a G ¼ thread. The hole should be slightly bigger rather than smaller, and a 12 mm drill was used for the hole, and then a tap drill for G ¼ threads was used.

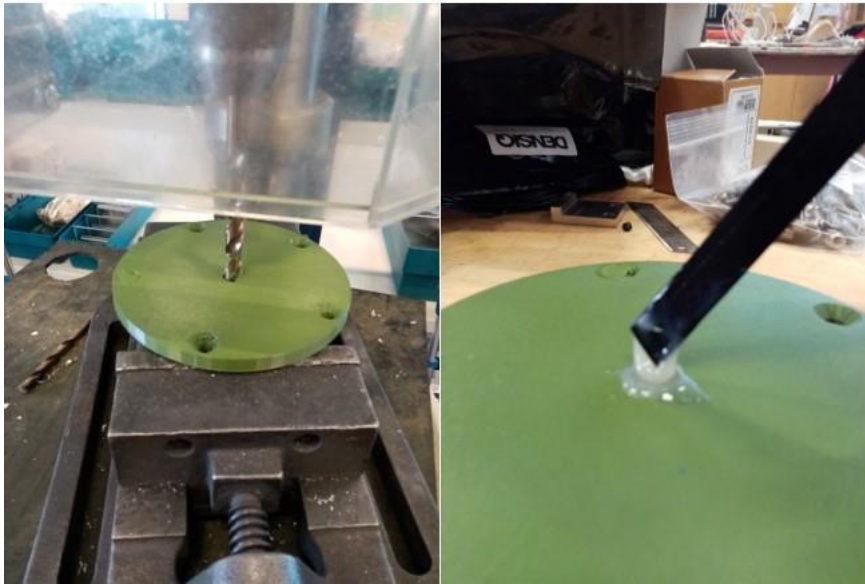

Figure 3.10 Drilling (left) and filling (right)

3.5 Assembly of the prototype

To create some separation, and air between the circuit cards and battery, a separator needed to be installed. Both plastic and wood were evaluated. The cheapest option would be wood, as it is possible to find a left-over piece, and saw it into a plate that can be used for this prototype. It was needed to add a kind of anti-static film to protect the circuit cards from being static damage, and to avoid short circuit between the cards and connections. The safest way to do this would be to pack both in anti-static bags. This is the same type of bags the circuit cards are transported in, to minimize the risk of static damage. The circuit cards in the anti-static bag are shown in the figure 3.11.



Figure 3.11 Anti-static bag

The pressure switch needed to be attached to the lid using the threads already made. To be sure that there was no leakage of water within the threads, a thread sealant 5S77 from Hydroscand was used. This both seals the area between the pressure switch and the threads and fastens the hold on the pressure switch. This was supplied in generous amounts on the threads of the pressure switch before inserting it into the hole. The switch point needed to be set on the pressure switch, which is set by the screw in the figure 3.12. To successfully set the switch point, a test pressure gauge is needed. This was not done in this paper, as it was not necessary to have it exactly.



Figure 3.12 Pressure switch screw

The O-ring was created using just a cord of O-ring with a diameter of 3.5 mm, measuring it in the pattern, and then making it around a centimeter smaller before cutting it. When cutting it, it needed to be a straight cut, as the two ends of the strip would then be glued together to form the complete O-ring. The O-ring then needed to be greased, before inserting it into the pattern intended for it. Figure 3.13 shows the finished assembled lid.



Figure 3.13 Finished lid

The container needed to have the inserts added. This was done using an M8 bolt with the thread insert on and screwing it down into the hole. The bolts with the thread inserts, as well as the container with the thread inserts are shown in figure 3.14.



Figure 3.14 Finished constructed container

3.6 Challenges with the construction

Most of the challenges faced occurred within the development of the software, as the software needed to be learned as it was developed. At first, problems connecting the Nano to the computer and uploading the program were not working. After trying to troubleshoot the error for a long time, it was discovered that it would only upload the code correctly if the computer had been freshly restarted. The reason behind this issue is still not understood, but the error was probably within the Nano circuit card itself. This proved very troublesome, especially when testing, which often requires a new modified program to be uploaded. This was resolved by switching to another Nano. The first function developed and tested was the sending of the SMS. The projects that included SIM900, used the Arduino Uno instead of Nano. The communication of SIM900 with Uno is done at a baud rate of 9600bps, and the significance of the baud rate was underestimated, it had Auto-Baud detection on the circuit card. Probably, the Nano copy that was used for this prototype did not have that, or it works in a different way than assumed. For the Nano card used, the communication needed to be at 115200bps, which is the highest possible baud rate for the SIM900.

The interrupt function was attempted to be created but did not work. It is possible that the interrupt function was not fully understood. Therefore, a library to use a function to put the microcontroller to sleep for four seconds at a time was used instead.

The SMD jumper on the SIM900 provided a bit of a challenge and a ruined SIM900 board. This jumper is quite small, and being a beginner level in soldering, resulted in destroying the jumper. The board remained functional but powering up the module by software is critical for the battery size selected. Soldering tips were also studied, to be able to enhance skills before trying again.

Finally, the precision and resolution of the 3D printer were not high enough to enable a perfect fit between the lid and the container. The lid was therefore filed down using a standard half-round file with middle roughness, to where the lid slid down the container without exerting a great deal of force. Because of these challenges, the assembly of the prototype took longer than expected. The first filling was unsuccessful, and it needed a second filling, which needed to dry for two days in between.

4 Testing

One of the main challenges with having electric equipment in containers that are submerged in water is making sure the container is waterproof. One concern regarding the 3D printed prototype is that the plastic used to print is not fully waterproof or the 3D printing is not dense enough. Therefore, a water leakage test was performed before conducting a full test where the electric content is added. The testing was accomplished in cooperation with the external supervisor.

4.1 Leak test

This was done by adding bricks to the container, fastening the lid, and submerging the container in seawater. The bricks were added to increase the weight enough for it to sink, and it needed three bricks before submerging the prototype, as the buoyancy effect of the plastic was higher than expected. The bricks connected to the prototype are shown in the figure 4.1. Figure 4.2 shows the container fully submerged in water at around three to four meters depth. The container was then left for 25 minutes, and then checked for any moisture or water.

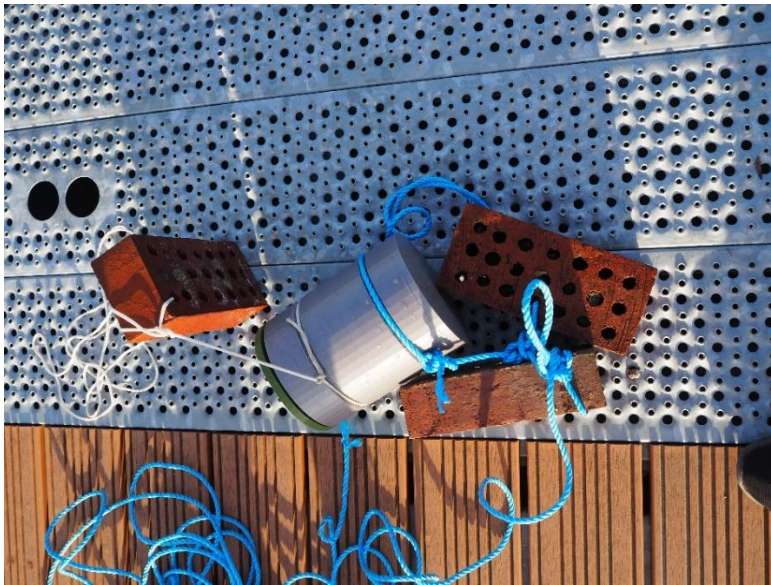

Figure 4.1 The bricks and the prototype



Figure 4.2 The container fully submerged

Unfortunately, this was not waterproof, where figure 4.3 shows the amount of water in the container.

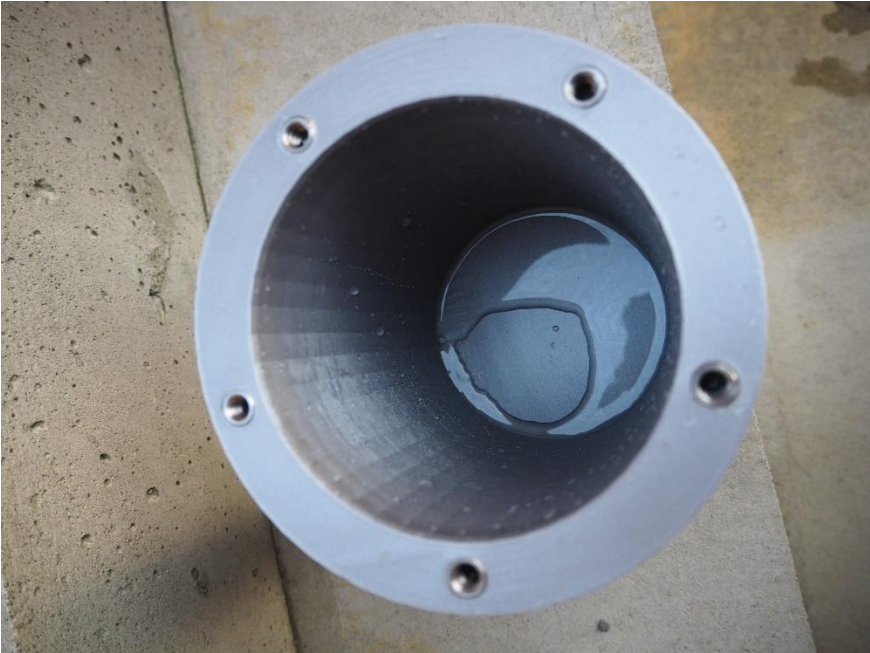

Figure 4.3 Container after testing

This was a problem, as the full test could not be conducted before demonstrating that it was waterproof. It was difficult to predict where the water was leaking in from, but the lid was not able to properly get screwed down, as shown in the figure 4.4. This was evaluated as not a problem before conducting the water leakage test, as the O-ring was below. The O-ring was probably a bit too big for the track for it, and the plastic was not ductile enough, causing the O-ring to not be completely pressed down. This could be the source of the leak but might also be caused by the 3D printed material not being dense enough to prevent water penetrating.

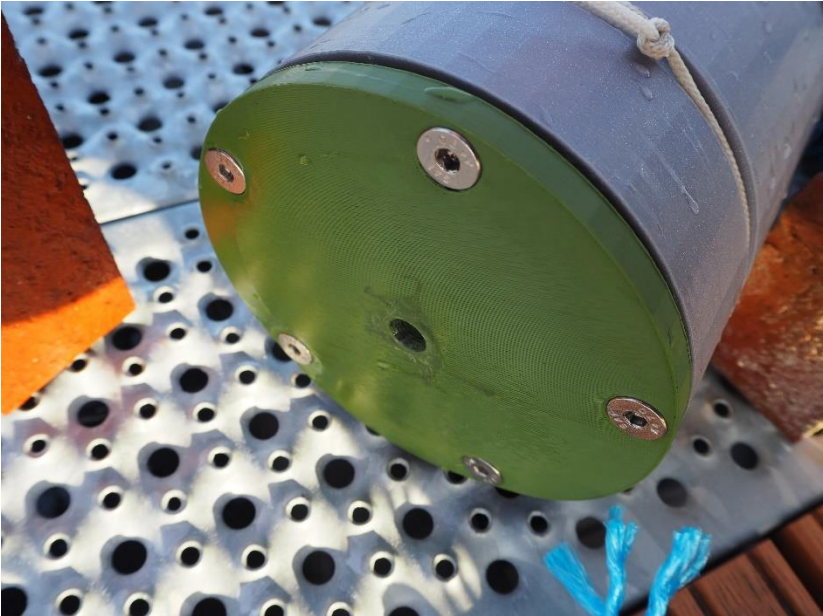

Figure 4.4 Gap between lid and container

To fix the water leakage and the fastening of the lid, a marine sealant for use below the water was smeared around the entire inside of the container as shown in figure 4.5 to the right, and it was sanded down to where it was possible to get the lid fully on, shown on the left in figure 4.5. It is also possible that the leak was between the thread and the pressure switch, and some sealant was added to the lid as well. The marine sealant needed to dry for one day. The test was then repeated to check for water leakage.



Figure 4.5 Second test improvements

Unfortunately, the second test showed negligible effect of the sealant, and test showed an equal amount of leakage. This indicates that the problem might be elsewhere, for instance with the O-ring. Maybe there is not enough pressure on the O-ring for it to be pushed down like a seal. While it is most important that the container is waterproof, it is also important to know when a battle is lost. Making the 3D printed housing waterproof proved elusive within the timeframe. Still, it was wanted to test the electronic content and the switch to check if that worked as intended. It was therefore decided that final testing with the electronic content was to be conducted. Extra protection for the electronic content, to prevent damage, was added. Another layer of the marine sealant was also added.

4.2 Final testing

To make sure that the electrical equipment was completely safe, it was also encapsulated in plastic bags to give a second layer of protection, as shown in figure 4.6 to the left. Another layer of the sealant was also added, as well as a thin layer of silicone on the top to try and create a seal between the top of the container and the surface of the lid, which is also shown in the figure 4.6 to the right.



Figure 4.6 Extra protection for the content

Isolating tape was used on the wires and around the pressure switch, to prevent damage. It still needed to be weighted down, and the bricks from previously were therefore attached to the outside of the container. The plastic bag and sealing tape was not optimal, and the concern for damage caused by the water was high. A trial test was done, where it was lowered three to four meters down before raised above the water again. The lid was then opened, and the content checked. Even the small amount of time below water had resulted in leakage at a level where it was deemed not safe to continue. For it to be tested, it needed to be lowered to below ten meters, as the pressure point of the switch was not determined. This would cause more leakage as the pressure increased. Instead, a test of the ability for the program to function inside the container with the regular switch was conducted, which is the same switch used in figure 3.5 in section 3.2. This gave a satisfying result three times, which is shown in figure 4.7 to the right (the three last messages), along with the test setup. The delays in the program were reduced to minimal, for the test to be less time demanding.

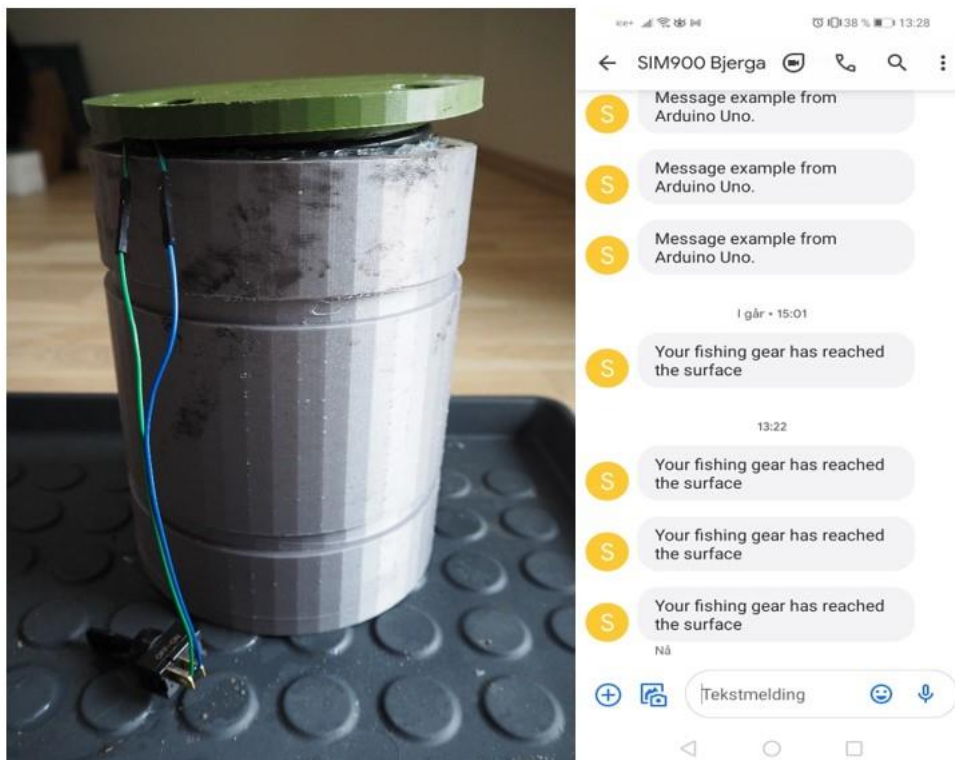

Figure 4.7 Final test

4.3 Customer review

The original plan was to create a fully functioning prototype and have crab fisher(s) test it out and provide feedback. However, due to complications with the container not being fully waterproof, the electronic content could not be secured enough for performing this test. Instead, I interviewed a potential customer in order to get valuable feedback on the prototype and the potential for a commercial product. The potential customer has competence in electromechanical engineering and is an avid crab pot user. Some questions were compiled beforehand to create a discussion around the important aspects of the final product:

- Does the design look attractive?
- Is there another color than black that is more fitting?
- What functions would you like on a product like this?
- Would this be something you would consider buying?
- At what price?

When first introduced to the product, the interviewee was very positive towards the idea of a text message when the equipment was raised above water. He had experienced on several occasions not being sure if the equipment was lost due to theft or bad weather. The idea of being able to achieve confirmation was interesting. The interviewee found the design appealing except the size, which he suggested a preferable size being a bait box which would be around half the size of the original. The original size would be acceptable for a prototype, which he offered to test it in the future. It was mentioned that the design would not impact the willingness to buy given that the product functioned correctly. A suggestion for the design was security on the attachment method, where the user could lock it in place, and potential thieves would have a hard time detaching. It was also suggested a double O-ring pattern, which would provide extra safety for waterproofing. This is standard in his workplace, which involves designing housing containing electronics meant for subsea use. Black was a preferable color as most crab pots are black. One function that was most desirable to the interviewee was the ability of location of the equipment subsea. Above water locations was also desirable. Another suggestion was a camera taking a picture of whoever raises the equipment. A function that would be fun to have would be a depth measurement.

The interviewee would consider buying the product, but the price suggested in this paper was too expensive. As he bought crab pots for around 800 NOK, he would not pay 1 000 NOK to secure it. The price would however be reasonable if it was possible to secure several crab pots at the same price.

5 Economical

One proposed business model would be the same type of concept as a fundraiser project, where the customer orders the product before it is produced at the cost price, and when enough customers have bought the product, it goes to production. For this to be a viable solution, the product would need to be as close to the finished product as possible, preferably with a prototype that is already working as intended. The visual confirmation of both design and function of the product is important to create a relationship with potential customers and appear trustworthy. This is a good solution if it is not possible to acquire any investors. As the prototype is sought to be further developed before being sold commercially, it is wanted to know how much one product would cost to make at this stage. This would indicate how expensive the product would be to commercially produce. The external advisor has envisioned a product that could be sold for around 1000 NOK. For this estimation, conversion between currencies is necessary, and these are constantly changing. Therefore, the price is estimated using prices and conversion rates from 06.05.2022. The prices are estimated for a bulk order of 20 finished products.

5.1 Product cost

The pressure switch is 610 NOK. This would not give shipping costs, as it would be possible to pick up directly. Machining the parts for the product has been estimated by Nexum Engineering to be 3 250 NOK for each container and 1 575 NOK for each lid. Which gives a total price of 96 500 NOK for 20 pieces. The electrical components are very affordable. For the Nano and its extension board, the price is 199.8 USD, which converted is 1 866.33 NOK [27]. It is also possible to order the Nano in more pieces and solder them by yourself. This would reduce the cost by 493.48 NOK [28, 29], but in return, demand more time and solder material. The SIM900 would cost 2 426.79 NOK [30]. All the circuit boards are from the same company and could give a discount if bulk ordered. The battery was 109 NOK per piece [12].

Then there are the smaller things, such as the bolts, the thread inserts, the O-ring, and the thread sealant. If accounting for 20 products, where each needs five bolts, the price of each bolt is estimated to be 3.91 NOK [31]. The thread insert is estimated to be 3.60 NOK [32]. The O-ring can be bought as a long thread and created to fit the O-ring track on the lid. This would cost 251.12 NOK for 8.5 meters of 3.5 diameter O-ring [33]. To make sure that 8.5 meters were enough, the length of each O-ring was calculated. The track for the O-ring has a diameter of 113.6 mm.

$$\begin{aligned}O_{track} &= \pi * d_{track} = \pi * 113.6 \text{ mm} = 356.88 \text{ mm} \\L_{total} &= 356.88 \text{ mm} * 20 \text{ pieces} = 7137.7 \text{ mm} \rightarrow 7.14 \text{ meters}\end{aligned}$$

(5.1)

As seen in equation 5.1, the length of 8.5 meters is more than enough. One bottle of the thread sealant would be enough for all 20 products, which costs 299 NOK [34]. Shipping costs are not accounted for.

Total costs for 20 pieces without accounting for VAT would then be:

$$\begin{aligned}Total &= 0.8 * (610 * 20 + 1866.33 + 2426.79 + 109 * 20 + 3.91 * 100 + 3.60 * 100 + 251.12 \\&\quad + 299) + 96\,500 = 112\,479.40 \text{ NOK}\end{aligned}$$

Divided into 20 pieces:

$$\text{Per piece} = \frac{\text{Total}}{20} = \frac{112\,479.40}{20} = 5\,624.00 \text{ NOK}$$

(5.2)

This gives a final cost of 5 624.00 NOK per finished product, where machining is over 80% of the cost.

5.2 Cost reduction

The cost per product in Equation 5.2 is extremely high, and as the interviewee in section 4.3 mentioned, a cost of 1000 NOK would still be too high. To find a satisfying cost for the product, and to find the production scale needed for it to be profitable, an example of size given by the interviewee is used, which is a circular design with the dimensions 75x150 mm [35]. For the cost reduction a bisected diameter of the original is used, of 80 mm. Using a wall thickness of 3 mm.

The highest cost is machining and is the primary focus for bringing costs down. Nexum Engineering provided prices for the material POM-C, from a previous order in 2016. This showed that the price was high for the diameter used in this project, 2 880 NOK per meter bolt. This gives a price of 576 NOK per container. The price for material would drastically decrease if the diameter decreased. If the size was decreased by half in diameter, the price would be 720 NOK per meter for 80 mm in diameter. This would then give a price of 82 NOK per container in material costs, with the same original length of 200. The material price has likely increased since 2016, but the decrease in price in comparison of diameter is assumed the same. Figure 5.1 shows the relationship between material costs depending on diameter, with an exponential trendline in red.

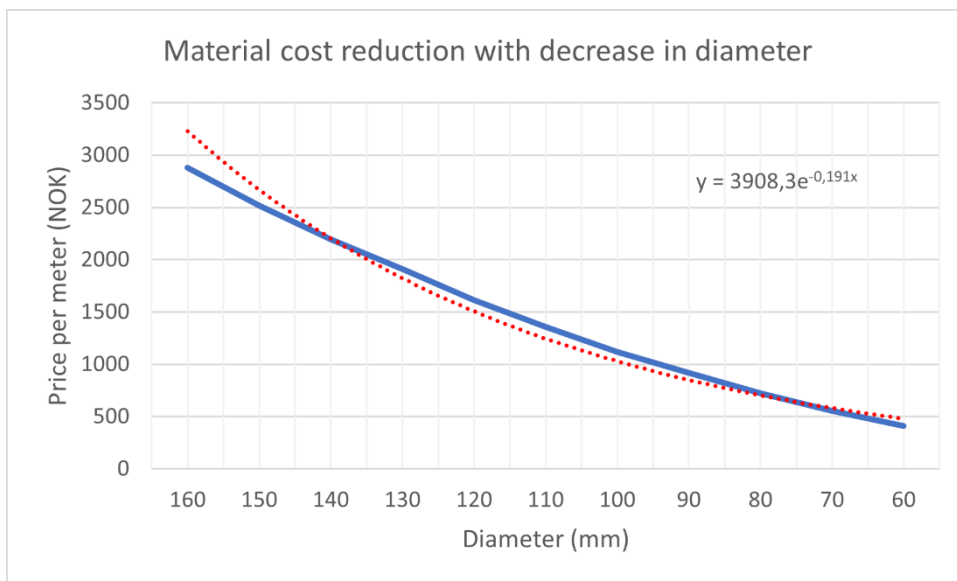

Figure 5.1 Cost reduction with decreasing diameter

It can be assumed that the costs besides the material would reduce with the same exponential amount as the material, as there would be less material to machine. Therefore, the graph for the machining can be expected to follow the same trendline equation. Starting at 4825 NOK, which is the total price for machining both parts, the graph is shown in figure 5.2. The price in machining costs can therefore be estimated to be 1 047 NOK per housing, with the diameter being 80 mm.

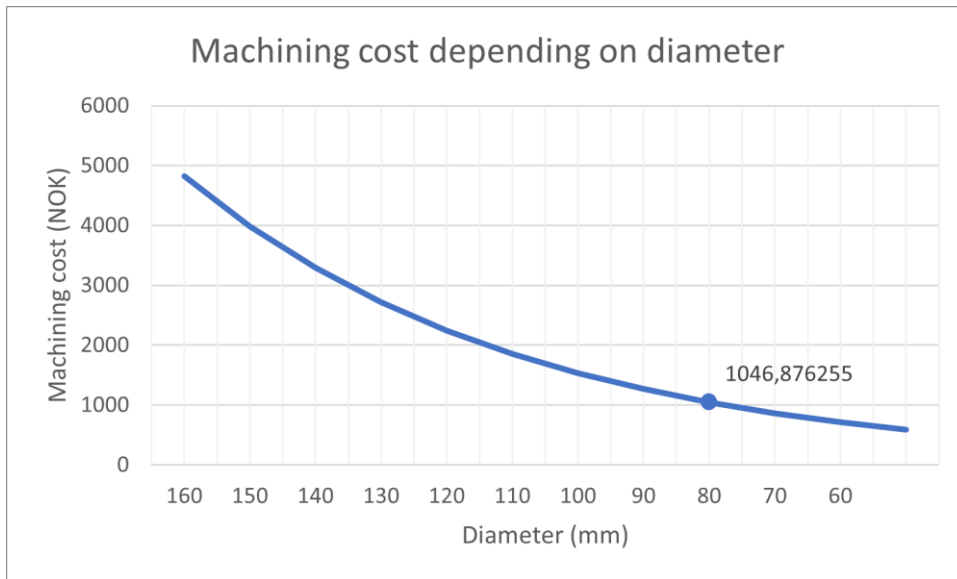

Figure 5.2 Machining costs decrease

Machining is an expensive production method, and to reduce costs substantially, it is advisable to examine other production methods, such as injection molding or 3D printing that can create waterproof housing. It might be possible to order pipes of POM-C instead of bolts, which would decrease the cost of machining substantially. The pressure switch is also a big expense but might at bulk order get a discount of 40-50%. Costs for the smaller items can also be bulk ordered, but the amount saved there is smaller. With these reductions, and assuming a 20% bulk discount in both the electrical components and the smaller items, a final cost might be:

$$\text{Cost (with reduction)} = (5624 - 4825) * 0.8 + 1047 + 610 * 0.55 = 2\,021.70 \text{ NOK}$$

This is still too high, and other production methods needs to be evaluated. An alternative to the pressure switch is also advisable to consider for reducing costs. If assuming a gross profit of 10% and VAT of 25%, this would give the product a sales price of 2 779.84 NOK. This can be assumed to be too high to be a successful product unless the customer is buying very expensive equipment. This would, however, narrow the target market substantially.

6 Discussion and further improvements

The building of the prototype provided problems, and it can be assumed that the container would have been waterproof had it been machined in POM-C instead of 3D printed. This assumption is due to POM-C already wide use in the subsea section and its resistance to water penetration. One aspect that did not work was the amount of buoyancy the container experienced, and it needed to be heavily weighted down. This needs to be further addressed, as it will be the case with POM-C as well. POM-C is however denser than the plastic used for the 3D print and would need less weight added. The price was too high to be acceptable and needs to be drastically reduced, which has been proven to be feasible in this report. If it can come to a reasonable level needs to be further studied. As a study from 2020 suggests, 3D printing using stereolithography (SLA) is particularly suited for housing used subsea [36]. This requires both very expensive equipment and materials but is faster than the 3D printing method used in this project. The electronics and program worked as it should, but especially the program can be further enhanced.

There are several other improvements that both need to be done and can be done. The first one, and probably the most important, is the size. It is now far too big to be easy to handle. It will be almost half the size of a crab pot. The calculation in section 2 provided a higher safety factor than needed, and a decrease in size is possible. This would also decrease the cost of material substantially, as well as the machining cost, as it would take less time to produce. There need to be several basic functions added: a switch or a button to switch it on and off, an inlet to provide charge to the battery, and an inlet to change the program on the card. This has not been evaluated, as this study was undertaken to examine if a simple prototype of the envisioned product could be made. As mentioned previously, 2G-network is planned to shut down in 2025, so the GSM modem would either need to run on 3G or higher, possibly also considering satellite connection, to use in areas where the mobile connection is low. To make it smaller and less complex, a designed circuit card that only contains the functions needed could be designed. This can prove very expensive but may pay out in the long run.

The vision for the product is that it contains more sensors to give feedback on the environment subsea. This can lead to the ability to have a lower price than the cost of the production of the product if the data can be sold commercially to interested parties, such as research facilities or universities. The addition of a GPS tracker is also wanted, both for the prevention of ghost fishing, but also to provide the exact location of the data received. It might be possible to connect both the notification function and location function to a satellite.

There is hardly any new technical equipment that does not come with any type of app. The app could contain an overview of all messages sent from the product and change receiving number in the app should the need arise. As the product uses a sim card, there should also be an easy way to refill the prepaid card. One aspect of the app that could provide a sales argument can be the addition of a GPS tracker, where the user could keep track of where the equipment is and has been.

How to keep the content steady and in place within the container also needs to be addressed. It is possible to create an insert that could both provide anti-static characteristics and keep the contents from freely jumping around. E.g., using dissipative trays tailored for each of the circuit cards, with an appropriate placement for the battery, giving it enough air fluctuation to get rid of ejected heat.

The environmental impact will need to be examined, and important points worth examine are mentioned in appendix D.

7 Conclusion

This project proved that the prototype is fully manageable to be created despite this prototype's unsuccessfulness. The program and electronic content were fully functioning, and only need waterproof housing. Some decisions made early in the project created problems that could have been avoided, for instance, the 3D printing of the prototype, which proved to not be waterproof enough. However, as 3D printing could reduce the cost substantially, it is worth assessing it as a solution to conventional machining. Even though the goal of this thesis was to create a functioning prototype, the project provided valuable insight into how the final product should be. The prototype contained elements that functioned as intended and can be used to further improve the product, most importantly the size. Its price, however, is not acceptable and needs to be further reduced.

8 References

- [1] H. Al-Masroori, H. Al-Oufi, and P. McShane, "Causes and mitigations on trap ghost fishing in Oman: scientific approach to local fishers' perception," *Journal of Fisheries and Aquatic Science*, vol. 4, no. 3, pp. 129-135, 2009, doi: 10.3923/jfas.2009.129.135.
- [2] T. N. Theis and H. S. P. Wong, "The End of Moore's Law: A New Beginning for Information Technology," *Computing in Science & Engineering*, vol. 19, no. 2, pp. 41-50, 2017, doi: 10.1109/MCSE.2017.29.
- [3] H. K. Kondaveeti, N. K. Kumaravelu, S. D. Vanambathina, S. E. Mathe, and S. Vappangi, "A systematic literature review on prototyping with Arduino: Applications, challenges, advantages, and limitations," *Computer Science Review*, vol. 40, p. 100364, 2021/05/01/2021, doi: <https://doi.org/10.1016/j.cosrev.2021.100364>.
- [4] N. Zlatanov, "Arduino and open source computer hardware and software," *J. Water, Sanit. Hyg. Dev*, vol. 10, no. 11, pp. 1-8, 2016.
- [5] P. Desai, *Python Programming for Arduino*. Packt Publishing, 2015.
- [6] Arduino. "Arduino Nano." Arduino. <https://store.arduino.cc/products/arduino-nano> (accessed 18. March, 2022).
- [7] H. Johnson and I. Vollstad. "Generell informasjon om slukking av 2G-nettene." Nasjonal kommunikasjonsmyndighet. <https://www.nkom.no/fysiske-nett-og-infrastruktur/informasjon-om-slukking-av-2g-i-2025> (accessed 09. May, 2022).
- [8] LastMinuteEngineers.com. "Send Receive SMS & Call with SIM900 GSM Shield & Arduino." LastMinuteEngineers.com. <https://lastminuteengineers.com/sim900-gsm-shield-arduino-tutorial/> (accessed 24. March, 2022).
- [9] Suco Robert Scheuffele GmbH & co. KG. "Pressure switches hex 24." Suco Robert Scheuffele GmbH & co. KG. <https://www.suco.de/en/pressure-monitoring/mechanical-pressure-switches/m3-pressure-switch-hex24/f1/230/> (accessed 03. March, 2022).
- [10] M. T. Inc. "megaAVR Data Sheet." Microchip Technology Inc. <http://ww1.microchip.com/downloads/en/DeviceDoc/ATmega48A-PA-88A-PA-168A-PA-328-P-DS-DS40002061A.pdf> (accessed 18. March, 2022).
- [11] G. Paller, P. Szármes, and G. Élő, "Efficient Power Consumption Strategies for Stationary Sensors Connected to GSM Network," in *SENSORNETS*, 2015, pp. 63-68.
- [12] E. AS. "2s 2200mAh - 20C - Gens Ace Soaring Mini XT60." Elefun AS. <https://www.elefun.no/p/prod.aspx?v=55573> (accessed 06. May, 2022).
- [13] Maritim Båttutstyr. "Sammenleggbare krabbeteine." Maritime Båttutstyr. <https://www.maritim.no/krabbeteine-sammenleggbare-liten-7kg> (accessed 15. March, 2022).
- [14] Vink Norway AS. "Teknisk Datablad - POM." Vink Norway AS. <https://vink.no/produkter/industri/konstruksjonsplast/pom> (accessed 06. April, 2022).
- [15] Nickel Institute. "DESIGN GUIDELINES FOR THE SELECTION AND USE OF STAINLESS STEELS." Nickel Institute. https://nickelinstitute.org/media/4664/ni_aisi_9014_selectionuse.pdf (accessed 22. March, 2022).
- [16] Parker Hannifin GmbH O-Ring Division Europe. *Precision O-Ring Handbook*, March 1997 ed., Parker Hannifin GmbH, Germany, Catalogue 5705 E, 1997.
- [17] P. Webb. "Introduction to oceanography." Roger Williams University. <https://rwu.pressbooks.pub/webboceanography/chapter/6-3-density/> (accessed 24. March, 2022).
- [18] K. Gramoll. "Mechanics - Theory." eCourses. https://www.ecourses.ou.edu/cgi-bin/ebook.cgi?topic=me&chap_sec=02.3&page=theory (accessed 21. April, 2022).
- [19] U. o. Washington. "Thick Walled Cylinders." University of Washington. <http://courses.washington.edu/me354a/Thick%20Walled%20Cylinders.pdf> (accessed 21. March, 2022).
- [20] H. G. Lemu, *Dimensjonering av maskinelementer* (Kompendium i fag MSK210). Stavanger: University of Stavanger, 2020.

- [21] PaulStoffregen. "AltSoftSerial." Github. <https://github.com/PaulStoffregen/AltSoftSerial> (accessed 05. May, 2022).
- [22] C. Nelson. "Floating Inputs." Adafruit. <https://learn.adafruit.com/circuit-playground-digital-input/floating-inputs> (accessed 09. May, 2022).
- [23] A. Peck. "Arduino: Pushbutton." Peck, Akkana. <https://shallowsky.com/arduino/class/button.html> (accessed 09. May, 2022).
- [24] I. J. Jacob, S. K. Shanmugam, S. Piramuthu, and P. Falkowski-Gilski, *Data Intelligence and Cognitive Informatics: Proceedings of ICDICI 2020*. Springer Singapore, 2021.
- [25] G. Hodgson. "Slic3r Manual." Slic3r. <https://manual.slic3r.org/troubleshooting/dimension-errors> (accessed 14. March, 2022).
- [26] Prusa Research AS. "FAQ - Frequently Asked Questions." Prusa Research. https://help.prusa3d.com/en/article/faq-frequently-asked-questions_1932 (accessed 12. March, 2022).
- [27] Banggood. "Funduino Nano Expansion Board + ATmega328P Nano V3 Improved Version." Banggood. https://www.banggood.com/Funduino-Nano-Expansion-Board+-ATmega328P-Nano-V3-Improved-Version-p-1011009.html?cur_warehouse=CN&rmmds=buy&fbclid=IwARORFxm52plEdzwxpTiACAzuAiTQIaIP1cghW5IAvXp7IG8GI8U4W00cyeo (accessed 06. May, 2022).
- [28] Banggood. "Geekcreit® ATmega328P Nano V3 Controller Board Improved Version Module Development Board - 20pcs." Banggood. https://www.banggood.com/Geekcreit-ATmega328P-Nano-V3-Controller-Board-Improved-Version-Module-Development-Board-p-940937.html?rmmds=product_topselling&cur_warehouse=CN&act_poa=1xSKU157951&ID=520515 (accessed 06. May, 2022).
- [29] Banggood. "10Pcs Multi-Function Funduino Nano Shield Nano Sensor Expansion Board." Banggood. https://www.banggood.com/10Pcs-Multi-Function-Funduino-Nano-Shield-Nano-Sensor-Expansion-Board-p-1165787.html?rmmds=detail-left-hotproducts&cur_warehouse=CN&trace_id=dccb1651831096130 (accessed 06. May, 2022).
- [30] Banggood. "SIM900 Quad Band GSM GPRS Shield Development Board Geekcreit for Arduino - products that work with official Arduino boards." Banggood. https://www.banggood.com/SIM900-Quad-Band-GSM-GPRS-Shield-Development-Board-Geekcreit-for-Arduino-products-that-work-with-official-Arduino-boards-p-964229.html?imageAb=2&p=MA240439985285201910&akmClientCountry=NO&cur_warehouse=CN (accessed 06. May, 2022).
- [31] Skrujernet.no. "ISO 10642 senkodeskrue, syrefast A4, M8." Skrujernet.no. <https://www.skrujernet.no/no/iso-10642-a4-m8-senkodeskrue-syrefast> (accessed 06. May, 2022).
- [32] Biltema. "Gjengeinnsatser." Biltema. <https://www.biltema.no/verktoy/handverktoy/gjengeverktoy/gjengeinnsatser-2000022430> (accessed 06. May, 2022).
- [33] RS components AS. "RS PRO Nitrile Rubber O-Ring Cord, 3.5mm Diameter, 8.5m Length." RS Components AS. <https://no.rs-online.com/web/p/o-ring-cords/1381602> (accessed 06. May, 2022).
- [34] MegaFlis. "LOCTITE GJENGETETTING 577 ACC, 50 ML." MegaFlis. https://www.megaflis.no/bad/sluk-vann-og-avlop/ror--avlopsdeler/loctite-gjengetetting-577-acc-50-ml?gclid=CjwKCAjwjtOTBhAvEiwASG4bClaw76gQvfmCRkF2wOpHVVIAjKyZHyQx2O8YYY14xW09wRGjJHRbthoC--MQAvD_BwE (accessed 06. May, 2022).
- [35] Fiskehjørnet AS. "Agnboks, 4 mm hull." Fiskehjørnet AS. <https://www.garnbua.no/products/agnboks-4-mm-hull> (accessed 12. May, 2022).
- [36] B. T. Phillips *et al.*, "Additive manufacturing aboard a moving vessel at sea using passively stabilized stereolithography (SLA) 3D printing," *Additive Manufacturing*, vol. 31, p. 100969, 2020/01/01/ 2020, doi: <https://doi.org/10.1016/j.addma.2019.100969>.

9 Appendices

- Appendix A - Program 32
- Appendix B – Technical drawing of container 34
- Appendix C – Technical drawing of lid 35
- Appendix D – Enviromental impact important points 36
- Appendix E – Simple circuit schematic..... 37
- Appendix F – Part list..... 38

Appendix A - Program

```
#include <AltSoftSerial.h> // Needs to be included to communicate through software serial
#include <GSM.h> // Library for the GSM card.
#include <LowPower.h> // Library for powering down the micricontroller, to save battery power

// Configure software serial port
AltSoftSerial SIM900(8, 9); // SIM900 Tx and Rx is connected to Nano pin 8 and 9, respectively

// Adding variables to be used later in the program
int pinswitch = digitalRead(2); // Register what value the input from pin 2 has, which is the pressure switch pin.
GSM gsmAccess(true);
GSM_SMS sms;
GSMScanner scannerNetworks;

void setup()
{
  delay(1000); // Give time for the crab pot to be lowered into water
}

void loop() {
  pinswitch = digitalRead(2);
  while (pinswitch == LOW)
  {
    delay(1000);
    pinswitch = digitalRead(2);
    if (pinswitch == HIGH)
    {
      // Arduino Nano communicates with SIM900 GSM shield at a baud rate of 115200
      SIM900.begin(115200);
      // Starts the SIM900 up
      SIM900power();
      boolean network = true;
      scannerNetworks.begin();
      // This whileloop is to make sure that the SIM900 has network connection before sending SMS
      while (network)
      {
        gsmAccess.begin();
        // Checking the network connection
        if (gsmAccess.getStatus() == GSM_READY)
        {
          // Send the SMS
          sendSMS();
          // Power down the SIM900 GSM shield
          SIM900power();
          network = ! network;
        }
        else
          delay(1000);
      }

      delay(30000);
      pinswitch = digitalRead(2);
      // Needs to make sure the text is not sent several times
      while (pinswitch == HIGH)
      {
        delay(600000);
        pinswitch = digitalRead(2);
      }
    }
    else
      LowPower.powerDown(SLEEP_4S, ADC_OFF, BOD_OFF);
    // Power down the microcontroller, as to prevent it from using too much power, waking up every 4 seconds and running again
  }
  LowPower.powerDown(SLEEP_4S, ADC_OFF, BOD_OFF);
}
```

```

void SIM900power()
{
  pinMode(10, OUTPUT);
  digitalWrite(10, LOW);
  delay(1000);
  digitalWrite(10, HIGH);
  delay(2000);
  digitalWrite(10, LOW);
  delay(3000);
}

void sendsms() {
  // AT command to set SIM900 to SMS mode
  SIM900.print("AT+CMGF=1\r");
  delay(100);

  // Phonenumber that the SMS is sent to
  SIM900.println("AT+CMGS="+4797315939");
  delay(100);

  // The content of the SMS
  SIM900.println("Your fishing gear has reached the surface");
  delay(100);

  // End AT command with a ^Z, ASCII code 26
  SIM900.println((char)26);
  delay(100);
  SIM900.println();
  // Give module time to send SMS
  delay(5000);
}

```

Appendix B – Technical drawing of container

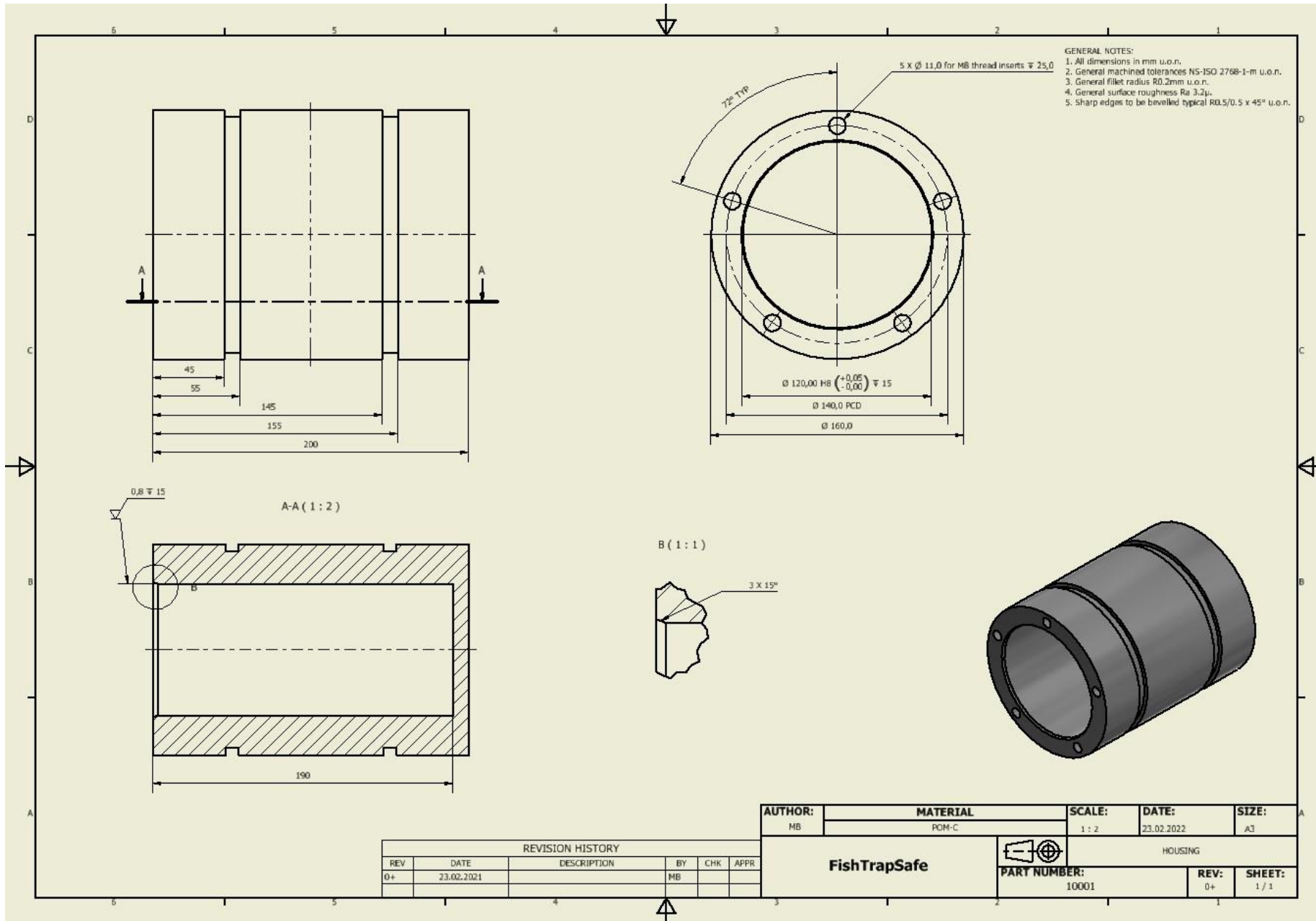

REVISION HISTORY					
REV	DATE	DESCRIPTION	BY	CHK	APPR
0+	23.02.2021		MB		

AUTHOR: MB	MATERIAL: POM-C	SCALE: 1 : 2	DATE: 23.02.2022	SIZE: A3
FishTrapSafe		HOUSING		
		PART NUMBER: 10001	REV: 0+	SHEET: 1 / 1

Appendix C – Technical drawing of lid

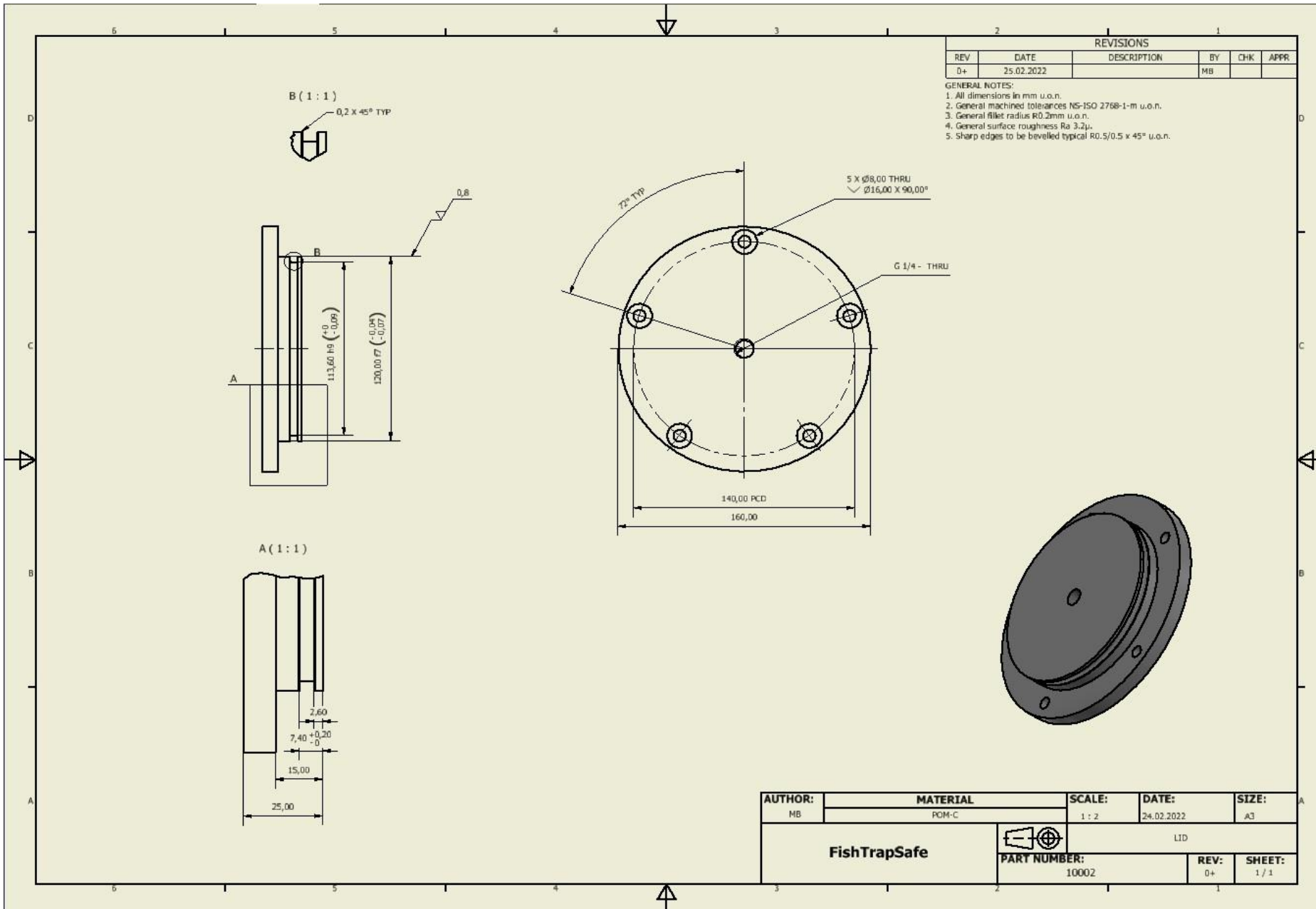

Appendix D – Environmental impact important points

- Increased pollution from producing new product which is not replacing
- Can the material enter circular economy?
- Rare materials used in electronics (circuit board and battery)
- Easy and readily available recycling of electronics and plastic
- Local pollution from nano- and micro-particles, especially for plastic subsea
- Locally used products instead of long-distance transportation

Appendix E – Simple circuit schematic

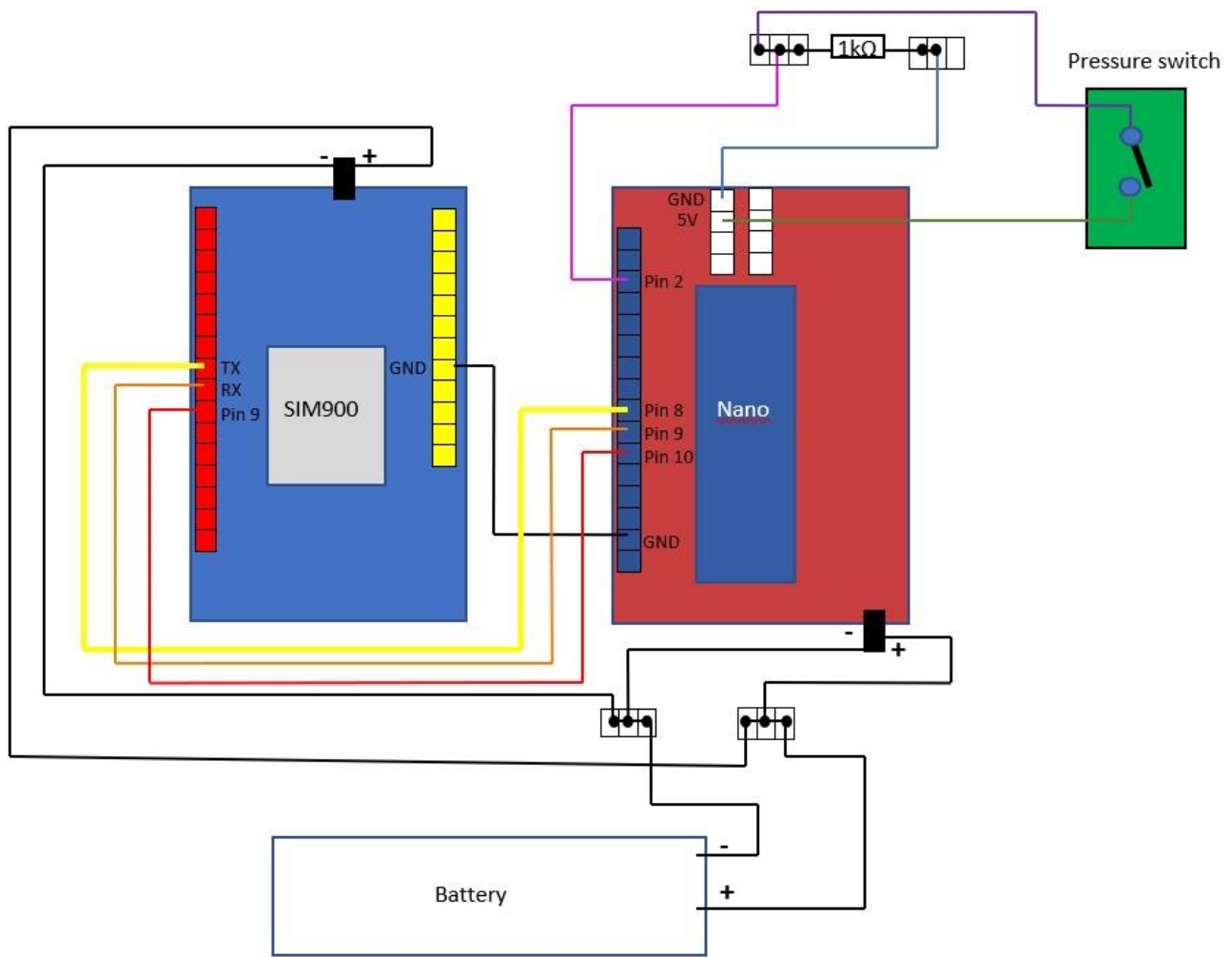

Appendix F – Part list

PART LIST			
ITEM	QTY	PART NAME	DESCRIPTION
1	1	Container	POM-C
2	1	Lid	POM-C
3	1	O-ring	Ø 3.62
4	5	Countersunk bolt M8	A4-80 quality
5	5	Insert	M8 size
6	1	Arduino Nano	Circuit board
7	1	Extension Shield	Circuit board
8	1	SIM900 GSM Shield	Circuit board
9	1	Pressure Switch	Witec Hydraulics, G1/4
10	8	Wire	General electronics
11	4	Electrical connectors	General electronics
12	1	Power cord	Supplying power from battery
13	1	Battery	2200 mAh
14	1	Resistor	1kΩ