



Universitetet
i Stavanger

FACULTY OF SCIENCE AND TECHNOLOGY

MASTER'S THESIS

Study programme/specialisation:

Spring / Autumn semester, 20.....

Open/Confidential

Author:

.....
(signature of author)

Programme coordinator:

Supervisor(s):

Title of master's thesis:

Credits:

Keywords:

Number of pages:

+ supplemental material/other:

Stavanger,.....
date/year

Preparation and Reactions of Strained *gem*-Dibromocyclopropanes

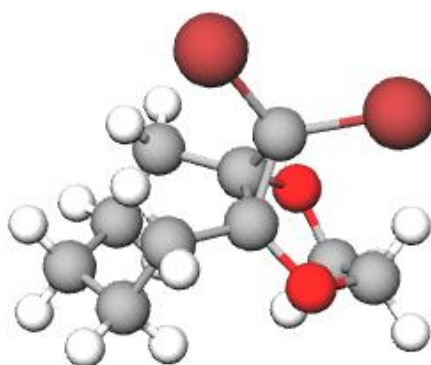

Acknowledgment

I am profoundly thankful to my supervisor Einar Bakstad. His supervision over the last year has been invaluable. Einar was an incessant source of knowledge and also an enjoyable presence. I will forever look back at this last year as the most enlightening and fruitful academic experience I had so far. I sincerely cannot think of any better supervisor to have had.

I am thankful to Jørn also for being my colleague and friend. Your company never for a second stopped being anything but pleasant. I have the utmost respect for your quality of being an eternal thinker -at all times challenging your mind, building and developing ideas. You were always full of insights that were interesting to discuss.

I am grateful to all of my family and friends who both actively and silently supported me in this period that demanded so much time and focus. To my parents Rixia and Raul, for always voicing their concerns and support and always wanting to help. My brothers Manuel and Angel for being patient and supportive. You are and have always been role models to me.

My deepest thank you to Marta. You have been sweet, loving, and supportive to no end. I could never help but feel comfort and relief in your company. This I greatly treasure.

Thanks also to Elza for being a neverending source of happiness and love.

I would like to extend my gratitude to Manuel and Jørn again as well as Katja for their helpful comments on my thesis. Thank you to Kåre Jørgensen for his patience and helpfulness regarding access to the NMR and IR instruments at the university, and to Sindhu for her very friendly guidance with these.

Last but not least, a warm thank you to professor Skattebøl for his insights into the investigations, and for his help regarding analytical tests.

I am lucky and grateful to work where my passion lies.

Abstract

Two main objectives drove the present effort. First and foremost, reactions of strained *gem*-dibromocyclopropanes with MeLi were to be investigated as a continuation of research done by Lars Skattebøl. Secondly, the overcoming of challenges regarding synthesis of α -hydroxyketones was pursued.

Strained *gem*-dibromocyclopropanes were prepared by building a dioxin ring upon seven- and eight-membered acyloins to arrive at bicyclic vinyl ethers and subsequently adding dibromocarbene. Oxathia- analogues of these vinyl ethers were also synthesized and cyclopropanated. Several pathways for their preparation were explored. Attempts at improving upon the method developed in Bakstad's research group were not particularly successful and gave few good results that were difficult to reproduce. Experiments in the synthesis of benzyl-protected acyloins gave complex mixtures of products and instead hinted at α -ketol or Favorskii rearrangements, while synthesis of acetyl-protected acyloins only worked for acetophenone relatives.

A simple, versatile method previously undescribed involving epoxidation of enol acetates was developed that worked for the synthesis of acyloins and dihydrodioxins in two steps. The method sparked interest in the cyclopropanations and ring-openings of such enol acetates, which were briefly explored. The corresponding dibromocyclopropanes could not be isolated for ring-openings. In addition, a novel procedure for the preparation of 1,2-diketones was discovered as a result of the novel acyloin/dihydrodioxin synthesis.

Dibromocarbene was readily added to dihydrodioxins and dihydrooxathiins to afford strained propellanes. *gem*-Dibromopropellanes **8a** and **8b** reacted with MeLi to give the corresponding monobromides, **9a** and **9b**. Formations of **9a**, **9b**, and **10a** were confirmed by additional isotope labelling experiments with heavy water. Reactions with benzyl bromide did not afford the expected coupling product but instead the reduced one, **9a**, as when quenched with water.

Carbene trapping experiments with ethylvinyl ether were unsuccessful as the dibromides were left unreacted. Carbene insertion experiments with THF did not afford the expected insertion product **13a** -instead, the dibromides reacted with MeLi and proceeded to dimerize to yield **14a**. Additional analytical results of the MeLi reaction products are currently pending.

Contents

Acknowledgment	3
Abstract	4
1. Introduction	6
1.1 Carbenes.....	6
1.2 The chemistry of <i>gem</i> -dihalocyclopropanes	7
1.3 Applications of carbene chemistry	9
1.3.1 Applications in biochemistry	9
1.4 Background and purpose of the study.....	11
1.5 Previous work.....	15
1.5.1 Previous advancements in the chemistry of strained molecules	15
1.5.2 Preparation of starting materials -synthetic strategies	17
2. Results and discussion.....	22
2.1 Preparation of vinyl ethers.....	22
2.1.1 Development of the acyloin synthesis developed in Bakstad's group.....	22
2.1.1.1 Protection groups: α -benzyloxyketones	23
2.1.1.2 Protection groups: α -acetoxyketones	27
2.1.2 Development of new methods: Oxidation of vinyl esters.....	29
2.1.3 Synthesis of vinyl ethers	33
2.2 Emergent applications	34
2.2.1 Novel synthesis of 1,2-diketones	34
2.2.2 Applications in Bakstad's ring-opening investigations	37
2.3 Chemistry of strained <i>gem</i> -dibromocyclopropanes	38
2.3.1 Preparation of strained <i>gem</i> -dibromocyclopropanes.....	38
2.3.1 Reactions of <i>gem</i> -dihalocyclopropanes with methyllithium.....	39
3. Conclusion.....	43
4. Experimental	45
5. Abbreviations	58
6. Appendix	59
7. References	62

1. Introduction

This work represents some of the latest advancements in the chemistry of strained molecules pioneered by professor Lars Skattebøl and was done in collaboration with him and his research group.

1.1 Carbenes

Carbenes are a type of reactive intermediates defined as divalent neutral carbons containing two non-bonding electrons. Two possible configurations of carbenes exist: a carbene where its two non-bonding electrons occupy two different orbitals with parallel spins, and one in which they occupy the same orbital in antiparallel spins in an sp^2 hybridized. These two configurations have been catalogued as triplet and singlet carbene, respectively.

Though they belong to the same category of reactive intermediates, these two types of carbenes can differ immensely from one another in their chemistry. For instance, addition of singlet carbene to double bonds is an electrocyclic reaction and is therefore stereospecific. The same is not true for the triplet carbene.

The most obvious factor affecting their reactivity is the geometry that they adopt, followed by differences in their energies. Triplet carbenes are commonly regarded to have lower energies than their singlet counterparts, but this is greatly dependent on the conditions in which they are generated, the environments they are exposed to thereafter, and the substituents they carry with them. In general, carbenes are very reactive species, and are therefore very short-lived.

Carbenes have over decades continued to intrigue scientists due to their remarkable and varied reactivity, and maintain a status of relative exoticism as select groups of chemists explore the extent and limits of their reactivities, leading to, for instance, achievements in two opposite ends of the spectrum regarding their stabilization, with persistent carbenes^[4] contrasting particularly reactive ones such as the singlet methylene carbene, which can even add to benzene to produce a bicyclic heptadiene^[12].

At the same time, they have been the subject of research in quite sophisticated chemistry. In fact, carbenes have found their way to Nobel Prize-awarding findings in the olefin metathesis, a reaction involving metallocarbenoid species for which Richard Schrock, Robert Grubbs, and Yves Chauvin shared the prize in 2005.

Several reactions have been attributed as characteristic of (and some nearly exclusive to) carbenes:

- The carbene insertion into activated C-H bonds, which has for example been exploited by P. Müller in the synthesis of some furanes^{[2][3]}.
- The carbene dimerization, consisting of the coupling of two carbenes to form a double bond.
- The carbene addition to double bonds, yielding cyclopropanes.

For the purposes of the present investigations, only the latter reaction of singlet dihalocarbenes to yield *gem*-dihalocyclopropanes is relevant. It is important to recall that this is a cheletropic reaction, and as such will preserve the stereochemistry of the original olefin.

Indeed, the formation of *gem*-dihalocyclopropanes from dihalocarbenes and alkenes is one of the most studied and exploited reactions in carbene chemistry^{[1][5]}. In addition to discoveries in ways to generate carbenes -such as Mąkosza's famous Phase Transfer Conditions (PTC)-, the resulting cyclopropanes are often susceptible to further chemistry through their ring-openings as well as substitution and elimination reactions^[6], making carbenes and cyclopropanes the center of extensive research, leading to the focus of this paper.

1.2 The chemistry of *gem*-dihalocyclopropanes

Cyclopropanes are the most strained of the cyclic alkanes, a feature mainly stemming from the triangular planar geometry that demands a total sum of 180° degree covalent angles from their ring-constituent carbons. Therefore, release of ring-strain is often the main driving force behind their ring-opening reactions. However, such reactions are very dependable on the conditions which provoke them and on the ring's substituents, a characteristic that allows them to give rise to a wide range of products^{[6][7][8]}. Therefore, many research groups have focused on carefully inducing their ring-openings in attempts to control them and arrive to certain products consistently.

For example, the Bakstad research group has in later years been particularly interested in the base-induced ring-opening of *gem*-dihalocyclopropanes^[1]. Arct and Migaj described such reactions as proceeding through hydrohalo-elimination to the corresponding strained cyclopropenes^[9] which may be followed by interception with a trapping agent, such as a nucleophile, or by rearrangements to vinylcarbenes at or below room temperature (r.t.) when trapping agents lack. The latter can in turn insert into C-H bonds, or yield cyclopropanes if intercepted with other alkenes.

gem-Dihalocyclopropanes may instead undergo a thermal electrocyclic ring-opening assisted by the departure of a halide, producing an allylic cation that is subsequently intercepted by any present nucleophile. Hydrolysis of the adduct culminates the process to yield 2-halo-2-propenones or, if conditions are sufficiently alkaline, the corresponding acetylenic ketones by further hydrohalo-elimination. Müller and Pautex investigated both of these pathways and summarized them in 1991^[7] (Scheme 1).

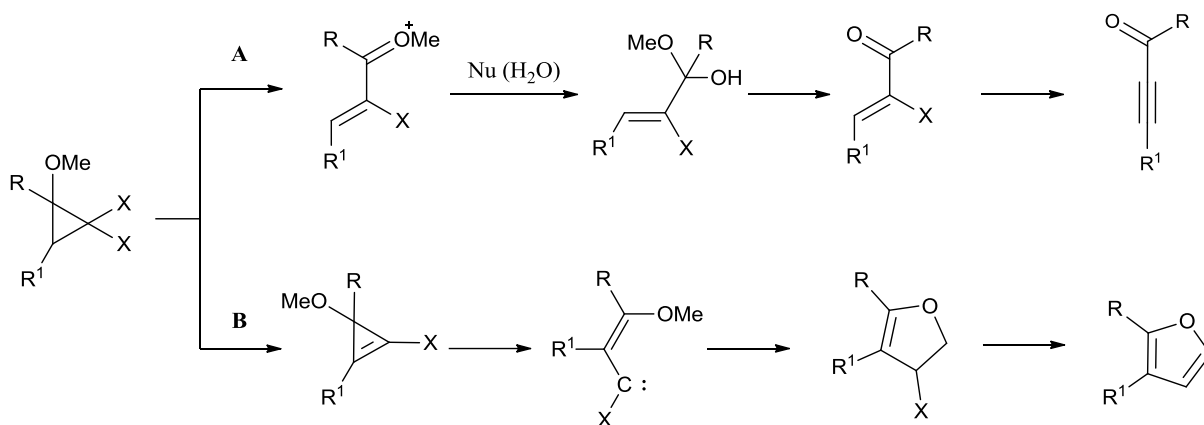

Scheme 1: Summary of ring-opening pathways of *gem*-dihalocyclopropanes by P. Müller and N. Pautex^[7]. Thermal electrocyclic ring-openings to α,β -unsaturated carbonyls (**A**) vs. Base-induced hydrohalo-elimination to cyclopropanes (**B**).

E. Bakstad's contribution to this field is in his development of a base-induced generation of alkoxy-substituted dihalocyclopropanes that contrasts the previously mentioned one by avoiding rearrangement to vinylcarbenes and yields acetylenic acetals instead.

As mentioned before, these cyclopropanes tend to instead be readily intercepted by nucleophiles, such as alkoxides, as this releases ring-strain. This in fact represents an effective option for the generation of newly alkoxy-substituted cyclopropanes. This concept can be adapted even further to regio-selectively substitute the cyclopropane, with the help of certain substituents (Scheme 2). For example, potassium *tert*-butoxide (*t*-ButOK) tends to induce rearrangements to vinyl-carbenes (Scheme 1, **B**) as it is a strong base but not as good a nucleophile. Potassium *iso*-propoxide (*i*-PrOK) is a better nucleophile and therefore better able to attack the cyclopropane to release ring-strain and produce a C2/C3-alkoxy substituted cyclopropane (Scheme 2). Furthermore, 2-phenyl-1,1-dihalocyclopropanes could react with bases to produce a benzyl-stabilized anion, which nucleophiles can intercept to substitute the cyclopropane at C1.

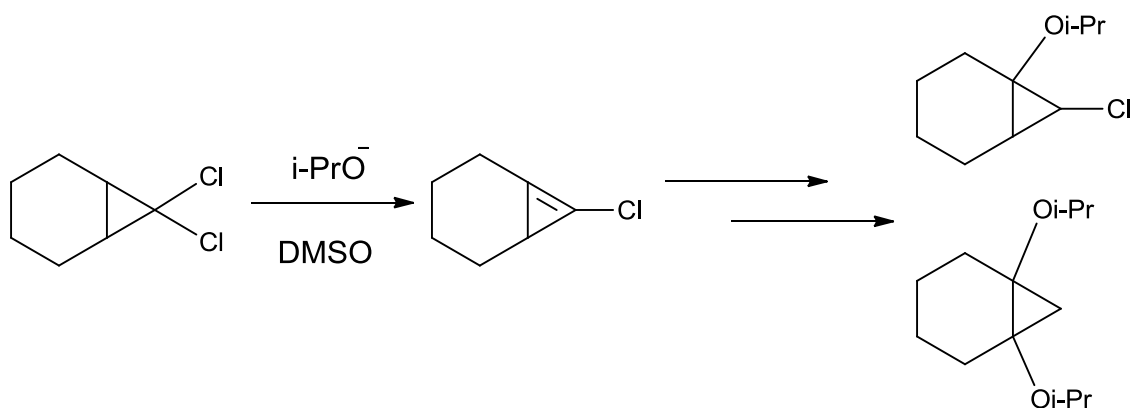

Scheme 2: *iso*-Propoxide successively substitutes the 1,1-dichlorobicyclo[4.1.0]heptane cyclopropane at C2 and C3 in DMSO.

1.3 Applications of carbene chemistry

It is evident from only a brief glance that carbenes and cyclopropanes offer a great variety in terms of chemistry. The fact that they have in occasions found themselves applicable in biochemistry, medicine and as useful building blocks to biologically active compounds should not be ignored. Following are some examples of carbenes and cyclopropanes being used for these purposes.

1.3.1 Applications in biochemistry

Already from the overview by Müller and Pautex arise several synthetic pathways. One can trap a cyclopropene intermediate, for instance with a diene in a Diels-Alder (DA) reaction to arrive at bicyclic compounds. Comparatively, one can opt to instead induce an electrocyclic ring-opening to isolate electron-deficient alkenes or acetylenes; excellent building blocks for employment in DA reactions or as Michael acceptors. Cyclopropanes and alkynes have also been used in both inter- and intramolecular cycloaddition reactions (Scheme 3) when synthesizing complex compounds such as esters of phorbol^[13].

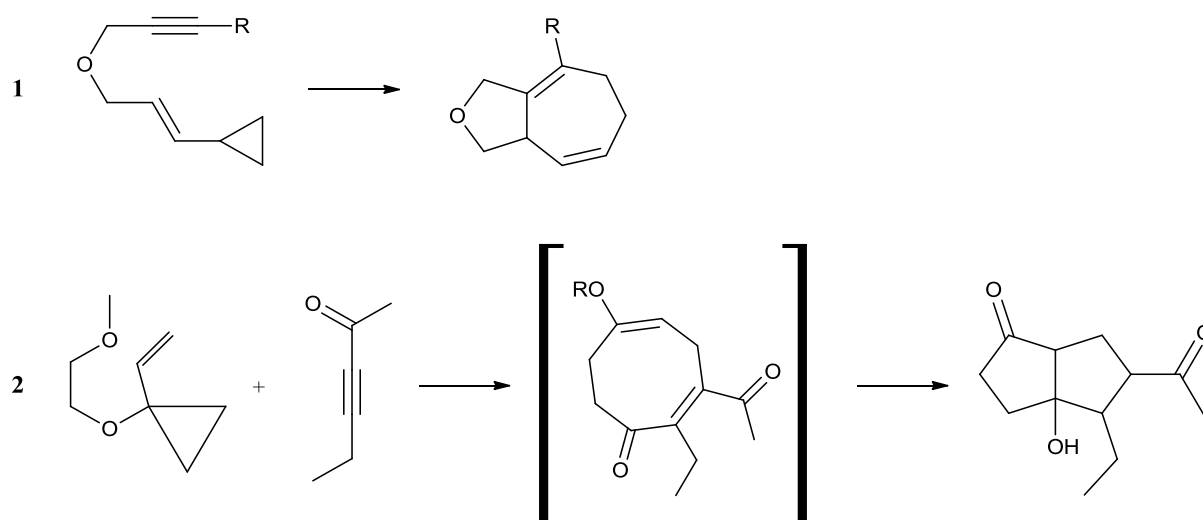

Scheme 3: Example of an internal (1) and an external (2) cycloaddition between an alkyne and a vinyl cyclopropane. Both examples were taken from the same study at Stanford University, where several more were described^[12].

As mentioned, elimination of hydrogen halides can lead to the formation of a vinylcarbene, exploited by the aforementioned in the synthesis of phenanthrofuranes and phenanthrocyclopentadienes^{[2][3][5][7]}. In fact, carbene insertions are widely used and reliable techniques in the synthesis and functionalization of macromolecular structures. Interestingly, since the first descriptions of diazirines as carbene precursors^{[14][15]} (Scheme 4) they have proven useful not only for that purpose, but also as photophores in photoaffinity labelling, encouraging scientists to introduce them into carbohydrate structures^{[16][17]}, steroid structures^[18], and several

other biological macrostructures^[19] (Scheme 5) in order to better study the relationships between structure and biological activity.

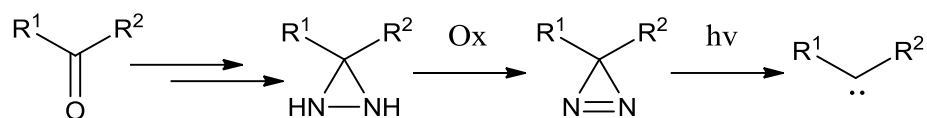

Scheme 4: Diaziridines are produced from ketones and can then be converted to diazirines through oxidation. They produce carbenes when irradiated with ultraviolet light.

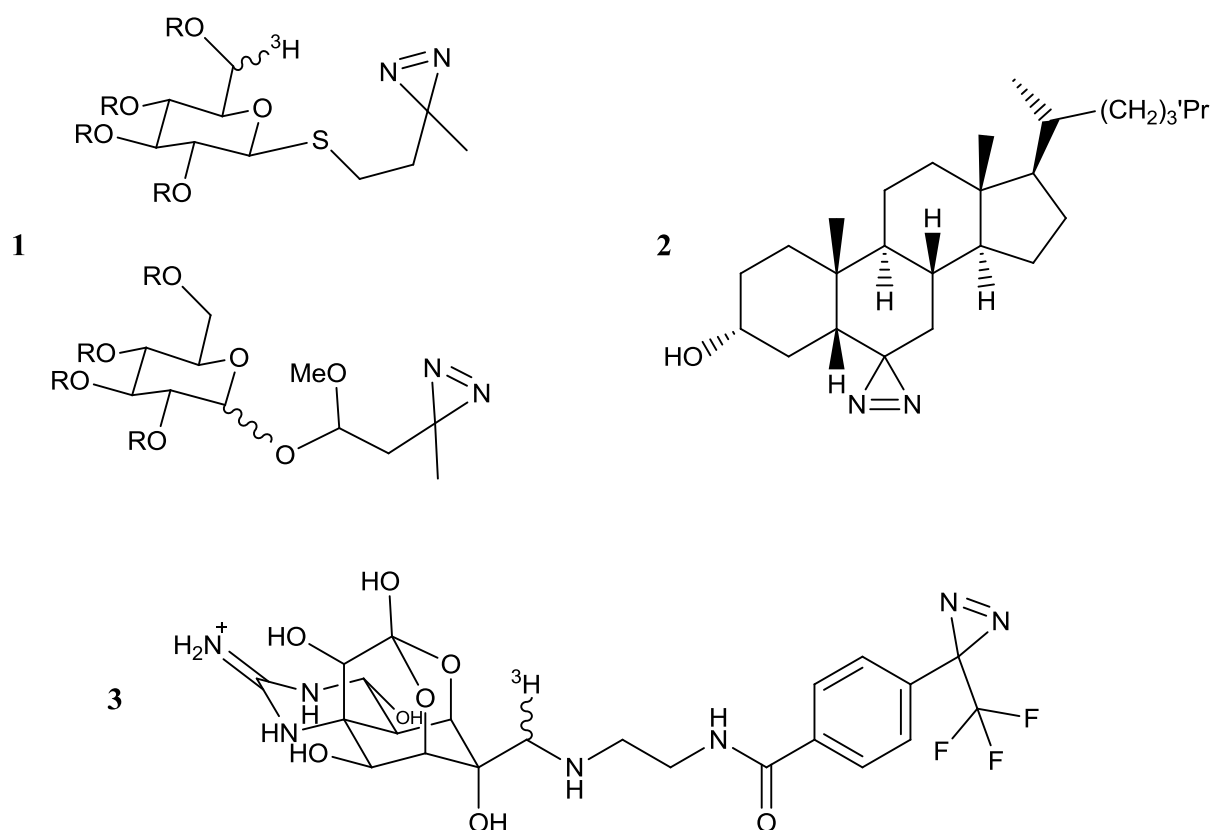

Scheme 5: Diazirine analogues of some interesting bioactive compounds used for photoaffinity labelling. α - Or β -anomerized glucosides^[16] as well as sulphur analogues^[17] (**1**). Analogues of steroids^[18] (**2**), and infamous fugu-fish toxin tetrodotoxin (**3**)^[19].

Though so far in only in-vitro studies, *gem*-dihalocyclopropanes substituted at C2 and C3 have also been tested and found to induce concentration-dependent apoptosis and growth inhibition and to coordinate the regulation of apoptotic genes in TRAMP cells^[20], inhibit tubulin assembly and cause microtubule loss in breast cancer cells, although some E-isomers were inactive^[21].

Indeed, one can see how carbenes and cyclopropanes are potent agents that can, with calculated planning, be manipulated to fit a number of uses in chemistry, biochemistry, and medicine, making them extremely interesting species to explore. In the next chapter the last applications of *gem*-dihalocyclopropanes will be discussed -these are the most important and basis for this entire research project.

1.4 Background and purpose of the study

Dr. Lars Skattebøl is a Norwegian chemist that has dedicated a large part of his career to the study of carbenes and cyclopropane reactions. Skattebøl has pioneered the cyclopropane and strained molecules' chemistry front repeatedly, and went on to receive several scientific awards, become chair of the Norwegian Chemical Society, and an editorial member of *Acta Chemica Scandinavica*. Today, he is still a professor emeritus at the university of Oslo. His impressive work is the basis of the present paper as well as inspiration for some of his former students' own projects in the field.

Amongst one of them is Dr. Einar Bakstad, now head of research in the Biosynth Laboratories in Sandnes, Norway. As mentioned previously, he has developed a ring-opening process based on reactions performed by Skattebøl. When Skattebøl introduced alkoxides to *gem*-dihalocyclopropanes, he was able to promote a hydrohalo-elimination by a cyclopropenyl cation-allyl cation electrocyclic ring-opening^[26] (Scheme 1, A). Meanwhile, Bakstad realized a method that not only directly afforded acetylenic acetals in high yield, but did so even below r.t. and by an entirely different mechanism (Scheme 6).

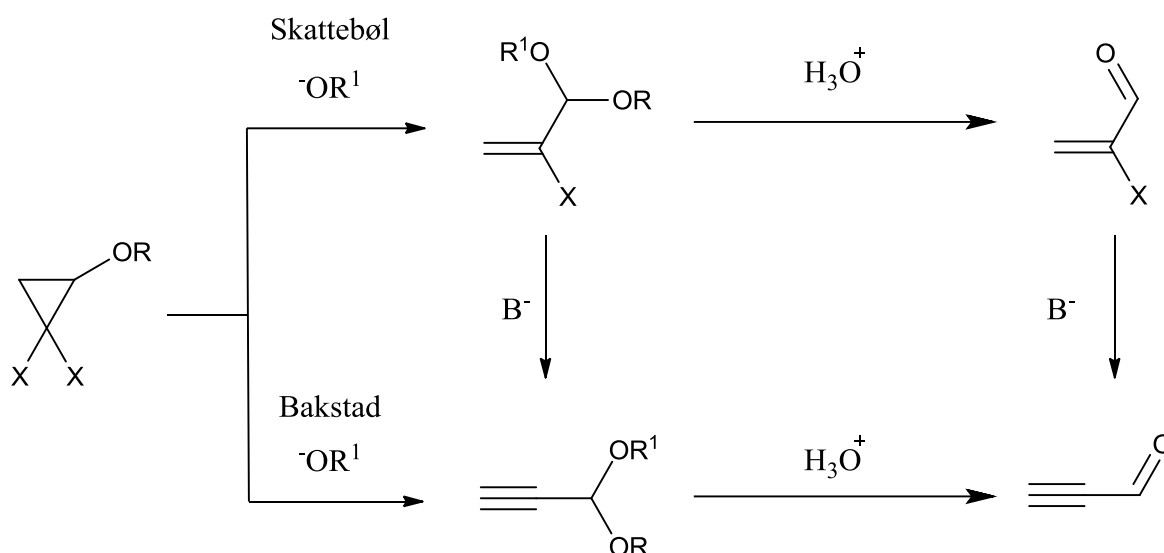

Scheme 6: Skattebøl's vs. Bakstad's approach. Skattebøl's affords vinylhalides and requires an extra step to arrive to the corresponding acetylenes.

For years, Skattebøl focused on the reactions of *gem*-dihalocyclopropanes with several reducing agents, such as sodium aluminium bis(2-methoxyethoxy)hydride (SAH)^[22] to arrive at the corresponding monohalogenated and dehalogenated cyclopropanes.

Skattebøl first developed and reported reactions of *gem*-dihalocyclopropane derivatives and alkyllithium reagents^{[23][24]}, in the early 60s inspired by work done by Döering and Laflamme^[25]. He found that *gem*-dihalocyclopropanes reacted with alkyllithium to effectively afford allenes^[23] -even cyclic allenes- and observed that the dibromo analogues reacted more readily than the dichloro- ones, which were found to react with butyllithium (BuLi) and not with methyllithium (MeLi). This marked the beginning of his relentless research into these cyclopropane reactions, work that he called "Chemistry of *gem*-dihalocyclopropanes" and of which several volumes are published to different scientific journals^{[24][26][27]}.

Realizing this was the only practical allene synthesis at the time he continued to pursue this chemistry^[24]. He proposed that the formation of allenes was initiated by a metal-halogen exchange to the corresponding organolithium cyclopropane, finally eliminating lithium bromide. Continuing the investigation of increasingly strained systems, this eventually led to his discovery of the carbene-carbene rearrangement, often referred to as the Skattebøl rearrangement^{[27][28]}.

Skattebøl obtained as expected spiro compounds from reactions of various alkenylated *gem*-dibromocyclopropanes with MeLi (Scheme 8, **1**). Substrates with decreasing number of CH₂ groups (*n*) in the chain between the cyclopropane and the olefin substituents would result in more strained spiro compounds and instead afford larger proportions of allenes. When *n*=2, the spiro compound underwent a thermal rearrangement to a triene through a biradical concerted mechanism. When *n*=1, the only product was the corresponding allene. When *n*=0, exposure to MeLi brought about a rearrangement which yielded cyclopentadiene. He used his findings to steer the reactions toward various tricycloheptane/-octane derivatives (Scheme 8, **1** & **2**), and cyclopentadienes, fulvenes, and their saturated equivalents (Scheme 8, **3**).

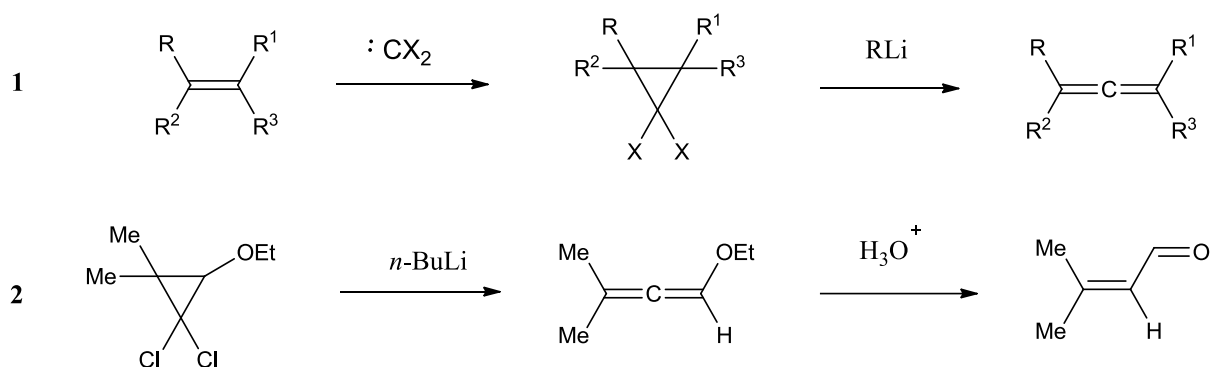

Scheme 7: General synthesis of allenes (**1**). Alkoxy allenes were hydrolysed to α,β-unsaturated aldehydes (**2**).

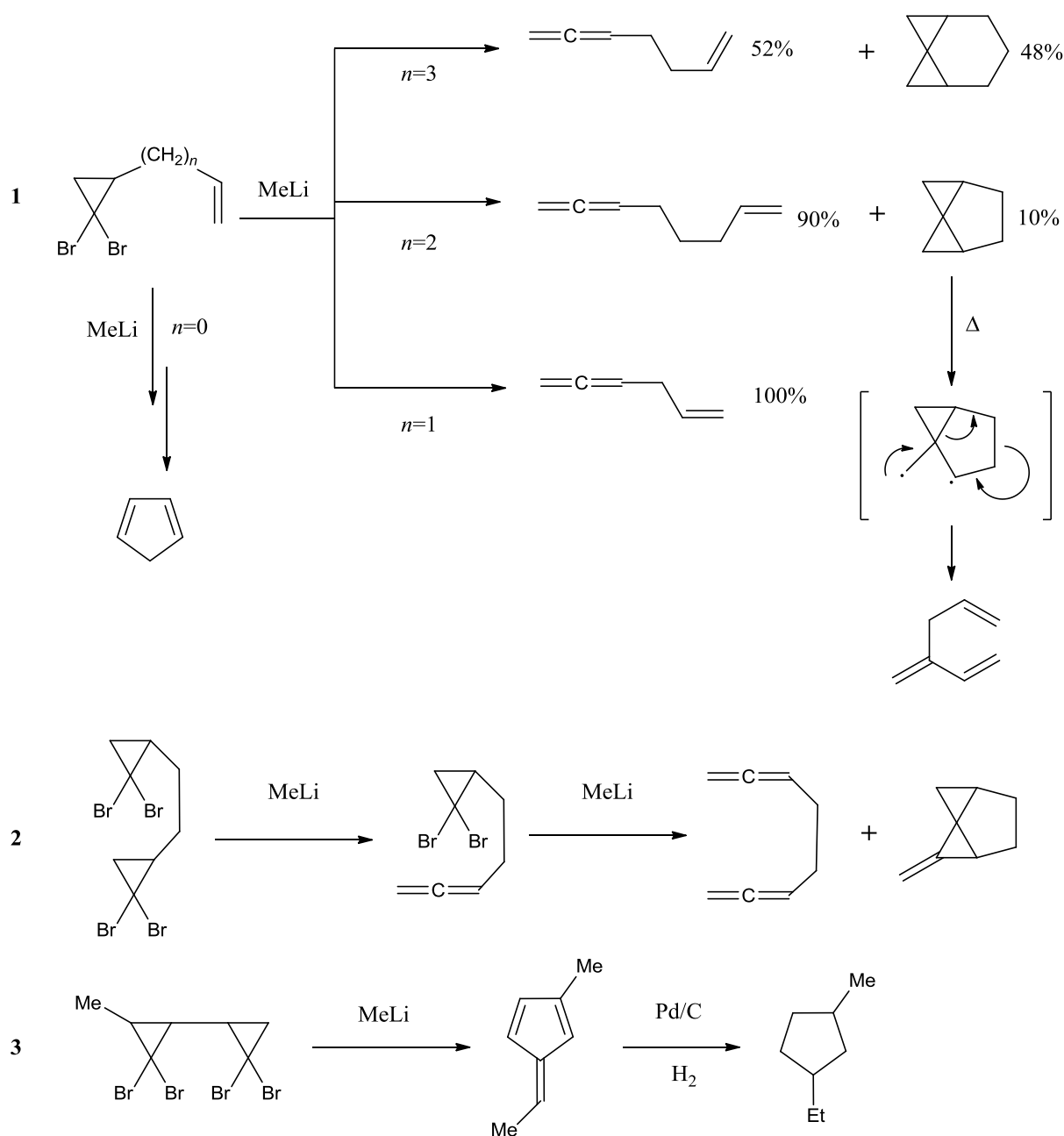

Scheme 8. From reactions of dibromocyclopropanes with alkyllithium, Skattebøl managed to control the reaction conditions to synthesize allenes^[23], tricycloheptane derivatives^[24] (**1** & **2**), and cyclopentadienes and fulvenes^[27] (**3**) in only a few of his projects.

This leads to the purpose of this study.

In the last decades Skattebøl's research group has attempted to build even more strained cyclopropanes. The strategy employed to go about this is to start with a cyclic compound and build a dihydrodioxane ring upon it, resulting in a bicyclic vinyl diether molecule (Scheme 9).

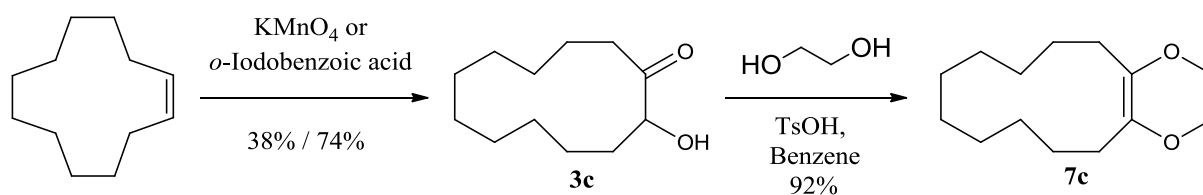

Scheme 9: Strategy for building bicyclic dihydrodioxins to which dihalocarbenes could be added.

Note that to the olefin are attached two oxygens coming from the same ring, a feature that is immensely useful and decisive for this investigation -the reason will shortly become apparent. It is obvious, however, that the oxygens in the six-membered ring make the π -bond particularly electron-rich and consequently more reactive to singlet dihalocarbene. Naturally, after addition of dihalocarbene a tricyclic propellane appears.

To investigate the effects of ring-strain, the size of the first ring was varied. This is analogous to Skattebøl's previous strategy where he investigated effects of decreasing CH_2 groups between two reacting groups in a chain, increasing strain (Scheme 8). This time, the investigation is on decreasing CH_2 groups in a ring that is part of a propellane system, increasing strain (Scheme 10).

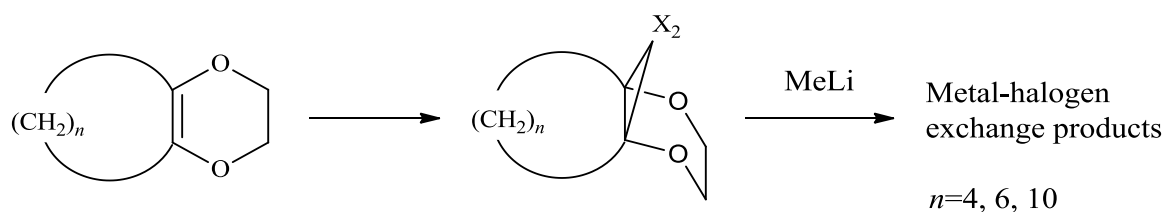

Scheme 10: Compounds of interest in the recent projects in strained molecule's chemistry.

The purpose of the study is to further investigate how ring-strain affects the chemistry of such dihalocyclopropanes, particularly with alkyllithium, and record their behaviors in comparison to the aforementioned results from Skattebøl. To understand why this is interesting, some characteristics need be observed:

- Firstly, the cyclopropanes in question would contain no hydrogens. This implicates that the mechanism of base-induced ring-opening by hydrohalo-elimination (Scheme 1, Pathway **B**) is not a possible one.
- Secondly, allenes as products of their reactions with MeLi are not expected. Perhaps the most interesting feature of these propellanes is that such strain is in fact expected to make them resist ring-opening, particularly into allenes.
- Finally, reduction of these cyclopropanes into their corresponding monohalides is regiospecific. Although their reaction with MeLi introduces a new stereogenic center, only one product -rather than a racemate- should be formed due to the presence of two oxygens in one of the rings. Indeed, the strong chelating interactions between oxygen and several metals are well documented^[29], and are the reason why a metal-halogen exchange is expected to undergo regioselectively at the bromine facing the two oxygens.

1.5 Previous work

Previously, the synthesis of some *gem*-dichlorocyclopropanes was embarked upon^[32] in order to do further investigations into Bakstad's ring-opening approach. When difficulties arose in the preparation of the precursory vinyl ethers, a splitting of projects was set: M. Sc. Yvette Luijkx attempted to investigate the ring-opening developed by Bakstad on a larger variety of cyclopropanes, while author's focus into Skattebøl's strained cyclopropanes project^[32].

1.5.1 Previous advancements in the chemistry of strained molecules

The ring-opening behaviors of propellanes have been studied by Skattebøl's and Bakstad's group. PhD student Jon Sigurd Sande studied the synthesis and ring-openings of *gem*-dichloropropellane of interest where $n=10$ with alkoxide bases in their corresponding alcohols. Based on Skattebøl's findings, normally *gem*-dihalocyclopropanes ring-open into their halovinyl acetals under such conditions through ring-expansion. Again, it was expected that the cyclopropanes in question behave differently as n decreases.

As explained by Sande^[31], the smallest cyclic molecule able to sustain an endocyclic trans double bond is an eight-membered one, and when $n < 4$ the result should be no reaction or a rearrangement. Even when the ring-openings are allowed for, differing products are expected for any instance where $n > 4$.

Sande reported quite thermolabile products -as was expected. By following up the ring-opening procedure with acidic hydrolysis by hydrochloric acid (HCl), he managed to arrive at a 2-chloro-1,3-diketone, proving that **17c** was formed in the reaction (Scheme 11). Because the hydrocarbon ring is large enough that it does not resist ring-opening, the two electron-donating oxygens provide enough energy to make ring-opening happen readily.

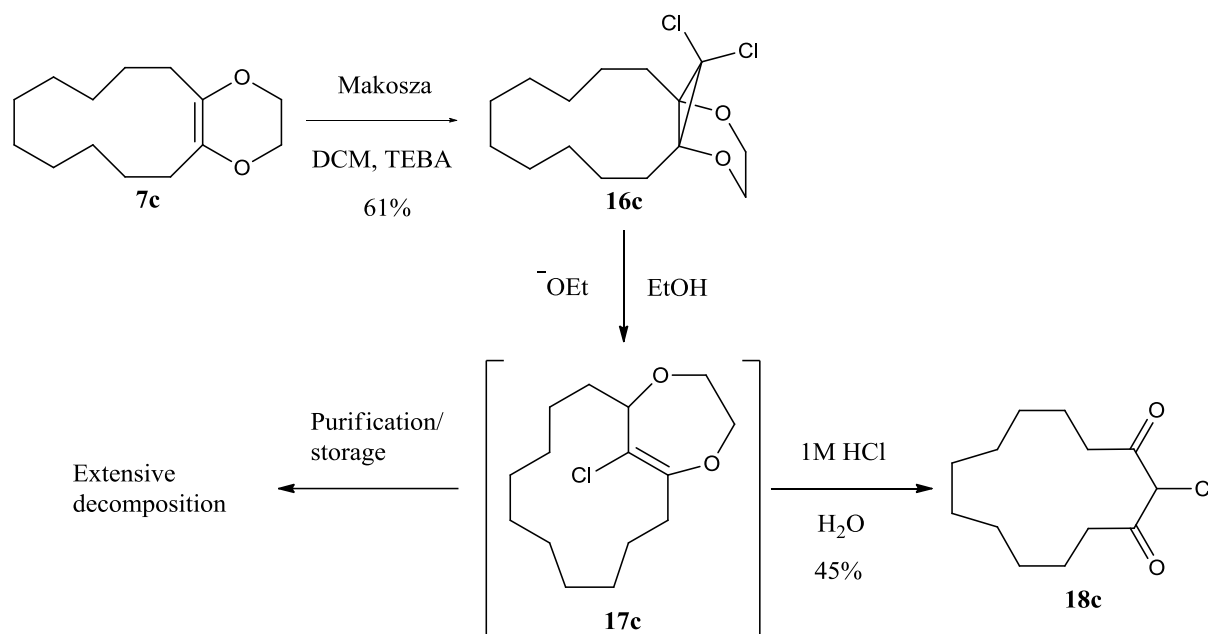

Scheme 11: Jon Sigurd Sande's results when investigating the nature of propellane **16c** ($n=10$). The products of carbene addition and ring-opening were thermolabile -which reflected in his yields.

M. Sc. Bjørn Erik Jønsberg investigated the behaviour of dibromopropellanes. Attempts at synthesizing the dibromo- equivalent **8c** failed, with the product spontaneously rearranging to acetal **15c**. He found that the classical procedure used for **16c** was unsuccessful with **8a**; The propellane likely resists ring-opening due its strained nature. Instead, he provoked a ring-opening to a different product by applying silver trifluoroacetate. Even this method did not work in the more strained version where $n=4$ (Scheme 12). Finally, reductions to the corresponding monobromides were reported with *t*-BuOK in tetrahydrofurane (THF), when $n=6$ & 4.

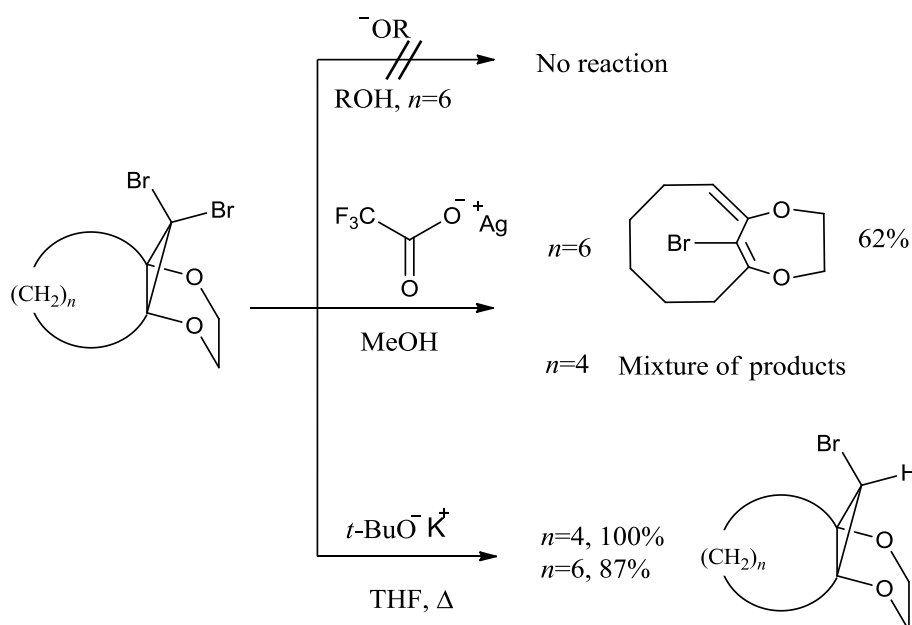
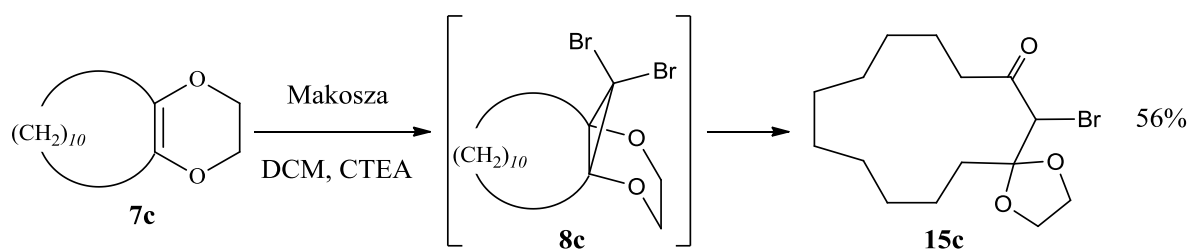

Scheme 12: Bjørn Erik Jønsberg's reports in the project.

Jønsberg also reported the propellanes' reduction to their corresponding monobromides with the help of *t*-BuOK in THF (Scheme 12). Such a reaction is to be expected with the help of alkyllithium, but not *t*-BuOK, especially when the reduction was regioselective, as it would be with the alkyllithium variant. However, upon repeating the reactions Sande reports no reduction of the propellanes into the monobromides. While he identified a few spectroscopic signals from new compounds, none matched Jønsberg's results and much unreacted starting material was left.

1.5.2 Preparation of starting materials -synthetic strategies

Skattebøl and Fjeldskaar have already described methods for the synthesis of the desired vinyl ethers. Their method involves the oxidation of a cycloalkene into their corresponding acyloins (Scheme 9)^[30]. Acyloins react with ethylene glycol in a cyclization to form the bicyclic vinyl ethers, releasing water twice in the process (Scheme 9 & 13). They also reacted acyloins with 2-mercaptoethanol and 1,2-ethanedithiol to give the oxathia- and dithia analogues (Scheme 14). In addition, the same reagents were able to react with dihydrodioxins to exchange the dioxane ring into the sulfur analogue, but these reactions sometimes afforded mixed bis-ketals, and other times adding to the double-bond once again to afford propellanes.

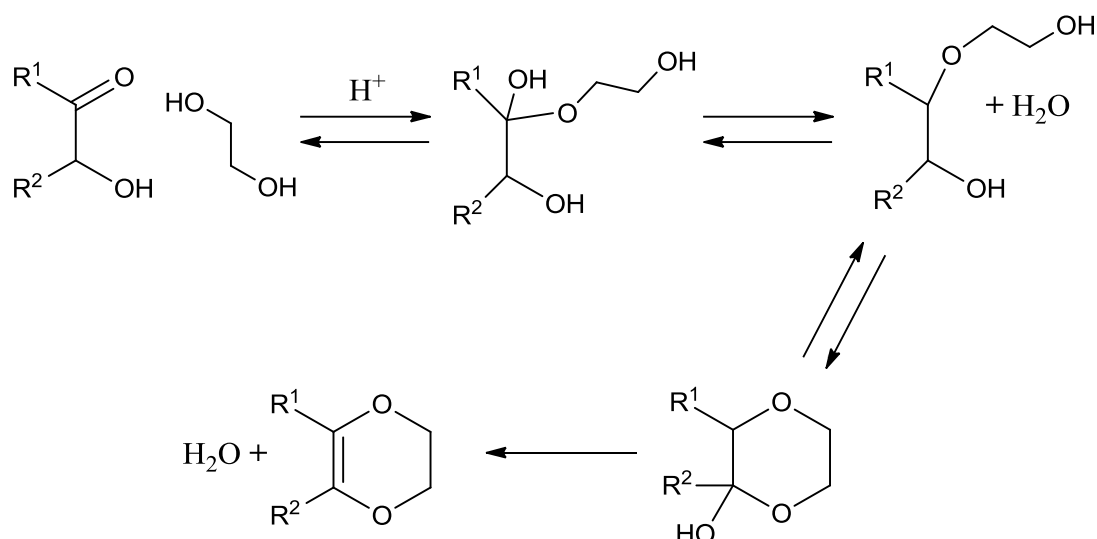

Scheme 13: Proposed mechanism for the formation of dihydrodioxins^[30].

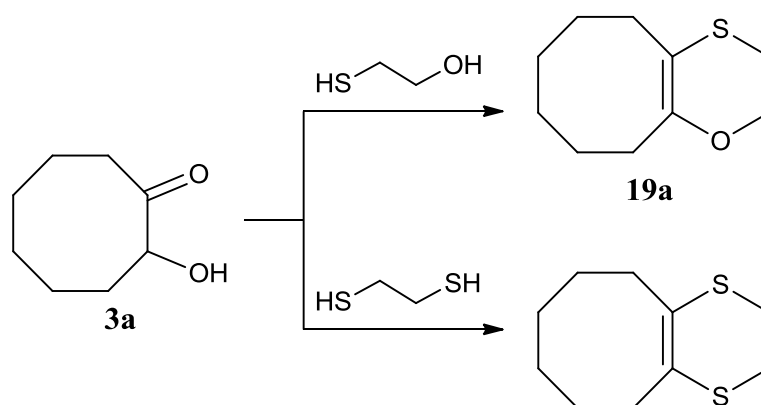

Scheme 14: Reactions of acyloins to yield oxathia- and dithia analogues.

The Bakstad research group picked up interest in this sequence due to their development of a new and simple acyloin synthesis that dates back to Bakstad's and former colleague Veslemøy Navrestad's work in the synthesis of a natural product. They found the preparation of acyloins quite challenging. This inspired Bakstad to eventually develop his own procedure which consists of heating α -bromoketones in a mixture of 50% DMF and 50% water. Obviously having applications in the sequence of Skattebøl's dihydrodioxin synthesis -in which the oxidation stage to the acyloin gave moderate yields-, Bakstad's following guest research scientist Rosalie Sanchez adopted the method to the project.

During her investigations, Sanchez came across several interesting findings. On one hand, she found that in the case of twelve-membered rings, she was able to skip the acyloin step altogether and form the dihydrodioxin directly from the bromoketone. On the other hand, her attempts arrived at different results in the case of the eight- and six-membered bromoketones. 2-Bromocyclohexanone reacted with ethylene glycol to give a bromoketal, and 2-bromocyclooctanone gave mixtures of unidentified products^{[1][47]} (Scheme 15).

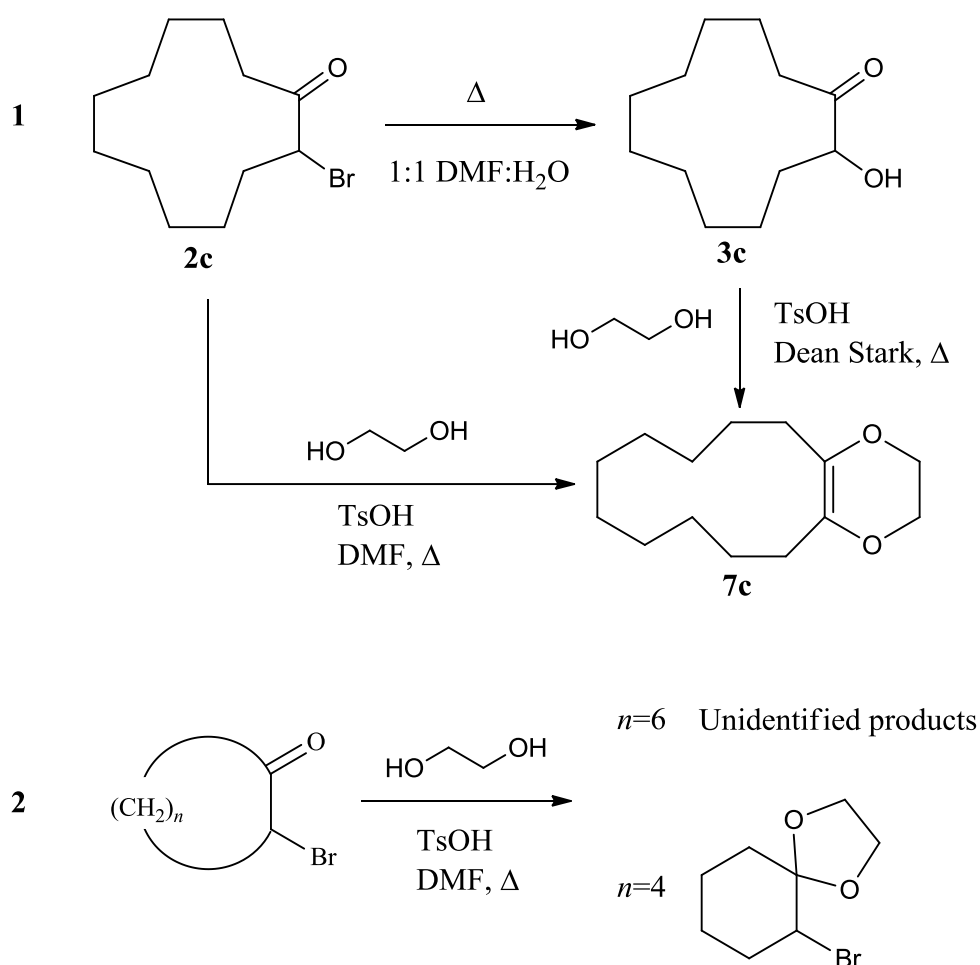

Scheme 15: Sanchez's results^[47]. Sanchez was able to transform bromoketone **2c** directly to vinyl ether **7c**. The same reaction respectively afforded bromoketals and unidentified products in the case of the six- and eight-membered analogues.

Finally, as Skattebøl's strained molecules' chemistry project was adopted^[32], a middle-point was found between his' and Bakstad's in the synthesis of dihydrodioxins derived from the same acetophenones as in Bakstad's project, rather than cyclic hydrocarbons/ketones.

The project was set to test Bakstad's as well as Sanchez's approach to synthesize dihydrodioxins, with focus on further testing the former's acyloin synthesis. Among the findings, two were of major relevance (scheme 16). First, α -bromoacetophenones all reacted with ethylene glycol to give bromomethyl ketals, analogous to the reaction of 2-bromocyclohexanone by Sanchez (Scheme 15). Secondly, acyloins did not themselves react readily with ethylene glycol; intense heating and large excess of reagents were needed to make any significant conversion apparent. This provided very interesting insights into the nature of these compounds and the reactions.

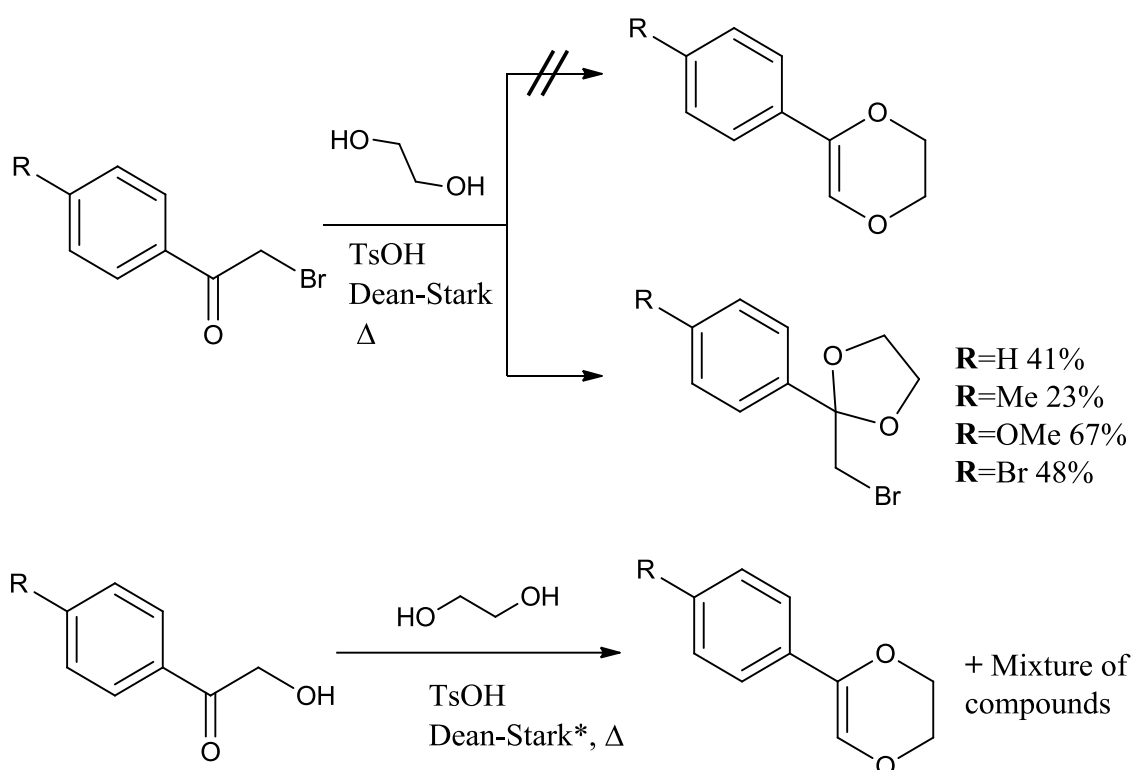

Scheme 16: Latest advancements in the project within Bakstad's research group^[32]. 2-Bromoacetophenones react with ethylene glycol to give bromoketals. Reactions of acyloins with ethylene glycol gave mixtures of compounds. *Changing of solvents to xylenes and addition of excess reagents gave marginal improvements.

Attempts at inducing rearrangements from the bromoketals to the dihydrodioxins gave unclear and complex spectroscopic results, but it is still theoretically possible. The fact that the acyloin-vinyl ether step does not proceed smoothly represents a challenge because there is already another problematic step in the sequence, namely the synthesis of acyloins.

Indeed, much of the work done in this field by Bakstad's group is done because the synthesis of acyloins, though simple, proceeds in only moderate yields. The main culprit responsible for this inconvenience is the surprising hydrophilicity of acyloins: the reason why Sanchez attempted to skip this step in the first place.

Though simple, clever, and possibly innovating, the acyloin synthesis developed in Bakstad's group has one main downside: so far, it has seen success mainly when using DMF as a solvent.

This solvent introduces a dilemma. On one hand, it allows the reaction to happen thanks to its very polar nature and particularly high boiling points. On the other hand, these very features make it difficult to effectively recover the acyloin. Removal of the solvent by distillation is practically always inefficient. DMF also tends to draw more of the acyloin into the water phase. As a result, the procedure typically yields 50-65% product, even when Thin Layer Chromatography (TLC) indicates complete conversion. Therefore, these dihydrodioxins cannot be expected to be formed in total yields far north of about 30%, depending of course on the substrates (Scheme 17).

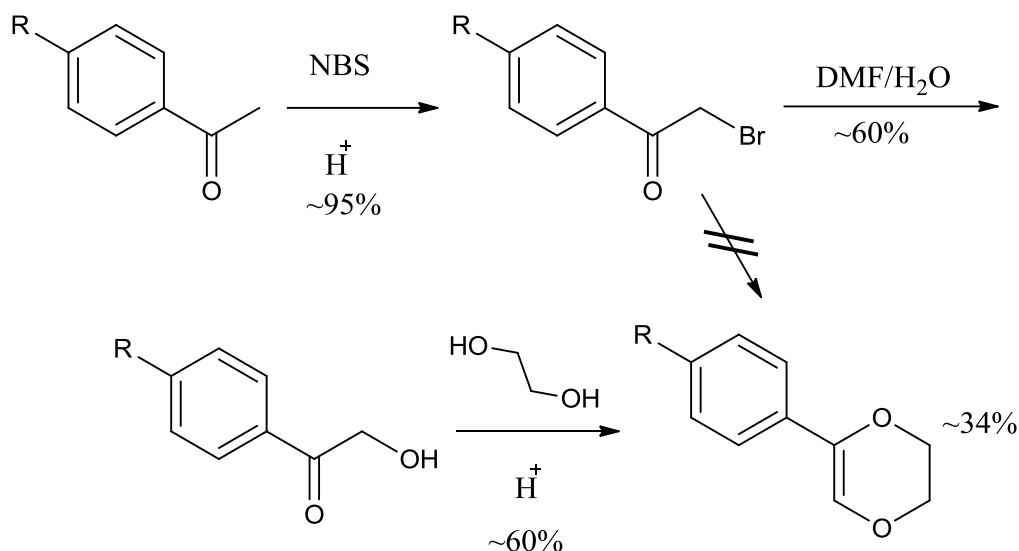

Scheme 17: General results of previous dihydrodioxin syntheses ^{[32][48]}. Though interesting results in the formation of bromoketals, overall these syntheses have been inefficient.

In light of this all, the present project was set in motion with two main purposes in mind:

- To attempt to complete this chapter of Skattebøl's 'chemistry of *gem*-dihalocyclopropanes' study by synthesizing *gem*-dibromocyclopropane **8a** and documenting its reactions with MeLi -this being the objective of most importance.
- To arrive at an effective and efficient method for the synthesis of acyloins.

2. Results and discussion

2.1 Preparation of vinyl ethers

Bakstad's approach to preparing acyloins is to stir α -bromoketones in a 1:1 mixture of water:*N,N*-dimethylformamide (H₂O:DMF) at 140° C. Said bromoketones are synthesized through a slightly modified version of a bromination method by Jong Chan Lee *et al.*^[33], which very conveniently works in outstanding yields. From experience^[32] it was known that some challenges needed to be overcome for the method to become relevant.

2.1.1 Investigation of the acyloin synthesis developed in Bakstad's group

The synthesis of some acyloins relevant for the investigation (**3a** and **3c**) was attempted. Though in practice the synthesis of acyloin **3c** was not needed as it is known that dihydrodioxin **7c** could be synthesized directly from bromoketone **2c** (Scheme 15), the twelve-membered analogue offers great opportunity as a starting point to better control this method because of its potentially higher lipophilicity.

Amongst attempts at using varying conditions such as other solvents and the addition of bases, the original method gave the best results. **3a** was prepared in 75% yield. **3c** was also prepared in 97%. Despite these yields, results were very challenging and impractical to reproduce.

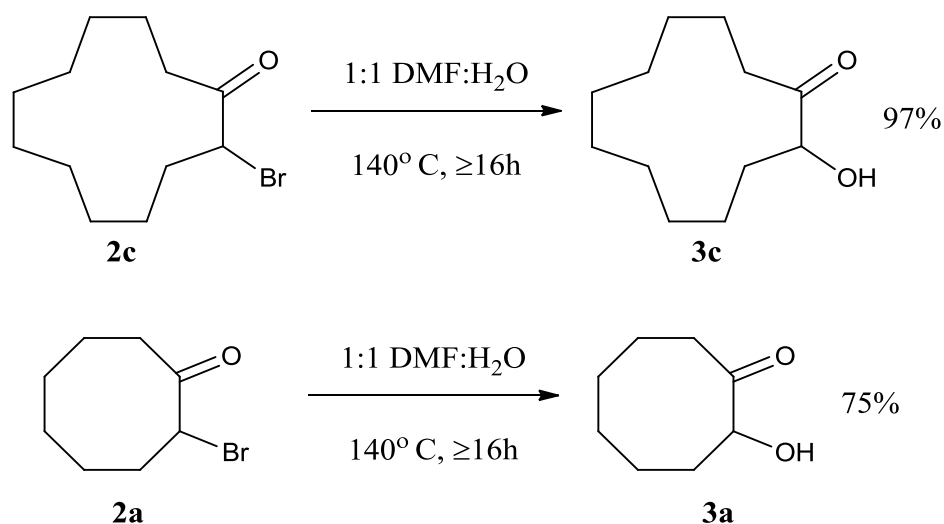

Scheme 18: Results from the acyloin synthesis method developed in Bakstad's group. Sanchez also reported relatively high yields of **3c** (85%) with this method^[47].

The same difficulties were apparent as with the acetophenone derivatives. Most notably, yields above 65% were difficult to obtain -even more to reproduce- due to the water solubility of the products. Attempts at better extractions by making the organic and water phases more polar were of no help. Among other experiments were the use of diglyme and dimethoxyethane (DME) as solvents. DME promoted no reaction between water and the bromoketone, likely due

to its low reflux-temperature. Lastly, the latter was repeated, this time adding small amounts of 1,8-diazabicyclo[5.4.0]-7-undecene (DBU), inspired by a successful conversion of 2-bromoacetophenone into the acyloin when DME and the base were used. None of these gave noticeable improvements.

There was a brief search for the azeotropic properties of DMF. DMF-heptane was the only azeotropic mixture found on the literature^[49]. The solvent was unavailable at the time, but this raised suspicions to the existence of other hydrocarbon-DMF binary azeotropes. Attempts at removing residual DMF from organic phases with methylcyclohexane were effective, but not at all efficient; it involved an arduous process of repeated rotatory evaporations at significant temperatures which consumed unproportionately large amounts of solvents and time. This approach was not successful.

Most of the time weights corresponded to more than 100% product, obviously indicating impurities. TLC generally showed quite slow conversion of the starting material. Reactions therefore stirred at 140° C for one or two nights, or more. It was noticed that several spots appeared on TLC and that this seemed to correlate to how long the mixtures were stirred under heat, results that extended also to attempts at azeotropic removal of DMF. Nuclear Magnetic Resonance (NMR) often revealed other unidentified products that attest to this. Yields were often unavailable for these reasons. These observations were difficult to document due to their inconsistency, which also made it rather evident that the method was impractical to perform with the available equipment.

2.1.1.1 Protection groups: α -benzyloxyketones

As the traditional method proved uncooperative, focus shifted to the synthesis of protected acyloins instead.

The synthesis of benzyl-protected acyloins was unsuccessful as none of the attempts gave any identifiable products.

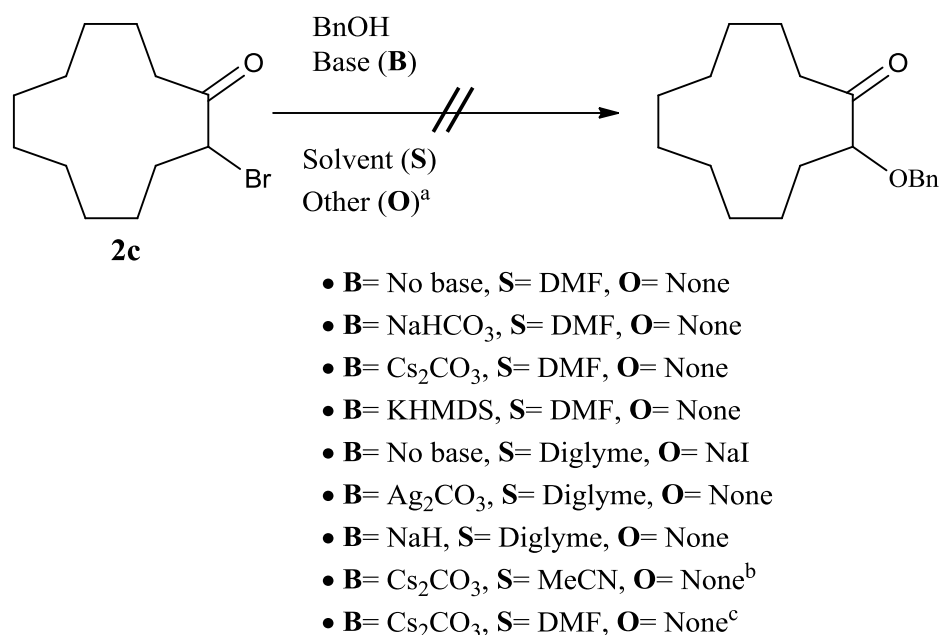

Scheme 19: Summary of results for reactions between bromoketones and BnOH. ^aWhen reaction was not apparent at room temperature (r.t.), the mixture was gradually heated.

^bStarting material was the iodoketone analogue of **2c**. ^cStarting material for this reaction was **2a**.

Initially, an analogue strategy to the original was employed: α -bromoketones were heated together with benzyl alcohol (BnOH) in DMF. This would result in a more hydrophobic product that should be more readily extracted. No conversions were apparent on TLC after heating in both DMF and diglyme. In the latter, an internal finkelstein was sought by adding one equivalent of sodium iodide (NaI). These efforts were to no avail.

Adding carbonate bases was tested next. It was thought that generating the benzyloxy anion in catalytical amounts or causing a stretching of the O-H bond would be enough to make benzyl alcohol more nucleophilic and promote a substitution with bromine. Upon addition of carbonates, mixtures were carefully heated if no conversion was apparent on TLC. Catalytical and stoichiometric amounts of sodium hydrogencarbonate (NaHCO₃), cesium carbonate (Cs₂CO₃), and silver carbonate (Ag₂CO₃) were tested in different solvents. Finally, sodium hydride (NaH) and potassium bis(trimethylsilyl)amide (KHMDS) were both used to produce benzyloxy anions *in situ*. These techniques also did not afford the desired products, but instead left behind complex NMR spectra due to profuse byproduct formation. As the strategy was fruitless, it was abandoned.

Interesting observations were made while testing these reactions. NMR showed complex mixtures of compounds, among which several carbonyl- as well as carboxylate carbons were identified.

A few processes could lead to such results. Initially, a type of Favorskii rearrangement-mechanism was suspected^[34] (Scheme 20). This could explain the acid/ester carbonyl signals as well as the apparent general abundance of products on ¹³C NMR.

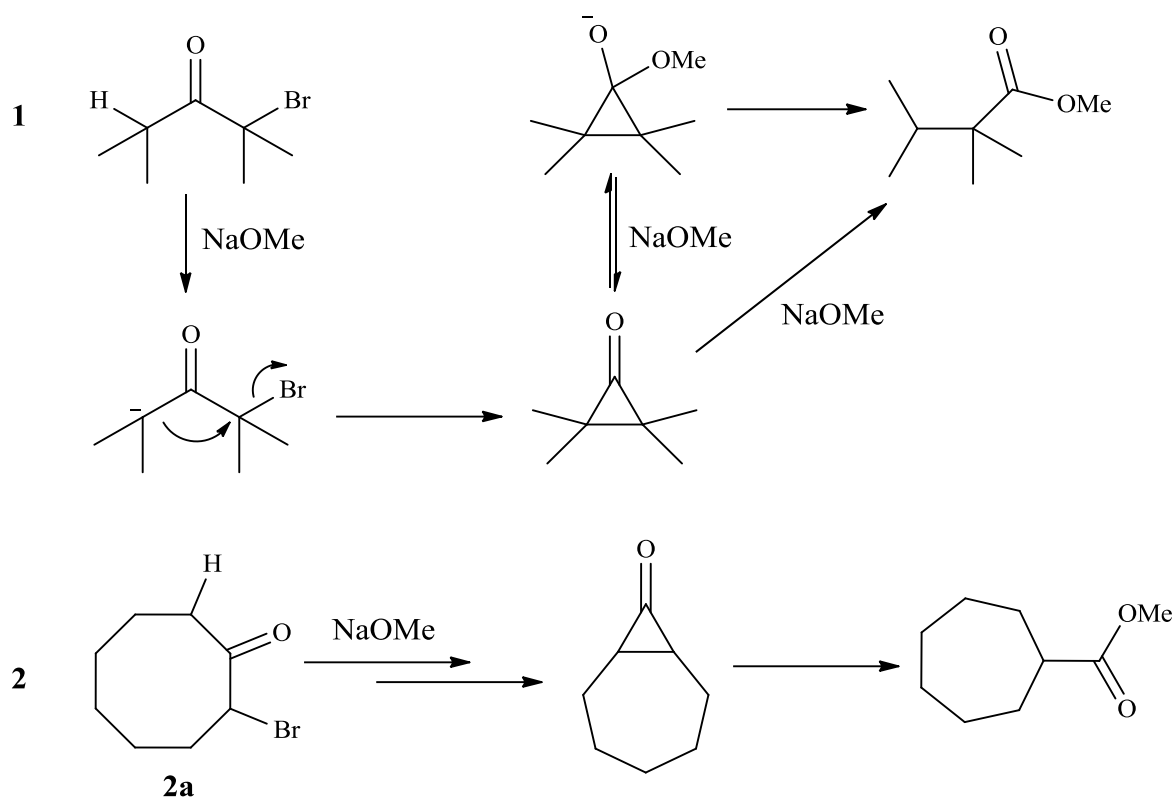

Scheme 20: General Favorskii rearrangement mechanism^[34] (1) and an equivalent reaction for **2a** (2). In reality, the end-result could be an exocyclic benzyloxy- or acid group, depending on the incoming nucleophile.

Further search on the literature eventually shed light on other processes that could have taken place. Leo Paquette has performed significant research in the acyloin front, as well as the behaviors of their protected ether relatives, including benzyloxy groups. He describes the α -ketol rearrangement as a 1,2-shift of a cyclic methylene group resulting in either ring-contraction or expansion^{[35][38]}. He also describes the base-induced O \rightarrow C 1,2-shift of alkyl and aryl groups in α -ketoethers, and their further ketol rearrangement in the case of cyclic compounds^[36] (Scheme 21). In fact, Paquette describes the basic ketol rearrangement of precisely 2-benzyloxycyclooctanone (Scheme 21), providing a near exact description of the chemistry attempted in this part of the study. David Curtin^[37] also explored the ketol rearrangement of alkyl ethers and experienced further reactions of the products, leading to complex product mixtures.

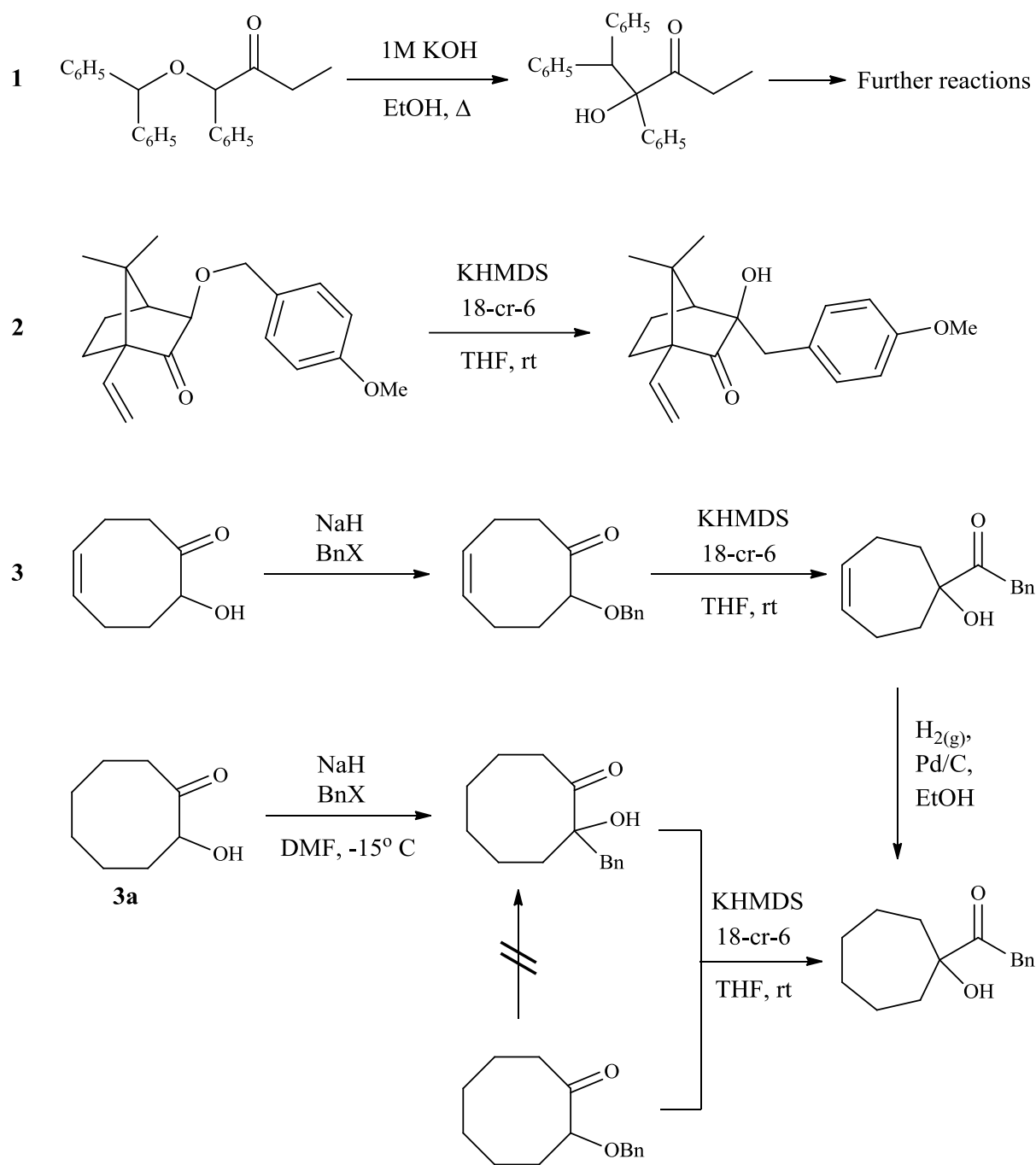

Scheme 21: Reactions explored by Curtin (**1**) and Paquette (**2** & **3**). Paquette found this useful when experimenting with the benzyl migration in α -benzyloxyketones in, for example, camphor relatives^[35] (**2**).

The likelihood exists that reactions of BnOH with **2a** and **2c** were in fact effective, and that the harsh reaction conditions prompted the resulting benzyl ether to undergo a basic ketol rearrangement. The possibility of further reactions as Curtin experienced (Scheme 21, **1**) should also not be ruled out. This could explain the emergence of several carbonyl signals as well as the apparent abundance of products on ^{13}C NMR.

2.1.1.2 Protection groups: α -acetoxyketones

Next, acetyl protections were explored. α -Acetoxyketones would be convenient as they can be converted to acylloins by simple solvolysis reactions. α -Acetoxyacetophenones themselves have been used in Bakstad's group previously, which makes this method promising.

The method was successful in the synthesis of α -acetoxyacetophenones **4e**, **4g**, and **4i**, but it unfortunately could not afford the cyclic analogues, **4a** and **4c**.

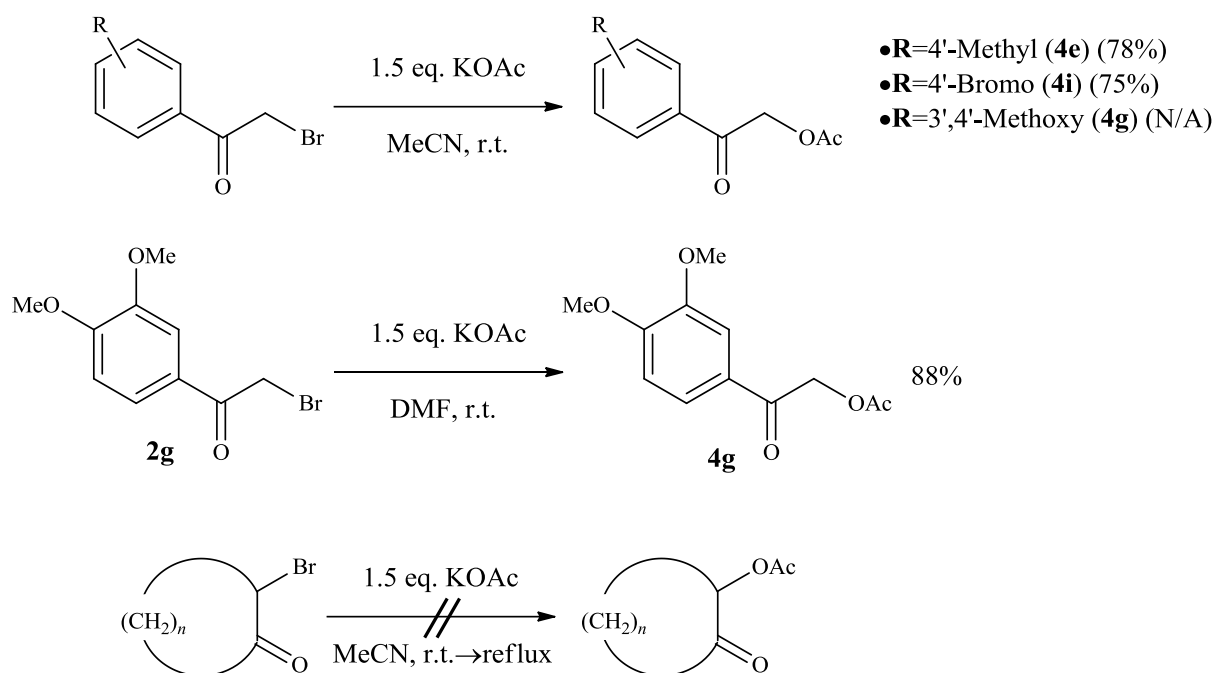

Scheme 22: Summary of results for substitution of bromides by acetate salts.

α -Bromoacetophenones were dissolved in acetonitrile (MeCN) and 1.5 eq. of potassium acetate (KOAc) was added. In some cases, conversion to the corresponding acylloins was hasty, whereas in other cases it seemed to stall. In the latter, adding significant excess of KOAc did not affect the progress of the reaction, as neither did heating to reflux. The reason for this stalling is unknown, but since the reaction seems to be controlled kinetically rather than thermodynamically it is of no help in this situation to allow these reactions to stir for long times and/or high temperatures, as was observed in the experiments.

The same conditions, save for DMF instead of MeCN as solvent, were then tested for the reaction of **2g**. The reaction proceeded quickly to completion within 2 hours, without the need for heating.

The same procedure was attempted for the cyclic α -bromoketones. Unfortunately, the acetophenone derivatives demonstrated their superior reactivity as the cyclic counterparts did not react even when heated with an excess of KOAc in MeCN. No evidence of conversion was seen when using silver acetate (AgOAc) as base or diglyme as the solvent. A similar thread has been followed before by Fung F. Wong *et al.*^[39], in a paper that describes the reactions of an abundance of α -haloketones with cesium formate (HCO₂Cs) to α -hydroxyketones in methanol.

It is suspected that the difference in results comes from Wong's use of more reactive conditions (Scheme 23).

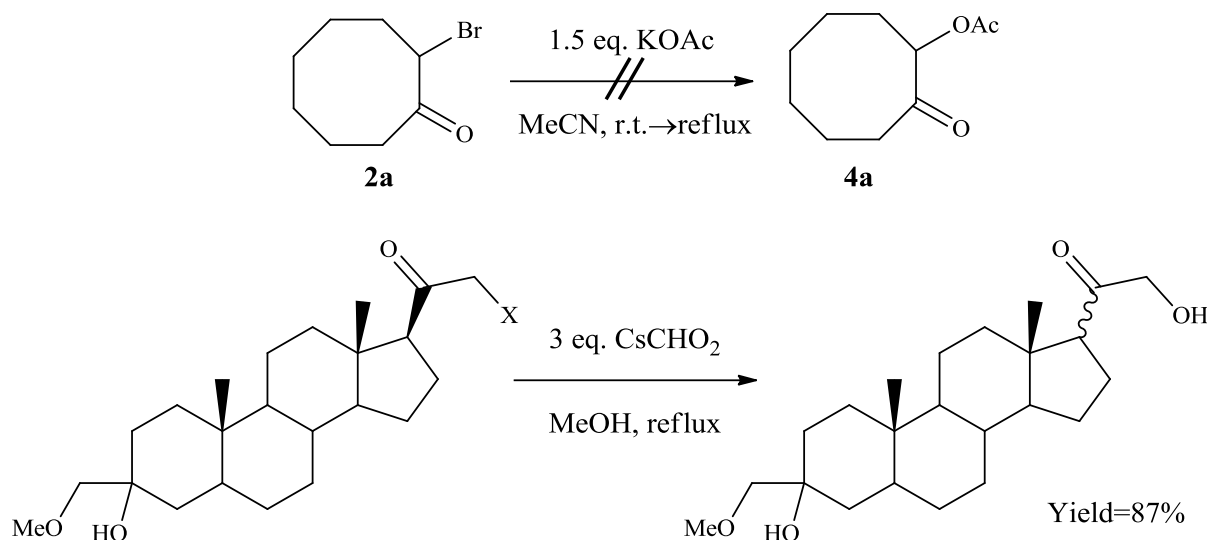

Scheme 23: Contrasting reactivities between the attempted reactions vs reactions of steroid equivalents into acyloins from Wong *et al.*^[39].

Methanolysis was the procedure of choice onward because of the easily accessible, low boiling solvent; high value was placed in the ability to bypass extractions from methanol (MeOH) as avoidal of back-extraction of product to the water phase was desired. When acetoxyketones were dissolved in MeOH together with catalytical amounts of sodium methoxide (NaOMe), TLC generally showed somewhat messy reaction mixtures with several polar products. This was accentuated when evaporation of MeOH was attempted, which also resulted in dark red-brown muds. The same was observed when stirring mixtures of bromoketones in KOAc under reflux for longer times. One cannot rule out a possible rearrangement of the type Paquette *et al.* described.

When acidic methanolysis was attempted with *p*-toluenesulfonic acid (TsOH), conversion was slower but nonetheless TLC showed cleaner mixtures. Acidic methanolysis was therefore preferred, but since basic solvolysis tends to be more effective in general, both reactions should be explored further.

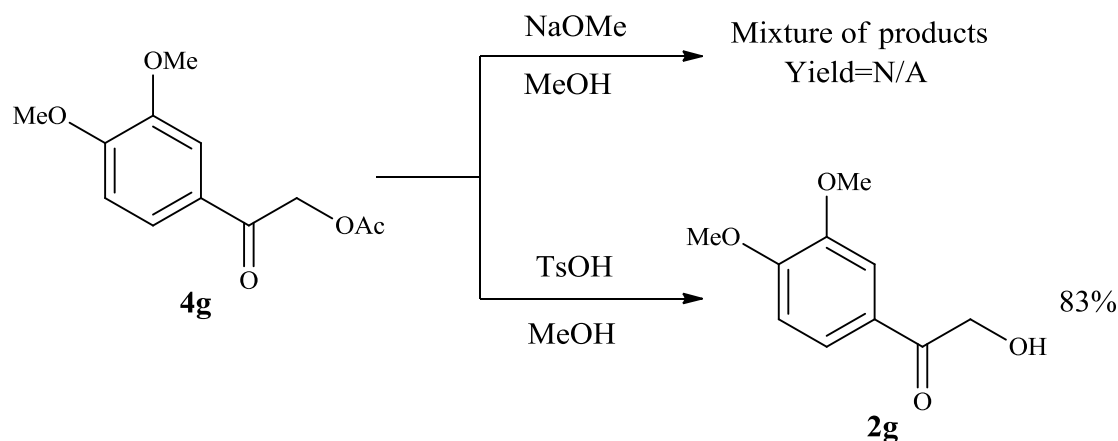

Scheme 24: Methanolysis with methoxide and acidic methanolysis, which was more efficient in producing acyloins.

2.1.2 Development of new methods: Oxidation of vinyl esters

When protection groups did not work as hoped, inspiration was drawn from other methods -in particular, the Rubottom oxidation. Although the research group had seen no extensive use in it before, it had seen success in the use of trimethylsilyl- (TMS) and trimethylsilyloxy- (TMSO) groups for different purpose.

The Rubottom oxidation^[40] comprises of the preparation and epoxidation of TMS enol ethers. Ring-opening of the epoxide results in an α -hydroxyketone. The procedure has been useful worldwide. However, it works best on relatively small-scale synthesis thanks to the base of choice, sodium bis(trimethylsilyl)amide (NaHMDS) and the relatively delicate TMS ether products. Growing interests in a new procedure were mustered by this as well as a possible analogue to the Rubottom reaction.

Such an analogue was seen in vinyl esters, which have been synthesized in the past with great success and published as part of a patent^[46] by Bakstad *et al.*. This carries the advantage of being able to prepare the starting-materials in large scale and without the need for dry conditions when compared to the traditional Rubottom procedure.

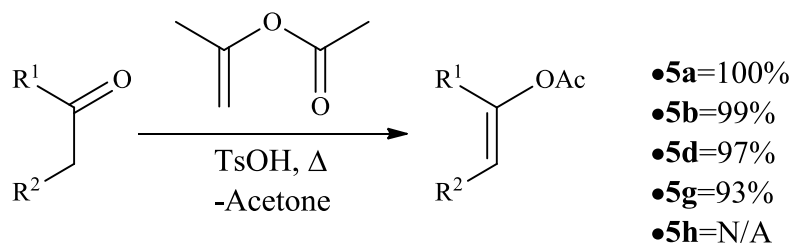

Scheme 25: Summary of results for synthesis of vinyl esters. The reaction seems to procedure quantitatively in a continuous distillation set-up even in larger scales, which in this case ranged from 100-500 mmol.

The large-scale synthesis of vinyl ester **5a** was successful in near-quantitative yields by heating the starting ketone **1a** in an excess of isopropenyl acetate -reagent and solvent- with the help of

and acid catalyst, producing acetone as a byproduct. The reaction proceeds to completion within a few hours thanks to the continuous distillation of acetone. TsOH monohydrate was the acid of choice.

The method was extended to ketone **1b** as well as acetophenones **1d**, **1g**, and **1h**. Acetophenones were perhaps too reactive; mixtures became darker and more viscous as they were heated for longer periods, hinting at polymerization. This was predominantly the case in reactions of **1h**. Although **5h** was obtained as the major product, yields were unavailable as the reaction gave a mixture of compounds. Should vinyl ester **5h** be synthesized with this method, protecting the *p*-hydroxy group *a priori* would likely give the best results.

Epoxidation of vinyl ester **5a** to novel epoxide **6a** was complete in a few hours as well. The traditional epoxidation method was employed, dissolving the starting material in dichloromethane (DCM) and slowly adding an epoxidating reagent, namely *m*-chloroperbenzoic acid (MCPBA). Reaction was apparent as *m*-chlorobenzoic acid precipitated from the solution.

Ring-opening of the epoxide was attempted in both basic (NaOMe) and acidic (TSOH) conditions, in both heptane and MeOH. Once again, it was found that acidic methanolysis was preferable in both solvents, as NaOMe brought about no reaction in heptane, and a messier product in MeOH. Heating the reaction mixture was also possible to urge product formation. Epoxides converted to acyloins with efficacy in this fashion, unveiling a new procedure for the synthesis of α -hydroxyketones. Although the method has been used before

It was realized that in this way, a conversion to dihydrodioxin **7a** directly from vinyl ester **5a** should be achievable, as similar conditions were needed for each step. What was essentially a one-pot-synthesis was attempted: dissolution of vinyl esters in DCM and addition of MCPBA, followed by the damping of the solvent and redissolving in MeOH, adding TsOH. The procedure was repeated, this time removing MeOH and redissolving in a toluene-ethylene glycol mixture in a Dean Stark apparatus. With this method, full conversion from vinyl esters to dihydrodioxins was effective in one day in a total yield of 67%. The emergence of the benzoic acid and methyl benzoate relatives did not interfere with the reaction.

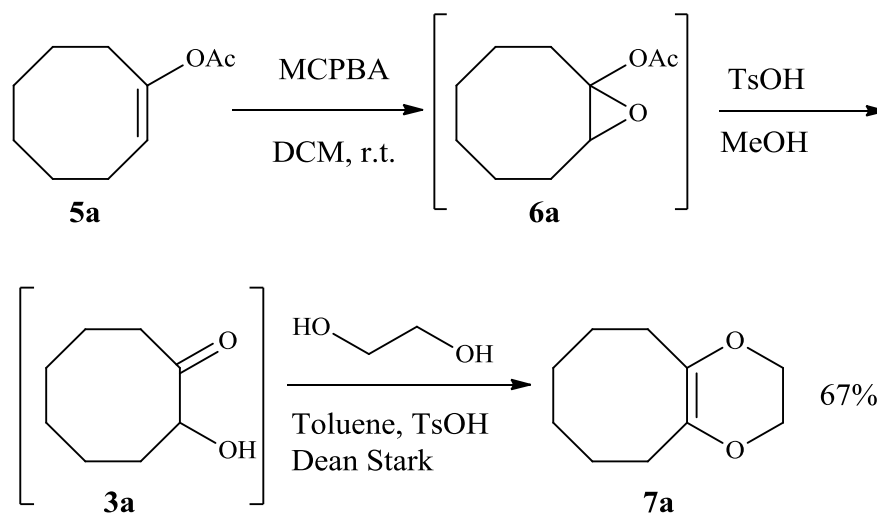

Scheme 26: Synthesis of dihydrodioxins. **7a** was synthesized in much larger scales than was achievable in previous methods (100 mmol) and a total yield of around 67% with only minor presence of methyl *m*-chlorobenzoate.

This method turns out to be excellent for quantitative production of acyloins and dihydrodioxins. However, the present investigations required that value be placed on qualitative production as pure compounds are essential to proceed any further into investigations of strained molecules' chemistry. This became a challenge mainly because of the methanolysis step. *m*-Chlorobenzoic acid reacted also with MeOH to give the corresponding methyl benzoate. These two byproducts were carried on to the latest stage, complicating purification of dihydrodioxin. In this, the procedure needed optimization due to residues of *m*-chlorobenzoic acid/ester impurities.

Alternative epoxidation procedures were considered, such as a bromination in water, which should earn an α -halogenated hemiacetal. If such a compound could be isolated, subsequent treatment with a non-nucleophilic base, such as NaH could promote epoxidation by departure of the bromide. NMR showed conversion of **5a** into a new product, likely the predicted hemiacetal, but it also showed considerable decomposition into **2a**. This method requires working with the toxic elemental bromine as well as careful work-up to prevent decomposition of the hemiacetal, so it was dropped in favor of efforts to better control the MCPBA epoxidation.

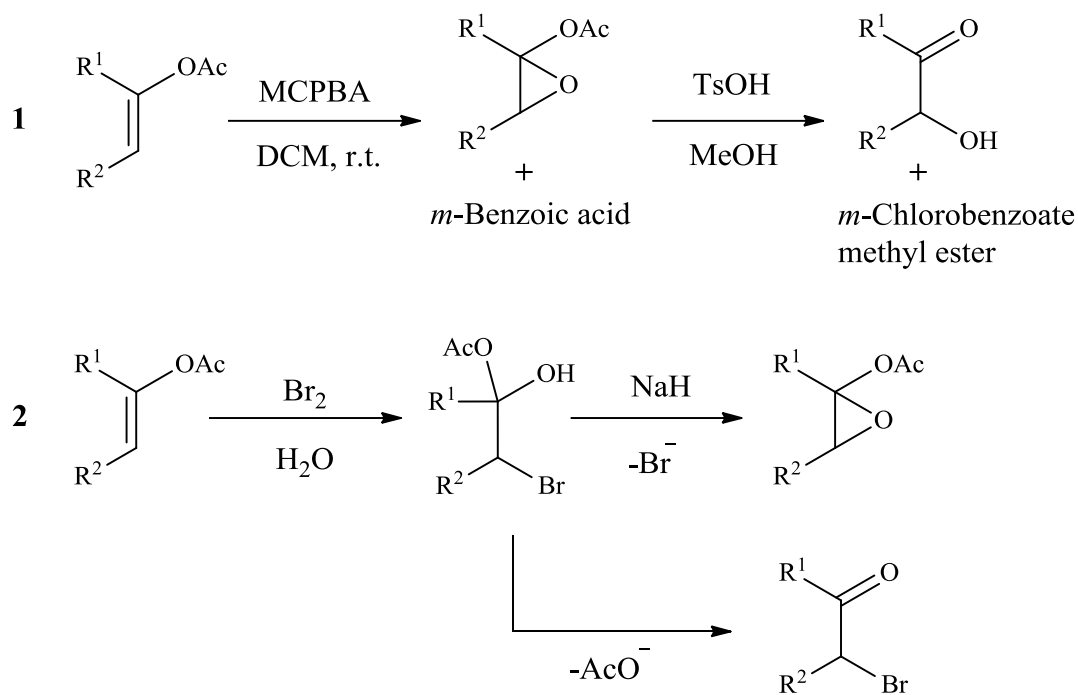

Scheme 27: Disadvantages of the MCPBA epoxidation method (**1**) and disadvantages of the bromination in water (**2**) method.

Dry Flash Chromatography (DFC) was ineffective at removing large amounts of the benzoic acid/ester byproducts. This was largely alleviated, but not eradicated, by filtration of the post-epoxidation reaction mixture as is traditional for epoxidations with MCPBA. Attempting to isolate the acyloin by DFC was also of little help, resulting often in reduced yields of the product and the occasional presence of benzoic acid as well as the generation of several other byproducts. Post-DFC crudes of the acyloins at times did not react with ethylene glycol at all.

In the pursuit of hydrolysis of the methyl benzoate ester back to the carboxylate, crude dihydrodioxins were dissolved in heptane and added large excess of aqueous and solid sodium- and potassium hydroxide (NaOH and KOH), followed by extraction with heptane. NMR showed reduced amounts but still presence of the ester, in addition to lower yields of dihydrodioxins.

It was crucial that riddance of the byproducts be done before the methanolysis step to prevent formation of the methyl benzoate byproduct, which complicates purification processes. Filtration under reduced pressure removed a large fraction of *m*-chlorobenzoic acid. Changing of the solvents to diethyl ether (Et₂O) allowed for the washing of the acids from the ether phase with the help of potassium carbonate (K₂CO_{3(aq)}). It is possible that this process could ring-open some of the epoxide into the acyloin, allowing some product to be lost to the water-phase. The procedure was then performed as usual, and purifying the final crude product by DFC afforded pure vinyl ethers.

2.1.3 Synthesis of vinyl ethers

Dihydrodioxins **7a** and **7b** as well as their oxathia-relatives **19a** and **19b** were prepared in this method.

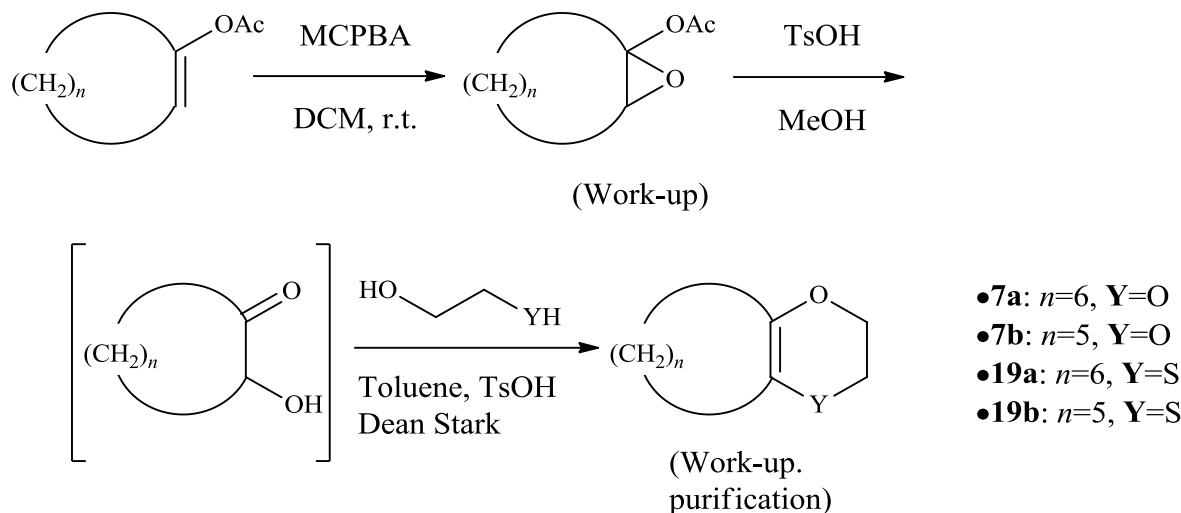

Scheme 28: Summary of the finalized synthesis of vinyl ethers.

As a result of the novel method, a few note-worthy observations on the dihydrodioxin step were made.

The reaction was found to proceed faster and in higher yields when ethylene glycol was added in large excess rather than stoichiometric amounts, even when the reaction mixture is in fact largely two-phased. This was first noted under the investigations of possible DMF azeotropes: significantly more water would be removed azeotropically under the synthesis of vinyl ethers than was accounted for by stoichiometry and crystal water in the acid. Usually, this was attributed to environmental moisture. However, it was found that toluene in fact forms an azeotrope with ethylene glycol^[49]. A few experiments where carefully heating the reaction mixtures to just under their azeotrope temperature, 110.2° C, showed significantly diminished distillation of water while achieving smooth conversion. When ethylene glycol was added in significant excess and the mixture refluxed, the Dean Stark set-up trapped larger water phases. Taking into account that benzene and ethylene glycol are zeotropic, this could be part of the reason why the reaction seems more efficacious in benzene than in toluene.

In addition, reactions seemed to undergo more smoothly when acyloins were delivered in better quality. This difference was noted when reacting acyloins from epoxidation contra substitution of bromine with water, since no impurities except for the benzoic acid-by-products seemed to build-up with the former.

In general, acyloins were reacted with ethylene glycol in very good yields as apparent from TLC, but due to the nonnecessity to isolate them no yields were recorded. DFC of the crude allowed for the isolation of pure vinyl ethers that could be used for the next step: dibromocarbene addition.

2.2 Emergent applications

2.2.1 Novel synthesis of 1,2-diketones

A novel method for the synthesis of 1,2-diketones was found in the epoxidation and subsequent ring-opening of 2-Bromo-1-acetoxylvinylcycloalkanes. 1,2-Cyclooctadione (**26a**) was synthesized in this way.

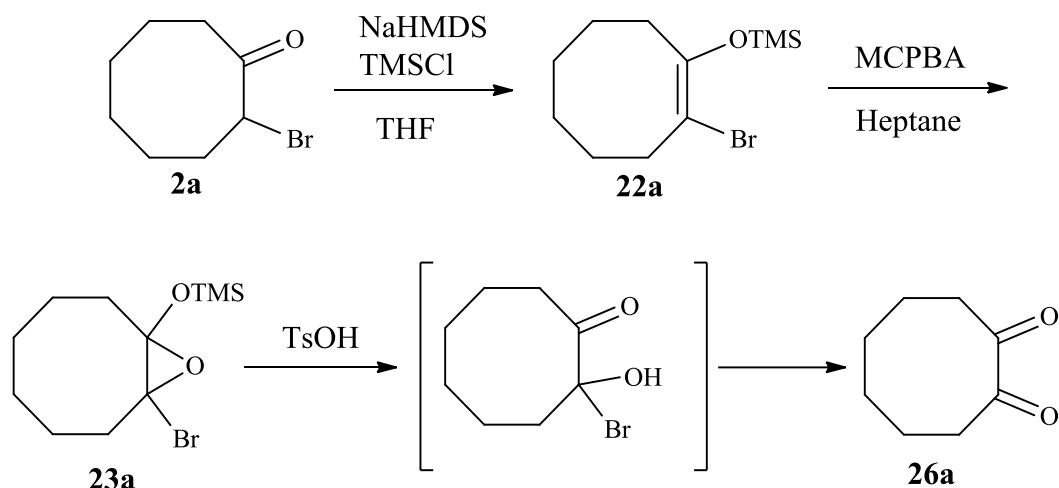

Scheme 29: Novel synthesis of 1,2-diketones to afford diketone **26a**. Yield was not available due to the presence of other compounds.

When new ways to produce acyloins were discovered, cyclic α -bromoketones were abandoned. The question arised of whether or not these could be put through the same or similar reaction conditions to the Rubottom based acyloin synthesis. It was realized that this would in theory yield a geminal bromoalcohol. This should easily decompose by releasing bromide, and the result would be a 1,2-diketone.

To the best available knowledge, such a procedure was not described. Most often, they involve oxidations with metals and complex catalysts, many of which tend to be inefficient as they tend to produce a mixture of both oxidation stages, namely acyloins and diketones (Scheme 30).

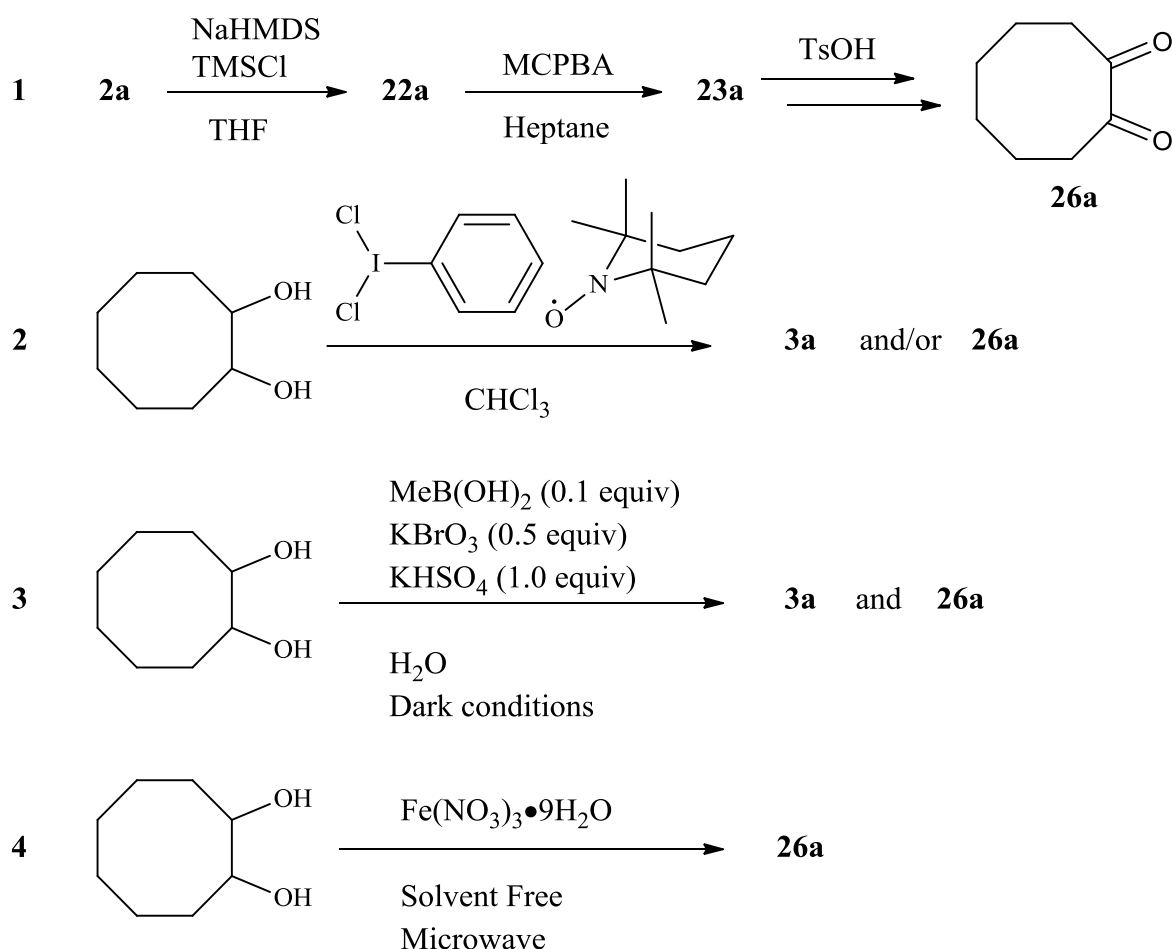

Scheme 30: Present synthesis of diketone **26a** at r.t. without the need for complex, toxic or expensive metals and catalysts (**1**) of which other methods often make use, such as Zhang *et al.*^[41] (**2**), Onomura *et al.*^[42] (**3**), and Ganesan *et al.*^[43] (**4**).

When α -bromoketones were heated with TsOH in isopropenyl acetate, no reaction took place.

Once again, the original Rubottom oxidation was considered. Analogous to the preparation of **21a** with TMS chloride (TMSCl) and NaHMDS in ether, the reaction of **2a** with TMSCl in the same conditions underwent fully. It was found that epoxidation of TMS enol ethers requires very cautious addition of MCPBA, much in contrast to epoxidation of vinyl ethers where addition of large amounts of MCPBA (around 20 g in a single reaction vessel) was possible.

The product was the expected novel compound **22a**. A second product accompanied **22a** in quite small amounts. This is thought to be the corresponding isomer **28a**, resulting from competition of a second, minorly contributing enolate structure (Scheme 31). The spectroscopic characteristics that made its presence evident are ^1H NMR triplets at 3.75 and 1.86 ppm and minor ^{13}C NMR peaks at 148.7 and 107.0 ppm.

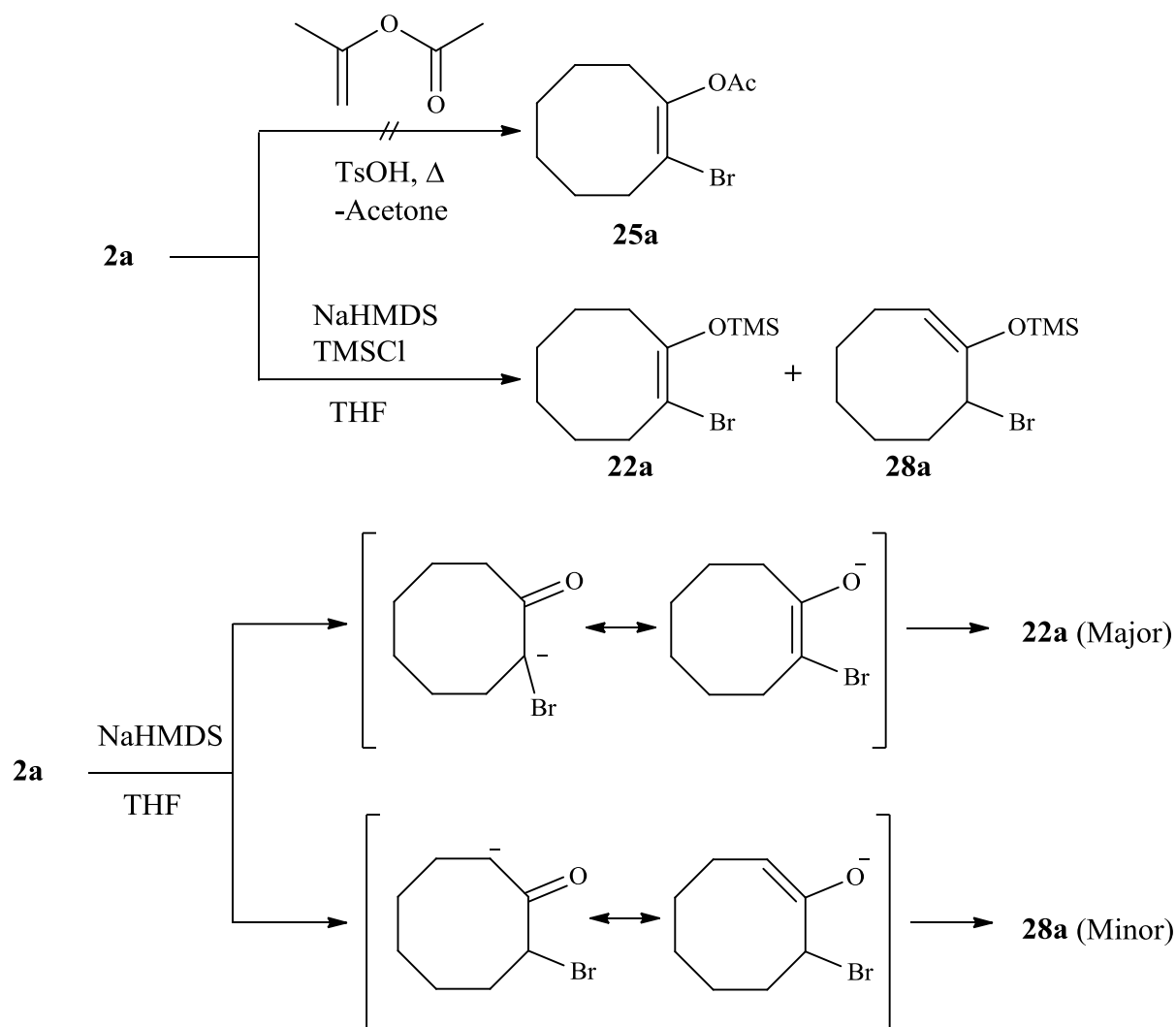

Scheme 31: Reactivity of **2a** towards isopropenyl acetate and TMSCl (**1**). Formation of **22a** was seen together with possible isomer **28a**.

Epoxidation of the compound in DCM and heating the resulting crude in DME and TsOH, followed by dissolution in Et₂O and washing the resulting organic layer with K₂CO_{3(aq)}, was successful in producing 1,2-cyclooctanone (**26a**). The same was achieved in a simpler manner by epoxidation of the olefin in heptane, followed by addition of TsOH when the reaction appeared complete. Filtration of the precipitate and washing of the supernatant with K₂CO_{3(aq)} yielded the same results.

NMR showed the consumption of all starting materials, in each instance. In the last stage, 1,2-cyclooctanone was identified in the NMR spectra. **2a** was also evident in significant amounts. Additional signals also showed, quite interestingly, the likely presence of epoxide **23a**. This renders the assumption that the epoxide should ring-open readily not entirely true. In retrospect, the generation of **2a** must come before the oxidation stage, so it could be explained by early decomposition of **22a**.

Rubottom-type oxidations were able to afford 1,2-diketones by using α -bromoketones instead of ketones as starting materials. ¹³C NMR showed the presence of **26a** as well as what is likely its precursory epoxide **23a**. In addition, significant amounts of **2a** seem to have been regenerated.

This procedure has great advantages which include the use of relatively mild conditions, no catalysts except for acidic ring-opening of the epoxide, and in particular no metal catalysts whatsoever. If this procedure could be steered towards full conversion of the epoxide and regeneration of the bromoketone prevented, it could be an excellent competitor for syntheses of 1,2-diketones. More research should be done on this front.

2.2.2 Applications in Bakstad's ring-opening investigations

As a result of the novel acyloin/vinyl ether synthesis, simple and economic access to large amounts of enol esters could not be ignored. Their potential role in carbene chemistry was exciting. Though not part of the main objectives, the addition of dibromocarbene to these olefins was briefly explored. As per in section 1.2, such cyclopropanes can undergo an electrocyclic ring-opening to afford ring-expanded α,β -unsaturated ketones upon attack by a nucleophile.

Acetoxy-substituted *gem*-dihalocyclopropanes can also be of interest for Bakstad's ring-opening applications. Under those reaction conditions, it is suspected that hydrohalo-elimination will be preferred and directly afford an acetylenic ketone. It should be recalled from section 1.3 that these compounds can be extremely potent in synthesis, for example as Michael acceptors and Diels-Alder (DA) substrates.

A comparable approach was exploited by L. Sydnes and Bakstad^[44] to arrive at the same product.

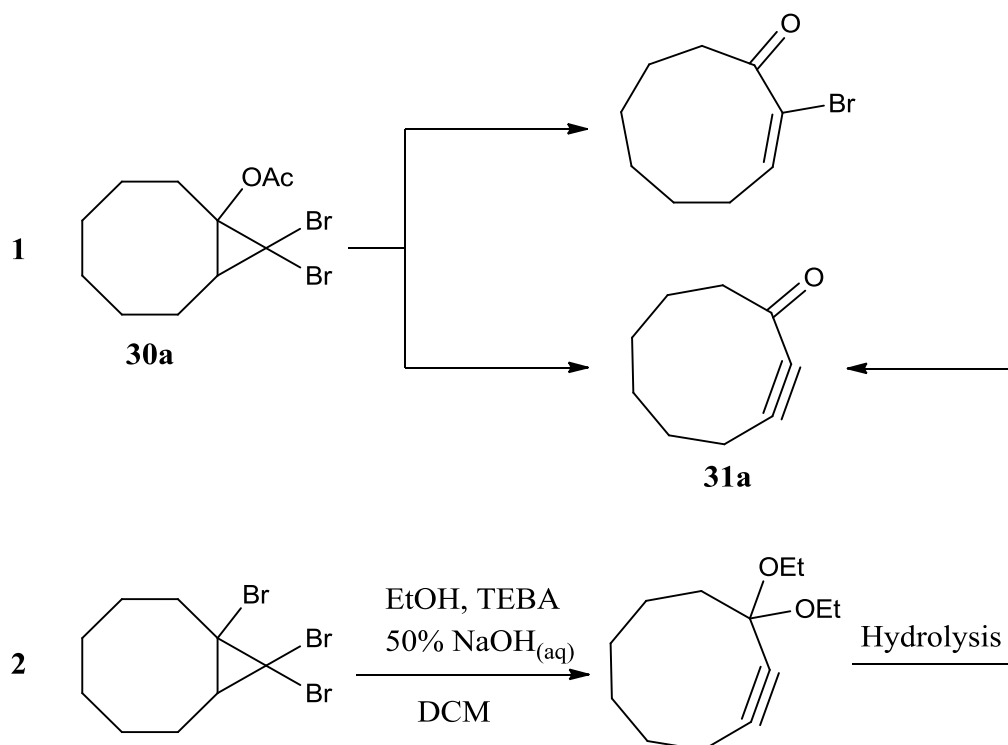

Scheme 32: Possible steering of the ring-opening of 2-acetoxy-1,1-halocyclopropanes to directly afford acetylene ketone **31a**. Bakstad has already prepared such cyclic acetylenes with a similar method^[44].

The Doering-Hoffmann method caused some of the vinyl esters to decompose to the corresponding ketones prior to addition of bromoform, which could be resolved by reverse addition of the reagents: culminating with addition of the base instead of bromoform. This was not an issue with the Mąkosza method, but it did have the down-side of often leaving behind unreacted vinyl ester.

5a reacted with dibromocarbene and generally afforded the dibromocyclopropane, and **5b** reacted to form a mixture of the equivalent and ring-opening products. The reaction could be partly steered by acidic work-up to afford more of the cyclopropane or alkaline work-up to afford more ring-opening products. Still in every case a mixture that was difficult to characterize was obtained. Some ^{13}C NMR peaks thought to correspond to the cyclopropanes were 66.3, 39.4, and 21.2 ppm (**30a**), and 68.7, 40.1, 21.2 ppm (**30b**).

This line of research is interesting and merits further exploration. If this should be done, focus should be placed on preparing the more stable *gem*-dichloro equivalents, which would give more room to manipulate the reaction conditions.

2.3 Chemistry of strained *gem*-dibromocyclopropanes

2.3.1 Preparation of strained *gem*-dibromocyclopropanes

Dihydrodioxins **7a** and **7b** reacted with dibromocarbene to afford propellanes **8a** and **8b** as the sole products. Oxathia- analogues were also reacted with dibromocarbene with the same procedure to give novel propellanes **20a** and **20b** (Scheme 33).

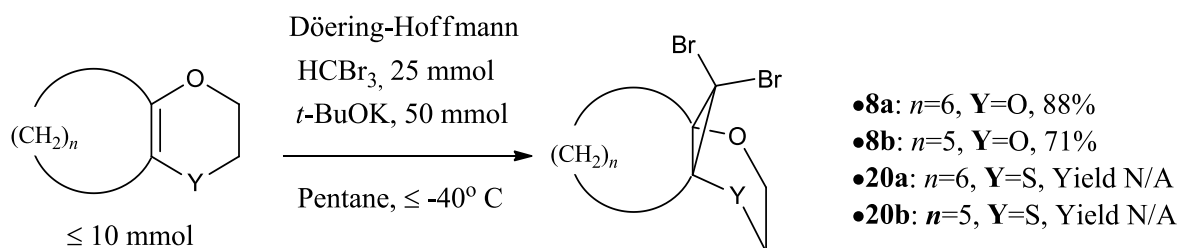

Scheme 33: The Doering-Hoffmann method worked excellently in every aspect.

The Mąkosza method often left unreacted starting material when allowed to react overnight, while the Doering-Hoffmann method converted all starting material within 4 hours of stirring at -40°C or lower. Another advantage of the latter method was the nonnecessity for traditional work-up. Instead, the reaction mixtures were filtered through celite and the solvents removed under reduced pressure.

The oxa-thia analogues should afford a 1:1 mixture of two isomers. Although all starting materials appeared to be consumed to produce the corresponding propellanes as suggested by spectroscopic analyses. Yields were not obtained for the reaction due to the presence of other compounds. This made it difficult to obtain all spectroscopic values of the compounds, but some of their characteristics were identified (Scheme 34).

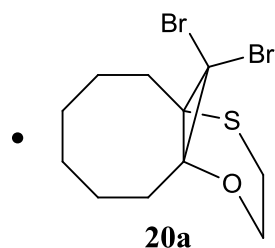

$R_f=0.64$ (20% EtOAc in heptane). IR (neat): 2972, 2927, 2855, 1459, 1151, 1086, 805 cm^{-1} ; $^1\text{H NMR}$ (400 MHz, CDCl_3): N/A; $^{13}\text{C NMR}$ (100 MHz, CDCl_3): δ 62.8, 62.5 ppm.

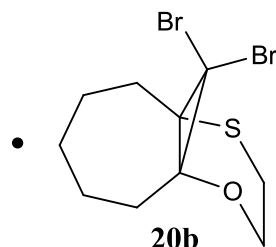

$R_f=0.52$ (20% EtOAc in heptane). IR (neat): 2972, 2887, 1381, 1087, 1045, 879 cm^{-1} ; $^1\text{H NMR}$ (400 MHz, CDCl_3): N/A; $^{13}\text{C NMR}$ (100 MHz, CDCl_3): 62.9, 62.5 ppm.

Scheme 34: Available characteristics of **20a** and **20b**.

2.3.1 Reactions of *gem*-dihalocyclopropanes with methyllithium

Reactions of **8a** and **8b** with methyllithium (MeLi) were recorded.

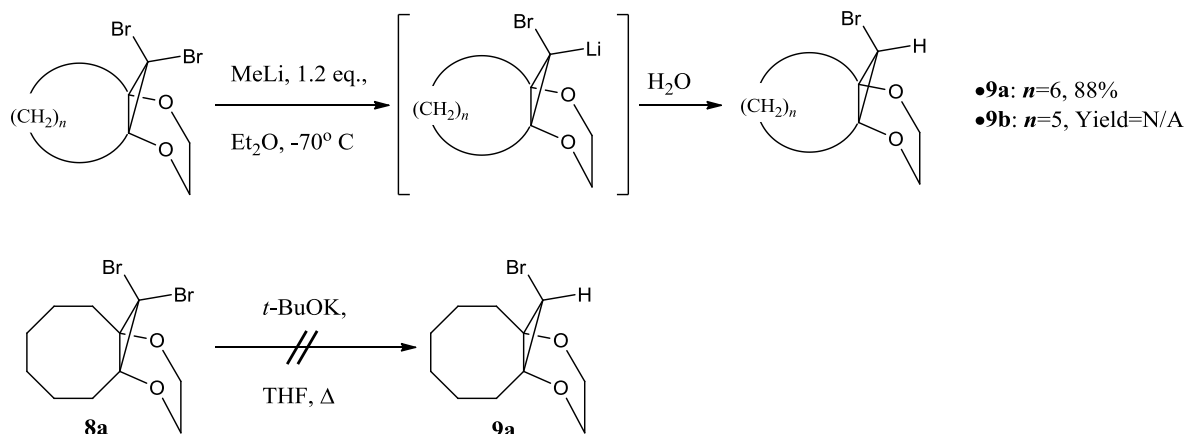

Scheme 35: Results for the reduction of dibromopropellanes to monobromopropellanes with MeLi. Dibromopropellanes did not react with *t*-BuOK as Jønsberg has described.

Following general procedures by Skattebøl^[24], when **8a** was dissolved in dry ether and permitted to stir for 30 minutes with an ethereal solution of MeLi at -70°C , followed by quenching with water, NMR showed that all starting material was consumed. Although the reaction is expected to go to completion nearly instantaneously, unreacted **8a** was left over when quenching after five minutes from addition of MeLi.

What was more interesting was that the product had spectroscopic data that were inconsistent to those of BSc. Øyvind Ulset^[48], who reported diagnostic peaks that coincided with Jønsberg's.

That is not to say the results were inconsistent -on the contrary, repeats of the same reaction afforded very consistently products with identical properties as shown by NMR. A single sole

product with spectra very similar to those of the original dibromocyclopropane was seen. The only exception to this was the ^{13}C NMR signal of the brominated carbon, which shifted significantly in ppm from 46.9 for the dibromocyclopropane to 31.8 for the monobromocyclopropane. The product displayed a general upfield shift in ppm by about 0.2. This result being always accompanied by the 15 ppm shift of the halogenated carbon, as well as NMR spectra of incomplete reaction mixtures, is evidence to the reduction of the starting material **8a** to monobromide **9a**. No traces whatsoever of the ^{13}C NMR peaks reported by Ulset -64.8, 60.0, 40.1, and 19.5 ppm- were found.

9a Also showed a general up-field shift in its ^1H NMR spectra compared to the starting material, and most notably revealed a new singlet as was expected. Once again, this singlet -appearing at 3.64 ppm just upfield from two multiplets- did not coincide with Jønsberg's stated chemical shift of 3.87 ppm. The same was repeated for **8b**. Despite the presence of unreacted starting material, the resulting NMR showed very similar shifts in ppm.

A repetition of Jønsberg's reduction procedure was sought. It was found that **8a** does not react with *t*-BuOK in THF at r.t., although immediate color change was observed upon addition. Another attempt was performed, this time heating the mixture to reflux for 30 minutes, but still no reaction took place. This agrees with Sande's results on the same reaction.

In order to gather more evidence of having produced the reduced compound, an isotope-labeling experiment was performed by quenching with heavy water (D_2O) instead. The bromolithium compound should couple with deuterium to afford **10a**. ^1H NMR revealed the same proton signal (3.63 ppm), but this time with significantly reduced intensity relative to the rest of the signals. Repeating the reaction gave each time precisely the same results.

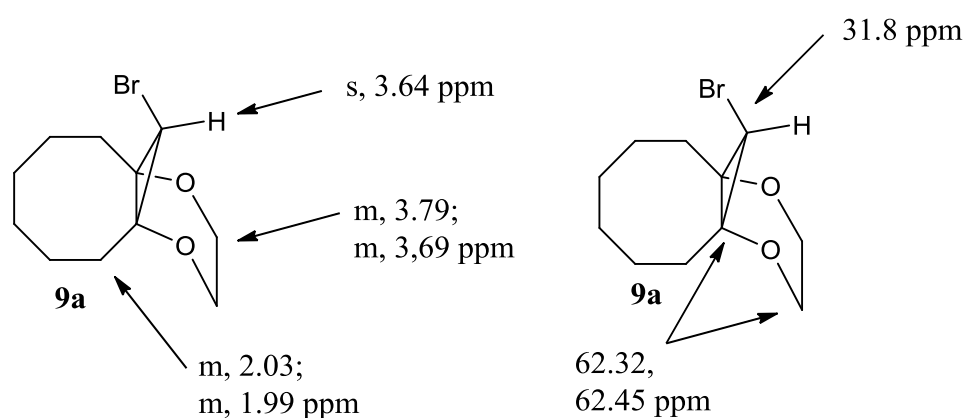

Scheme 36: **9a**'s ^1H NMR (left) and ^{13}C NMR (right) characteristics of interest in CDCl_3 .

It was expected that most any electrophile should react in the same way as water could. Benzyl bromide was used to quench the reaction mixture next. The new benzylated cyclopropane **11a** should exhibit no singlet to indicate a proton on the cyclopropane ring, just as **10a** should. For unknown reasons, this coupling was not apparent. Instead, NMR showed peaks coinciding exactly with the ones found before for **9a**, including the singlet at 3.64 ppm with the same relative intensity as when quenching was performed with water. Starting material **8a** was also present in the spectrum. Although no aromatic signals were found on the spectra, a new

compound was noticeable in the mixture's NMR spectra. The spectroscopic characteristics that could be obtained from spectra of the mixture follow: ^1H NMR (400 MHz, CDCl_3): δ 4.03-3.99 (m), 3.98-3.95 (m) ppm; ^{13}C NMR (100 MHz, CDCl_3): δ 64.5, 32.8.

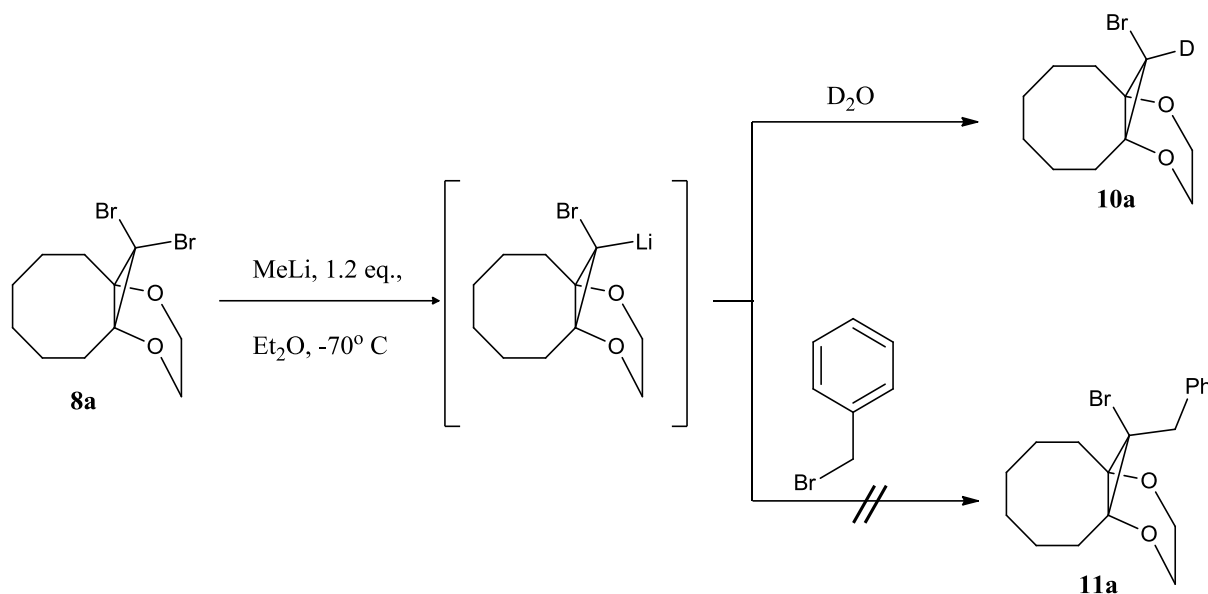

Scheme 37: Quenching with D₂O gave evidence of reduction of to the monobromide. An analogous reaction with benzyl bromide did not work as expected, and instead gave **9a** as product.

Finally, the generation of a carbene by elimination of lithium bromide was desired. It was suspected that simply allowing the mixture to rise to room temperature should promote the formation of the cyclopropylidene. To prove this, trapping experiments were set up. When dibromide **8a** was reacted with MeLi and thereafter allowed to rise to r.t. in the presence of ethylvinyl ether, no reaction was found: NMR spectra of the product showed only starting material **8a** after the reaction. This was a puzzling result as it implied that MeLi did not react with the cyclopropane at all. It is also known that ethylvinyl ether is fairly reactive towards carbenes^[1]. This experiment therefore merits repetition, together with the electrophile interception experiments.

A carbene insertion to THF -a well known reaction- was attempted. This was promoted by using THF as the solvent and allowing the mixture to reach r.t.. Intramolecular examples of this reaction have been performed by Skattebøl^[45]. Once again, no evidence of a coupling with THF were found. However, a reaction was evident as no starting material was found, but instead a different product, again with similar spectroscopic properties. The reaction was attempted again, this time heating the mixture to 50°C for 30 minutes after allowing to gradually rise to r.t.. The resulting NMR spectra were identical.

Since insertion into THF had clearly not taken place, a reaction of the substrate with itself was the only likely circumstance. This carbene dimerization resulting in two cyclopropanes coupled by a double-bond. Because of the expected orientation of the generated carbene, only one compound with complete symmetry is expected here, namely **14a** (Scheme 38). This would not be the only possibility. It is plausible that yet another cyclopropylidene can react further with **14a**, resulting in a spiro compound as was explored in section 1.4 and further. In fact, the product would be a triple spiro compound. However, for this to happen steric hindring effects

from the other propellane rings would have to be surpassed. Although Stereo-electronic repulsion between dioxane rings may help direct the reaction towards one of two possible products, a mixture of two compounds would still be expected from the addition of cyclopropylidene to cyclopropane dimer **14a**. NMR of the product suggests that the former is the product formed due to the symmetry of the compound.

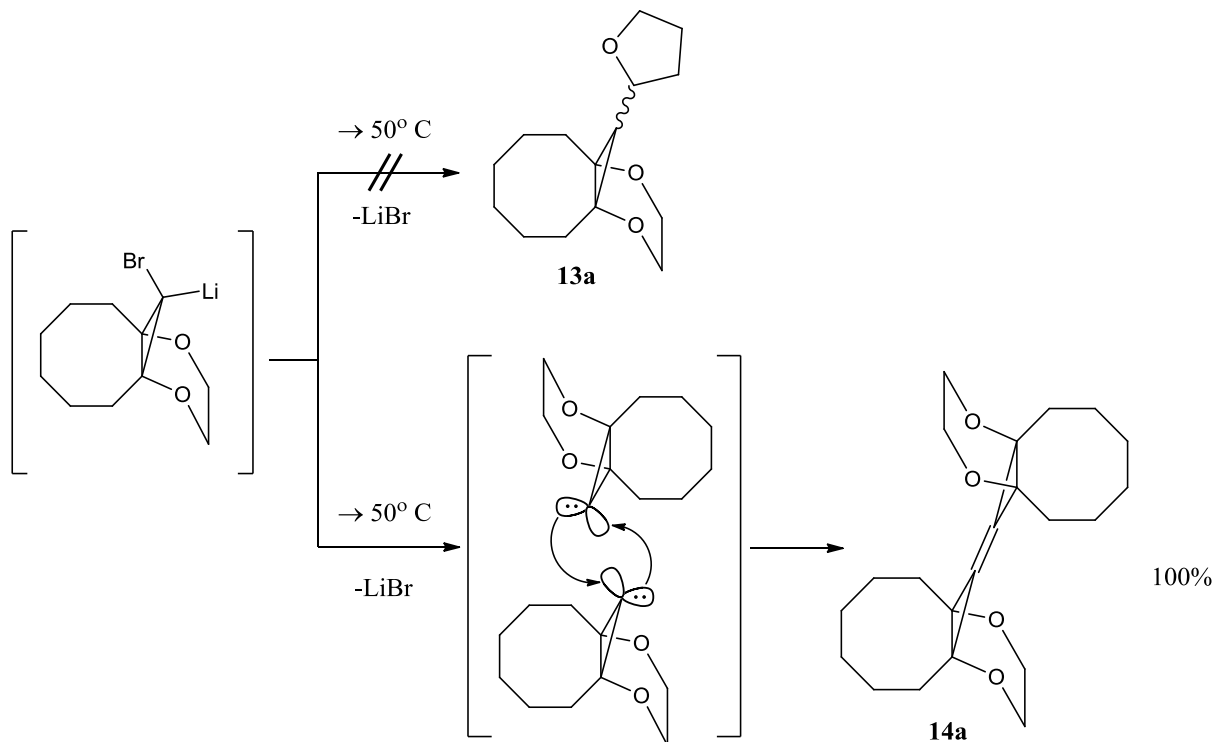

Scheme 38: Attempts at trapping a carbene by insertion to THF as explored by Skattebøl^[45]. Instead, the likely product was **14a**, the result of a dimerization.

It is considered that the generation of a carbenoid is enough for a dimerization reaction to occur. The favouring of dimerization contra THF-insertion could be accounted for in this way, as the bromolithium carbenoid would be able to dimerize long before temperatures were high enough to generate a carbene that was able to perform insertion.

It is interesting that the chemical shift of the olefinic carbons should be so similar to the dibromocyclopropane monomer's, at 45.72 and 46.9 ppm respectively. The amount of **14a** obtained, which was pure according to NMR, also corresponds exactly to 100% of the dimer, but mass spectrometry analyses are needed to disclose this as well as the presence/lack of bromides in the reduction reactions. IR and raman spectroscopy will also provide important information regarding the presence and nature of the olefin fragment in the dimer. Results for Raman and MS of the MeLi reaction products are pending.

3. Conclusion

During this study, novel compounds **5g**, **5h**, **8b**, **9a**, **9b**, **10a**, **14a**, **19b**, **20a**, and **20b** were synthesized.

Strained dibromopropellanes **8a** and **8b** were prepared from dihydrodioxins **7a** and **7b** in very good yields by the Döering-Hoffmann method without the need for traditional workup.

MeLi was found to react with efficacy with dibromocyclopropanes **8a**, and **8b**. The bromolithium compounds were intercepted with H₂O to give only the reduced products: monobromides **9a** and **9b**, respectively. Although the product was found to have different spectroscopic characteristics than previously reported, it can be concluded with confidence that the present are the true properties of monobromide **9a**, which makes these the first descriptions of the compound to the best knowledge. In agreement with MSc. Sande, dibromide **8a** did not react with *t*-BuOK in THF.

Intercepting the bromolithium compounds with D₂O gave both **10a** and reduced amounts of **9a**, as implied by the significantly lower intensity of the singlet at 3.64 ppm but otherwise identical spectroscopy. The alternative reaction of benzyl bromide surprisingly did not work as expected and afforded instead **9a** and starting material. This reaction should be repeated as it is still thought to be possible.

Generation of the cyclopropylidene of **8a** and its addition to ethylvinyl ether to produce **12a** was unsuccessful; starting material was isolated instead. The cyclopropylidene's insertion into THF was attempted. Remarkably, dimerization of the carbene to yield dimer **14a** was consistently favoured over insertion reaction to yield **13a**. As of the submission of this paper, results for mass spectrometry and Raman spectroscopy of **8a**, **9a**, **10a**, and **14a** are pending.

Several α -hydroxyketones were synthesized using different methods.

Acyloins were produced in three steps from ketones by a method previously undescribed and independently developed throughout this study. Respective conversion of ketones **1a**, **1b**, **1e**, and **1g** to enol esters **5a**, **5b**, **5e**, and **5g** was quantitative even in large scales, but polymerization happened in the case of acetophenones, especially before conversion of **1h** to **5h** was complete. In this case, protection of the *p*-hydroxy group will most likely improve results. Epoxidation of **5a** and **5b** was also very effective, and methanolysis of the resulting acetate epoxides **6a** and **6b** readily afforded acyloins **3a** and **3b**. Yields for the latter two steps were unavailable but evidently rather good.

This method was also useful in preparing pure dihydrodioxins **7a** and **7b** in three steps without the need for isolating the respective acyloins **3a** and **3b**. The procedure also does not require the isolation of epoxides and therefore allows for large-scale two-step synthesis of acyloins or dihydrodioxins in quite good total yields. Emerging challenges in this case are the removal of the resulting benzoic acid and its methyl ester. Further testing of this procedure is encouraged as removal of the byproducts without jeopardizing yields or efficiency appears very plausible.

The method sparked interest in the cyclopropanation and further reactions of enol acetates. In the brief time that this was explored, it was seen that dibromocarbene adds to the starting materials **5a** and **5b** to afford the corresponding cyclopropanes **30a** and **30b**. These proved

difficult to handle and often ring-opened or decomposed during the reaction conditions. In the future, the *gem*-dichloro equivalents should be prepared to allow for more controlled ring-openings. This is very interesting and applicable in the context of ring-opening of *gem*-dihalocyclopropanes as performed by Bakstad since it offers easy availability to cyclic acetylenic ketones such as **31a**, which can be very powerful reagents for synthetic purposes.

Acylolins **3a** and **3c** were also obtained through the original DMF/water method developed in Bakstad's laboratory in good yields, but any results were rather challenging to reproduce. Attempts at modifying the procedure to prepare the corresponding benzyl ethers gave complex mixtures as results, but spectroscopy hints at possible Favorskii- or α -ketol-type rearrangements of the type L. Paquette *et al.* have described, the latter being the most likely.

Preparation of acetyl protections were partly successful. Acetyl displacement of bromide in α -bromoketones was effective in yielding α -acetophenones **3e**, **3g**, and **3i**, but the conditions were not reactive enough for the conversion of their cyclic counterparts, **2a**, and **2c**. In some cases, harsh alkaline conditions such as heating in the presence of KOAc or basic methanolysis appeared to produce side products. Rearrangements of the α -ketol or Favorskii-type can be considered as the possible reason, but this should be explored further.

In addition, a simple and -to the best knowledge- novel procedure for the synthesis of 1,2-diketones was found in an alternative Rubottom oxidation. By utilizing bromoketone **2a** as starting material, a traditional preparation of TMS enol ethers gave **22a**. Epoxidation and subsequent ring-opening afforded diketone **26a**. Further investigations of this pathway should be done to document yields and side products as well as for optimization purposes.

4. Experimental

4.1 General

Nuclear magnetic resonance 400 MHz ^1H NMR spectra and 100 MHz ^{13}C NMR spectra were recorded on a Bruker AvIII HD 400 MHz spectrometer, and 500 MHz ^1H NMR spectra and 125 MHz ^{13}C NMR spectra were recorded on a Bruker Advance series 500 MHz AvII 500 spectrometer. Chemical shift of ^1H NMR spectra were reported in relative to tetramethylsilane (TMS) (δ 0.0 ppm). ^{13}C -NMR spectra are referenced in ppm to deuteriochloroform (δ 77.0 ppm).

Dry flash chromatography (DFC) was carried out with a silica gel (Fluka: silica gel 60, particle size 0.040-0.063 mm (230-400 mesh)). Vacuum was created by a water aspirator.

Flash chromatography (FC) was carried out using silica gel plates from Fluka (silica gel 60, particle size 0.040-0.063 mm) (230-400 mesh)).

Thin layer chromatography (TLC) was carried out using silica gel plates from Fluka (silica gel/dc-alufolien-kieselgel with fluorescent indicator, production number 60778). The spots were detected with UV (extinction at $\lambda=254$ or fluorescent at $\lambda=366$ nm) in a UVP-UV-cabinet and/or by staining with MOP (molybdate phosphoric acid (14 g) in ethanol (125 mL)) or CER-MOP (molybdate phosphoric acid (5 g), cerium(IV)sulfate (2 g) and 98% sulfuric acid (16 mL) in water (180 mL)) and developed by heating with a heat gun until spots appeared.

Thin layer chromatography (TLC) was generally used to monitor reactions. Workup was normally carried out when TLC indicated that all starting material had been consumed or that only traces remained.

Melting points (m.p.) were determined on a Stuart Scientific SMP3 melting point apparatus and were uncorrected. Infrared (IR) spectroscopy was performed on a Varian 1000 FT-IR spectrophotometer.

Nitrogen atmosphere was used in reactions that required dry conditions.

Commercial available chemicals were purchased from Fluka, Sigma-Aldrich, Acros, Merck, Lancaster and Chiron. Standard purification was applied if necessary. Dry dichloromethane, ethyl acetate and acetone were purchased from Fluka and Sigma-Aldrich. *m*-Chloroperbenzoic acid was regarded as 72% pure. Deviations from general procedures are specified in individual cases where due.

5.2 General procedure for the synthesis of α -bromoketones

p-Toluenesulfonic acid monohydrate (TsOH) (1.1 eq.) was dissolved in acetonitrile (MeCN) (200 mL) and added dropwise to a stirred solution of the starting ketone (1 eq.) and *N*-bromosuccinimide (NBS) (1.1 eq.) in dimethoxyethane (DME) (200 mL). The reaction was stirred at room temperature (r.t.) until completion. Water (200 mL) was added and the mixture was extracted with heptanes (3 x 75 mL). The combined organic phases were washed with water (6 x 15 mL) and dried (Na₂SO₄). The solvents were removed under reduced pressure.

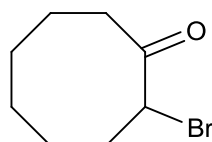

2-Bromocyclooctanone (**2a**)

The compound was obtained from **1a** (55.5 g, 440.0 mmol), TsOH (91.3 g, 484.0 mmol) and NBS (86.2 g, 484.0 mmol), after solvents were removed under reduced pressure as a pale yellow oil. Yield: 86.6 g (96%).

$R_f=0.80$ (10% EtOAc in methylcyclohexane). IR (neat): 2970, 1701, 1448, 1087, 1045, 880, 700 cm⁻¹; ¹H NMR (400 MHz, CDCl₃): δ 4.24 (dd, $J= 11.12, 4.4$ Hz, 1 H), 2.83 (dt, $J= 12.2, 12.0$ Hz, 2 H), 2.40-2.35 (m, 2 H), 2.34-2.24 (m, 2H), 1.78-1.50 (m, 6 H); ¹³C NMR (100 MHz, CDCl₃): δ 208.5, 54.3, 46.1, 32.6, 28.6, 26.4, 25.3 ppm. Spectroscopic properties were in accordance with previous results^{[31][47]}.

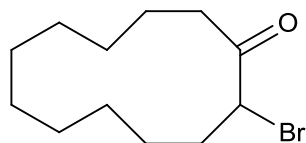

2-Bromocyclododecanone (**2c**)

The compound was obtained from **1c** (54.7 g, 300.0 mmol), TsOH (69.0 g, 330.0 mmol) and NBS (58.7 g, 330.0 mmol), after solvents were removed under reduced pressure as a, colorless oil. Yield:76.7

g (98%).

$R_f=0.86$ (10% EtOAc in methylcyclohexane). IR (neat): 2938, 1710 cm⁻¹; ¹H NMR (400 MHz, CDCl₃): δ 4.39 (dd, $J= 11.7, 3.7$ Hz, 1 H), 2.84-2.67 (m, 2 H), 2.35-2.26 (m, 2H), 2.02-1.87 (m, 2 H), 1.63-1.55 (m, 2 H), 1.41-1.19 (m, 12 H) ppm; ¹³C NMR (100 MHz, CDCl₃): δ 205.5, 51.6, 35.2, 33.5, 25.3, 25.1, 24.1, 23.7, 22.4, 22.2 ppm. Spectroscopic properties were in accordance with previous results^[31].

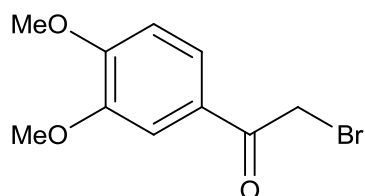

2-Bromo-3',4'-dimethoxyacetophenone (**2g**)

The compound was obtained from **1g** (18.0 g, 100.0 mmol), TsOH (20.9 g, 110.0 mmol) and NBS (19.6 g, 110.0 mmol) after solvents were removed under reduced pressure as a white-pink solid. Yield:24.3 g (94%).

$R_f=0.50$ (40% EtOAc in heptane). IR (neat): 2935, 1779, 1584, 1513, 1418, 1240, 1149 cm⁻¹; ¹H NMR (400 MHz, CDCl₃): δ 7.61-7.52 (m, 2H), 6.9 (d, $J= 8.6$ Hz, 1 H), 4.4 (s, 2 H), 3.95 (s, 3 H), 3.93 (s, 3H) ppm; ¹³C NMR (100 MHz, CDCl₃): δ 190.0, 154.0 149.2, 127.0, 123.9, 110.8, 110.5, 56.1, 56.0, 30.3 ppm. Spectroscopic properties were in accordance with the literature^[50].

5.3 General procedure for previous synthesis of acyloins

The starting α -bromoketone (1 eq.) was dissolved in a mixture of *N,N*-dimethylformamide (DMF) (100 mL) and water (100 mL). The solution was heated to 140°C and stirred until completion, which generally took overnight or longer. The mixture was saturated with salt and extracted with EtOAc (5 x 75 mL). The combined organic phases were washed with brine (6 x 20 mL). The solvents were removed under reduced pressure.

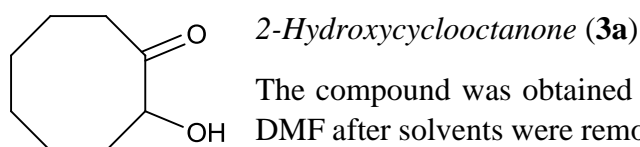

The compound was obtained from **2a** (20.5 g, 100.0 mmol) and water in DMF after solvents were removed under reduced pressure as an orange oil. Yield: 10.6 g (75%).

$R_f=0.22$ (20% EtOAc in methylcyclohexane). IR (neat): 3456, 1708 cm^{-1} ; ^1H NMR (400 MHz, CDCl_3): δ 4.18 (dd, $J=6.3, 2.7$ Hz, 1 H), 3.73 (s, 1 H), 2.71 (dt, $J=12.02, 3.9$ Hz, 2 H), 2.42-2.30 (m, 2 H), 2.07-1.92 (m, 2 H), 1.84-1.61 (m, 8 H) ppm; ^{13}C NMR (100 MHz, CDCl_3): δ 217.5, 76.2, 37.3, 29.3, 28.6, 25.5, 24.5, 22.1 ppm. Spectroscopic properties were in accordance with previous results^[31].

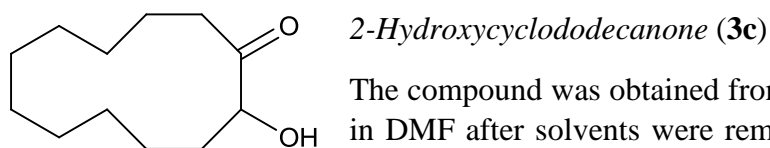

The compound was obtained from **2c** (6.5 g, 25.0 mmol) and water in DMF after solvents were removed under reduced pressure as a pale yellow solid. Yield: 4.8 g (97%).

$R_f=0.20$ (10% EtOAc in methylcyclohexane). IR (neat): 3471, 1705 cm^{-1} ; ^1H NMR (400 MHz, CDCl_3): δ 4.40-4.39 (m, 1 H), 3.59 (s, 1 H), 3.07-2.99 (m, 2 H), 2.24-2.11 (m, 2 H), 1.99-1.92 (m, 2 H), 1.55-1.14 (m, 14 H) ppm; ^{13}C NMR (100 MHz, CDCl_3): δ 212.9, 76.5, 34.3, 30.7, 26.1, 23.9, 26.1, 22.6, 22.0, 21.4, 18.7 ppm. Spectroscopic properties were in accordance with the previous results^[47].

5.4 General procedure for the synthesis of α -acetoxyketones

The starting α -bromoketone (1 eq.) was dissolved in acetonitrile (MeCN) or *N,N*-dimethylformamide (DMF) (150 mL), and potassium acetate (KOAc) (1.5 eq) was added to the mixture. The reaction was stirred at r.t. until completion. Water (100 mL) was added and the mixture was extracted with diethyl ether (Et_2O) (50 mL x 4). The combined organic phases were washed with water (6 x 20 mL) and dried (Na_2SO_4). The solvents were removed under reduced pressure.

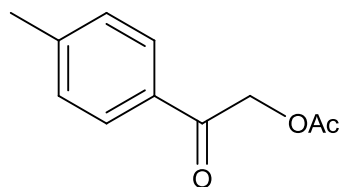

2-Acetoxy-4'-methylacetophenone (4e)

The compound was obtained from **2e**^[32] (15.0 g, 70.0 mmol) and KOAc (10.31 g, 105.0 mmol) in MeCN after solvents were removed under reduced pressure as a colorless solid. Yield: 10.5 g (78%).

$R_f=0.40$ (40% EtOAc in methylcyclohexane). M.p.(not recrystallized)=81-82 °C (82 °C^[52]). IR (neat): 2955, 1735, 1694, 1603, 1369, 1224, 1180, 965, 809 cm^{-1} ; ^1H NMR (400 MHz, CDCl_3): δ 7.76 (d, $J=8.1$ Hz, 2 H), 7.25 (d, $J=8.1$ Hz, 2 H), 5.31 (s, 2 H), 2.44 (s, 3 H), 2.21 (s, 3 H) ppm; ^{13}C NMR (100 MHz, CDCl_3): δ 191.7, 170.4, 144.9, 131.6, 129.4, 127.8, 65.9, 21.7, 20.5 ppm. Spectroscopic properties were in accordance with the literature^[52].

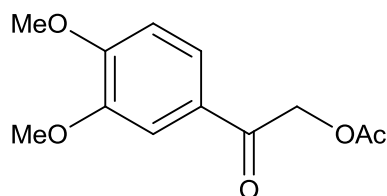

2-Acetoxy-3',4'-methoxyacetophenone (4g)

The compound was obtained from **2g** (6.0 g, 25.0 mmol) and KOAc (3.7 g, 37.5 mmol) in DMF after solvents were removed under reduced pressure as yellow crystals. Yield: 3.9 g (88%).

$R_f=0.44$ (40% EtOAc in heptane). M.p.(not recrystallized)=72-74 °C (74-75 °C^[51]). IR (neat): 2937, 1750, 1687, 1515, 1420, 1261, 1230, 1149, 1012, 766 cm^{-1} ; ^1H NMR (400 MHz, CDCl_3): δ 7.59-7.49 (m, 2 H), 6.90 (d, $J=3.2$ Hz, 1 H), 5.31 (s, 2 H), 3.95 (s, 3 H), 3.93 (s, 3 H), 2.23 (s, 3 H) ppm; ^{13}C NMR (100 MHz, CDCl_3): δ 190.7, 170.5, 153.9, 149.3, 127.4, 124.8, 122.2, 109.9, 65.7, 56.1, 20.6 ppm. Spectroscopic properties were in accordance with the literature^[51].

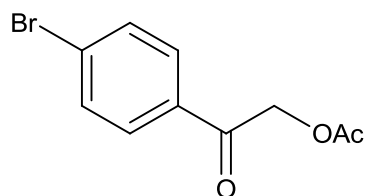

2-Acetoxy-4'-bromoacetophenone (4i)

The compound was obtained from **2i** (5 g, 18.0 mmol) and KOAc (2.65 g, 27.0 mmol) in DMF after solvents were removed under reduced pressure as yellow crystals. Yield: 3.9 g (75%).

$R_f=0.45$ (40% EtOAc in methylcyclohexane). M.p.(not recrystallized)=81-83 °C (83 °C^[52]). IR (neat): 2948, 1742, 1692, 1584, 1372, 1219, 1068, 997, 812, 712 cm^{-1} ; ^1H NMR (400 MHz, CDCl_3): δ 7.76 (d, $J=8.1$ Hz, 2 H), 7.60 (d, $J=8.1$ Hz, 2 H), 5.30 (s, 2 H), 2.23 (s, 3 H) ppm; ^{13}C NMR (100 MHz, CDCl_3): δ 191.2, 183.6, 169.8, 132.2, 128.9, 65.8, 20.5 ppm. Spectroscopic properties were in accordance with the literature^[52].

5.5 General procedure for methanolysis of acetates

The starting acetates (1 eq.) were dissolved in methanol (MeOH) (200 mL) and added catalytical amounts of TsOH. The mixture was stirred at r.t. until completion and the solvents were removed under reduced pressure.

The procedure was performed on epoxides **6a** and **6b**, and α -acetoxyacetophenones **4e**, **4g**, and **4i**. For the latter, diagnostic NMR peaks confirmed the formation of acyloins **3e**, **3g**, and **3i**.

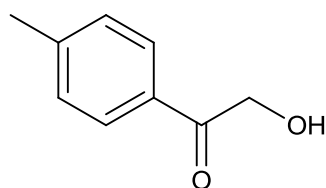

2-Hydroxy-4'-methylacetophenone (3e)

The compound was obtained from methanolysis of **4e** (3.8 g, 16.0 mmol) according to the general procedure (5.5). Yield: 2.6 g (83%). $R_f=0.12$ (40% EtOAc in methylcyclohexane). Spectroscopic properties were in accordance with previous results^[32].

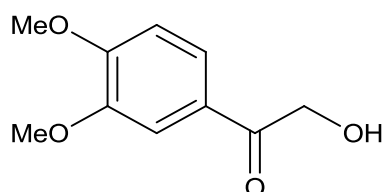

2-Hydroxy-3',4'-dimethoxyacetophenone (3g)

The compound was obtained from methanolysis of **4g** (3.8 g, 16.0 mmol) according to the general procedure (5.5). Yield: 2.6 g (83%). $R_f=0.19$ (40% EtOAc in heptane). Spectroscopic properties were in accordance with the literature^[53].

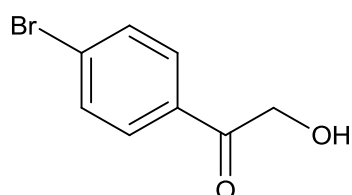

4'-Bromo-2-hydroxyacetophenone (3i)

The compound was obtained from methanolysis of **4i** (3.8 g, 16.0 mmol) according to the general procedure (5.5). Yield: 2.6 g (83%). $R_f=0.20$ (40% EtOAc in methylcyclohexane). Spectroscopic properties were in accordance with previous results^[32].

5.6 General procedure for the synthesis of vinyl esters

To a mixture of the starting ketone (1 eq.) and isopropenyl acetate (250 mL) in a continuous-distillation set-up was added catalytical amounts of TsOH. The mixture was stirred in heat until completion, which was generally after ~4 hours or less. After allowing to cool to r.t., water (200 mL) was added and the mixture was extracted with heptane (4 x 75 mL). The combined organic phases were washed with water (6 x 20 mL) and dried (Na_2SO_4). The solvents were removed under reduced pressure.

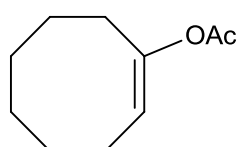

1-Acetoxycyclooctene (5a)

The compound was obtained from **1a** (63.1 g, 500.0 mmol), isopropenyl acetate (350 mL), and TsOH after solvents were removed under reduced pressure as a pale yellow oil. Yield: 84.1 g (100%).

$R_f=0.51$ (20% EtOAc in heptane). IR (neat): 2926, 2853, 1750, 1684, 1366, 1205, 1131, 1064 cm^{-1} ; ^1H NMR (400 MHz, CDCl_3): δ 5.25 (t, $J=8.6$ Hz, 1 H), 2.30-2.27 (m, 2 H), 2.08 (s, 3 H), 2.10-2.08 (m, 2 H), 1.64-1.49 (m, 8 H) ppm; ^{13}C NMR (100 MHz, CDCl_3): δ 169.7, 150.2, 116.2, 29.5, 27.7, 26.1, 25.6, 24.7, 20.9 ppm. Spectroscopic properties were in accordance with the literature^{[54][55]}.

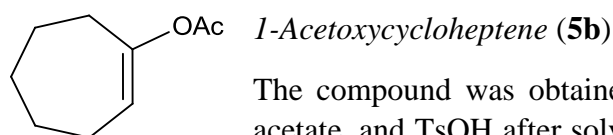

The compound was obtained from **1b** (28 g, 250.0 mmol), isopropenyl acetate, and TsOH after solvents were removed under reduced pressure as a colorless oil. Yield: 38.0 g (99%).

$R_f=0.47$ (20% EtOAc in heptane). IR (neat): 2924, 2853, 1746, 1687, 1366, 1231, 1205, 1090 cm^{-1} ; $^1\text{H NMR}$ (400 MHz, CDCl_3): δ 5.44 (t, $J=6.5$ Hz, 1 H), 2.30-2.27 (m, 2 H), 2.11-2.06 (m, 2 H), 2.07 (s, 3 H), 1.73-1.55 (m, 6 H) ppm; $^{13}\text{C NMR}$ (100 MHz, CDCl_3): δ 169.7, 153.1, 117.9, 33.0, 30.4, 26.9, 25.1, 20.9 ppm. Spectroscopic properties were in accordance with the literature^{[55][56]}.

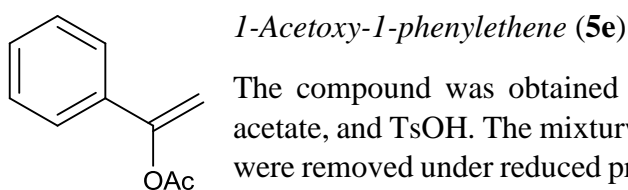

The compound was obtained from **1e** (12.0 g, 100.0 mmol), isopropenyl acetate, and TsOH. The mixture was extracted with Et_2O (4 x 75 mL). Solvents were removed under reduced pressure to give the product as a dark brown oil. Yield: 15.7 g (97%).

$R_f=0.41$ (40% EtOAc in heptane). IR (neat): 2929, 1761, 1684, 1265, 1202, 1019, 773, 691 cm^{-1} ; $^1\text{H NMR}$ (400 MHz, CDCl_3): δ 7.50-7.47 (m, 2 H), 7.39-7.34 (m, 3 H), 7.50 (d, $J=2.2$ Hz, 1 H), 5.04 (d, $J=2.2$ Hz, 1 H), 2.29 (s, 3 H) ppm; $^{13}\text{C NMR}$ (100 MHz, CDCl_3): δ 152.9, 134.2, 128.9, 128.5, 124.8, 102.1, 20.9 ppm. Spectroscopic properties were in accordance with the literature^[57].

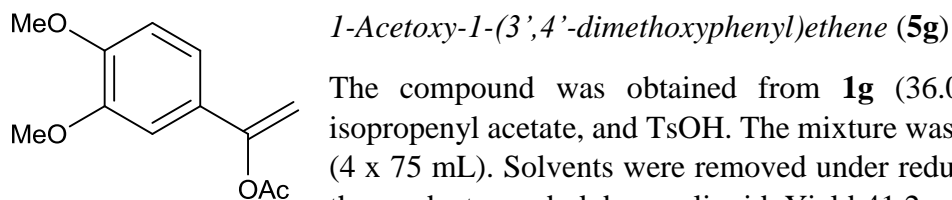

The compound was obtained from **1g** (36.0 g, 200.0 mmol), isopropenyl acetate, and TsOH. The mixture was extracted with Et_2O (4 x 75 mL). Solvents were removed under reduced pressure to give the product as a dark brown liquid. Yield: 41.2 g (93%).

$R_f=0.42$ (20% EtOAc in heptane). IR (neat): 2937, 2838, 1759, 1515, 1202, 1023 cm^{-1} ; $^1\text{H NMR}$ (400 MHz, CDCl_3): δ 7.02-6.98 (m, 2 H), 6.81 (d, $J=8.3$ Hz, 1 H), 5.34 (d, $J=2.2$ Hz, 1 H), 4.92 (d, $J=2.2$ Hz, 1 H), 3.88 (s, 3 H), 3.86 (s, 3 H), 2.23 (s, 3 H) ppm; $^{13}\text{C NMR}$ (100 MHz, CDCl_3): δ 168.9, 152.6, 149.7, 117.6, 110.8, 108.1, 100.4, 55.9, 55.7, 20.8 ppm. Compound not described in the literature.

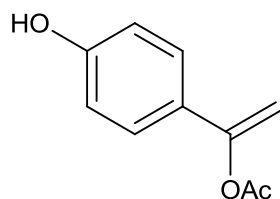
*1*-Acetoxy-1-(4'-hydroxyphenyl)ethene (**5h**)

The compound was obtained from **1h** (27.4 g, 200.0 mmol), isopropenyl acetate, and TsOH. The mixture was extracted with Et₂O (4 x 75 mL). Solvents were removed under reduced pressure to give a dark liquid. Yield was not available due to the presence of other compounds, which made separations challenging.

R_f=0.40 (20% EtOAc in heptane). IR (neat): 1755, 1685, 1505, 1367, 1163, 1187, 1012, 848 cm⁻¹; ¹H NMR (400 MHz, CDCl₃): δ 7.50 (d, *J*= 8.9 Hz, 2 H), 7.18 (d, *J*= 8.9 Hz, 2 H), 5.44 (d, *J*= 2.4 Hz, 1 H), 5.03 (d, *J*= 2.4 Hz, 1 H), 2.58 (s, 1 H), 2.28 (s, 3 H) ppm; ¹³C NMR (100 MHz, CDCl₃): δ 169.0, 152.0, 131.9, 129.8, 126.0, 121.6, 102.2, 20.8 ppm. Compound not described in the literature.

5.7 General procedure for the synthesis of vinyl-trimethylsilyl ethers (TMS-vinyl ethers)

The starting ketone (1 eq.) and trimethylsilyl chloride (TMSCl) (1.2 eq.) was dissolved in dry tetrahydrofuran (THF) (75 mL) under nitrogen (N_{2(g)}) atmosphere. The mixture was cooled to 0° C. Sodium bis(trimethylsilyl)amide (NaHMDS) (1.2 eq., 1M in THF) was added to the solution dropwise. The reaction stirred at 0° C for 2-4 hours. 20% K₂CO_{3(aq.)} (75 mL) was added and the mixture was extracted with Et₂O (4 x 25 mL). The combined organic phases were washed with 20% K₂CO_{3(aq.)} and dried (K₂CO_{3(s)}). The solvents were removed under reduced pressure.

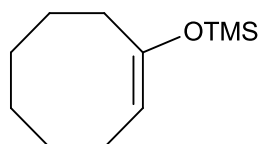
*1*-Trimethylsilyloxycyclooctene (**20a**)

The compound was obtained from **1a** (5.1 g, 40.0 mmol), TMSCl (5.2 g, 48.0 mmol) and NaHMDS (48 mL, 48.0 mmol) in dry Et₂O (100 mL) after solvents were removed under reduced pressure as a yellow oil.

Yield: 7.2 g (92%).

IR (neat): 2924, 2851, 1661, 1448, 1250, 1165, 1087, 960, 837, 751 cm⁻¹; ¹H NMR (400 MHz, CDCl₃): δ 4.75 (t, *J*= 8.32 Hz, 1 H), 2.20-2.17 (m, 2 H), 2.04-1.99 (m, 2 H), 1.6-1.48 (m, 8 H), 0.20 (s, 9 H) ppm; ¹³C NMR (100 MHz, CDCl₃): δ 153.0, 105.4, 30.9, 27.5, 26.4, 25.5, 0.4 ppm. Spectroscopic properties were in accordance with the literature^[58].

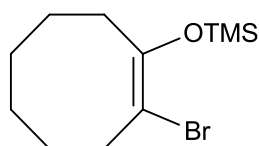
*1*-Bromo-2-trimethylsilyloxycyclooctene (**21a**)

The compound was obtained from **2a** (2.1 g, 10.0 mmol), TMSCl (1.3 g, 12.0 mmol), and NaHMDS (12 mL, 12.0 mmol) after solvents were removed under reduced pressure as a clear red-orange oil. Yield was not available due to the presence of other compounds which made separations challenging.

IR (neat): 2926, 2853, 1459, 1250, 1231, 1121, 1086, 969, 841, 757 cm⁻¹; ¹H NMR (400 MHz, CDCl₃): δ 3.77-3.35 (m, 2 H), 2.57-2.54 (m, 2 H), 2.30-2.29 (m, 2 H), 1.67-1.53 (m, 8 H), 0.25 (s, 9 H) ppm; ¹³C NMR (100 MHz, CDCl₃): δ 148.7, 104.0, 35.1, 32.7, 25.6, 26.5, 25.7, 25.5, 1.9 ppm. Compound not described in the literature.

5.8 General procedure for epoxidation of olefins

The starting olefin (1 eq.) was dissolved in DCM (200 mL). *m*-Chloroperbenzoic acid (MCPBA) (1 eq.) was added to the solution. The mixture stirred at r.t. until completion, which generally took no more than 5 hours. The mixture was cooled to 0° C and filtered under reduced pressure. The filtrate was washed with cool DCM. The solvent was removed under reduced pressure, and the crude dissolved in Et₂O (150 mL). The solution was washed with 10% NaHCO_{3(aq.)} (6 x 15 mL). The solvent was removed once again under pressure to give the crude product.

5.8.1 Epoxidation of vinyl esters

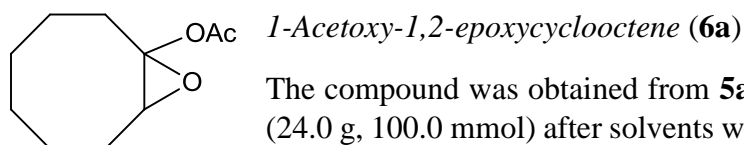

The compound was obtained from **5a** (16.8 g, 100.0 mmol) and MCPBA (24.0 g, 100.0 mmol) after solvents were removed under reduced pressure. Yield was not available as crude product was used for further reactions.

R_f=0.37 (20% EtOAc in heptane). IR (neat): N/A; ¹H NMR (400 MHz, CDCl₃): N/A; ¹³C NMR (100 MHz, CDCl₃): δ 169.6, 85.1, 60.1, 27.6, 24.9, 24.6, 21.3, 25.9 ppm. Spectroscopic properties were in accordance with the literature^[59].

5.8.2 Synthesis of 1,2-cyclooctadione

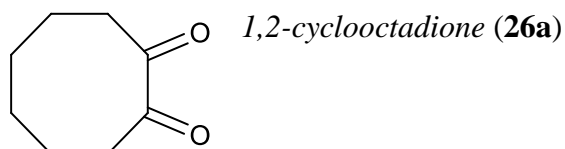

Procedure (1): Starting material **21a** (4.16 g, 15.0 mmol) was epoxidized in DCM (75 mL) according to the general procedure described above. MCPBA (4.0 g, 15.0 mmol) was added slowly. After stirring at r.t. for 2 hours, the mixture was cooled to 0° C and the precipitate filtered under reduced pressure. The solvents were removed under reduced pressure and the crude redissolved in DME (75 mL). The new mixture was added TsOH (catalytical amounts) and stirred in mild heat (40-50° C) for 30 minutes. 20% K₂CO_{3(aq.)} (75 mL) was added and the mixture was extracted with Et₂O (4 x 20 mL). The combined organic phases were washed with water (5 x 20 mL). A mixture of compounds that contained 1,2-Cyclooctadione (**26a**) was obtained.

Procedure (2): Starting material **21a** (4.16 g, 15.0 mmol) was epoxidized in heptane (75 mL) according to the general procedure described above. MCPBA (4.0 g, 15.0 mmol) was added slowly. After stirring at r.t. for 2 hours, the mixture was cooled to 0° C and the precipitate filtered under reduced pressure. TsOH (catalytical amounts) was added to the supernatant followed by stirring in mild heat (40-50° C) for 30 minutes. 20% K₂CO_{3(aq.)} (75 mL) was added, and the organic phase was separated and washed with water (5 x 20 mL). A mixture of compounds that contained 1,2-Cyclooctadione (**26a**) was obtained.

Yield was not available due to the presence of other compounds which made separations challenging. The compound was identified from spectroscopic signals that matched the literature^[41]. $R_f=0.62$ (10% EtOAc in heptane). IR (neat): N/A; $^1\text{H NMR}$ (400 MHz, CDCl_3): N/A; $^{13}\text{C NMR}$ (100 MHz, CDCl_3): δ 199.3, 30.1, 26.4, 21.2 ppm.

5.11 General procedure for the synthesis of dihydrodioxins

The starting vinyl esters (**5a**, **5b**) (1 eq.) were epoxidized and subsequently ring-opened by methanolysis in the procedures already described (5.8 and 5.5, respectively). The resulting crude acyloins (**3a**, **3b**) were redissolved in toluene (150 mL) and transferred to a Dean-Stark apparatus. Ethylene glycol (15 mL), and TsOH (catalytical amounts) were added, and the reaction was stirred in reflux overnight. 10% $\text{NaHCO}_3(\text{aq.})$ (150 mL) was added and the mixture was extracted with heptane. The combined organic phases were washed with water and dried (Na_2SO_4). The solvents were removed under reduced pressure and the crude product was purified by dry flash chromatography (DFC) (1% EtOAc in heptane).

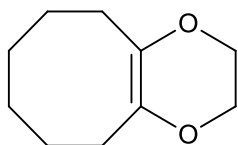

9,12-Dioxabicyclo[6.4.0]dodecene (7a)

The compound was obtained from epoxidation and subsequent ring-opening of **5a** (16.7, 99.3 mmol) to **3a**, and the latter's reaction with ethylene glycol and TsOH in toluene (see general procedure above). DFC afforded **7a** as a colorless liquid. Yield: 11.3 g (66% total).

$R_f=0.56$ (20% EtOAc in heptane). IR (neat): 2920, 2851, 1455, 1202, 1123, 1050, 926, 878 cm^{-1} ; $^1\text{H NMR}$ (400 MHz, CDCl_3): δ 3.9 (s, 4 H), 2.15-2.12 (m, 4 H), 1.60-1.50 (m, 8 H) ppm; $^{13}\text{C NMR}$ (100 MHz, CDCl_3): δ 131.2, 64.5, 29.0, 28.9, 26.5 ppm. Spectroscopic properties were in accordance with the literature^[30].

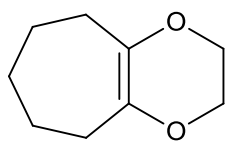

8,11-Dioxabicyclo[5.4.0]undecene (7b)

The compound was obtained from epoxidation and subsequent ring-opening of **5b** (7.7 g, 50.0 mmol) to **3b**, and the latter's reaction with ethylene glycol and TsOH in toluene (see general procedure above). DFC afforded **7b** as a colorless liquid. Yield: 1.5 g (20 %).

$R_f=0.55$ (20% EtOAc in heptane). IR (neat): 2926, 2860, 1455, 1215, 1094, 945, 882 cm^{-1} ; $^1\text{H NMR}$ (400 MHz, CDCl_3): δ 3.9 (s, 4 H), 1.79-1.76 (m, 4 H), 1.58-1.53 (m, 6 H) ppm; $^{13}\text{C NMR}$ (100 MHz, CDCl_3): δ 113.0, 63.9, 38.4, 29.3, 22.5 ppm. Spectroscopic properties were in accordance with the literature^[30].

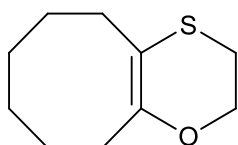

9,12-Oxathiabicyclo[6.4.0]dodecene (19a)

The compound was obtained from **3a** (3.6 g, 25.0 mmol), 2-mercaptoethanol (5 mL), and TsOH in toluene (see general procedure above), as a dark brown oil. Yields not available due to the presence of other compounds which made separations challenging.

$R_f=0.63$ (20% EtOAc in heptane). IR (neat): 2927, 2854, 1701, 1443, 1319, 1169, 938 cm^{-1} ; ^1H NMR (400 MHz, CDCl_3): δ 4.21-4.18 (m, 2 H), 2.98-2.97 (m, 2 H), 2.27-2.24 (m, 2 H), 2.17-2.15 (m, 2 H), 1.61-1.56 (m, 8 H) ppm; ^{13}C NMR (100 MHz, CDCl_3): δ 146.3, 99.3, 65.2, 31.5, 31.1, 29.3, 29.0, 26.5, 26.1 ppm. Spectroscopic properties were in accordance with the literature^[30].

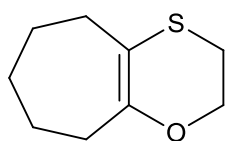

8,11-Oxathiabicyclo[5.4.0]undecene (19b)

The compound was obtained from **3b** (3.2 g, 25.0 mmol) 2-mercaptoethanol (5 mL), and TsOH in toluene (see general procedure above), as a dark brown oil. Yields not available due to the presence of other compounds which made separations challenging.

$R_f=0.59$ (20% EtOAc in heptane). IR (neat): 2922, 2853, 1692, 1649, 1453, 1321, 1165, 1045, 937 cm^{-1} ; ^1H NMR (400 MHz, CDCl_3): δ 4.18-4.16 (m, 2 H), 2.96-2.95 (m, 2 H), 2.29-2.27 (m, 2 H), 2.09-2.06 (m, 2 H), 1.59-1.41 (m, 6 H) ppm; ^{13}C NMR (100 MHz, CDCl_3): δ 149.5, 100.8, 65.0, 31.6, 26.8, 26.4, 25.1, 24.1 ppm. Compound not described in the literature.

5.12 General procedure for addition of dibromocarbene to olefins

Doering-Hoffmann: The starting olefin (1 eq.) was dissolved in dry pentane (100 mL) under $\text{N}_{2(\text{g})}$ atmosphere and cooled to -70°C before potassium *tert*-butoxide (*t*-BuOK) (≥ 5 eq.) was added to the stirring mixture. Bromoform (≥ 2.5 eq) was added dropwise to the mixture. The mixture was stirred below -40°C until completion, which generally took no more than 4 hours. The mixture was filtered in celite with cold pentane and the solvents were removed under reduced pressure.

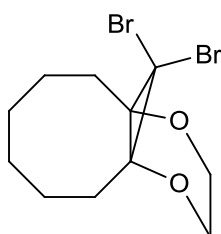

13,13-Dibromo-9,12-dioxabicyclo[6.4.1]propellane (8a)

The compound was obtained from **7a** (1.7 g, 10.0 mmol), bromoform (6.3 g, 25.0 mmol) and *t*-BuOK (5.6 g, 50.0 mmol) in the general procedure for the **Doering-Hoffmann** reaction. Yield: 3.0 g (88%).

$R_f=0.61$ (20% EtOAc in heptane). IR (neat): 2924, 2853, 1718, 1258, 1164, 1097, 905, 766, 728 cm^{-1} ; ^1H NMR (400 MHz, CDCl_3): δ 4.20-4.13 (m, 2 H), 3.93-3.87 (m, 2 H), 2.20-2.19 (m, 2 H), 2.17-2.16 (m, 2 H), 1.81-1.45 (m, 8 H) ppm; ^{13}C NMR (100 MHz, CDCl_3): δ 62.8, 62.7, 46.9, 32.7, 26.1, 24.4 ppm. Spectroscopic properties were in accordance with the literature^[60].

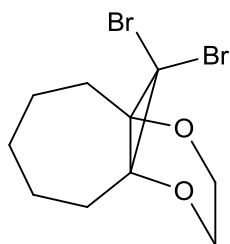

12,12-Dibromo-8,11-dioxapropellane (8b)

The compound was obtained from **7b** (0.1 g, 0.65 mmol), bromoform (6.3 g, 25.0 mmol) and *t*-BuOK (5.6 g, 50.0 mmol) in the general procedure for the **Doering-Hoffmann** reaction. Yield: 0.15 g (71%).

$R_f=0.58$ (20% EtOAc in heptane). IR (neat): 2972, 2927, 2857, 1720, 1455, 1366, 1254, 1144, 1019, 650 cm^{-1} ; $^1\text{H NMR}$ (400 MHz, CDCl_3): δ 4.16-4.11 (m, 2 H), 3.85-3.80 (m, 2 H), 2.36-2.32 (m, 2 H), 2.32-2.30 (m, 2 H), 1.90-1.44 (m, 6 H) ppm; $^{13}\text{C NMR}$ (100 MHz, CDCl_3): δ 64.1, 49.4, 36.3 ppm. Compound not described in the literature.

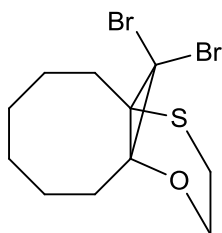

13,13-Dibromo-9,12-oxathia[6.4.1]propellane (20a)

The compound was obtained from (0.9 g, 5.0 mmol), bromoform (6.3 g, 25.0 mmol) and *t*-BuOK (5.6 g, 50.0 mmol) in the general procedure for the **Doering-Hoffmann** reaction. Yields not available due to the presence of other compounds.

$R_f=0.64$ (20% EtOAc in heptane). IR (neat): 2972, 2927, 2855, 1720, 1459, 1151, 1086, 805 cm^{-1} ; $^1\text{H NMR}$ (400 MHz, CDCl_3): N/A; $^{13}\text{C NMR}$ (100 MHz, CDCl_3): δ 62.8, 62.5 ppm. Compound not described in the literature.

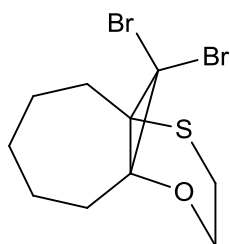

12,12-Dibromo-8,11-dioxapropellane (20b)

The compound was obtained from **19b** (0.5 g, 3.0 mmol), bromoform (6.3 g, 25.0 mmol) and *t*-BuOK (5.6 g, 50.0 mmol) in the general procedure for the **Doering-Hoffmann** reaction. Yields not available due to the presence of other compounds.

$R_f=0.52$ (20% EtOAc in heptane). IR (neat): 2972, 2887, 1381, 1087, 1045, 879 cm^{-1} ; $^1\text{H NMR}$ (400 MHz, CDCl_3): N/A; $^{13}\text{C NMR}$ (100 MHz, CDCl_3): 62.9, 62.5 ppm. Compound not described in the literature.

5.13 Reactions of strained *gem*-dibromocyclopropanes

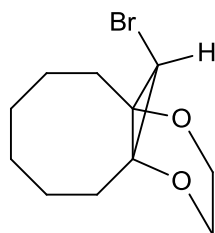

13-Bromo-9,12-dioxo[6.4.1]propellane (9a)

The starting dibromide **8a** (0.34 g, 1.0 mmol) was dissolved in dry Et₂O (20 mL) under N_{2(g)} atmosphere and cooled to -70° C. A 1.5 M ethereal solution of methyllithium (MeLi) (0.8 mL, 1.2 mmol) was added to the mixture. The reaction was stirred for 30 min. Water (20 mL) was added, and the mixture was allowed to rise to r.t., after which it was extracted with Et₂O (4 x 20 mL). The combined organic phases were washed with water (5 x 10 mL) and dried (Na₂SO₄). The solvents were removed under reduced pressure to give the monobromide as a yellow oil. Yield: 0.23 g (88%).

R_f=0.48 (20% EtOAc in heptane). IR (neat): ; ¹H NMR (400 MHz, CDCl₃): δ 3.82-3.77 (m, 2 H), 3.71-3.66 (m, 2 H), 3.64 (s, 1 H), 2.04-2.02 (m, 2 H), 2.00-1.97 (m, 2 H), 1.79-1.43 (m, 8 H) ppm; ¹³C NMR (100 MHz, CDCl₃): δ 62.5, 62.4, 31.9, 31.0, 26.3, 24.3 ppm. Compound not described in the literature.

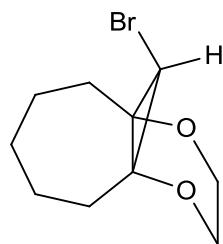

12-Bromo-8,11-dioxo[5.4.1]propellane (9b)

The starting dibromide **8b** (0.1 g, 0.3 mmol) was dissolved in dry Et₂O (20 mL) under N_{2(g)} atmosphere and cooled to -70° C. MeLi (0.23 mL, 0.36 mmol) was added to the mixture. The reaction was stirred for 30 min. Water (20 mL) was added, and the mixture was allowed to rise to r.t., after which it was extracted with Et₂O (4 x 20 mL). The combined organic phases were washed with water (5 x 10 mL) and dried (Na₂SO₄). The solvents were removed under reduced pressure to give the monobromide as a red-orange oil. Yields not available due to the presence of other compounds. Separation was not attempted due to time constraints.

R_f=, (20% EtOAc in heptane). IR (neat): 2922, 2857, 1459, 1272, 1162, 1121, 907, 736 cm⁻¹; ¹H NMR (400 MHz, CDCl₃): δ 3.83-3.80 (m, 2 H), 3.66-3.64 (m, 2 H), 3.63 (s, 1 H) ppm; ¹³C NMR (100 MHz, CDCl₃): δ 65.1, 62.5, 31.4 ppm. Compound not described in the literature.

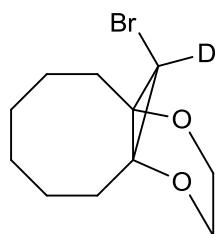

Isotope labeling experiment (10a)

The starting dibromide **8a** (0.34 g, 1.0 mmol) was dissolved in dry Et₂O (20 mL) under N_{2(g)} atmosphere and cooled to -70° C. MeLi (0.23 mL, 0.36 mmol) was added to the mixture. The reaction was stirred for 30 min. Deuterium oxide (D₂O) (2 mL) was added, and the mixture was allowed to rise to r.t., after which it was extracted with Et₂O (4 x 20 mL). The combined organic phases were washed with water (5 x 10 mL) and dried (Na₂SO₄). The solvents were removed under reduced pressure to give a red-orange oil. Yield: 0.22 g (88%).

$R_f=0.48$ (20% EtOAc in heptane). IR (neat): 2920, 2857, 1715, 1459, 1125, 1068, 924, 900, 711 cm^{-1} ; $^1\text{H NMR}$ (400 MHz, CDCl_3): δ 3.81-3.76 (m, 2 H), 3.71-3.65 (m, 2 H), 2.03-2.01 (m, 2 H), 1.99-1.97 (m, 2 H), 1.79-1.42 (m, 8 H) ppm; $^{13}\text{C NMR}$ (100 MHz, CDCl_3): δ 62.5, 62.3, 31.9, 30.9, 26.3, 24.3 ppm. Compound not described in the literature.

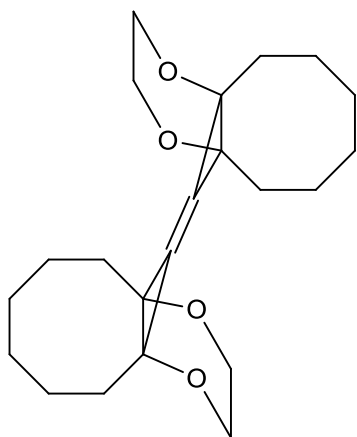

Dimerization of 8a (14a)

The starting dibromide **8a** (0.34 g, 1.0 mmol) was dissolved in dry THF (20 mL) under $\text{N}_2(\text{g})$ atmosphere and cooled to -70°C . MeLi (0.8 mL, 1.2 mmol) was added to the mixture. The reaction was stirred for 30 min and then allowed to rise to r.t., after which it stirred overnight. The mixture was extracted with Et_2O (4 x 20 mL). The combined organic phases were washed with water (5 x 10 mL) and dried (Na_2SO_4). The solvents were removed under reduced pressure to give **14a** as a red-orange oil. Yield: 0.18 g (100%).

$R_f=0.50$ (20% EtOAc in heptane). IR (neat): 2920, 2857, 1455, 1259, 1189, 1086, 911, 732, 676 cm^{-1} ; $^1\text{H NMR}$ (400 MHz, CDCl_3): δ 3.94-3.89 (m, 2 H), 3.85-3.79 (m, 2 H), 2.13-2.12 (m, 2 H), 2.10-2.08 (m, 2 H), 1.83-1.51 (m, 8 H) ppm; $^{13}\text{C NMR}$ (100 MHz, CDCl_3): δ 62.6, 61.8, 45.7, 33.2, 26.3, 24.8, 20.8 ppm. Compound not described in the literature.

5. Abbreviations

Ac	Acetyl	N/A	Not available
AcO	Acetoxy	NMR	Nuclear magnetic resonance
Bn	Benzyl	Ph	Phenyl
BnO	Benzyloxy	PTC	Phase transfer conditions
BuLi	Butyllithium	R_f	Retention factor
CER-MOP	Cerium(IV)sulfate molybdate phosphoric acid	r.t.	Room temperature
CO₃	Carbonate	SAH	Sodium bis(2- methoxyethoxy)aluminium hydride
D.A.	Diels Alder	THF	Tetrahydrofurane
DBU	1,8-diazabicyclo[5.4.0]-7- undecene	TLC	Thin layer chromatography
DCM	Dichloromethane	TMS	Trimethylsilyl
DFC	Dry flash chromatography	TMSO	Trimethylsilyloxy
DME	Dimethoxyethane	TsOH	<i>p</i> -Toluenesulfonic acid
DMF	<i>N,N</i> -Dimethylformamide	UV	Ultraviolet
Eq.	Equivalents	<i>a priori</i>	Beforehand
g	Grams	<i>et al.</i>	(Et alii) And others
HCO₂	Formate	<i>in situ</i>	On site
HCl	Hydrochloric acid	<i>i-Pr</i>	<i>iso</i> -Propoxy
HMDS	Bis(trimethylsilyl)amide	<i>t</i>-Bu	<i>t</i> -Butoxy
Hz	Hertz		
IR	Infrared		
M	Molar		
MCPBA	<i>m</i> -Chloroperbenzoic acid		
MeCN	Acetonitrile		
MeLi	Methylithium		
mL	Milliliters		
mm	Millimeters		
mmol	Millimoles		
MOP	Molybdate phosphoric acid		
m.p.	Melting point		
MHz	Megahertz		

6. Appendix

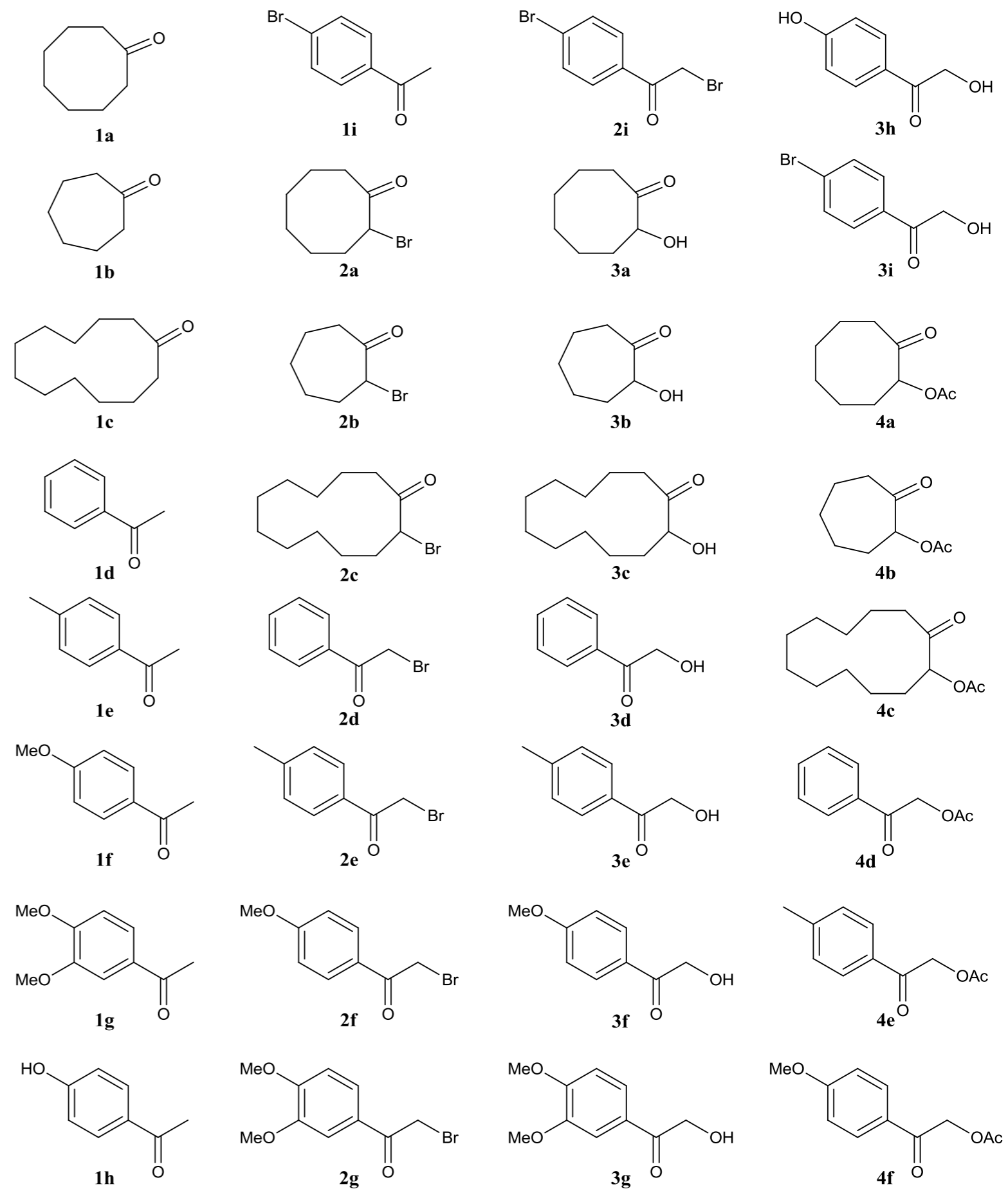

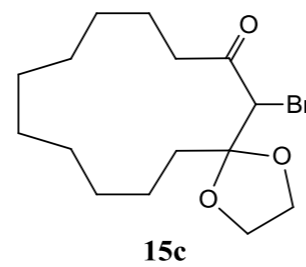
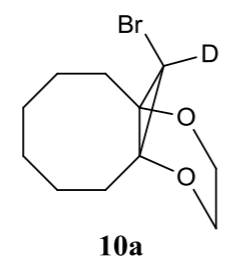
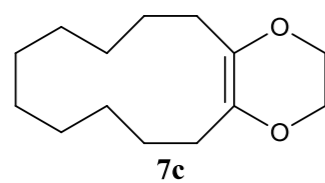
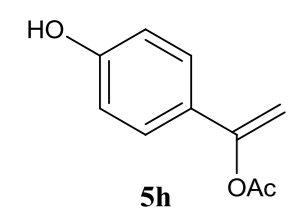
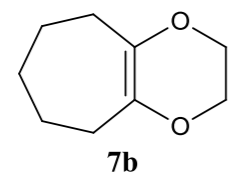
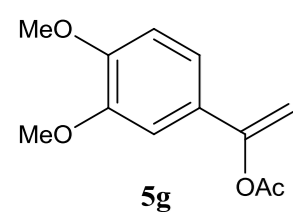
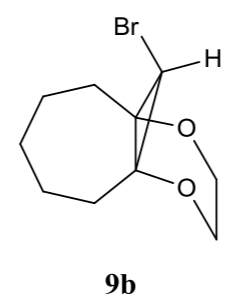
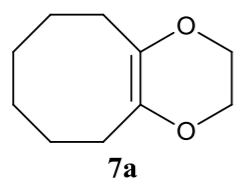
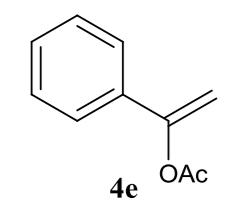
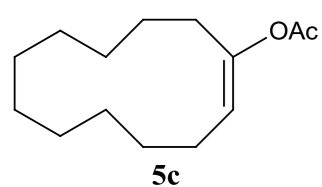
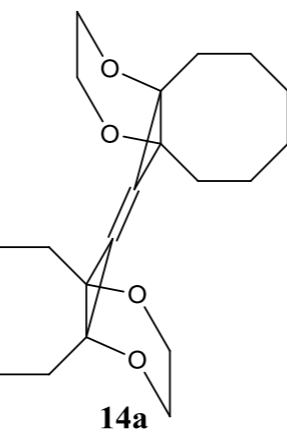
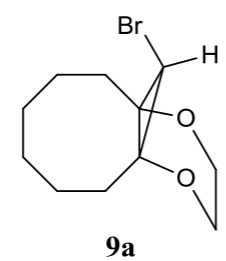
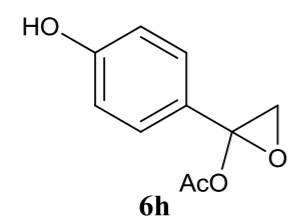
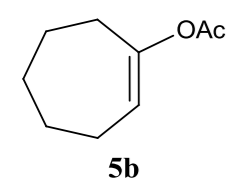
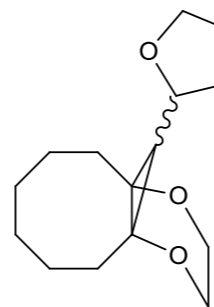
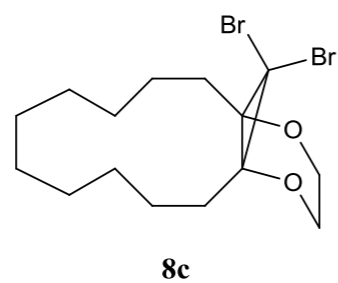
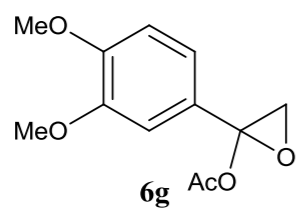
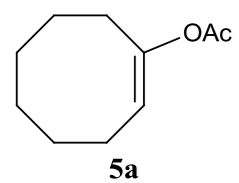
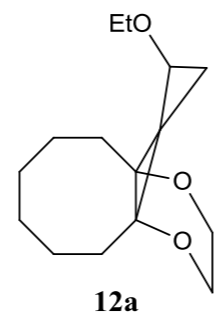
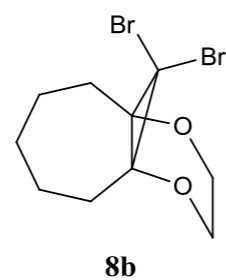
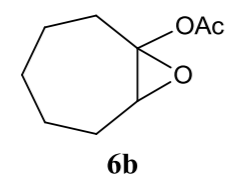
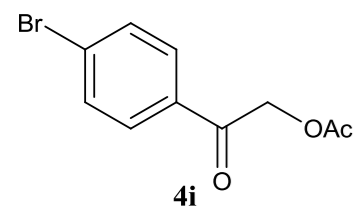
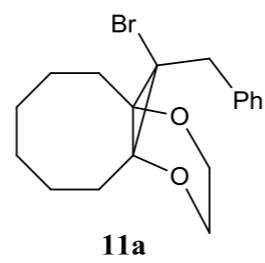
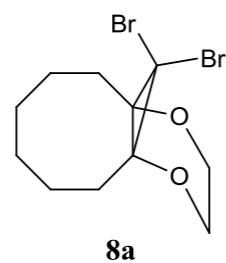
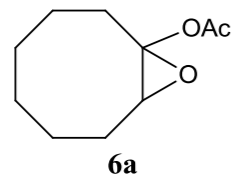
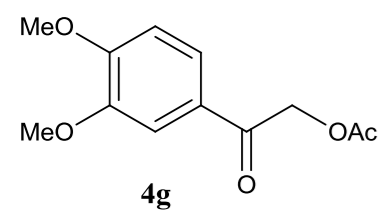

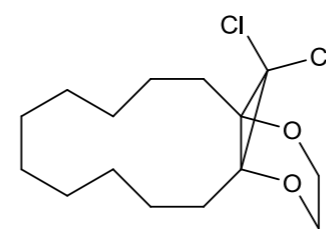

16c

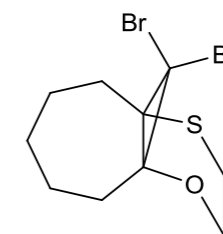

20b

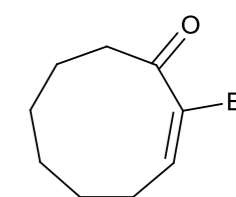

27a

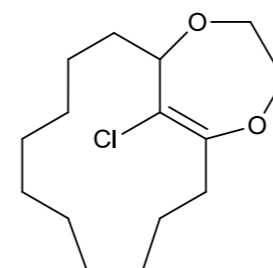

17c

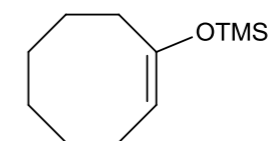

21a

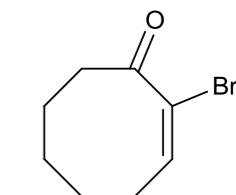

27b

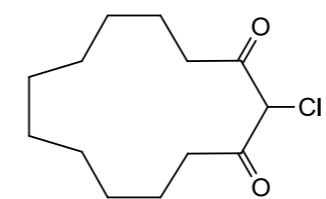

18c

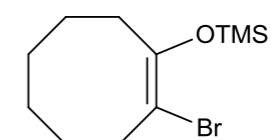

22a

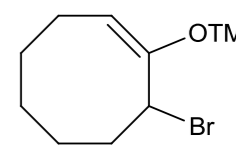

28a

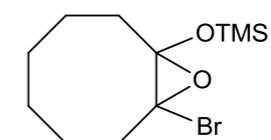

23a

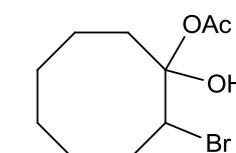

29a

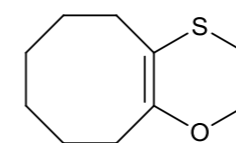

19a

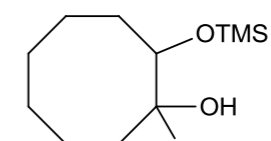

24a

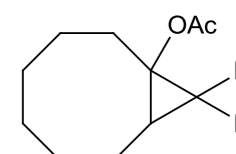

30a

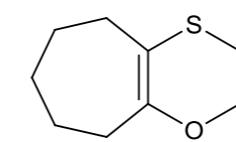

19b

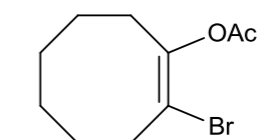

25a

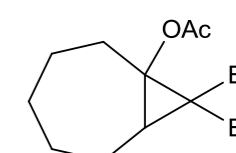

30b

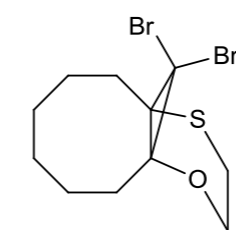

20a

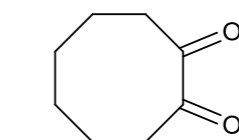

26a

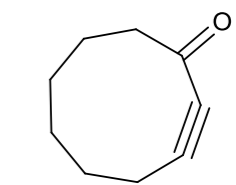

31a

7. References

- [1] E. Bakstad, *unpublished results*.
- [2] P. Müller, J. Pfyffer, *Chimia*, **1991**, *38*, 79-80.
- [3] P. Müller, N. Pautex, *Helv. Chim. Acta*, **1988**, *71*, 1630-1637.
- [4] M. N. Hopkinson, C. Richter, M. Schedler, F. Glorius, *Nature*, **2014**, *510*, 485-496.
- [5] L. Skattebøl, *J. Org. Chem.*, **1970**, *35*, 3200-3001.
- [6] L. K. Sydnes, E. Bakstad, In B. Halton (Series ed.), *Advances in Strain in Organic Chemistry*, London, Jai Press Inc., **1996**, *5*, 85-119.
- [7] P. Müller, N. Pautex, *Helv. Chim. Acta*, **1991**, *75*, 55-64.
- [8] J. Springer, *Master of science Thesis, Universiteit Amsterdam & UiS*, **2002**.
- [9] J. Arct, B. Migaj, *Tetrahedron*, **1981**, *37*, 953-956.
- [10] W. E. Billups, L. E. Reed, W. Casserly, L. P. Lin, *J. Org. Chem.*, **1981**, *46*, 1326-1333.
- [11] B. Halton, J. H. Bridle, E. G. Lovett, *Tetrahedron Lett.*, **1990**, *31*, 1313-1314.
- [12] R. Anet, F. A. L. Anet, *J. Am. Chem. Soc.*, **1964**, *86*, 525-526.
- [13] H. Kunz, M. Lindlig, *Chem Ber.*, **1983**, *116*, 220-229.
- [14] H. J. Abendrofii u. G. Henrich, *Angew. Chem.*, **1959**, *71*, 283.
- [15] S. R. Paulsen, *Angew. Chem.*, **1960**, *72*, 781-782.
- [16] R. Thieme, H. Lay, A. Oser, J. Lehmann, S. Wrissenberg, W. Boos, *Eur. J. Biochem.*, **1986**, *160*, 83-91.
- [17] B. Liessem, G. J. Glombitza, F. Knoll, J. Lehmann, J. Kellermann, F. Lottspeich, K. Sandhoff, *J. Biol. Chem.*, **1995**, *270*, 23693-23699.
- [18] C. Thiele, M. J. Hannah, F. Fahrenholz and W. B. Huttner, *Nat. Cell Biol.*, **2000**, *2*, 42-49.
- [19] E. Yoshida, H. Nakayama, Y. Hatanaka, Y. Kanaoka, *Chem. Pharm. Bull.*, **1990**, *38*, 982-987.
- [20] C. A. Thomas, S. G. Grant, B. R. Pflug, R. H. Getzenberg, B. W. Day, *J. Uro. Onc.*, **2008**, *26*, 378-385.
- [21] S. S. Jonnalagadda, E. Haar, E. Hamel, C. M. Lin, R. A. Magarian, *Bioorg. Med. Chem.*, **1997**, *5*, 715-722.
- [22] L. Skattebøl, L. Sydnes, *Tetrahedron*, **1974**, *42*, 3703-3706.
- [23] L. Skattebøl, *Tetrahedron*, **1961**, *2*, 167-172.
- [24] L. Skattebøl, *J. Org. Chem.*, **1966**, *31*, 2789-2794.
- [25] W. von E. Doering and P. M. LaFlamme, *Tetrahedron*, **1958**, *2*, 75-79.
- [26] L. Skattebøl, *J. Org. Chem.*, **1966**, *31*, 1554-1559.
- [27] L. Skattebøl, *Tetrahedron*, **1967**, *23*, 1107-1117.
- [28] P. Warner, I. S. Chu, *J. Org. Chem.*, **1984**, *49*, 3666-3668.
- [29] E. M. Arnett, M. A. Nichols, A. T. McPhail, *J. Am. Chem. Soc.*, **1990**, *112*, 7059-7060.
- [30] I. R. Fjeldskaar, P. Rongved, L. Skattebøl, *Acta Chem. Scand.*, **1987**, *B41*, 477-486.
- [31] J. S. Sande, *Master of Science Thesis, UiS*, **2011**.
- [32] R. O. Perez, *Bachelor of Science Thesis, UiS*, **2015**.
- [33] J. C. Lee, Y. H. Bae and S.-K. Chang, *Bull. Kor. Chem. Soc.*, **2003**, *24*, 407-408.
- [34] N. J. Turro, W. B. Hammond, *J. Am. Chem. Soc.*, **1965**, *87*, 3258-3259.
- [35] L. A. Paquette, I. Vilotijevic, J. Yang, D. Hilmey, *Synthesis*, **2003**, *12*, 1872-1874.
- [36] L. A. Paquette, Q. Zeng, *Tetrahedron Lett.*, **1999**, *40*, 3823-3826.
- [37] D. Y. Curtin, W. R. Proops., *J. Am. Chem. Soc.*, **1954**, *76*, 494-499.

- [38] L. A. Paquette, J. E. Hofferberth, In L. E. Overman (Series ed.), *Organic Reactions*, John Wiley & Sons Inc., **2003**, *62*, 477-567.
- [39] F. F. Wong, P. Chang, H. Lin, B. You, J. Huang, S. Lin, *J. Organomet. Chem.*, **2009**, *694*, 3452-3455.
- [40] G. M. Rubottom, J. M. Gruber, *J. Org. Chem.*, **1978**, *43*, 1590-1602.
- [41] C. Zhang, X. Zhao, *Synthesis*, **2007**, *4*, 551-557.
- [42] O. Onomura, J. M. William, M. Kuriyama, *Tetrahedron Lett.*, **2014**, *55*, 6589-6592.
- [43] K. Ganesan, A. K. Halve, C. K. Maurya, P. K. Gupta, P. A. Soni, *Tetrahedron Lett.*, **2015**, *56*, 2817-2819.
- [44] E. Bakstad, L. K. Sydnes., *Acta Chem. Scand.*, **1997**, *51*, 1132-1133.
- [45] L. Skattebøl, Y. Stenstrøm, M. Stjerna, *Acta Chem. Scand.*, **1988**, *42*, 475-483.
- [46] E. Bakstad in *Method for the synthesis of anthocyanins*, Pub. No.: US 2009/0111975 A1.
- [47] E. Bakstad, R. Sanchez, *unpublished results*.
- [48] Ø. Ulset, *Bachelor of Science Thesis, UiS*, **2016**
- [49] J. Gmehling, J. Menke, J. Krafczyk, K. Fischer, J. C. Fontaine, H.V. Kehiaian, In W. H. Haynes (Series ed.), *Handbook of Chemistry and Physics*, London, CRC Press, 2013, *94*, 6210- 6228.
- [50] M. S. Azevedo, G. B. C. Alves, J. N. Cardoso, R. S. C. Lopes, C. C. Lopes, *Synthesis*, **2004**, *8*, 1262-1268.
- [51] M. Chen, W. Zhang, Z. Ren, W. Gao, Y. Wang, Z Guan, *Sci. China Chem.*, **2017**, *60*, 761-768.
- [52] J. Sheng, X. Li, M. Tang, B. Gao, G. Huang, *Synthesis*, **2007**, *8*, 1165-1168.
- [53] D. W. Cho, R. Parthasarathi, A. S. Pimentel, G. D. Maestas, H. J. Park, U. C. Yoon, D. D. Mariano, S. Gnanakaran, P. Langan, P. S. Mariano, *J. Org. Chem.*, **2010**, *75*, 6549-6562.
- [54] G. Rosini, R. Ballini, M. Petrini, *Synthesis*, **1985**, *3*, 269-271.
- [55] A. C. Rojas, J. K. Crandall, *J. Org. Chem.*, **1975**, *15*, 2225-2229.
- [56] M. G. Moloney, J. T. Pinhey, M. J. Stoermer, *J. Chem. Soc.*, **1990**, *10*, 2645-2655.
- [57] Y. Onishi, Y. Nishimoto, M. Yasuda, A. Baba, *Org. Lett.*, **2011**, *13*, 2762-2765.
- [58] B. C. Kang, S. Y. Shim, D. H. Ryu, *Org. Lett.*, **2014**, *16*, 2077-2019.
- [59] Y. Zhu, L. Shu, Y. Tu, Y. Shi, *J. Org. Chem.*, **2001**, *66*, 1818-1826.
- [60] I. R. Fjeldskaar, L. Skattebøl, *Acta Chem. Scand.*, **1991**, *45*, 410-417.