

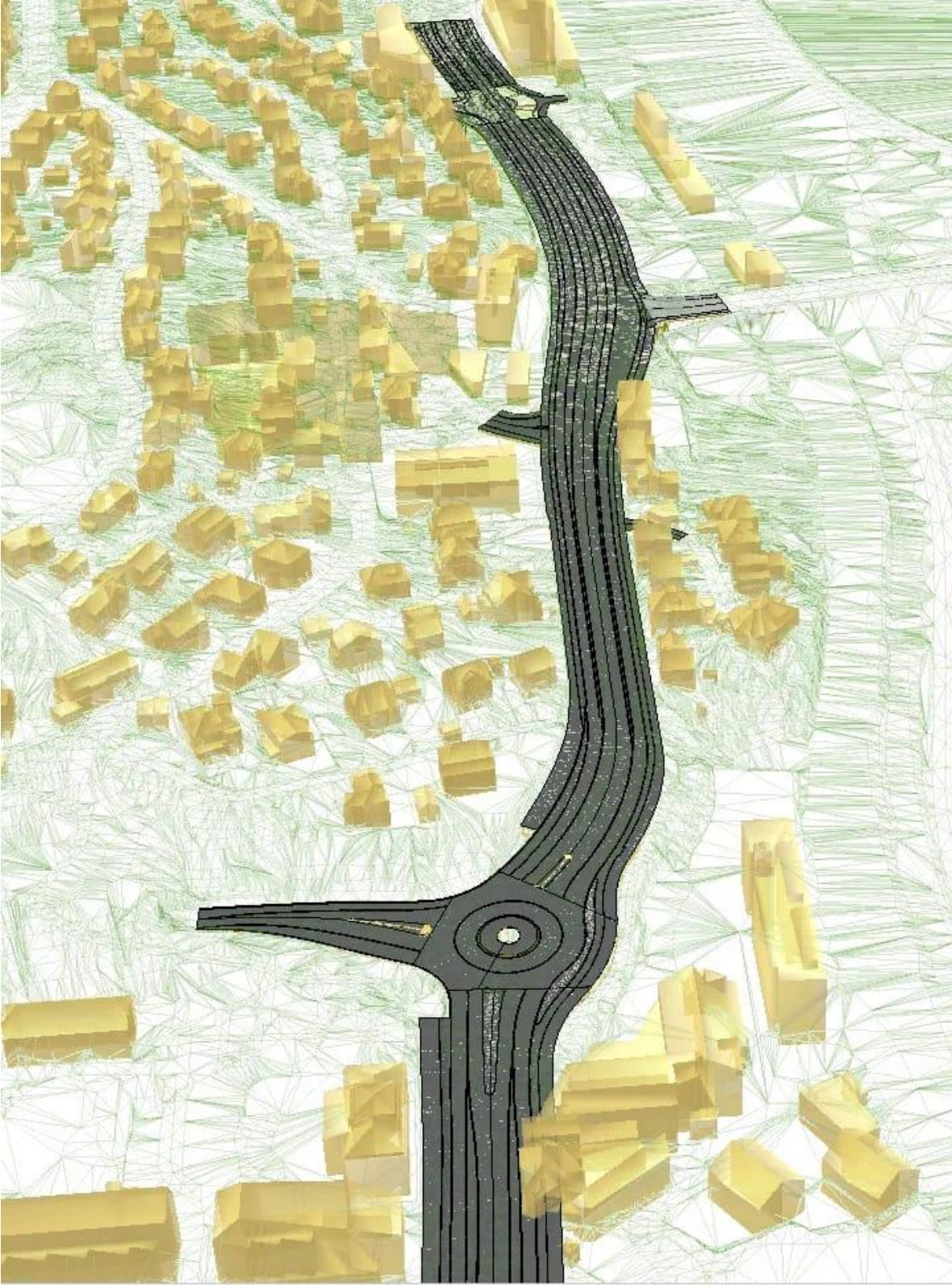

FACULTY OF SCIENCE AND TECHNOLOGY
MASTER'S THESIS

Study programme: City and Regional Planning	The spring semester, 2023 Open / Confidential
Author: Łukasz Bartłomiejczyk	
Supervisor at UiS: Cristian Tosa Co-supervisor: Ari Krisna Mawira Tarigan External supervisor(s): Katrine Skare Bakka	
Thesis title: Bussveien between Hillevåg and Musegata in Stavanger, Norway	
Credits (ECTS): 30	
Keywords: Bussveien, FV44, BRT, 3D model, walking time analysis, Stavanger, stakeholder engagement	Pages: 109 + appendix: 98 Stavanger, 12.06.2023



Abstract

This paper aims to present principles of the Bus Rapid Transit (BRT) system together with its impact on cities such as improvement of travel speed of buses, increased ridership, and higher reliability of public transportation on the example of Stavanger.

Implementation of Bussveien in Stavanger will lead to changes in the city. One of them is the location of bus stops. For the section between Hillevåg and Musegata, the walking time analysis was done for the new proposal and compared with existing conditions to find out that Bussveien will extend walking time to bus stops.

Lastly, 3D modelling software Novapoint was investigated for its utility in the planning process such as improvement of accuracy and stakeholders cooperation to be found out that it has a slightly positive impact. Additionally, a 3D model of Bussveien for a given section was constructed in Novapoint to find out that the software is not very accessible for novice users because of its lack of intuitiveness and prevalence of errors.

The motivation behind this project, and particularly 3D modelling in Novapoint, was the author's interest in learning the use of software which can help later in his professional career.

Acknowledgements

In the first place I wanted to thank Shazia Ali Zade from Rogaland County, who helped me a lot with technicalities in Novapoint. Without her it would not be possible for me to make the 3D model. Second person is my supervisor Cristian Tosa who helped me with giving the overall shape of my thesis and giving a direction for work. Last but not least, I want to thank my sister Iga Bartlomiejczyk and my girlfriend Frida Yee who helped me with proof reading to ensure that the project is understandable and written in proper English.

Table of Contents

1. Introduction	12
1.1 BRT system	13
1.1.1 Pedestrians' safety (zebra crossing with islands)	14
1.1.2 Cycling infrastructure and safety	14
1.1.3 Environmental impact and emergency vehicles	15
1.1.4 Property prices impact	16
1.1.5 Weather impact on ridership	17
1.1.6 Summary	18
1.2 Bussveien in Stavanger area	19
1.3 Location of the project area	21
1.4 Surroundings	25
1.5 Problem statement and research questions	26
2. Methodology	27
2.1 Walking time analysis	27
2.2 3D modelling	28
3. Case Study – Bussveien in Stavanger	30
3.1. Principles of Bussveien	30
3.2. Testimonials	34
3.3. Walking time analysis	36
3.3.1 Sidewalks network	36
3.3.2 Walking time analysis – existing	40
3.3.2 Walking time analysis - new	41
3.3.3 Limitations	42
3.3.4 Conclusion	42
3.4 3D model	43
3.4.1. Overview of Novapoint and AutoCAD software	43
3.4.2 Data Collection and Preparation	44
3.4.2.1 Data Collection	44
3.4.2.2 Data Preparation	45
3.4.3 Road Design	51
3.4.3.1 Line task	51
3.4.3.2 Road task	52
3.4.3.2.1 Surface properties	54
3.4.3.2.2 Cross section and boundary lines	57
3.4.4 Intersection Design	62
3.4.4.1 Design principles and standards for intersections	62
3.4.4.2 Signal regulated T – intersection	62
3.4.4.3 Exit to Høylandsgata and Skjærebergveien	69
3.4.4.4 Roundabout design – South	73
3.4.4.5 Roundabout north	87
3.4.4.6 Islands and median strips (traffikøyer and midtdeler)	93
4. Discussion	97

4.1	Model errors	97
4.2	Superelevation	98
5.	<i>Conclusion</i>	102
6.	<i>References</i>	104

Table of Figures

Figure 1 "Fly forurensert mest" (Flights pollute most) (2022) Rostvik, H.....	16
Figure 2 Center located bus road (Midtstilt kollektivgate) (Rogaland County, 2018)	19
Figure 3 Map with status of sections. (Kart med status delstrekninger) (Rogaland FK, 2023)	20
Figure 4 Location of the project area on map of south Norway and Stavanger area. North orientated. (Norgeskart, n.d.).....	21
Figure 5 Roads in the project area. North orientated. (Norgeskart, n.d.).....	22
Figure 6 Graphic presentation of AADT value for Stavanger. Black square indicates project area. (authors)	23
Figure 7 Bus routes and railway in the project area. North orientated. (Norgeskart, n.d.)	24
Figure 8 Surroundings of project area (authors work)	25
Figure 9 Process of construction isochrones in QGIS	28
Figure 10 Process of construction 3D model in Novapoint	28
Figure 11 Not perfect location of center lines for FV44 with correct placement of boundary lines.....	29
Figure 12 View on bus prioritized, signal-controlled roundabout in Mariero (authors picture)	31
Figure 13 Situation when bus is driving on bike lane when approaching bus stop (authors picture)	32
Figure 14 Bike box on bus prioritized roundabout in Mariero (authors picture)	33
Figure 15 Answers from road planners in Rogaland County concerning perception of the added value of Novapoint	34
Figure 16 Answers from road planners concerning specific capabilities of Novapoint	34
Figure 17 Existing bus stops and road and sidewalks network	37
Figure 18 New location of bus stops and road and sidewalks network.....	38
Figure 19 Walking time analysis for existing conditions (author's work)	40
Figure 20 Walking time analysis for new conditions (author's work)	41
Figure 21 Overview of steps in Novapoint for 3D model construction.....	43
Figure 22 Tools used in Novapoint	43
Figure 23 Tools used in AutoCAD	44
Figure 24 2D proposal in dwg from Rogaland County (west orientated)	44
Figure 25 3D model for existing roads, roofs and contour lines made based on SOSI files (view from south)	45
Figure 26 Eksisterende terreng SOSI	46
Figure 27 3D buildings with Strømsbrua	47
Figure 28 Prepared dwg file from SOSI.....	48
Figure 29 Ready to work dwg file with coordinates	49
Figure 30 Diagram of steps for Line task	51
Figure 31 Error message "Ikke OK!" while picking line in horizontal alignment.	51
Figure 32 Diagram for steps of Vegoppgave	52
Figure 33 Predefined road gate based on CL-FV44	53
Figure 34 Surfaces for FV44/sør	54

Figure 35 Change of surface properties in Konverteringsregler for FV44/sør	55
Figure 36 Different types of graphic presentation of 3D model in Novapoint	56
Figure 37 FV44 and north roundabout, in Default colors	56
Figure 38 Surface properties for bike lane, roundabout north (left) and FV44 (right)	57
Figure 39 Window Line as surface boundary, showing how boundary lines are implemented in 3D model	58
Figure 40 List of all boundary lines for FV44	59
Figure 41 Location of boundary lines on cross section of FV44 sør, profile 00	59
Figure 42 All steps for road construction starting from new project until construction of intersections	60
Figure 43 Location of boundary lines for T – intersection	63
Figure 44 Strømsbrua 3d model after use of avgr. Strømsbrua in and ut	63
Figure 45 Strømsbrua with proper shape and beginning and end.....	64
Figure 46 3D model of Strømsbrua with sidewalks.....	64
Figure 47 On the left side there is cut median strip, so it has same level as lane and on the right side – uncut median strip.....	65
Figure 48 Lines for rounding of median strips and traffic island for T – intersection, location on FV44	65
Figure 49 3D model of T-intersection (view from south)	66
Figure 50 3D model of T-intersection (view from top).....	67
Figure 51 All steps of construction T-intersection	68
Figure 52 View of connection between Høylandsgata and FV44 (view from east)	70
Figure 53 View of connection between Høylandsgata and FV44 (view from top)	71
Figure 54 View of connection between Skjærebergveien and FV44 (view from south).....	72
Figure 55 View of connection between Skjærebergveien and FV44 (view from top)	72
Figure 56 Different elements of a roundabout (Ulike elementer i en rundkjøring) (V121, 2014)	74
Figure 57 Prepared circulation area of roundabout (view from south).....	75
Figure 58 Location of lines avgr. rund. sør FV44 sør til Tunnelen midt and avgr. Tunnelen til FV 44 sør	76
Figure 59 Level difference between FV44 sør, Hillevågstunnelen and rund. sør sentraløya (view from FV44 sør)	76
Figure 60 Leveling between FV44 sør, Hillevågstunnelen and rund. sør sentraløya (view from FV44 sør)	76
Figure 61 Location of rund. utvidelse tunnelen til FV44 sør	77
Figure 62 Finished connection of Hillevågstunnelen, FV44 sør and roundabout (view from FV44 sør).....	78
Figure 63 Boundary lines between FV44 and Hillevågstunnelen.....	79
Figure 64 80 cm gap between roundabout and existing lane to Hillevågstunnelen (view from tunnel).....	79
Figure 65 80cm gap between roundabout and existing lane to Hillevågstunnelen in vertical alignment.....	80
Figure 66 Finished connection of Hillevågstunnelen, FV44 and roundabout (view from south).....	80

Figure 67 Boundary lines between FV44, FV44 sør and roundabout	81
Figure 68 Almost finished connection between roundabout, FV44 sør and FV44	82
Figure 69 Connection between roundabout, FV44 sør and FV44 (view from FV44 sør)	83
Figure 70 Ready roundabout (view from south)	84
Figure 71 Ready roundabout (view from top)	85
Figure 72 Location of rund. nor v. and h. kjørefelt (closer to CL - FV44) and rund. nor. v. and h. innkjøring	88
Figure 73 Rund. nor. h. kjørefelt after boundary of rund. nor. h. innkjøring	89
Figure 74 Ready roundabout north (view from south)	90
Figure 75 Ready roundabout north (view from top)	91
Figure 76 Example of ready traffic island (trafikkøya Hillevågstunnelen)	94
Figure 77 Full list of all line tasks for median strips and traffic islands	94
Figure 78 Location of traffic islands and rounding of median strips on the southern roundabout	95
Figure 79 Location of traffic islands and rounding of median strips on T-intersection	96
Figure 80 Location of traffic islands and rounding of median strips on the northern roundabout	96
Figure 81 Typical fatal error in Novapoint	97
Figure 82 Operasjon feilt - error occurring when trying to safe	98
Figure 83 Cross fall, one-sided drop (Tverrprofil, ensidig fall (overhøyde)) (V120, 2014, p.37)	98
Figure 84 Width extension by default is not switch on in Novapoint	99
Figure 85 Principle sketch for widening for a 2-lane road	99
Figure 86 Width extension switched on after constructing whole model	100
Figure 87 Calculated cross slopes depending on profile of road	101
Figure 88 Difference of levels when superelevation implemented for FV44, view from Strømsbrua	101

List of Tables

Table 1 Choice of time analysis tool	28
Table 2 Walking time analysis for existing conditions (author's work)	40
Table 3 Area of each isochrone for existing conditions	41
Table 4 Difference of area of each isochrone (new vs old)	42
Table 5 Where to find what in appendix for FV44 and FV44 sør	61
Table 6 Where to find what in appendix for T-intersection	69
Table 7 Where to find what in appendix for two exits	73
Table 8 Where to find what in appendix for elements of roundabout south	86
Table 9 Where to find what in appendix for roundabout north	92

All pictures are north orientated if not stated differently. For pictures of 3D models, both in report and appendix two views were used. The first one is the view *from south* – this view is the default view on the model, and when switched on, gives the same angle of view. In that case N is in blue color. Second is *view from top* and is simply viewed as 2D, when the user changes angle of view, N becomes red.

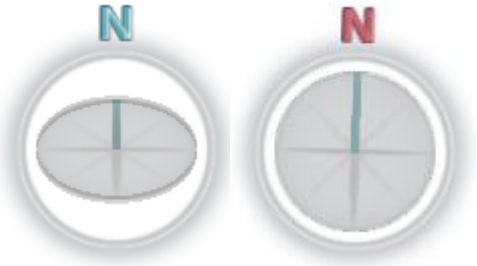

1. Introduction

Climate is rapidly changing primarily due to human activity, especially the usage of fossil fuels. To combat this, more and more governments employ strategies whose aim is to stop the raising of average global temperature. Norway is a country whose economy is dependent on its oil extraction and as a result it is a country that has very high CO2 emissions per capita when taken into account export of CO2 (Our World in Data, 2023). However, Norway is also implementing procedures that will balance the country's impact on the natural environment.

Norway's most ambitious plan is to become climate neutral by 2030. In order to achieve that there is a need to introduce strategies not only on a national level but also on a regional one.

In cooperation between Rogaland County, Stavanger municipality and other cities in the region a project called Bymiljøpakken was created. Bymiljøpakken is a package of many different infrastructural projects whose common goal is to increase the number of people who use public transportation, bikes, and walking and simultaneously achieve no rise of car traffic in the region. As stated in the program of actions - *in urban areas, greenhouse gas emissions, traffic jams, air pollution and noise must be reduced through efficient land use and by the growth in passenger transport being taken up by public transport, cycling and walking. (I byområdene skal klimagassutslipp, kø, luftforurensning og støy reduseres gjennom effektiv arealbruk og ved at veksten i persontransporten skal tas med kollektivtrafikk, sykling og gange).* (Handlingsprogram 2023-2026, 2022, p.3). Main project included in Bymiljøpakken is Bussveien (in literal translation from Norwegian *the bus road*, Bussveien is proper name and will be used in this paper) for whose construction 35% of whole Bymiljøpakken budget is planned, resulting in cost of 11.55 billion NOK for years 2023-2026 (Handlingsprogram 2023-2026, 2022, p.10) with total length of 50km (Jack,2022). That cost does not include already constructed parts.

The project will consist of three main parts. The first part is a literature overview concerning bus roads, the main idea, their impact on cities and people. In the second part walking time analysis for existing and new conditions will be conducted and compared to find out how new layout of bus stops influence waking time. Lastly, testimonies from road planners from Rogaland County will be collected to see how Novapoint changed added value in the planning process and a 3D model of the section of Bussveien will be constructed to validate and verify testimonies. The project will end with conclusion.

1.1 BRT system

“Bus Rapid Transit (BRT) is a high-quality bus-based transit system that delivers fast, comfortable, and cost-effective urban mobility through the provision of segregated right-of-way infrastructure, rapid and frequent operations, and excellence in marketing and customer service. BRT essentially emulates the performance and amenity characteristics of a modern rail-based transit system but at a fraction of the cost.” (Wright and Hook, 2007, p. 1)

The definition provided above indicates that Bus Rapid Transit (BRT) aspires to offer service quality comparable to rail systems by enhancing the delivery of bus-based services. Levinson et al. (2003) identify the following key characteristics that contribute to the superior quality of BRT systems:

A. Travel Routes – these consist of mixed lanes, curb bus lanes, and busways in cities and dedicated bus-only roads, tunnels, highway lanes, and bridges. Improved travel speeds and reliability resulting from these routes may lead to increased occupancy of public transport.

B. Transit Hubs - BRT systems offer upgraded infrastructure compared to standard bus stops, with features such as platforms, enhanced shelter, advanced information systems, and additional amenities. These improvements can attract more passengers due to increased comfort and reduced boarding times, facilitated by elements like level boarding platforms.

C. Transit Vehicles - While BRT systems can utilize conventional diesel buses, both standard and articulated, there is a growing tendency toward innovative vehicle designs. Examples include environmentally friendly vehicles, dual-mode (diesel-electric) buses for tunnel operations, low-floor buses, vehicles with more and wider doors, and distinctively designed BRT-specific vehicles for branding purposes. Similar to transit hubs, high-quality vehicles can boost ridership through improved comfort and reduced boarding times with features like multiple doors or level access.

D. Smart Transportation Systems - BRT systems often incorporate advanced technologies such as automatic vehicle location systems, passenger information systems, and transit prioritization systems at signalized intersections, controlled tunnel or bridge entrances, toll booths, and freeway ramps. These technologies can enhance ridership by increasing travel speeds, improving reliability, and providing better passenger information.

E. Service Schedules - BRT systems typically offer high-frequency service, with a combination of express and local routes. Notably, many networks extend beyond dedicated

routes and into local streets, reducing the need for passengers to transfer at transit hubs. High service frequency is likely to have a significant impact on attracting riders.

To sum up, a perfect BRT system would be one with physically separated bus lanes, where on/off boarding is done in space covered from weather, with low emission buses with different smart solutions (like GPS tracking available for everyone) and which shuttles frequently. Institute for Transportation & Development Policy which is an international organization working on, among others, more sustainable cities and better urban transportation systems provides a scorecard on base of which different BRTs are graded. Criteria include bus prioritizing, number of routes, departure frequency, buses' emissions and also infrastructure around such as bike lanes and integration with different modes of transportation (ITDP, n.d.).

1.1.1 Pedestrians' safety (zebra crossing with islands)

Norway has a goal called *Nullvisjonen*, which directly translates to zero vision. It aims to reduce the number of people killed or hard wounded down to a maximum 350 per year by 2030, and finally reach 0 people killed in traffic accidents by 2050 (Regjeringen, 2023). To achieve that safety of both drivers and pedestrians needs to be improved and implementing BRT could help achieve this goal. As research indicates, safety on routes where BRT systems function is considerably enhanced by employing middle-lane arrangements, restricting left turns, and implementing signal-controlled pedestrian crossings at mid-block locations, complete with refuge islands (Carvero, 2013). In this project, mid-blocks are at the same time median strips, since bus stops are located in the middle of the road and bus lanes are physically separated from the rest of traffic. Additionally, researches from around the world show decline in accidents where pedestrians were injured – by 88 percent in Bogota (Hidalgo, Yepes, 2005) and 64 percent in Istanbul (Yazici et al. 2013) because of the implementation of BRT.

1.1.2 Cycling infrastructure and safety

Another group of traffic participants whose safety needs to be ensured are cyclists. Suitable infrastructure is an important means to reduce accidents where cyclists are wounded. One of the factors which have a significant impact on cyclists is the type of intersection. Although roundabouts are generally considered a safer intersection type due to lowering speed of entering vehicles, that is not the case when it comes to bike safety. Study in Belgium showed that implementing roundabouts increases the number of severe injury crashes with cyclists, regardless of the design type of cycle facilities (S. Daniels et al. 2009. p. 148). The same study found that the worst effect on safety is when roundabouts are replacing signal-controlled intersections.

The second safety measurement are ASLs. The study from Portland, Oregon, found out that their implementation increased safety in the city and 77 percent of cyclists responded that they feel safer on junctions (Dill & Monsere, 2012). It is important since a study done in San Francisco Bay Area presented that feeling of safety or lack of safety while biking was an important factor for people when choosing mode of transportation, although it was only impacting people who do not use bikes frequently (Sanders, 2015).

1.1.3 Environmental impact and emergency vehicles

Another important field which is influenced by BRT is environment and emergency vehicles. It might seem strange to put them together, but they are connected because of the increase of speed for vehicles on bus lanes - vehicles omit traffic jams and congestions and thus smaller pollution coming from congestion. That is the reason why emergency vehicles can use bus lanes to reach faster people in need. Such solution of emergency vehicles using bus lane is implemented already in Stavanger.

A study in Seoul has shown that after implementing 70 km of new separate bus lane, buses speed doubled from 11 to 22 km/h (Cervero & Kang, 2011). Another study presented that in Bogota average speed increased to 27 km/h from 15 km/h (Cain et al., 2007). Similar numbers got Hidalgo and Graftieaux (2008) when studying BRT systems in 11 cities in Asia and America (increase from 14.5 km/h to 26 km/h).

The same system also helps to cut down time needed for emergency vehicles to reach their destination and thus potentially save lives.

Higher speed and omitting traffic jams make public transport more reliable, especially during peak hours. Also, those factors can lead to more people using public transport, which shows study done in Charlotte, North Carolina, USA. The study found that there is strong correlation between reliability of public transport and ridership especially during morning peak hour (Pulugurtha et al, 2022).

Another study done in the Chicago metropolitan area between 2002 and 2010 looked at how ridership changed while the bus tracking system was introduced. When taken into account variables like gas prices and weather, it was found that such system increases ridership modestly by an average of 126 passengers on route. Worth noting are limitations of study which includes limited awareness of system among citizens and limited access to technology. Currently use of smartphones and internet is much more prevalent than in first decade of 2000 (Tang & Thakuriah, 2012).

Higher ridership generally means a decline in private cars. Generally, because it can be caused also by bad weather when normally people would take bikes. When the occupancy rate is high it is more environmentally friendly to use public transport when taken into

account CO2 per passenger per km as presented in the figure below. It is important to remember that there are also other components which influence data on the chart. Source of energy of vehicles, weights and year of production have important role in number of emissions.

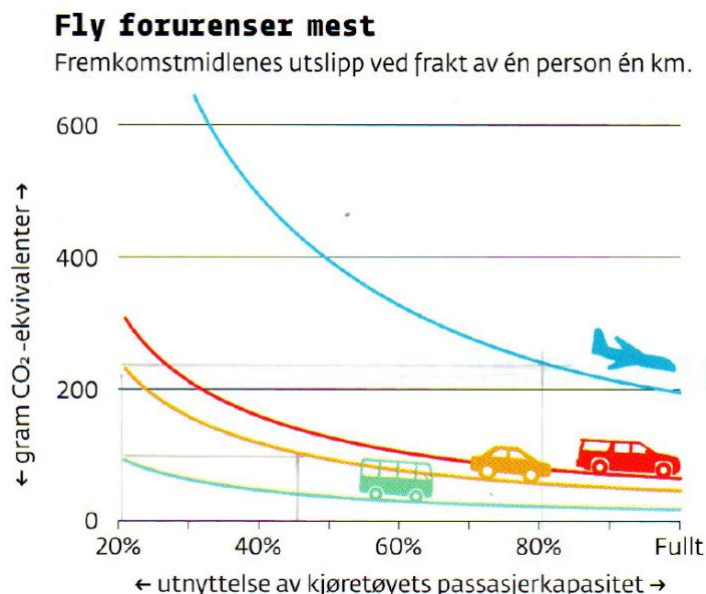

Figure 1 "Fly forurenses mest" (Flights pollute most) (2022) Rostvik, H

Not only can pollution drop due to better public transport offer but also noise pollution and thus overall life quality may improve.

1.1.4 Property prices impact

Construction of the new BRT system impacts different aspects of the city. The value of real estates which are close to new or better transportation possibilities is one of them. Commuting to school and work is one of the most basic and mundane activities in most people's lives, so house prices are affected by it. There are limited studies on the European real estate market affected by BRT, therefore impact on markets from the US and Colombia will be presented.

One study from Santa Clara County in California showed that property value near rail transit stations increased. This has a positive impact on different stakeholders such as local government and property owners. Increased property value means increased property tax revenue (Cervero & Duncan, 2002).

Another study from Bogota, Colombia shows that (...) for every 5 min of additional walking time to a BRT station, the rental price of a property decreases by between 6.8 and 9.3%

after controlling for structural characteristics, neighborhood attributes and proximity to the BRT corridor (Rodriguez & Targa, 2004, p.1)

Although there are no papers concerning the BRT system influencing the European property market, there is some research on metro and railway impact. It is still relevant since BRT system tends to be 10 to 100 times cheaper to construct than metro system with similar features (Wright & Hook, 2007, p.1). Study from Lisbon, Portugal shows that there is a significant property value increase when a metro station is nearby (Martinez & Viegas, 2009).

All the presented papers show that the BRT system has a positive and strong impact on property values. Better connection to land is highly valued for residents and businesses even in heavily car orientated countries like the USA.

1.1.5 Weather impact on ridership

The last factor which has an impact on ridership is weather. This is specifically relevant for Stavanger since rain and strong wind are common for the area. For the purpose of this chapter, research from cities with similar climate like in Norway were reviewed and papers concerning more exotic climate, like from Australia or Southern China, were omitted.

Research from Nova Scotia, Canada (Spinney & Millward, 2011) presented that weather conditions have a significant impact on overall physical activity, the more uncomfortable weather (in terms of thermal comfort, wind and precipitation) the more sedentary people get. This may cause people to be less willing to use public transport to commute to work or school, as it is necessary to travel a certain distance to the bus stop on foot. Study from Dublin (Hofmann & O'Mahony, 2005), where climate is quite similar to Stavangers one, shows just slightly smaller ridership rate on rainy days, which could be surprising. The limitation of this research is that only users using magnetic cards while boarding were counted and not the number of transactions of tickets onboard. Another study in Chicago (Tang & Thakuria, 2012) showed significant ridership decrease for rainy and snowy days but also during summer when high temperatures occurred. Lower ridership with higher temperatures can be connected to more people switching to cycling and not cars like in rainy weather (Sabir, 2011). Generally, temperature conditions have lower impact on ridership than precipitation (Böcker, Dijst & Prillwitz, 2013).

Last weather condition having an impact on ridership is wind, although there is very limited research on that. Study from Chicago (Guo, Wilson & Rahbee, 2007) (also called Windy City)

shows a significant decrease of ridership due to windy weather.

1.1.6 Summary

This subchapter presented the concept of Bus Rapid Transit (BRT) system as cost-effective, comfortable and fast bus-based public transportation, which is an alternative to light railway and metro systems. The crucial characteristics of BRT include dedicated bus-only roads and well-constructed transit hubs which can give a shelter to travelers. Low floor buses operating allow easy and fast embark-disembark for everyone and different smart solutions like GPS tracking allows to see real-life location used not only to see if buses are on time but also, in some cases, to steer the traffic lights. Along with a proper service schedule with more departures in rush hours, BRT can provide reliable transportation to the cities. Like with every big infrastructural project, different aspects need to be considered so in the end the BRT system fulfills its role.

The safety of pedestrians and cyclists will be improved by constructing bike lanes and refuge islands for crossing the roads and separating buses from them. This could not only reduce the number of accidents but also lead to more people using bikes instead of cars, which is the ultimate goal of BRT.

Reducing the number of cars and providing separate lanes for buses results in higher travel speed which means less delays and thus more reliability and more people using public transport which could result in snowball effect once it's done in the smart way. This will also result in less pollution and noise pollution, faster speed for emergency vehicles and rising overall quality of life.

Higher quality of life appeals to more people to live in proximity to BRT systems thus raising value of real estate which obviously is good for homeowners but not necessarily for people whose rents will increase as a result. Higher value can (depending on tax law) result in higher tax collected by cities which can be further spent on development of cities.

Lastly, usage of BRT depends on weather and climate of location, thus it is important to provide good quality transit hubs and bus stops along with quality buses (equipped in AC for summers and good heating for winters) so weather impact on ridership is mitigated as much as possible.

Once all aspects are addressed when planning and constructing the BRT system, then it will result in overall higher quality of life in cities where pollution

1.2 Bussveien in Stavanger area

Bussveien is a type of road where buses drive on separate lanes and are prioritized on intersections. Additionally, along the road are located separate lanes for cyclists. In the picture below - cross section of Bussveien with preferred dimensions (preferred while taking into account the width of the available area).

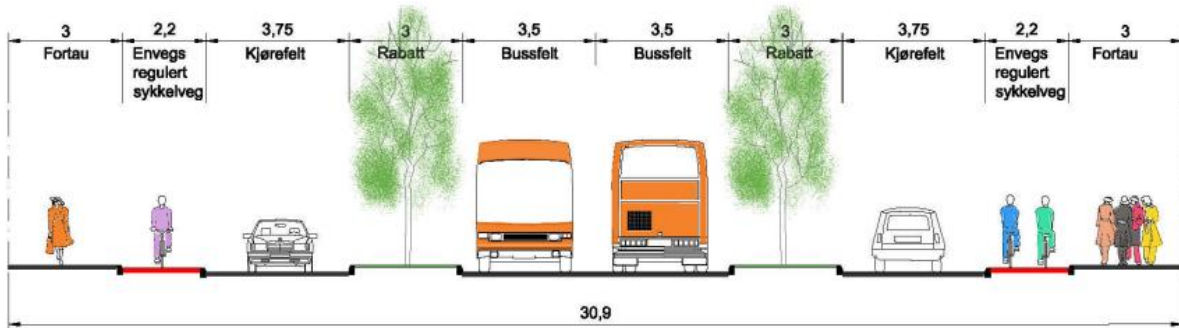

Figure 2 Center located bus road (Midtstilt kollektivgate) (Rogaland County, 2018)

The idea of Bussveien is not new - the first section was constructed in Jåsund in Sola municipality in 2013 (Munkvik, 2013). Since then, the network of Bussveien has increased by 7 new sections and three more in construction for the time of writing (May 2023). In the picture below - current map of parts of Bussveien with status of different sections

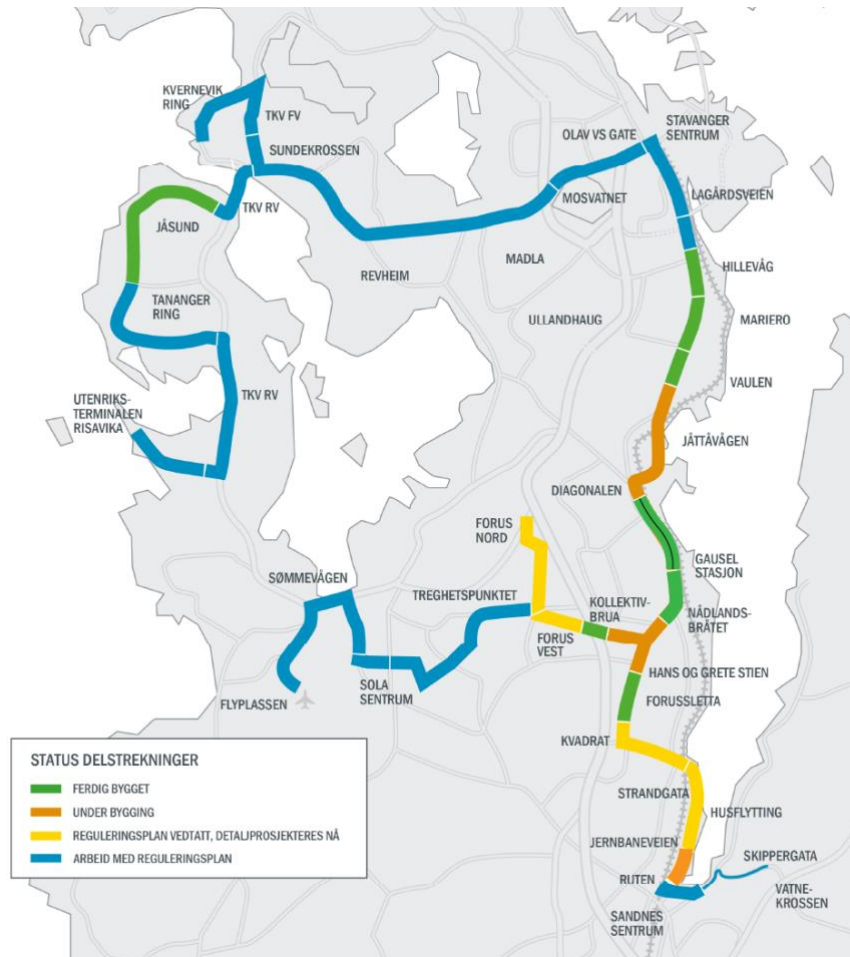

Figure 3 Map with status of sections. (Kart med status delstrekninger) (Rogaland FK, 2023)

Bussveien is divided to four corridors:

- Corridor 1: Mosvatnet - Stavanger center – Forus – Sandnes center
- Corridor 2: Risavika - Mosvatnet
- Corridor 3: Ruten - Vatnekrossen
- Corridor 4: Forus – Sola center – Stavanger airport Sola (Handlingsrom, 2018)

One of the remaining sections of corridor 1 is the part between Hillevåg and Stavanger center which is “an absolutely crucial part (en helt avgjørende brikke)” (Handlingsprogram 2023-2026, 2022, p.16). The importance of this section comes from its location – proximity to the city center and connection between the eastern part of Stavanger with the southern one.

1.3 Location of the project area

As mentioned before, the project area is located in Stavanger, Norway. On maps below is presented the location of the project.

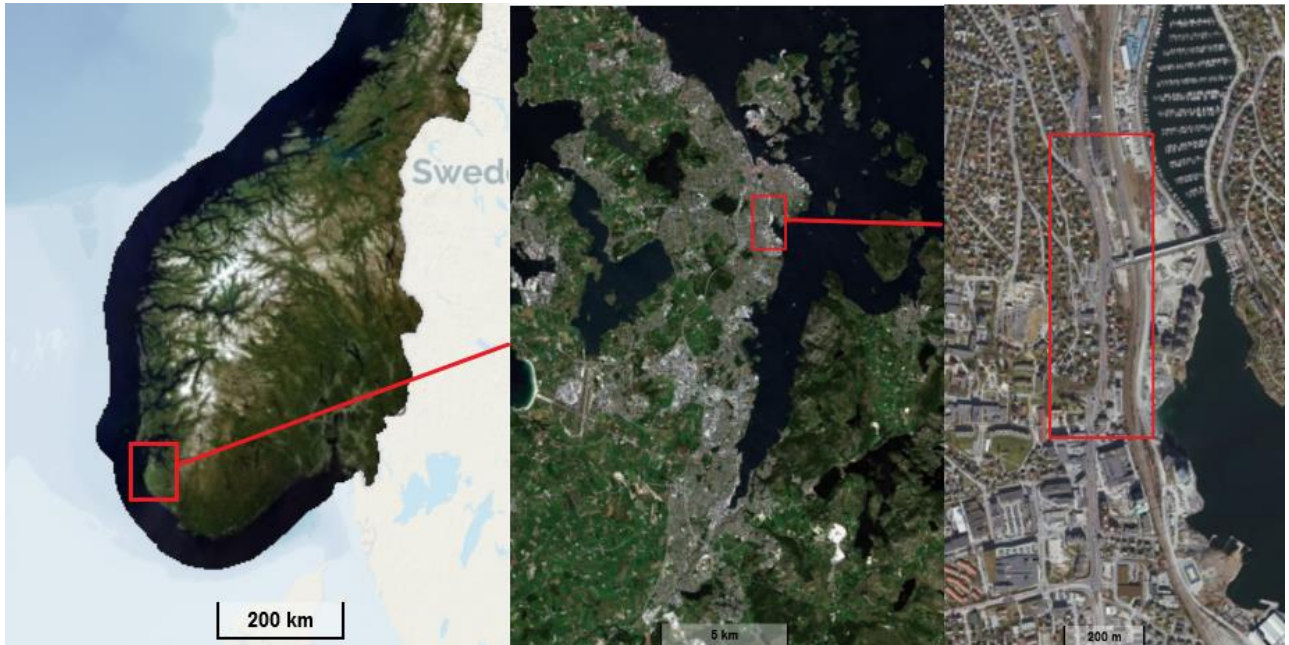

Figure 4 Location of the project area on map of south Norway and Stavanger area. North orientated. (Norgeskart, n.d.)

The project area consists of four roads, tunnel and bridge with five intersections as presented below:



Figure 5 Roads in the project area. North orientated. (Norgeskart, n.d.)

Main road going from south to north is Hillevågsveien (grey), then it makes a roundabout with Hillevågstunnelen (green) and Lagårdsveien (red). Further to the north, there are two exits with Skjærebergveien to the east (orange) and with Høylandsgata (yellow) to the west. For both roads vehicles are allowed to enter FV44 only turning right (presence of median strips).

Next is the roundabout with Strømsbrua (blue) and in the end roundabout with Musegata and access to Paradis train station (purple). Lagårdsveien and Hillevågsveien are part of County Road 44 (Fylkesveien 44) and for the purpose of the project name FV44 will be used for Lagårdsveien and FV44 sør for Hillevågsveien. FV44 is the main road where Bussveien will be implemented.

Another important fact about that part of that area is that it has one of the highest AADT (annual average daily traffic) in Stavanger as presented in the picture below.

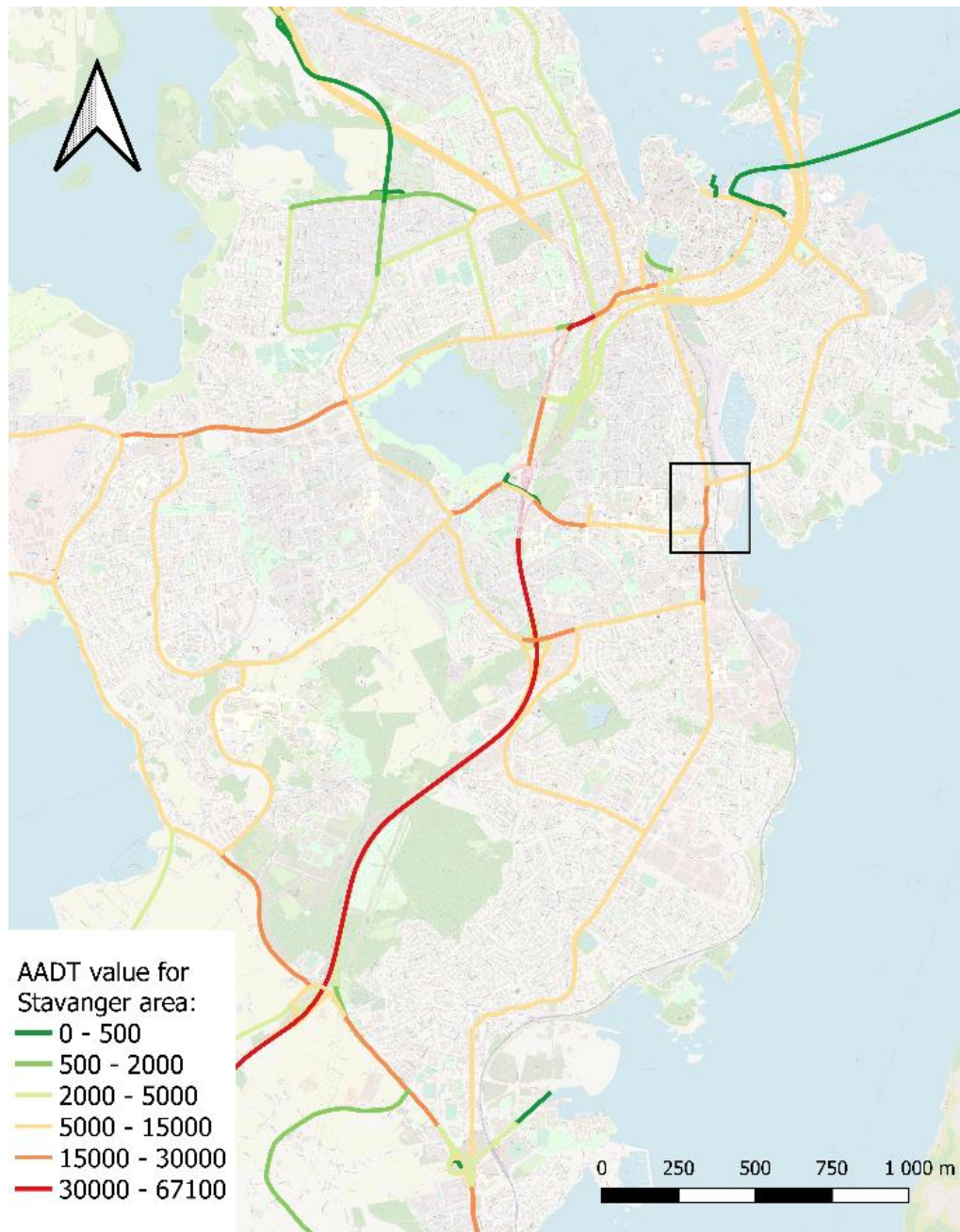

Figure 6 Graphic presentation of AADT value for Stavanger. Black square indicates project area. (authors)

This is due to merging traffic from the city center (coming from north) and Storhaug (coming from east from Strømsbrua) which split around 300m later to southern parts of Stavanger and to the west (where the motorway is located). The high AADT value also comes from the fact that in the project area there are plenty of bus lines going through. In the picture below - graphic presentation of bus routes.

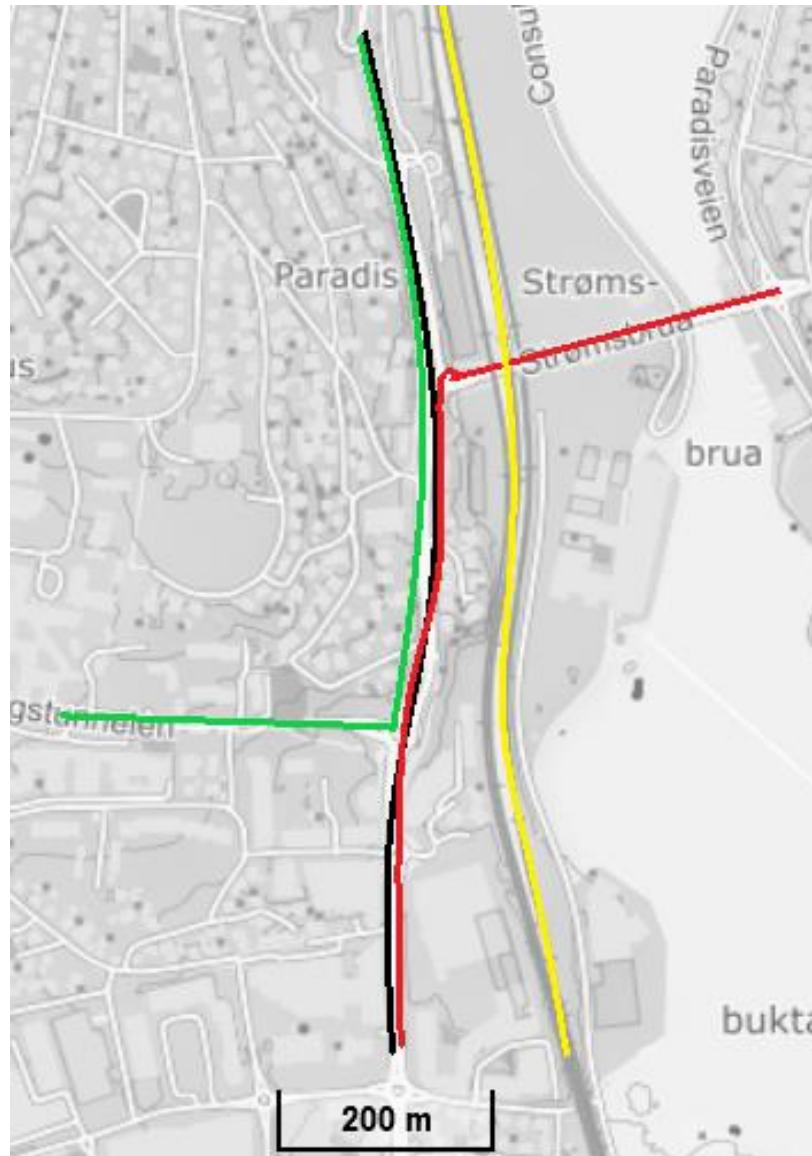

Figure 7 Bus routes and railway in the project area. North orientated. (Norgeskart, n.d.)

With the color black there are lines 2 and 3 which together in morning peak hour between 7 and 8 have around 16 rides. With green color are buses 4, X31, X39, X40, X50 and X60 with 19 rides in morning peak hour and with red color X74 with 3 departures in morning peak hours. With yellow color there is a railway presented. Data was checked for 17th April 2023 (Kolumbus, 2019).

1.4 Surroundings



Figure 8 Surroundings of project area (authors work)

The picture above shows the surroundings of the project area. As said, the project is located in close proximity to Stavanger city center. The roads lead to many different facilities around and thus high traffic is present. It was decided to divide places into 6 categories. First are educational places like schools and kindergartens (navy blue), with dark red is Paradis train station, which is important for the project since one of its objectives is to make a good connection between it and Bussveien. A wide group is 'others' where belong, among others, gyms, hairdressers and bike workshops (purple colour). There are also several restaurants (yellow) and shops (green). To the last group belong all different medical institutions like hospitals, clinics and doctors (red). Additionally, bus stops are marked with stars.

Most of the public places are located in the south of the project in Hillevåg district. Many shops, restaurants and some clinics cause heavy traffic in the area. To the west together

with the residential area, there is Stavanger Hospital - although it is planned to open a new hospital in a different part of Stavanger in 2024 and to sell old buildings to private investors, so the area will change its purpose (Stavanger Aftenblad, 2020). Both inside the project area and right to the north, there are some shops, restaurants and other facilities but in a much smaller amount than in Hillevåg. The area to the east is almost exclusively a residential one with just one school.

1.5 Problem statement and research questions

One of the most critical parts of every city is urban transportation. The bigger the city, the bigger the challenge to construct an efficient transportation network. With the steadily increasing urban population and the rapid expansion of urban areas, there is a growing demand for efficient, reliable, and sustainable transportation systems. According to The World Bank (2022) 56% of the world population lives in cities and by 2050 it is projected to be 70%. Express bus lines have emerged as a different alternative to other modes of transportation, offering unique advantages such as reduced travel times, increased accessibility, and better service reliability along with lower costs of construction compared to metro systems. However, the effectiveness of express bus lines in improving urban transportation is still an area that requires further investigation. In this context, this study aims to explore the impact of express bus lines on urban transportation, focusing on the potential benefits of new bus roads and their impact on walking time to bus stops, and the role of 3D modeling in road planning in the public sector.

RQ1: How do express bus lanes help in urban transportation?

This research question aims to explore the potential benefits and advantages of express bus lines in improving urban transportation. Some potential aspects to be investigated include reduced travel times, environmental impact, better service reliability, and reduced traffic congestion (Litman, 2023).

RQ2: How will the new bus road impact walking time to bus stops?

The research question focuses on the potential impact of the new bus road on the walking time to bus stops from adjacent areas. This will take into account the new sidewalk network and new location of bus stops to find out if the new proposal improves or deteriorates walking time.

RQ3: To what extent does utilization of Novapoint affect the planning process in public administration, and what is the level of accessibility for novice users?

The purpose of this research is to better understand how Novapoint is used in Rogaland County's public administration. In order to evaluate and validate the specialists' opinions, a 3D model for a particular section of the Bussveien between Hillevåg and Musegata will be reproduced in Novapoint. This particular segment was chosen because of its significance in the expansion of the local infrastructure.

The problem statement and research questions presented in this chapter will guide this project. The next chapters will provide a comprehensive review of the relevant literature, discuss the research methodology, present the findings including the 3D model and will end with conclusion.

2. Methodology

The main reasons why the author decided to write this project are the importance of Bussveien and author's internship at Rogaland County. The usage of Novapoint for the project is motivated by the fact that this program is widely used in Norway. Through this project, the author will gain fluency in working with this tool.

The author has a bachelor degree in civil engineering. The bachelor thesis regarded a problematic 5-way intersection and proposed a viable solution. The project presented in this thesis can be viewed as a continuation of author's goal to make cities' infrastructure safer and more efficient.

In order to answer research questions different methods, approaches and tools will be used. The first part of the project is a literature overview which aims to give insights to the theory of bus roads. Why such a solution is made and how it impacts users and surroundings. In international literature the most used name for bus roads is called Bus Rapid Transit (BRT). For the second part of the project, time analysis will be conducted for the existing and proposed location of bus stops. QGIS software will be used and as an outcome, areas for each time distance contour line will be presented and compared how Bussveien will impact the given area.

In order to answer the first part of RQ3: *To what extent does utilization of Novapoint affect the planning process in public administration (...)* four testimonies from road planners were gathered and analyzed. Then in order to evaluate and validate their answers, a 3D model of Bussveien is constructed for the section between Hillevåg and Musegata.

2.1 Walking time analysis

When it comes to walking time analysis, it was decided to use QGIS software since it is free to use and has a wide variety of free plugins which can make isochrone maps. Four plugins were analyzed for utility: Valhalla, TravelTime, ORS tools and QNEAT3. In the table below are presented features for these plugins.

Plugin:	Possibility to use own input layer	Different travel mode (walking, wheelchair, etc.)
Valhalla	No	Yes (cycling and walking)
TravelTime	No	Yes (cycling and walking)
ORS tools	No	Yes (4 types of cycling, 2 types of walking and wheelchair)
QNEAT3	yes	No (only possible to choose own speed)

Table 1 Choice of time analysis tool

Input layer is a layer of road and sidewalks network used by software to make analysis. Since for the purpose of the project, analysis will be conducted for *before* and *after* conditions, it was decided that only QNEAT3 can be used, even though it presents a poorer choice of travel modes. Moving speed was chosen as default 5 km/h since it is considered as normal walking speed. In the picture below - steps of constructing isochrones for walking time in QGIS.

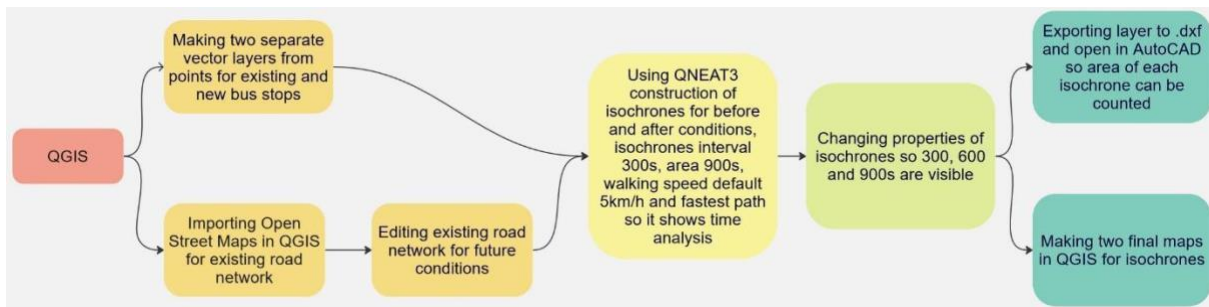

Figure 9 Process of construction isochrones in QGIS

2.2 3D modelling

Overview of the process of constructing 3D model is presented below (detailed process is in chapter 3).

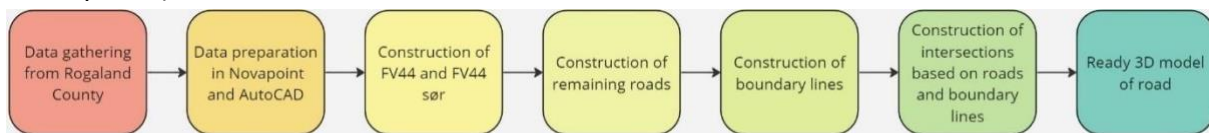

Figure 10 Process of construction 3D model in Novapoint

First step is to gather all needed data which includes dwg file of 2D proposal and SOSI files of the existing situation. These files were given by Rogaland County. SOSI files were downloaded by the County from website to which one needs special permission. After all data have been gathered, SOSI files are imported and converted to terrain model and separately to dwg drawing. Then 3D model is constructed first for main road and then for

secondary roads. Lastly, by using boundary lines, intersections are constructed, and model is done.

A limitation of the 3D model is the poor precision of some parts of centerlines. For FV44 between profile 148 and 188, the center line is not perfectly placed as presented in the picture below since it was lacking in 2D proposal and needed to be drawn manually. Nevertheless, offset is not significant and should not impact overall outcome. Additionally, boundary lines for road on both sides are placed correctly thus the road has proper width and is not offset by imperfection.

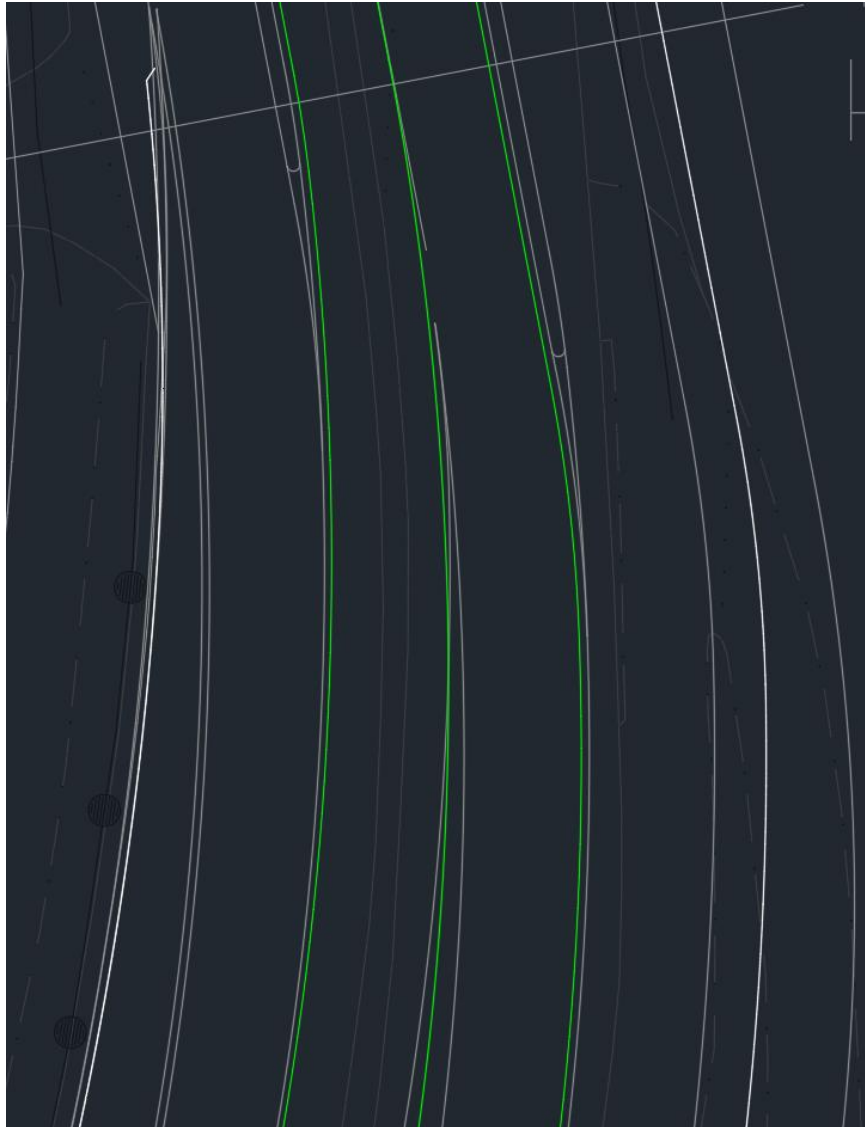

Figure 11 Not perfect location of center lines for FV44 with correct placement of boundary lines

3. Case Study – Bussveien in Stavanger

3.1. Principles of Bussveien

In this chapter principles of Bussveien design in Stavanger will be presented.

As mentioned in the introduction, bus lanes are located in the middle of the Bussveien and are physically separated by median strips from other vehicles, based on *Design guidelines for bus road* from Rogaland County (2018). This center location of bus lanes is connected to the second principle of Bussveien which is prioritizing buses on intersections. Prioritizing is done by signal controls – buses are equipped with GPS, and once the bus approaches an intersection – light turns red for all other vehicles entering the intersection. Such a system is already implemented in Stavanger (Seglem, 2011). Prioritizing will be implemented in two out of three intersections in the project area.

The first intersection, going from the south, is a roundabout with Hillevågstunnelen. This intersection will be the only one not prioritizing buses; bus lanes will merge with the rest of traffic as it is currently.

Next intersection is one with Strømsbrua. Rogaland County planned this one to be a signal controlled, bus prioritized T-intersection. Such solution will lead to periods where traffic jams will occur. In order to minimize impact on traffic, the County decided to remove a left turn in the direction from Stavanger center to Strømsbrua. Based on traffic counting done by the County, such solution will not impact many drivers (Rogaland Fylkeskommune, 2022, p.13).

The last intersection is the one with Musegata and exit to Paradis train station which will be constructed as a bus prioritized roundabout. Buses will drive through the middle of the intersection. Such a solution is already in use on Bussveien in Mariero (Rogaland Fylkeskommune, 2022, p.13). In the picture below - existing roundabout with bus prioritizing with visible traffic lights.



Figure 12 View on bus prioritized, signal-controlled roundabout in Mariero (authors picture)

The central location of bus lanes and thus keeping cyclists away from buses will increase safety of first ones. Currently, when approaching bus stops, buses drive into bike lanes, which are located along the road. In such a situation cyclists have two options: either to stop and wait for the bus, or to take over the bus from the left side which leads to riding in the middle of the street and can lead to traffic accidents. Additionally, incautious bus drivers may hit a cyclist when starting from the bus stop, especially due to the bus blind spot. Once separated bus roads are introduced, such problems will be solved. In the picture below - situation when a bus approaches the Strøsmbrua bus stop and drives on the bike lane.

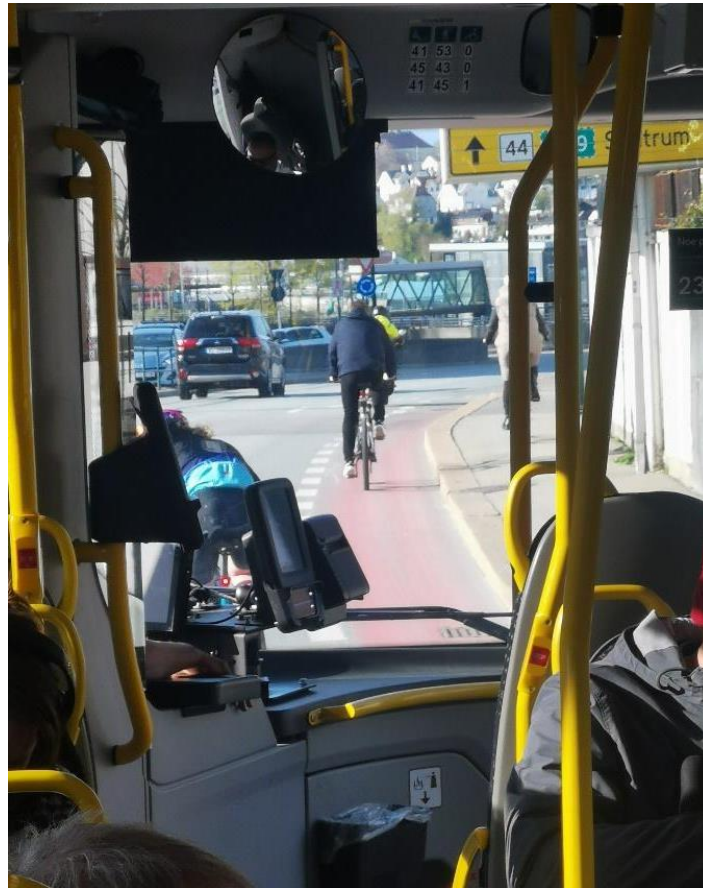

Figure 13 Situation when bus is driving on bike lane when approaching bus stop (authors picture)

As it is currently, bike lanes surfaces will be red and on the same level as the road. Red color intends to visualize division between driveway and bike lane. Another safety measure is the advance stop line (ASL), also called bike box. ASL is simply a designated area on a signal-controlled intersection where bikes can wait for green light. ASL are located in front of cars so they can be better visible for cars and trucks, and thus they prevent “right-hook” situations – when cyclists go straight, and car is turning right which can lead to accidents. In the picture below - bike box on the bus prioritized roundabout in Mariero.



Figure 14 Bike box on bus prioritized roundabout in Mariero (authors picture)

Construction of Bussveien also means changes for pedestrians – there will be more pedestrian crossings and fewer underpasses. Median strip will act also as a refuge island while crossing Bussveien. In chapter 4 Walking Time Analysis will be presented detailed changes concerning sidewalks network.

To sum up, Bussveien in the project area will have the same design principles as it has already in the section in Mariero, making a coherent whole, with the exception of intersection with Hillevågstunnelen. This will result in fast travel time for buses, and it will improve safety for pedestrians and cyclists.

3.2. Testimonials

In order to answer RQ3, testimonies were collected from four road planners in Rogaland County. They were asked a couple of questions like how long they have worked with Novapoint and how often, and how the use of Novapoint influences different aspects of their work on projects in scale from 1 to 5. Lastly, they were asked if they met any challenges or limitations while working with the software. Length of work experience with Novapoint varied between 2 and 5 years with an average of almost 4 years and all of them use Novapoint on a daily basis. Below are presented questions with answers.

Added value of Novapoint Respondents' perception of the added value of using Novapoint in public administration. Software's ability to improve the project...



Figure 15 Answers from road planners in Rogaland County concerning perception of the added value of Novapoint

Novapoint capabilities Specific capabilities of Novapoint that are relevant to public infrastructural investments. Ability to:

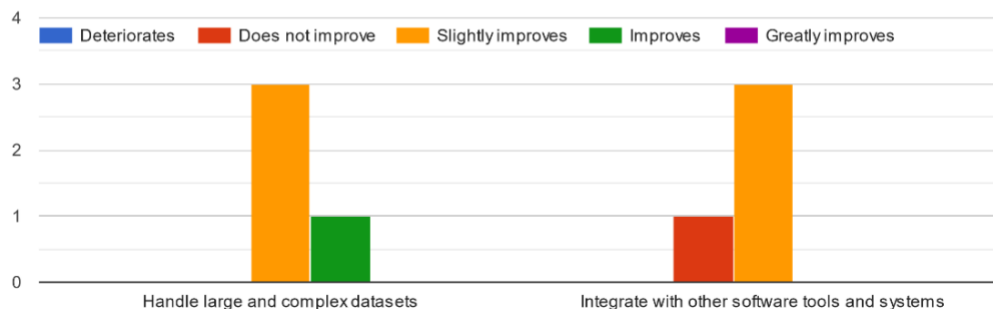

Figure 16 Answers from road planners concerning specific capabilities of Novapoint

As presented, the impact of Novapoint in all 7 categories is not big. Predominantly users agree that Novapoint just slightly improves their work on projects.

Last question about limitations and challenges provided answers which varied quite a lot - from minor problems and general satisfaction to opinion that Novapoint is ineffective,

unnecessary overcomplicated, not intuitive, it takes a long time to learn how to use it, it misses some functionalities and takes long time to update model if model is big.

Below original testimony, in Norwegian.

Det er et stort minus at man ikke kan bruke Novapoint på egen hånd, men at man må bruke det i samarbeid med AutoCAD for å kunne tegne ut veglinjer og modeller. Novapoint har også mye manglende funksjonalitet, ved at det er funksjoner i programmet som ikke fungerer slik det skal. Mye ved programmet er også unødvendig komplisert, og det er vanskelig å lage presise vegmodeller. Det er heller ikke intuitivt hvordan programmet skal brukes, og tar lang tid å lære seg. Novapoint håndterer også store filer veldig dårlig, så har man lange vegstrekkninger kan man måtte sitte og vente i mange minutter, noen ganger enda lenger, før det laster inn. Til sammen gjør det programmet ueffektivt.

This validation would help you formulate the policy decisions regarding the adoption of planning tools for use in administration.

3.3. Walking time analysis

As mentioned before, the main environmental goal for Norway is to become climate neutral. This means that not only huge investments and development of new technologies are needed but also changes in human behavior. Without the latter it will not be possible to transform society to a more sustainable one (Chapman, 2007). One part is to provide reliable public transport offers, and another is to ensure that walking distance is small enough for people to actually use public transport. By principle, walking distance of 400m to 800m, corresponding 5min to 10min walk, is considered maximal for people to walk, and not take a car (Statens Vegvesen, 2022, p.10; Guerra, Cervero, & Tischler, 2012).

Another aspect of how far people are willing to walk to the bus stop, is how long the overall journey is going to be. Study in Bielsko Biala, Poland presented *that there is a fairly strong dependency between the access time to the bus stop and travel time without the access time* (Soczówka, Kłos, Żochowska & Sobota, 2011, p.146). In other words, the longer the journey by bus, the longer people are willing to walk to the bus stop.

Proximity to bus stops not only increases ridership but also leads to better human health. Study from the USA presented that commuters using public transport spend on median 19 minutes per day for walking to and from transit and 29% achieved at least 30 minutes of physical activity only from that, which is a recommendation of daily activity time (Besser & Dannenberg, 2005). Another study presented that people using public transport moved between 5 and 10 minutes more than those using cars (Lachapelle et al., 2011). More physical activity due to walking to transit has a proven impact on BMI and obesity. Study measured those two metrics before and after construction of light railway transit in Charlotte, North Carolina, USA and found out reduction of BMI by -1.18 (proper BMI is between 18.5 and 24.9 (CDC, 2022)) and reduction of odds to become obese in a longer span by 81% (MacDonald et al., 2010). Similarly, another study done in Atlanta, Georgia, USA also found a correlation between walking and obesity - for every additional one kilometer walked, there is a reduction of likelihood of obesity by 4.8% (Frank, Andresen & Schmid, 2004).

Presented research shows the importance of walking for public health, even if it is just to access transit. However, it is also crucial that the access time is not too long. To find an optimal solution, walking time analysis was conducted for this project.

3.3.1 Sidewalks network

When comparing situations before and after, it was necessary to change not only the location of bus stops but also sidewalks network in QGIS. It was simply done using *Digitizing*

toolbar – Toggle editing – Add line feature so sidewalks were edited. In pictures below - network before and after.



Figure 17 Existing bus stops and road and sidewalks network



Figure 18 New location of bus stops and road and sidewalks network

As presented above, bus stops were reduced drastically, from 9 to 4, counting each in each direction. For sidewalks the network changes are as follows, from north to south.

- New pedestrians crossing in place where new bus stop is located
- New pedestrian crossings through FV44 (north to intersection) and Strømsbrua plus removal of whole underpass
- New pedestrian crossing next to Høylandsgata
- Underpass under roundabout to Hillevågstunnelen just in direction north south, no option to walk under FV44 from west to east side
- New pedestrian crossing where median strip acts as refuge island, between bus lane and car lane starts
- New pedestrian crossing in place where old bus stop Hillevåg is moved around 60m to north

There are two reasons why underpasses will be removed at the intersection with Strømsbrua, and zebra crossing will be implemented. First is limited space which occurs on that intersection - removal of the west part of the underpass will allow construction of road and bike lane in that space. The second is that it will curtail wild crossing of the main road. This problem is common in proximity to this intersection according to Hole, A. (2021). Her finding presents that people who crossroad, do that as a preferred way of crossing not because of rushing for buses but because usage of underpass extends walking distance drastically between two bus stops – 88m vs 210m. Additionally, going up and down while using the underpass is not preferred.

3.3.2 Walking time analysis – existing

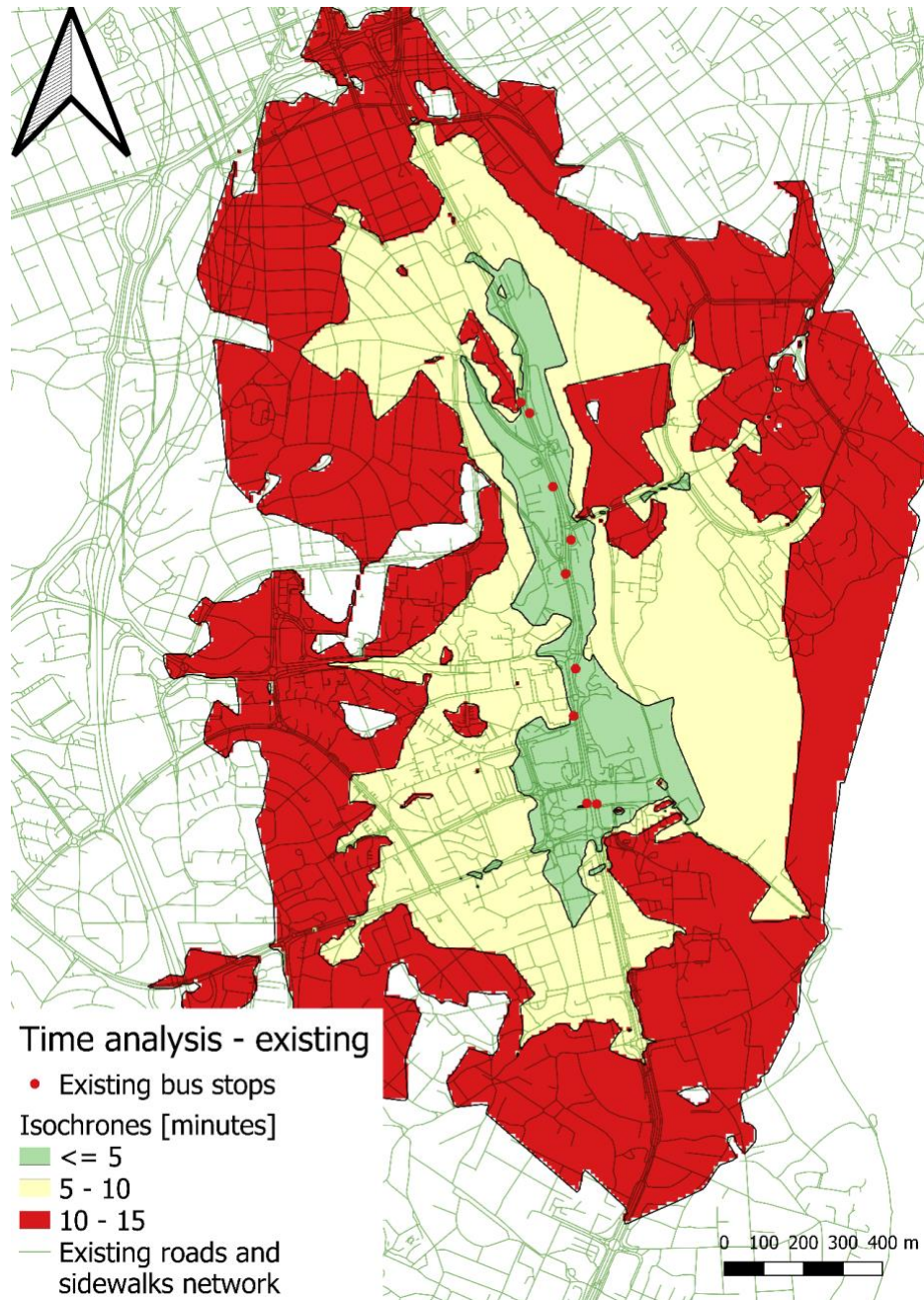

Figure 19 Walking time analysis for existing conditions (author's work)

Isochrone	Area [km ²]
5 min	0,30
10 min	1,20
15min	2,22

Table 2 Walking time analysis for existing conditions (author's work)

3.3.2 Walking time analysis - new

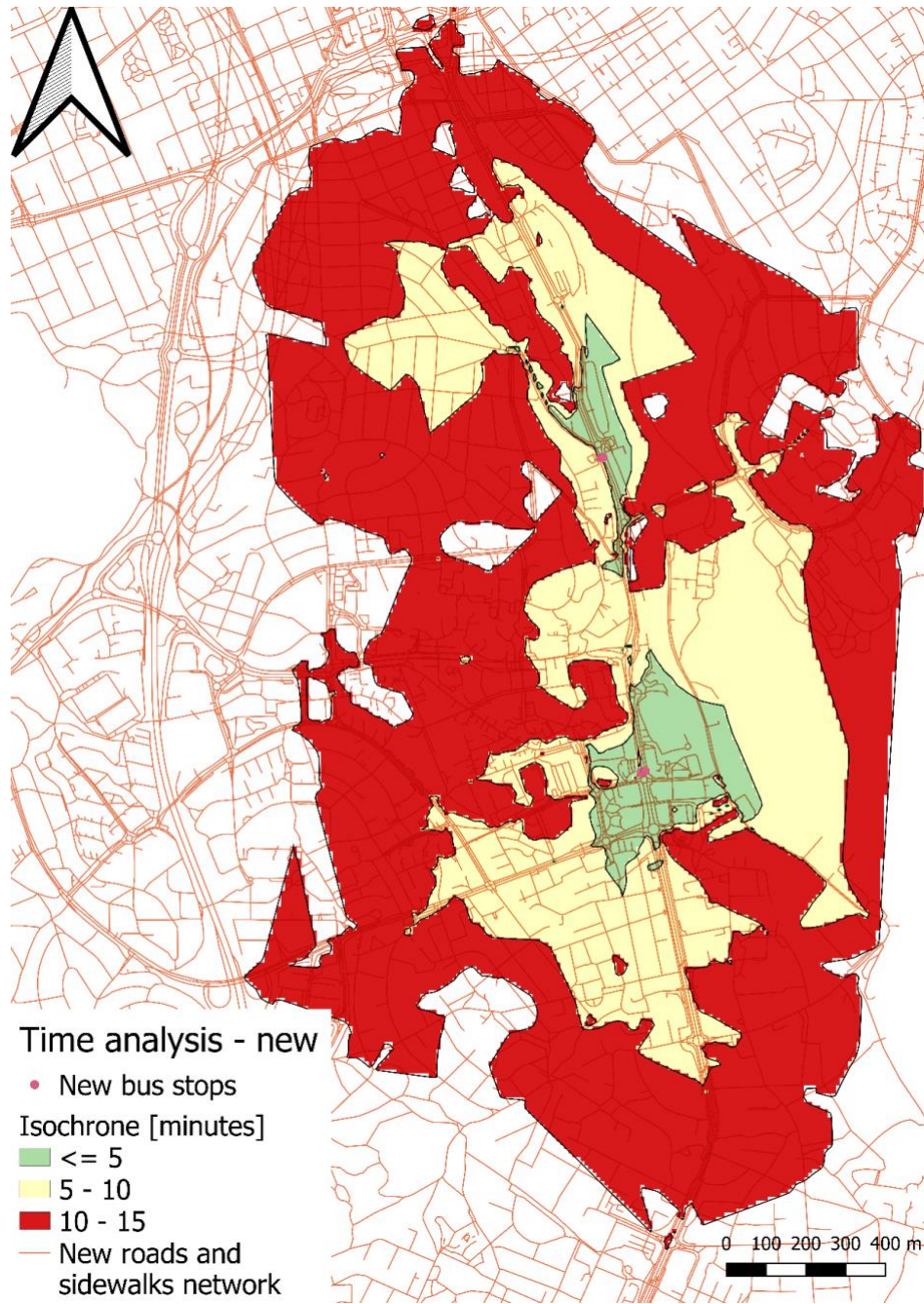

Figure 20 Walking time analysis for new conditions (author's work)

Isochrone	Area [km ²]
5 min	0,16
10 min	0,97
15min	2,21

Table 3 Area of each isochrone for existing conditions

3.3.3 Limitations

There are few limitations for this time analysis. One issue which is visible on figure 19 and figure 20 is the way software draws isochrones. There are visible islands of different isochrones which often make no sense. The best example is Strømsbrua - for existing and new conditions the isochrone is illogical, as it shows 15 min, even though the bridge is right next to bus stops in both existing and new conditions. This issue is hard to verify for the author since the only information about QNEAT3 is a code in Python which author is not familiar with.

The second issue is the poor choice of modes of transportation. Although it is possible to change moving speed, it is still hard to assume how a time analysis map would look like for people using mobility aids such as wheelchairs. So, the analysis is only done for people who walk and do so at an average speed of 5km/h.

3.3.4 Conclusion

As presented in the table below, when it comes to area covered by each isochrone, the biggest difference is for 5min isochrone - the new proposal cut the covered area by 45% but for 15min, the difference is just 1%. It is important to remember that urban density is not something which is distributed evenly (Bertaud, 2004). The number of houses which are in 5min covered area but are not anymore for new condition is rather small. It is suspected that there is smaller population density in the 5min covered area, but further research is needed.

Isochrone	Reduction in the size of covered area [%]
5 min	45
10 min	19
15min	1

Table 4 Difference of area of each isochrone (new vs old)

3.4 3D model

This chapter will focus on the construction of a 3D model in Novapoint.

During the next subchapters detailed process of construction will be presented, starting with an overview of Novapoint and AutoCAD, then preparation of files needed to work on through line and road task in Novapoint until the end which is a ready 3D model.

Principles of road model construction in Novapoint are presented in the picture below. First step - preparation of SOSI and dwg files are done only once at the beginning. The rest of the steps are replicated many times during the whole project. Construction of 3D model is done by editing manually different layers (*Vegflate*) depending on profile.

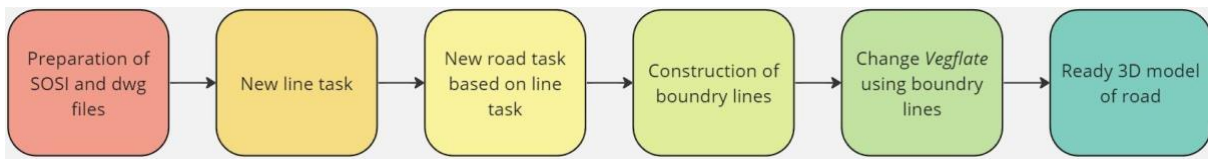

Figure 21 Overview of steps in Novapoint for 3D model construction

3.4.1. Overview of Novapoint and AutoCAD software

As mentioned before, Novapoint from Trimble together with AutoCAD will be used for construction of the 3D model. Novapoint is a Norwegian software bought by American Trimble. These two softwares are connected together (it is necessary to open AutoCAD from Novapoint) and each of them allows to do different parts of the project. AutoCAD is for drawing in 2D. Both horizontal and vertical alignments of center lines and boundary lines are drawn. Novapoint, on the other hand, converts 2D lines to 3D model and all other modifications of 3D model such as road layers, width and properties are done in Novapoint. In Novapoint two tasks will be used – *Linje* (line task) and *Veg* (road task) from *Veg og Jernbane* (road and railway) ribbon.

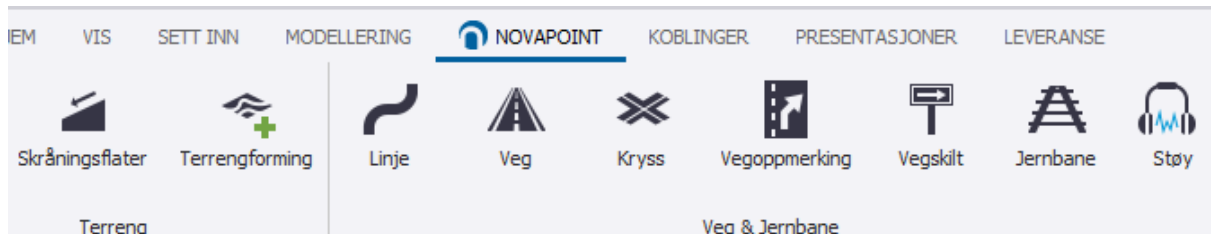

Figure 22 Tools used in Novapoint

Opening AutoCAD through Novapoint allows to see the plugin *Veg*, which is used to draw alignments later used in Novapoint.

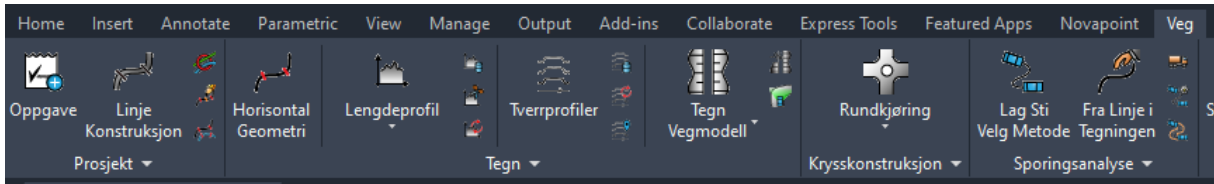

Figure 23 Tools used in AutoCAD

Most used tool is *Linje Konstruksjon*. It is for drawing horizontal and vertical alignments. Other tools used in the project are *Horizontal Geometri* to present ready horizontal geometry and *Lengdeprofil* for presenting vertical geometry.

3.4.2 Data Collection and Preparation

For data collection and preparation tutorial from Trimble was used (Trimble, 2019).

3.4.2.1 Data Collection

Data, which was received from Rogaland County, consists of two separate sets of files: SOSI files (which is Norwegian format) consist of 3D data of existing area which needed to be imported and converted to dwg in Novapoint. Dwg is AutoCAD format which is 2D and proposal of new Bussveien was provided in that format. 2D proposal does not have X, Y coordinates – it is plain drawing. Below are presented raw files.

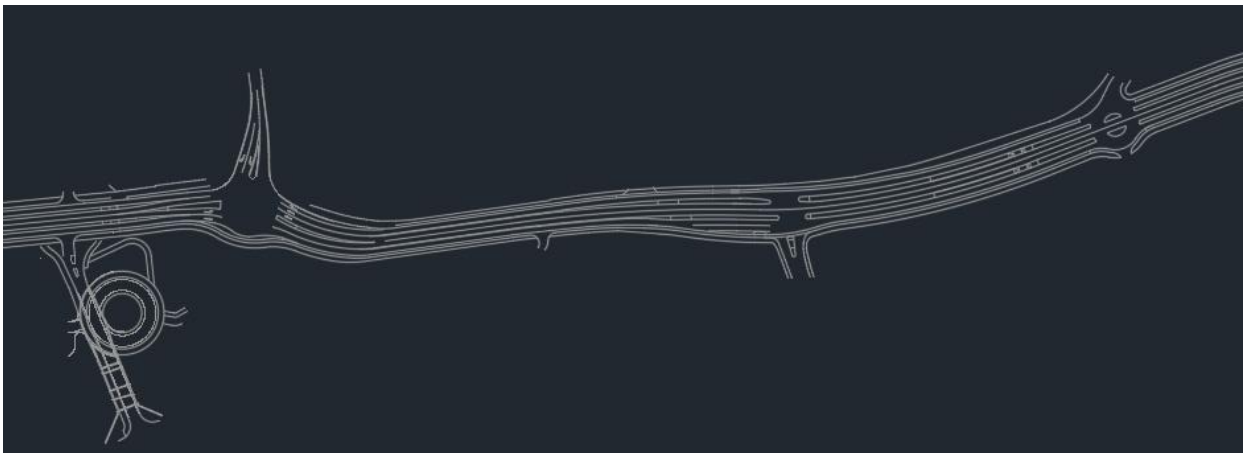

Figure 24 2D proposal in dwg from Rogaland County (west orientated)

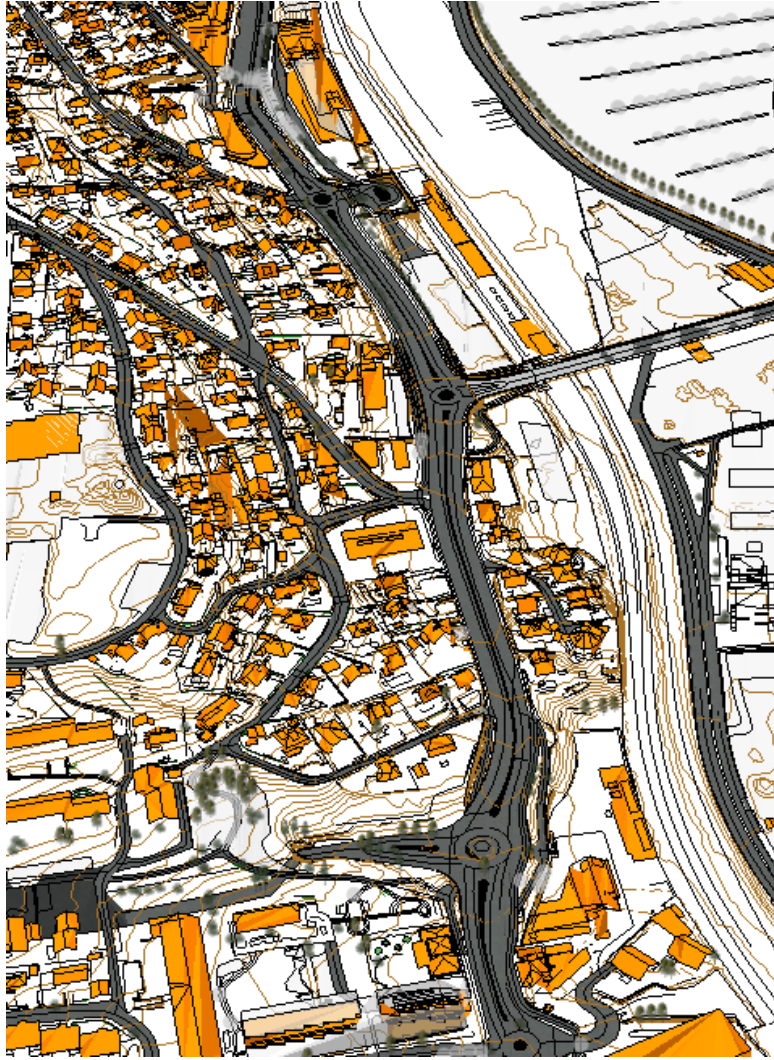

Figure 25 3D model for existing roads, roofs and contour lines made based on SOSI files (view from south)

3.4.2.2 Data Preparation

Once SOSI files are imported to Novapoint, terrain can be made - based on imported files of road, water and contour lines. Terrain is a crucial element since it allows drawing roads in proper latitude. The file representing terrain in this project is called *eksisterende terrenng SOSI* and is done as a triangulated area.



Figure 26 Eksisterende terreng SOSI

Another step is to construct buildings and Strømsbrua for final presentation.

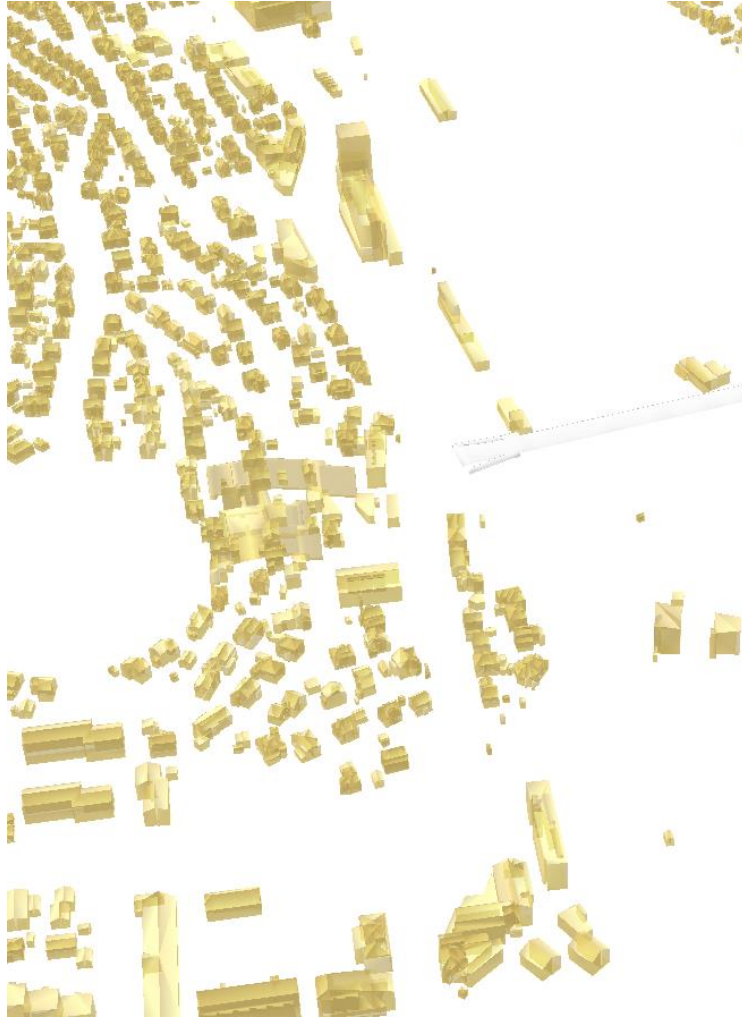

Figure 27 3D buildings with Strømsbrua

Next step is to make *Plan* in *Presentasjoner* of imported files so that a *dwg* file in *Leveranse* can be made and used in AutoCAD as presented below. Such file has X and Y coordinates, and different elements are placed in different layers so it is easy to work on that.

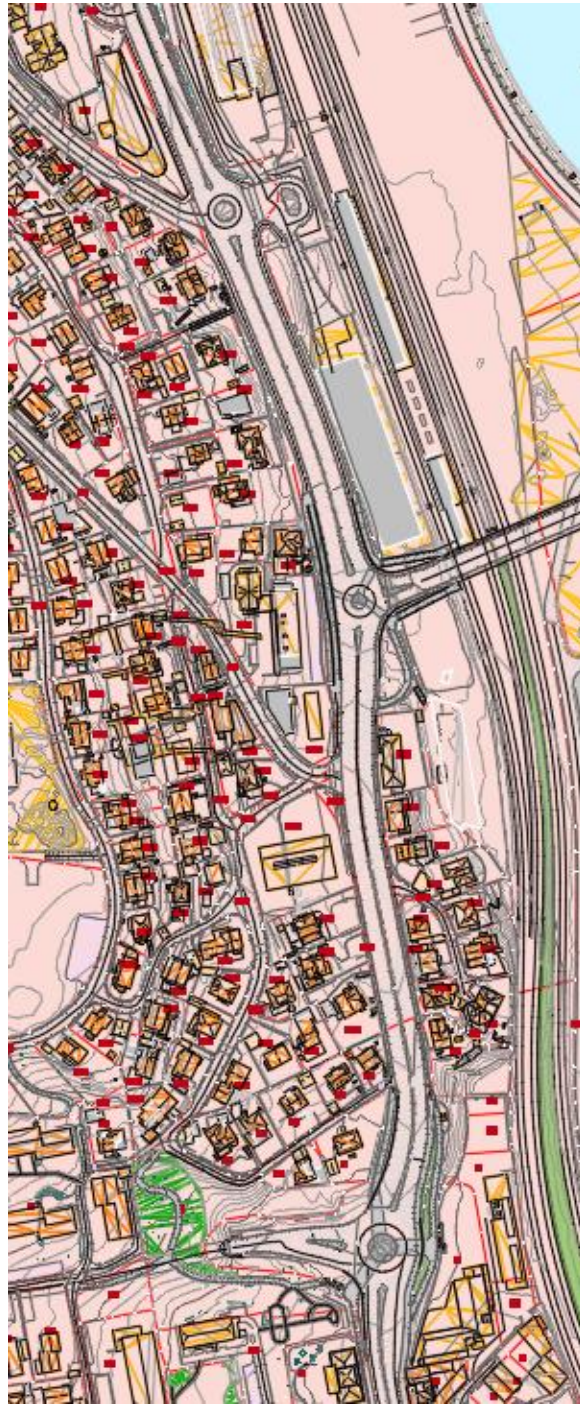

Figure 28 Prepared dwg file from SOSI

Next step was to clean the new dwg file by hiding most of the layers so in the end the only existing road network is visible. This allowed placing a dwg file of 2D proposal onto prepared file. To achieve as high accuracy as possible, the proposal file needs to be placed perfectly to existing conditions. This is done by moving the proposal onto the area, and then rotating it since the proposal file is not north orientated. Characteristic points which will not be changed, such as Strømsbrua and entrance to Hillevågstunnelen, are used for fitting. Final

file which is ready to work with is presented below (part in the south will not be taken care of since it is not directly part of FV44).

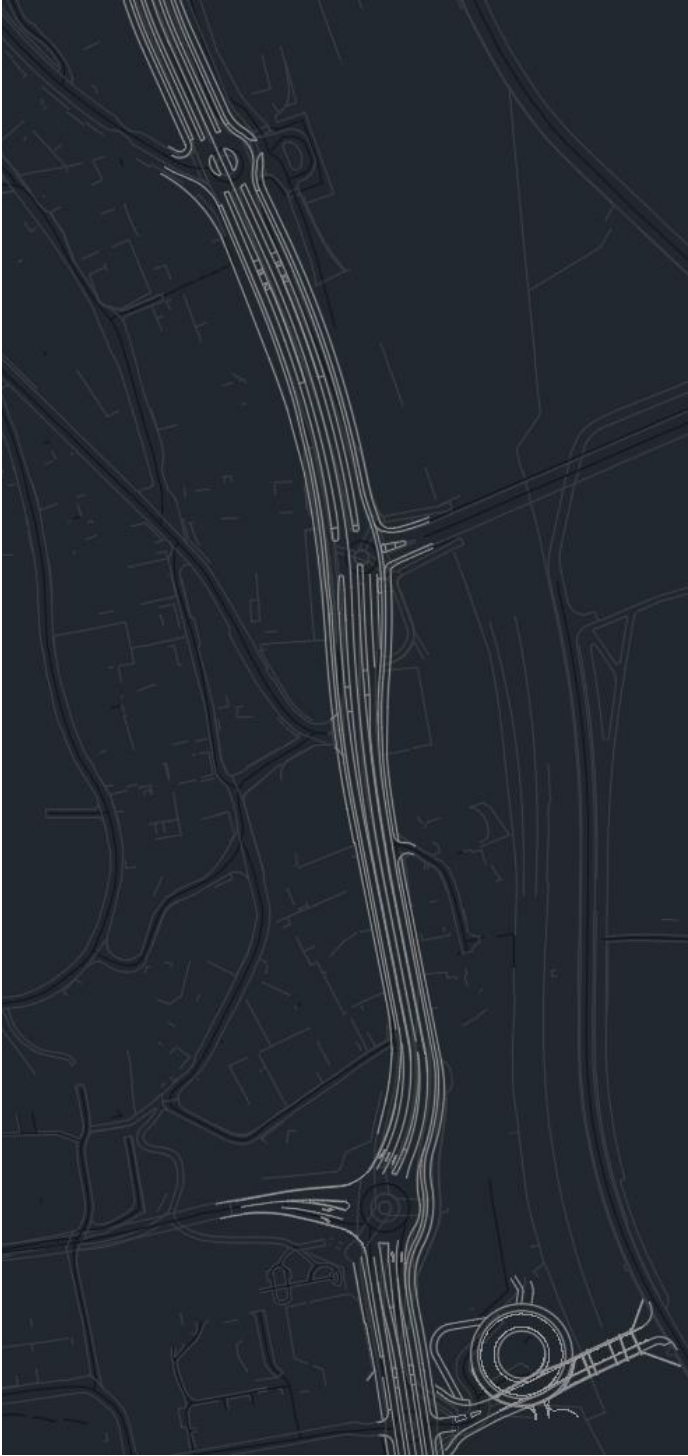

Figure 29 Ready to work dwg file with coordinates

As presented above, the proposal is missing centerlines for all secondary roads and parts of FV44 for the southern roundabout. These ones needed to be drawn manually and it can lead to some small inaccuracies.

3.4.3 Road Design

Once data is prepared, work on the 3D model can be started. The whole process consists of many steps starting from making *line task (linjeoppgave)*, so next step *road task (vegoppgave)* can be constructed which will result in 3D model. Then in order to achieve proper cross section, *layers (vegflate)* will be edited in accordance with Rogaland County design using newly constructed *boundary lines (avgrensninglinje)*. These lines delimited width and/or slope of each surface, resulting in proper shape of road tasks. In the end an appendix with input data for the 3D model together with horizontal and vertical alignments is constructed. Because author was working in Novapoint in Norwegian, some names are presented in that language with English translation.

In the end of this subchapter there is a table with the location of pictures of 3D model, horizontal and vertical alignment, road surfaces and input data in the appendix.

3.4.3.1 Line task

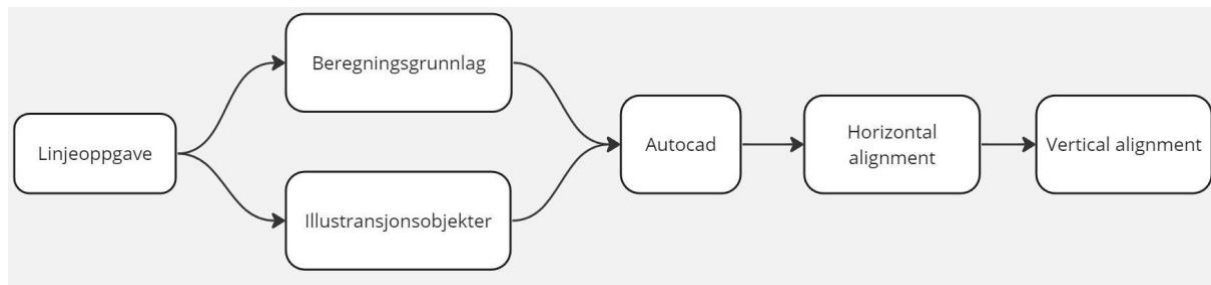

Figure 30 Diagram of steps for Line task

In the picture above are presented steps for construction of *line task*. When making a design of road the first step is to choose *Linje* in Novapoint, then in *Oppgave* (task) in *Velg beregningsgrunnlag* (choose basis for calculations) choose prepared before file *eksisterende terreng SOSI*. In that way existing terrain is used for making vertical geometry. Next step is to choose *Linje konstruksjon* (line construction) in AutoCAD and *Velg linje* (choose line). That option allows picking lines from the proposal as horizontal alignment of center lines without drawing them manually - with exception for secondary roads where they needed to be drawn manually. When picking lines, frequent error messages were encountered.

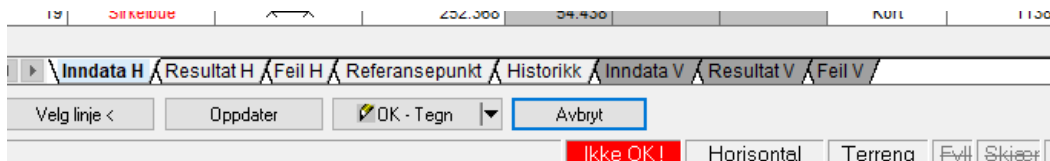

Figure 31 Error message "Ikke OK!" while picking line in horizontal alignment.

This problem was usually because two lines cannot be connected to each others without a curve between, another problem was that two lines were overlapping. In that way it was

needed to manually delete lines and insert curves or merge few lines in one. This problem happened to some boundary lines, for example boundary line for left sidewalk. Even though Novapoint allows to create 3D model with *Ikke OK!* (Not OK!) error, it might cause other problems in future like reducing accuracy or not complying with design standards. Therefore, changes like removing some straight lines or adding new curves were done manually.

Once horizontal alignment is ready, vertical one can be constructed. Since new roads will be in same location as existing ones, it is crucial to follow the elevation of existing terrain as close as possible. In that way the costs of construction will be reduced and access to estates will be ensured. Also for road of max speed 40km/h which is the case, vertical radius must be no smaller than 150m (N100, 2022, p.18).

3.4.3.2 Road task

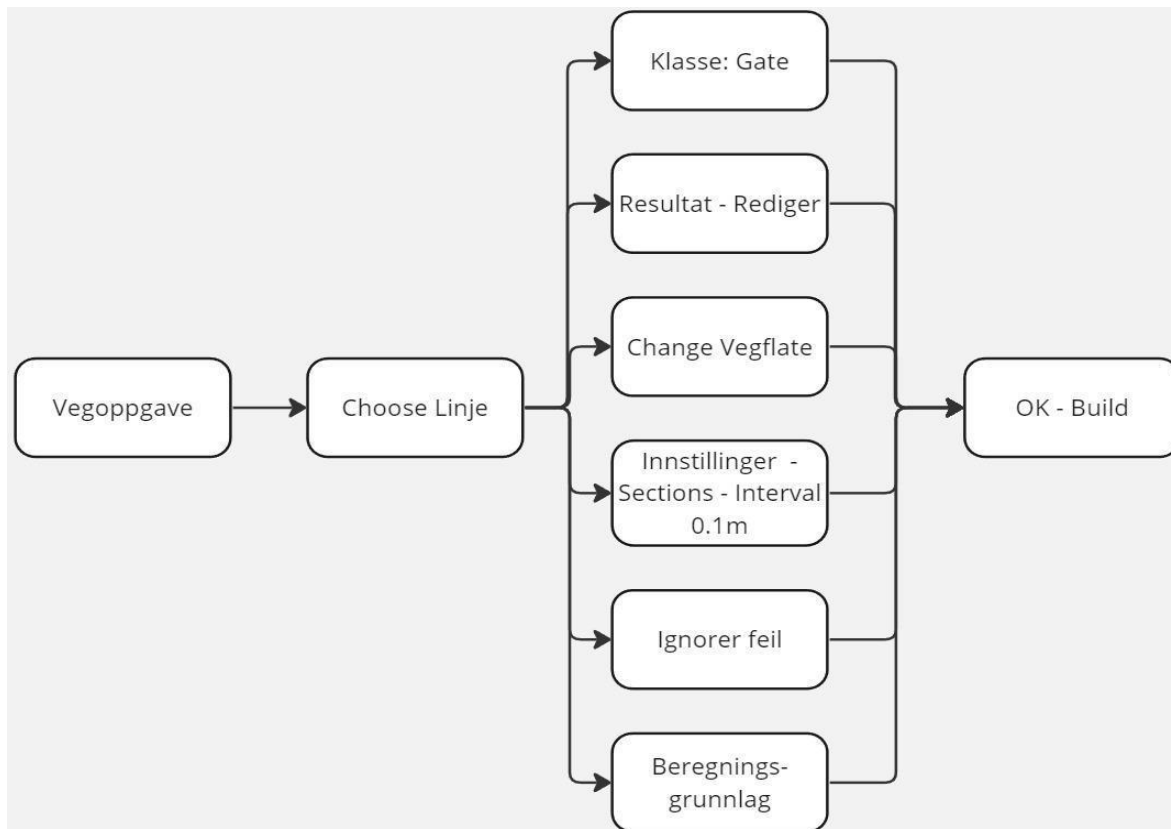

Figure 32 Diagram for steps of Vegoppgave

When horizontal and vertical alignments are done for each line task, construction of road task can be done as presented in the figure above. In Novapoint the new *Veg* (road) is made and in *Oppgave* (task) it is chosen which line task should the road follow. In *Veg Normal* it is chosen *Norway (2018)* and in *klasse – Gate*. Road norm allows to choose a set of

predefined roads and class - for different classes of road different layers under the road surface will be used.

Since all roads are located in the city *Gate* is chosen. In *Basis for calculations* same terrain file as for line task is chosen. Another thing is to change the interval to much smaller (0.1m in the project) – in that way, curvatures for small radiuses are well presented. This is especially important for median strips and traffic islands. Lastly, *Ignorer feil* is chosen to allow construction of model even when some errors occur. Most often error is when surfaces of the same road task cross each other, for example in traffic islands and median strips. Novapoint shows errors but does not help to locate them precisely nor offer to solve them automatically. Below is presented an automatically built road using *Klasse: Gate*.

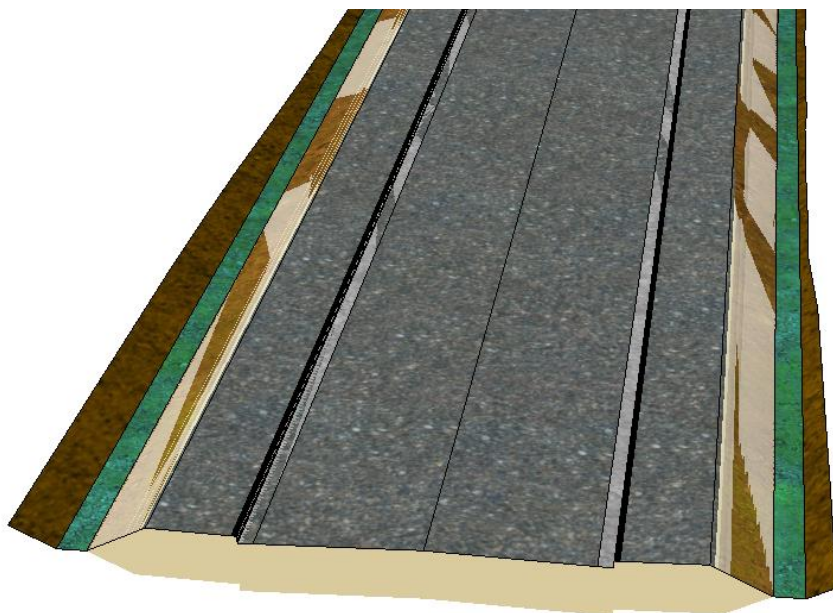

Figure 33 Predefined road gate based on CL-FV44

As presented, such a road is just a base for changes in order to get preferred design. On Figure 1 in the introduction presents the desired cross section of Bussveien.

Next step is to add new *Vegoverflater* (road surfaces) in *Vegflate* (road surface) so the cross section of road is as desired. Road surfaces are different lanes of road such as bus lanes, bike lanes or curbstones. They are divided to the left (*venstre*) and right (*høyre*) sides, looking in the direction of the centerline. Additionally, on top there is window *Avgrensninger* (boundaries) which allows to delimit road by line task or surface. Every road in the project is delimited at least by sidewalk so there are no surfaces from *grøft to fylling*. Reason is that these last surfaces are not needed for construction in the city and leaving them results in a mess when they cross each other between different road tasks. Depending on the road, delimitations will be done using other surfaces. Using surface *Primærlinje*

means to boundary side by center line and thus, the whole side is not existing. Most of the work on the model is done by editing road surfaces. The first step is to add manually surfaces so in the end it looks like the figure below for FV44 /sør.



Figure 34 Surfaces for FV44/sør

Surfaces 2.08, 2.09 and from 3.02 to 3.08 are added. Adding these surfaces can be done in two ways or as presented on figure above where all new surfaces are added in section *Skulder* (shoulder) and *Tilleggsflater* (additional surfaces) or can be also added in *Kjørebane* (Roadway). Names are inserted manually. Overall, it does not change the outcome, and is used just for having order in the project.

3.4.3.2.1 Surface properties

Change of surfaces results that in default they do not have properties as wanted – in 3D model they present different material than desired. So, the next step, only for FV44 and FV44 sør, is to change surfaces properties using *Resultat – Rediger – Konverteringsregler – Resultat-objekt* as presented below.

Konverteringsregler							
Ny regel Sett inn regel Slett regel Slett alle reglene Kontrollør for duplikater				<input type="checkbox"/> Omorganisere ↑ Flytt opp ↓ Flytt ned		Generer regler fra forhåndsvisst modell Generer regler fra .txt-fil	
Regler				Sortering		Opprett regler	
Aktiv	O	Kildens objekt	Kildens egenskap	Kildens sub-egenskap	Verdi	Resultat-objekt	
<input checked="" type="checkbox"/>	<input type="checkbox"/>	LegacySurface	leagyTaggedValueList	VIPSSURFACENO	-3.02	Kjørefelt	
<input checked="" type="checkbox"/>	<input type="checkbox"/>	LegacySurface	leagyTaggedValueList	VIPSSURFACENO	-3.03	Vegskulder	
<input checked="" type="checkbox"/>	<input type="checkbox"/>	LegacySurface	leagyTaggedValueList	VIPSSURFACENO	-3.04	Kjørefelt	
<input checked="" type="checkbox"/>	<input type="checkbox"/>	LegacySurface	leagyTaggedValueList	VIPSSURFACENO	-3.05	Vegskulder	
<input checked="" type="checkbox"/>	<input type="checkbox"/>	LegacySurface	leagyTaggedValueList	VIPSSURVACENO	-3.06	Kjørefelt	
<input checked="" type="checkbox"/>	<input type="checkbox"/>	LegacySurface	leagyTaggedValueList	VIPSSURFACENO	-3.07	Vegskulder	
<input checked="" type="checkbox"/>	<input type="checkbox"/>	LegacySurface	leagyTaggedValueList	VIPSSURFACENO	-3.08	Sykkelfelt	
<input checked="" type="checkbox"/>	<input type="checkbox"/>	LegacySurface	leagyTaggedValueList	VIPSSURFACENO	-3.09	Kantsteinskant	
<input checked="" type="checkbox"/>	<input type="checkbox"/>	LegacySurface	leagyTaggedValueList	VIPSSURFACENO	-3.10	Kantsteinskant	
<input checked="" type="checkbox"/>	<input type="checkbox"/>	LegacySurface	leagyTaggedValueList	VIPSSURFACENO	-3.11	Vegskulder	
<input checked="" type="checkbox"/>	<input type="checkbox"/>	LegacySurface	leagyTaggedValueList	VIPSSURFACENO	-3.12	Vegskulder	
<input checked="" type="checkbox"/>	<input type="checkbox"/>	LegacySurface	leagyTaggedValueList	VIPSSURFACENO	-3.13	GangSykkelveg	
<input checked="" type="checkbox"/>	<input type="checkbox"/>	LegacySurface	leagyTaggedValueList	VIPSSURFACENO	-3.14	Sykkelfelt	
<input checked="" type="checkbox"/>	<input type="checkbox"/>	LegacySurface	leagyTaggedValueList	VIPSSURFACENO	-3.15	Kantsteinskant	
<input checked="" type="checkbox"/>	<input type="checkbox"/>	LegacySurface	leagyTaggedValueList	VIPSSURFACENO	-3.16	Kantsteinskant	
<input checked="" type="checkbox"/>	<input type="checkbox"/>	LegacySurface	leagyTaggedValueList	VIPSSURFACENO	-3.17	Gangveg	
<input checked="" type="checkbox"/>	<input type="checkbox"/>	LegacySurface	leagyTaggedValueList	VIPSSURFACENO	-3.18	Vegskulder	
<input checked="" type="checkbox"/>	<input type="checkbox"/>	LegacySurface	leagyTaggedValueList	VIPSSURFACENO	-3.19	Vegskulder	
<input checked="" type="checkbox"/>	<input type="checkbox"/>	LegacySurface	leagyTaggedValueList	VIPSSURFACENO	-3.20	Kantsteinskant	
<input checked="" type="checkbox"/>	<input type="checkbox"/>	LegacySurface	leagyTaggedValueList	VIPSSURFACENO	-3.21	Kantsteinskant	

Figure 35 Change of surface properties in Konverteringsregler for FV44/sør

Result objekter are changed so it corresponds with surface name e.g., bike lane is Sykkelfelt.



Figure 36 Different types of graphic presentation of 3D model in Novapoint

Next step is to change graphic presentation as presented on figure above. By default, Novapoint presents model as *Sketch* (not as default although the name). In *Sketch* all layers look like asphalt, but when switched to *Default* one can see that different layers look different. Below part of FV44 and roundabout in north, where surfaces which should be same material are different.

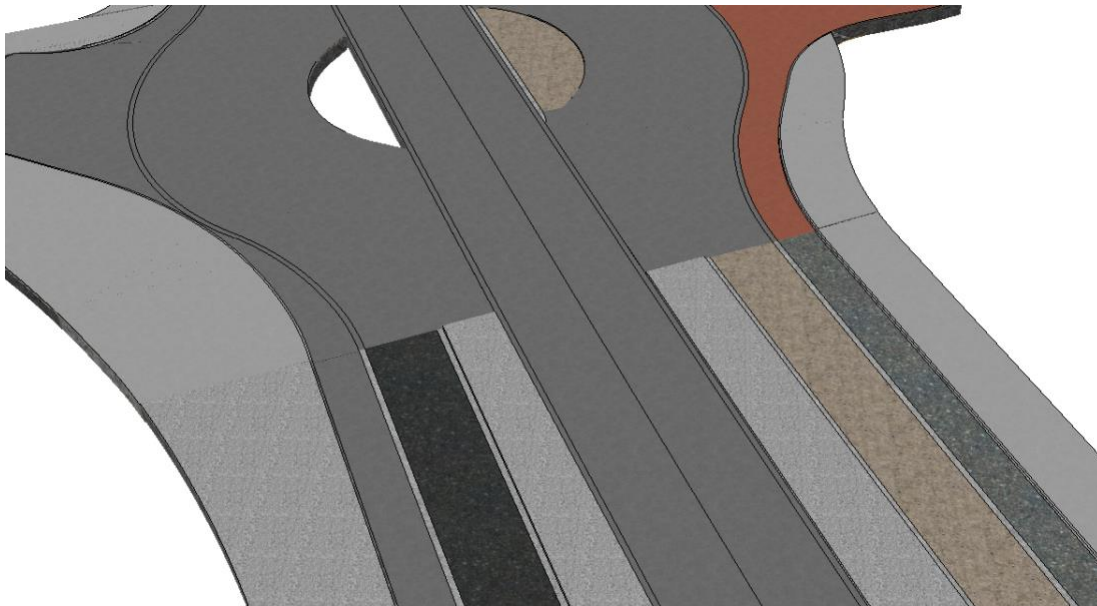

Figure 37 FV44 and north roundabout, in Default colors

For example, Bussveien should have bike lanes in red color but somehow only part for roundabout north is red, and only lanes for buses look like asphalt. Below are properties for bike lane for roundabout (left) and FV44 (right).

Egenskaper		Egenskaper	
Sykkelfelt		Sykkelfelt	
Identifikasjon		Identifikasjon	
Navn	Rund. nor. h. kjørefelt 1.15 H.Sykkel...	Navn	FV44 3.06 H.Sykkelfelt
proposedOrExisting	Planlagt [1]	proposedOrExisting	Planlagt [1]
Classification		Classification	
Oppgave		Oppgave	FV11
Gyldig tidsperiode		Gyldig tidsperiode	
Gyldig fra	05.05.2023	Gyldig fra	21.04.2023
Gyldig til		Gyldig til	
Spesifikk		Spesifikk	
generalMaterialTypes	Asfalt [1]	generalMaterialTypes	I_Aspfalt07
teksturnavn	T_Aspfalt07	teksturnavn	I_Aspfalt07
metadata	ROAD	metadata	ROAD
liableDiscipline	ROAD	liableDiscipline	ROAD
Geometri		Geometri	
område	1 Triangulering	område	1 Triangulering
Diverse		Diverse	
LoadClassificationA...	False	LoadClassificationA...	False
Utbredelse		Utbredelse	
Langs lenke	1 utbredelser	Langs lenke	1 utbredelser

Figure 38 Surface properties for bike lane, roundabout north (left) and FV44 (right)

As visible, there is only one difference (marked in red), which cannot be added to FV44 which could solve that problem. Because of that issue, all screenshots of the model are presented in *Sketch*, to not confuse reader which different colors of surfaces. As found later, the new version of Novapoint 2023 allows to change materials correctly. This was not possible to do since only Novapoint 2022 was available for the author.

3.4.3.2.2 Cross section and boundary lines

Until now, the cross section of Bussveien has default width so the next step is to fill surfaces with data – how wide they need to be in which profile. Since the road is in a city where space is limited and so lines change width depending on profile, it is needed to construct *avgrensning linje* (boundary lines) which will indicate where which surface should end up (in terms of cross section). Boundary lines are simply line tasks and they have crucial role in 3D model – when used, surfaces follow them. They are used in *road surface* by choosing *Ny linje* (new line) and then in window *Linje som flateavgrensning* (line as surface boundary). Then there are three things which need to be chosen: for which profiles of road boundary line is used, which line is used and which method. Methods are presented in the figure below. During this project only methods 0 and 1 were used. Method 0 is to only boundary surface by line without changing its slope. For this method only horizontal geometry of boundary line is used, such method was used for boundary of lanes for e.g.,

FV44/sør. Method 1 uses both geometries, this method is used for construction of intersections - it changed elevation of sides of roads so different roads meet at the same point in three dimensions.

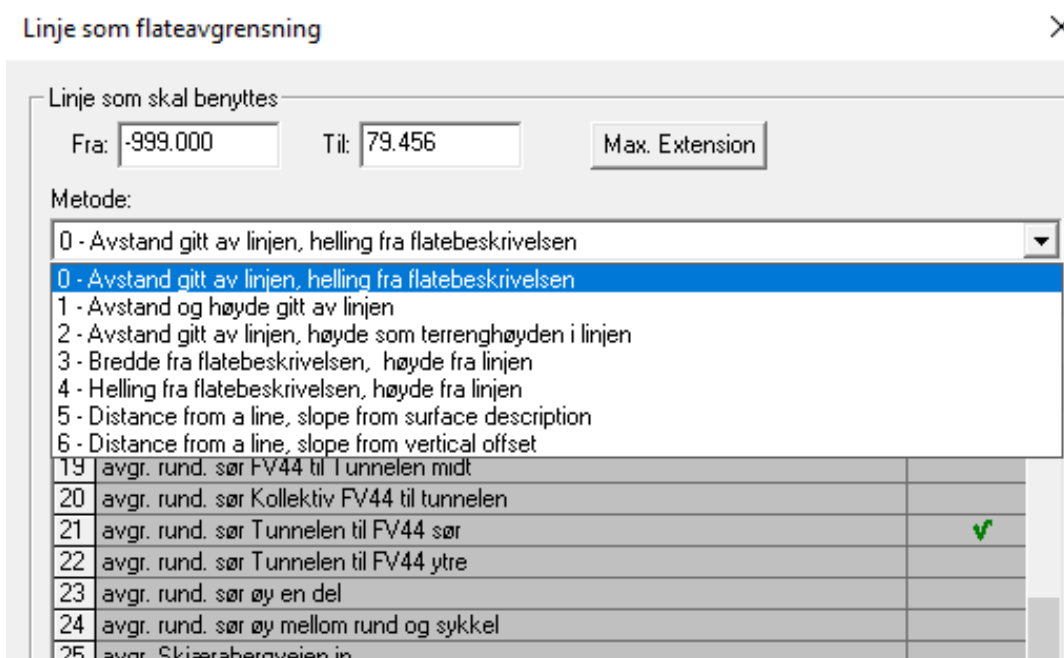

Figure 39 Window Line as surface boundary, showing how boundary lines are implemented in 3D model

Horizontal alignments for boundary lines of FV44/sør were drawn based on 2D proposal, each line for each surface. Since lines will be used with method 0, no vertical geometry was drawn.

Below full list of all boundary lines for FV44:

- ↷ avgr. fortau høyre
- ↷ avgr. fortau venstre a
- ↷ avgr. fortau venstre b
- ↷ avgr. høyre kjørebane skulder
- ↷ avgr. høyre kollektiv skulder
- ↷ avgr. kjørebane høyre 2a
- ↷ avgr. kjørebane høyre 2b
- ↷ avgr. kjørebane venstre 2a
- ↷ avgr. kjørebane venstre 2b
- ↷ avgr. sykkel høyre
- ↷ avgr. sykkel venstre a
- ↷ avgr. sykkel venstre b
- ↷ avgr. venstre kjørebane skulder
- ↷ avgr. venstre kollektiv skulder

Figure 40 List of all boundary lines for FV44

During the project often lines will have in names - h. for høyre and v. for venstre. Right is in the west and left on the east since the project is north orientated.

Below location of boundary lines for FV44/sør on cross section (profile 00 for FV44sør).

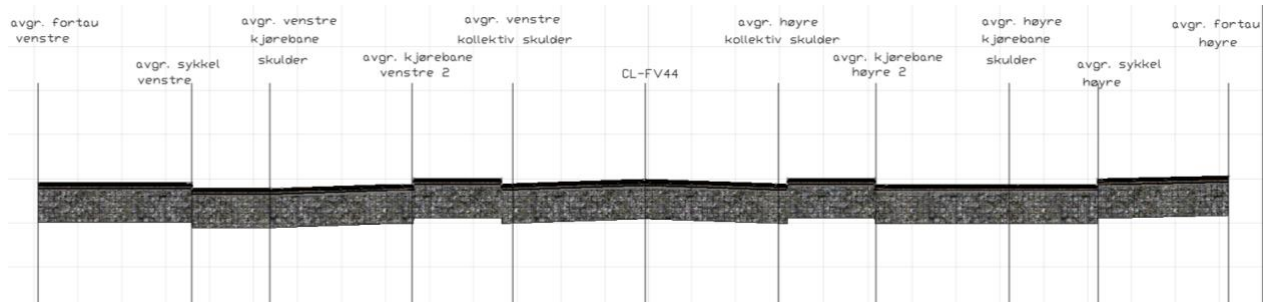

Figure 41 Location of boundary lines on cross section of FV44 sør, profile 00

Avgr. Kjørebane høyre/venstre 2 are delimitating median strips.

There is no need to make boundary lines for every surface since shoulders always have 0.25m width. Once FV44/sør has desired shaped, the next step is to construct intersections. Below are presented all steps from starting a new project until construction of intersections.

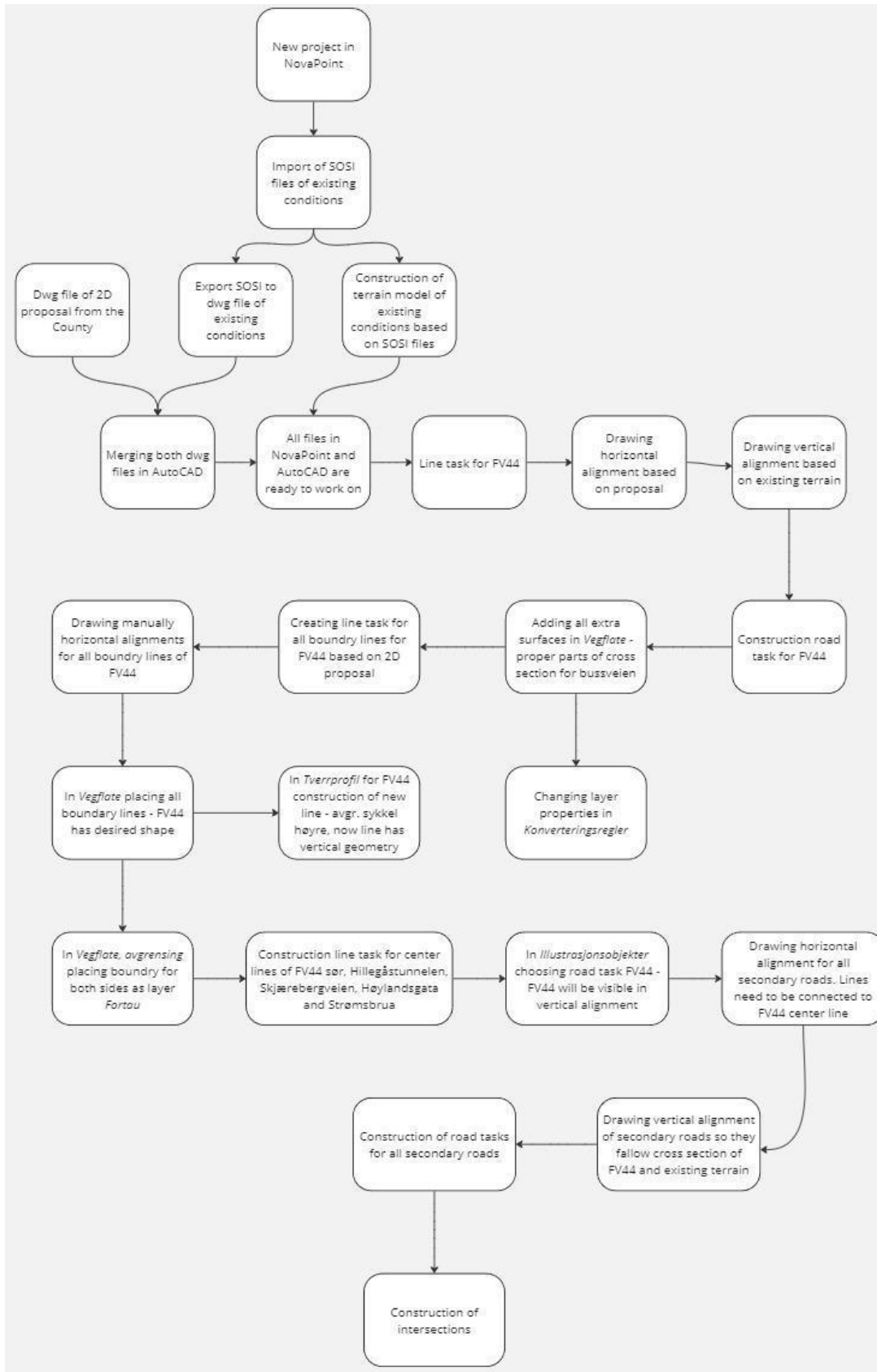

Figure 42 All steps for road construction starting from new project until construction of intersections

Which road:	What:	Which page(s) in appendix:
FV44 sør	3D model	11
	Horizontal alignment	13
	Vertical alignment	14
	List of surfaces	15
	Input data for surfaces	16
FV44	3D model	41
	Horizontal alignment	45
	Vertical alignment	47
	List of surfaces	49
	Input data for surfaces	50

Table 5 Where to find what in appendix for FV44 and FV44 sør

3.4.4 Intersection Design

As a main source of information for construction of intersection in Novapoint, was used official YouTube channel of *Novapoint & Quadri*.

In the end of each subchapter there is a table with location - in appendix - of picture of 3D model, horizontal and vertical alignment, road surfaces and input data.

3.4.4.1 Design principles and standards for intersections

For design of intersection handbook V121 Geometrisk utforming av veg- og gatekryss and N100 Veg-og gateutforming from Statens Vegvesen were used.

The principle of intersections design is to have horizontal alignment of secondary road connected to center line of FV44. In *Illusrasjonsobjekter* (background picture) for line task, to choose Bussveien, in a way that when drawing vertical alignment, cross section of FV44/sør is visible, and alignment is following cross section of the main road. Also, vertical alignment needs to finish in the same level as existing conditions. Then road task is done for secondary roads.

3.4.4.2 Signal regulated T – intersection

The only T-intersection in the project area is the intersection between FV44 and Strømsbrua.

Once the road task is constructed for Strømsbrua, the next step is to make two boundary lines – avgr. Strømsbrua in for traffic coming from FV44 to the bridge and avgr. Strømsbrua ut – for traffic in the opposite direction. Horizontal alignment follows 2D proposal and is connected to avgr. Sykkel høyre. For background picture, FV44 and Strømsbrua are chosen. Then vertical alignment is drawn so there is proper connection between those two roads – the beginning is at the same level as FV44 and the end as Strømsbrua. Then these lines are used in *road surface* for surfaces *Kjørefelt* (lane) using method 1.

During the project additional line avgr. FV44 T kryss h. was constructed. It follows avgr. Sykkel høyre and length is only for distance between avgr. Strømsbrua in and ut. It was unnecessary but also it does not provide any negative value to the project, so it was kept. Line avgr. FV44 T kryss h. is used only FV44 and not Strømsbrua.

In the picture below three boundary lines and center line of Strømsbrua are presented.



Figure 43 Location of boundary lines for T – intersection

Once boundary lines are used, Strømsbrua presents as following:

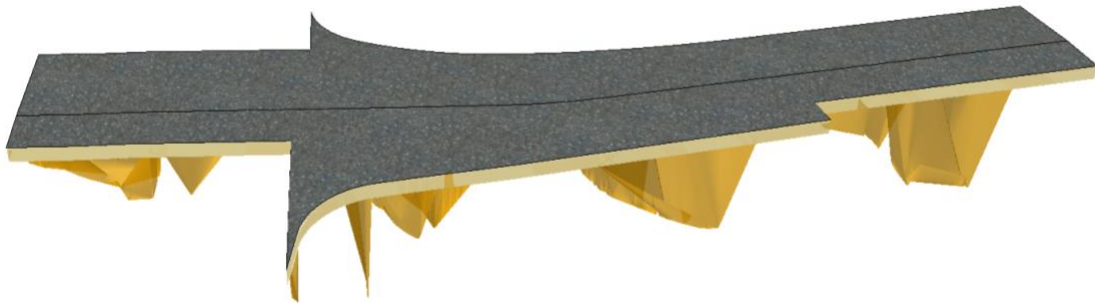

Figure 44 Strømsbrua 3d model after use of avgr. Strømsbrua in and ut

Next step is to delimitate the beginning and the end of the road so there is as little as possible of overlapping layers. Delimitation is done by using center line for distance from CL-FV44 to profile where avgr. Strømsbrua in/ut start. That way Strømsbrua looks like that:

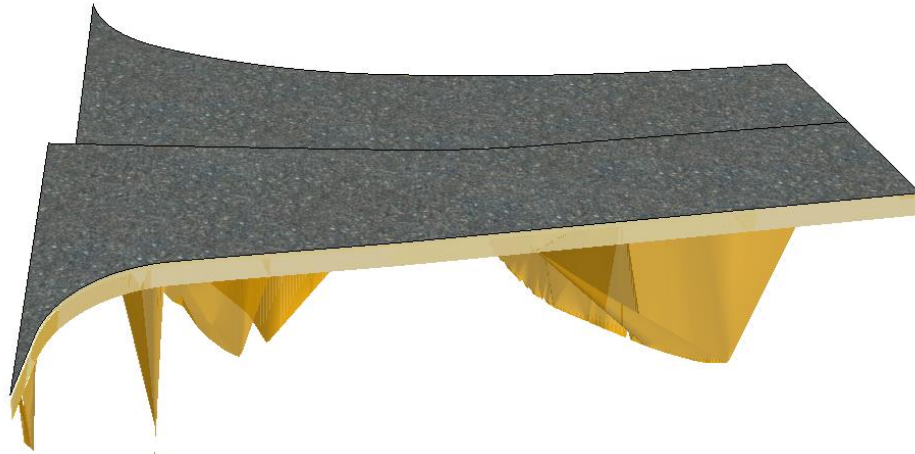

Figure 45 Strømsbrua with proper shape and beginning and end

Next step is to construct shoulders, curbstones and sidewalks for both sides of the bridge. To achieve that new road tasks are constructed based on previous boundary lines – Strømsbrua in fortau and Strømsbrua ut fortau. Side to the bridge is delimited by the center line, the outer side is delimited by sidewalk and sidewalks boundaries are done using new two boundary lines - avgr. Strømsbrua in/ut fortau. Below is presented Strømsbrua with both sidewalks.

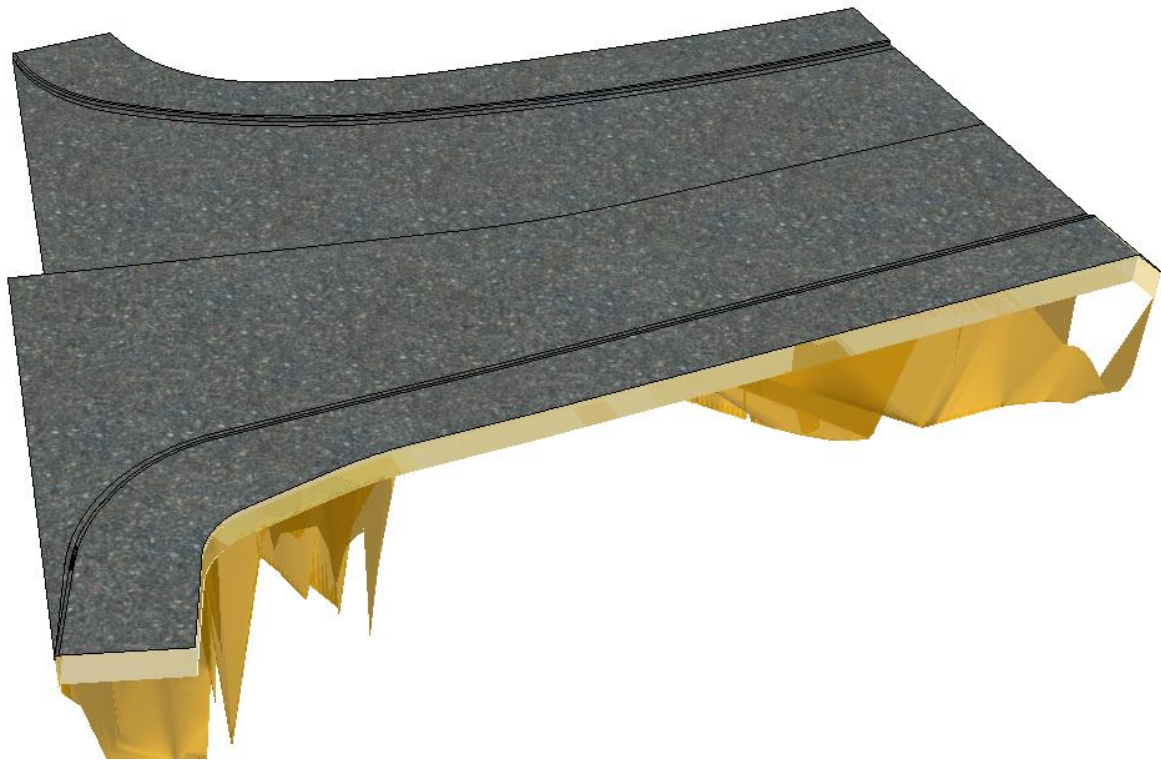

Figure 46 3D model of Strømsbrua with sidewalks

The next step is to cut out curbstones and sidewalk for the part of FV44 where Strømsbrua is connected, using boundary line avgr. FV44 T kryss h. so there is little of overlapping layers.

Little and not none since it was not possible to cut Strømsbrua nicely to curvature of FV44, so there are small parts overlapping. Also, for part of FV44 median strips are deleted, so instead of having median strips in the middle of intersection, surfaces remain the same but elevation is the same as for lanes (see picture below).

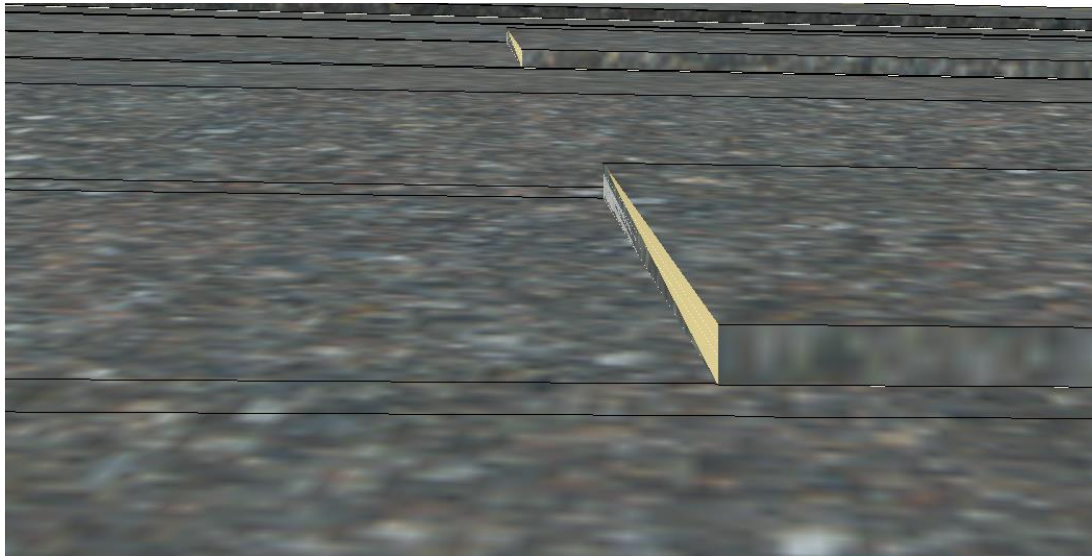

Figure 47 On the left side there is cut median strip, so it has same level as lane and on the right side – uncut median strip

The last step is to construct secondary islands and rounding of median strips on FV44 where median strips were cut. Detailed steps of making islands and median strips see chapter 3.4.4.6.

Overall, four rounding of median strips were constructed together with traffic island on FV44 as presented below, and traffic island on Strømsbrua – Strømsbrua trafikkøya.

- ☰ T kryss midtdeler
- ↷ Midtdel T kryss h. nord
- ↷ Midtdel T kryss h. sør
- ↷ Midtdel T kryss v. nord
- ↷ Midtdel T kryss v. sør
- ↷ T kryss trafikkøya

Figure 48 Lines for rounding of median strips and traffic island for T – intersection, location on FV44

The whole intersection with median strips and traffic islands is presented below.

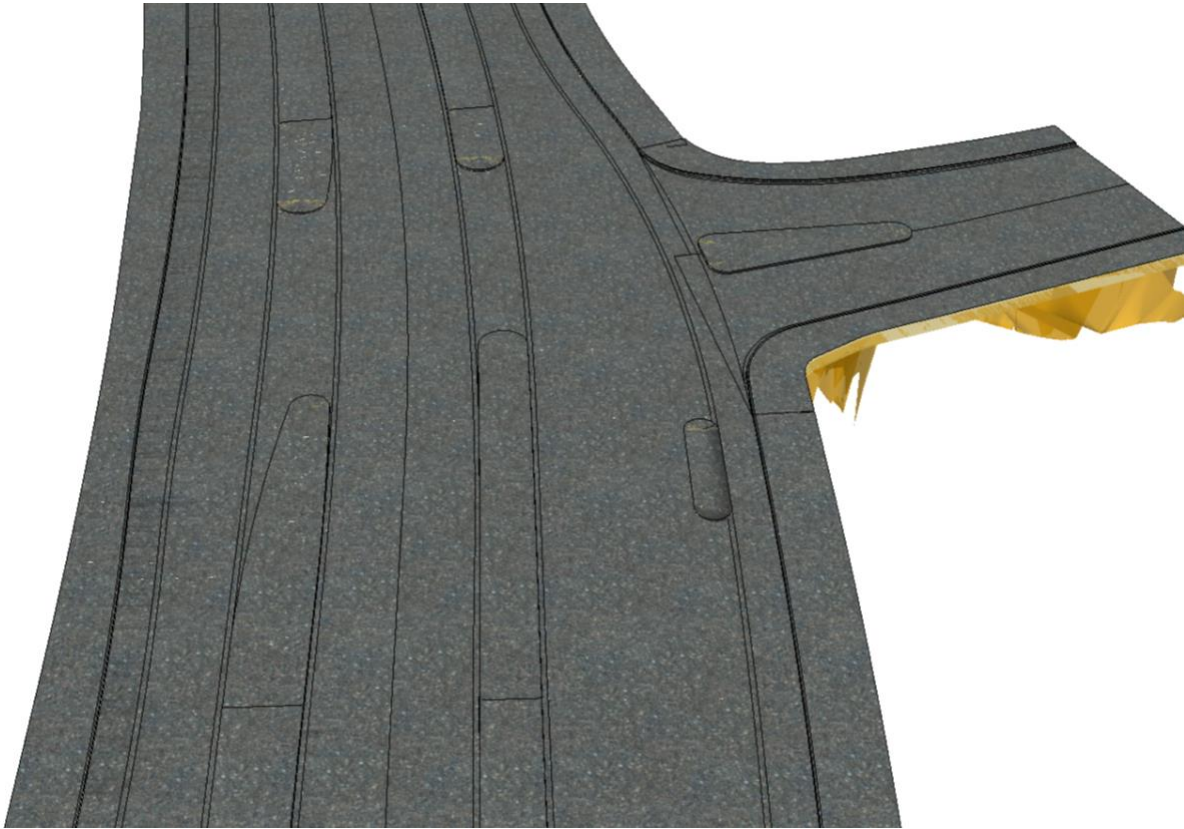

Figure 49 3D model of T-intersection (view from south)



Figure 50 3D model of T-intersection (view from top)

Below are all steps of construction of that intersection.

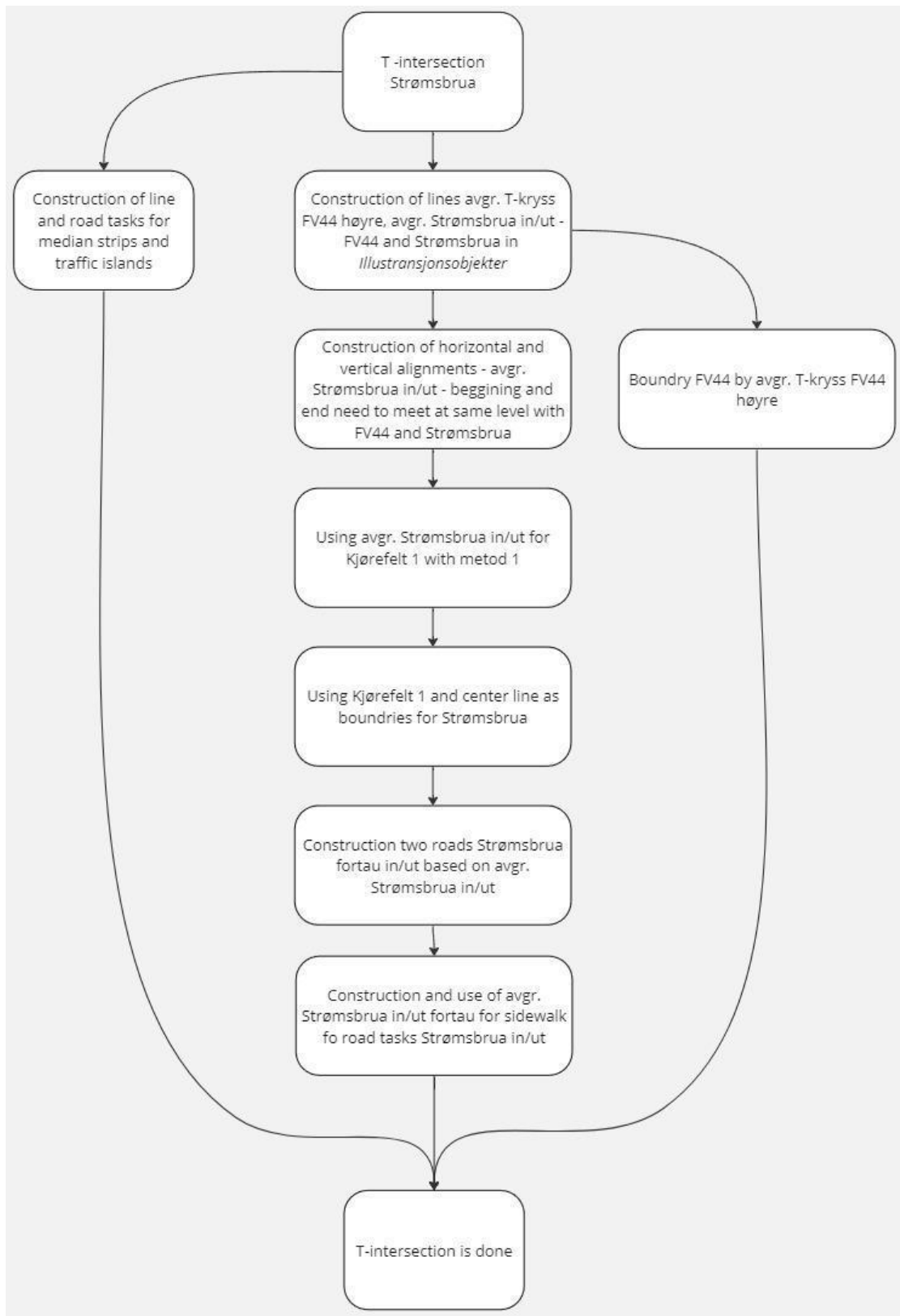

Figure 51 All steps of construction T-intersection

Which road:	What:	Which page(s) in appendix:
Strømsbrua	3D model	55
	Horizontal alignment	56
	Vertical alignment	57
	List of surfaces	58
	Input data for surfaces	58
Strømsbrua in fortau	3D model	59
	Horizontal alignment	60
	Vertical alignment	61
	List of surfaces	62
	Input data for surfaces	62
Strømsbrua ut fortau	3D model	63
	Horizontal alignment	64
	Vertical alignment	65
	List of surfaces	66
	Input data for surfaces	66
Strømsbrua trafikkøya	3D model	67
	Horizontal alignment	68
	Vertical alignment	69
	List of surfaces	70
	Input data for surfaces	70

Table 6 Where to find what in appendix for T-intersection

3.4.4.3 Exit to Høylandsgata and Skjærebergveien

The next step is the construction of exits to Høylandsgata and Skjærebergveien.

Statens Vegvesen defines exit (avkjørsel) as *drivable connection to a road or street network for a property or a limited number of properties (Med avkjørsler menes (...) kjørbar tilknytning til veg eller gatenett for en eiendom eller et begrenset antall eiendommer* (Håndbok V121, 2014, p.52).

The difference between exit and intersection is ÅDT value. As long as ÅDT ≤ 50 (or less than 10 housing) for incoming road and ÅDT ≤ 2000 for main road (FV44 has much higher ÅDT) connection can be constructed as an exit, otherwise it must be constructed as a normal intersection. For Skjærebergveien the situation is simple – alongside the road there are 7 houses. For Høylandsgata the situation is more complicated since the road is longer and

does not have a dead end. Nevertheless, there is no space for construction of a full intersection in give space, therefore the connection is constructed as an exit.

Exit to Høylandsgata and Skjærebergveien are very similar to each other, that is why they will be discussed together. General principles for construction are nearly the same as construction of previously discussed T-intersection. The main difference is that instead of cutting part of FV44 where the bridge is connected, curbstone and sidewalk are lowered to two cm. Lowering is half meter long (distance of declining /inclining curbstone is 0.5m) and highest part of curbstone starts/finishes where boundary lines for exits meet with FV44. It is worth noting that the exit should be constructed as a single radius 4m (V121, 2014, p.52) which was not done in the 2D proposal. For Skjærebergveien radius = 5m and for exit to Høylandsgata - constructed of two radiuses 4m and 16m. For the latter, it is because of the long curvature of the secondary road. The reason for Skjærebergveien using 5m radius is unknown but was followed.

Boundary lines used for Høylandsgata are Høylandsgata in and ut and for Skjærebergveien – Skjærebergveien in and ut. For Skjærebergveien, the exit consists of only roadway without either curbstone nor sidewalk. It is due to its current geometry – the road has 3.8m width which is very narrow, and traffic is extremely low. Additionally, there is a secondary island in Høylandsgata in the same place as it is now – Høylandsgata øya. For both exits, since there is a median strip on FV44, there is a must to turn right to primary road. Below are presented 3D models of those two roads:

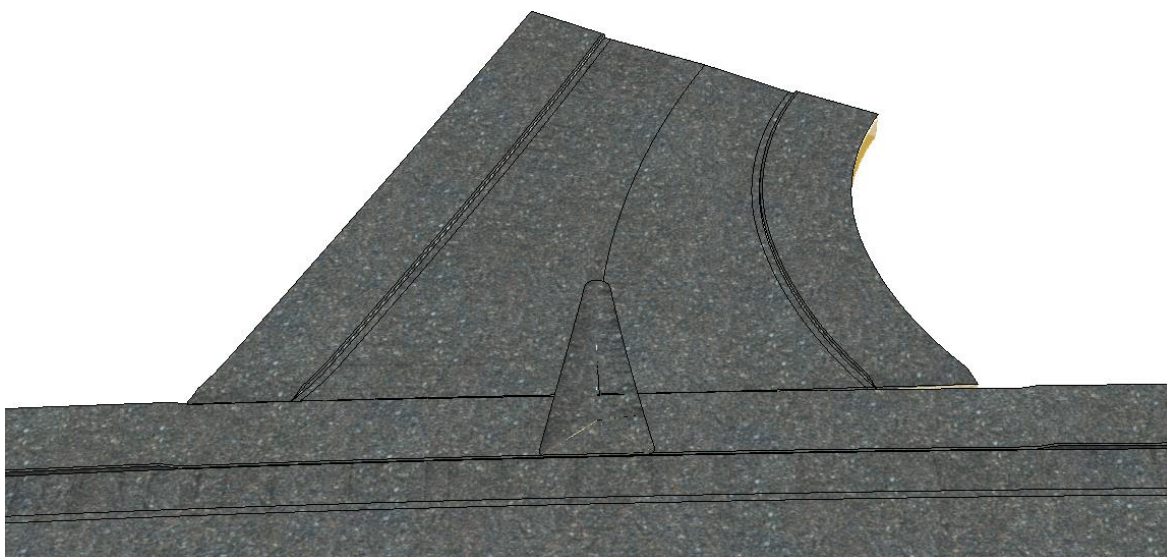

Figure 52 View of connection between Høylandsgata and FV44 (view from east)

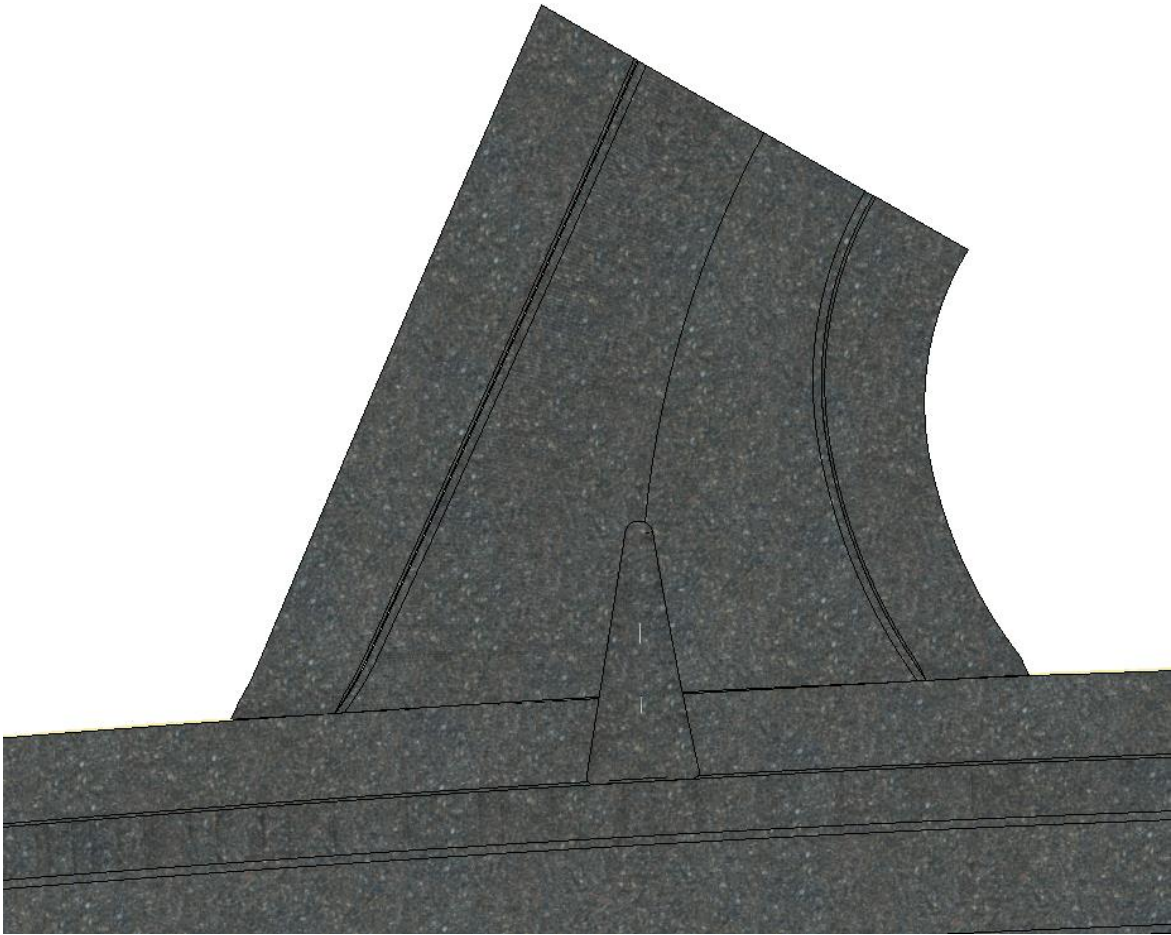

Figure 53 View of connection between Høylandsgata and FV44 (view from top)



Figure 54 View of connection between Skjærebergveien and FV44 (view from south)



Figure 55 View of connection between Skjærebergveien and FV44 (view from top)

Which road:	What:	Which page(s) in appendix:
Høylandsgata	3D model	81
	Horizontal alignment	82
	Vertical alignment	83
	List of surfaces	84
	Input data for surfaces	84
Skjærebergveien	3D model	71
	Horizontal alignment	72
	Vertical alignment	73
	List of surfaces	74
	Input data for surfaces	74
Skjærebergveien in	Horizontal alignment	77
	Vertical alignment	78
Skjærebergveien ut	Horizontal alignment	79
	Vertical alignment	80

Table 7 Where to find what in appendix for two exits

3.4.4.4 Roundabout design – South

Next intersection is roundabout – south. When designing it, handbook V121 Geometrisk utforming av veg- og gatekryss and N100 Veg-og gateutforming from Statens Vegvesen. On picture below elements of a roundabout from V121.

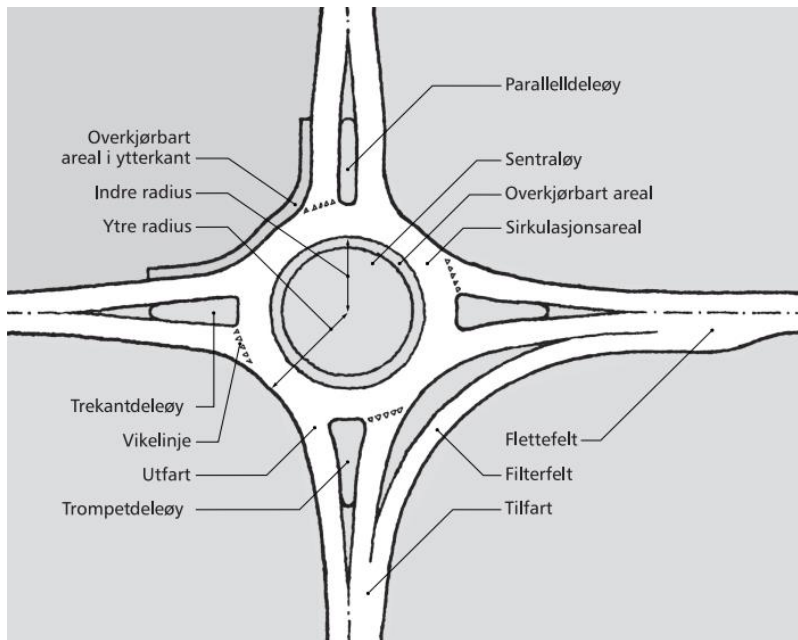

Figure 56 Different elements of a roundabout (Ulike elementer i en rundkjøring) (V121, 2014)

The first step of the design of the roundabout is to make a new road task which will be the circulation area of the roundabout – rund. sør sentraløya. Horizontal alignment of that line is *indre radius* (inner radius). Vertical alignment is constructed in that way to align with slope of FV44 (which is 3%) - northern part of roundabout has slope rising from center of roundabout, and southern part – declining, such solution is called superelevated roundabout and ensures good watering of roadway. Next step is to adjust all surfaces of the road, so it has the desired shape and dimensions as presented below.

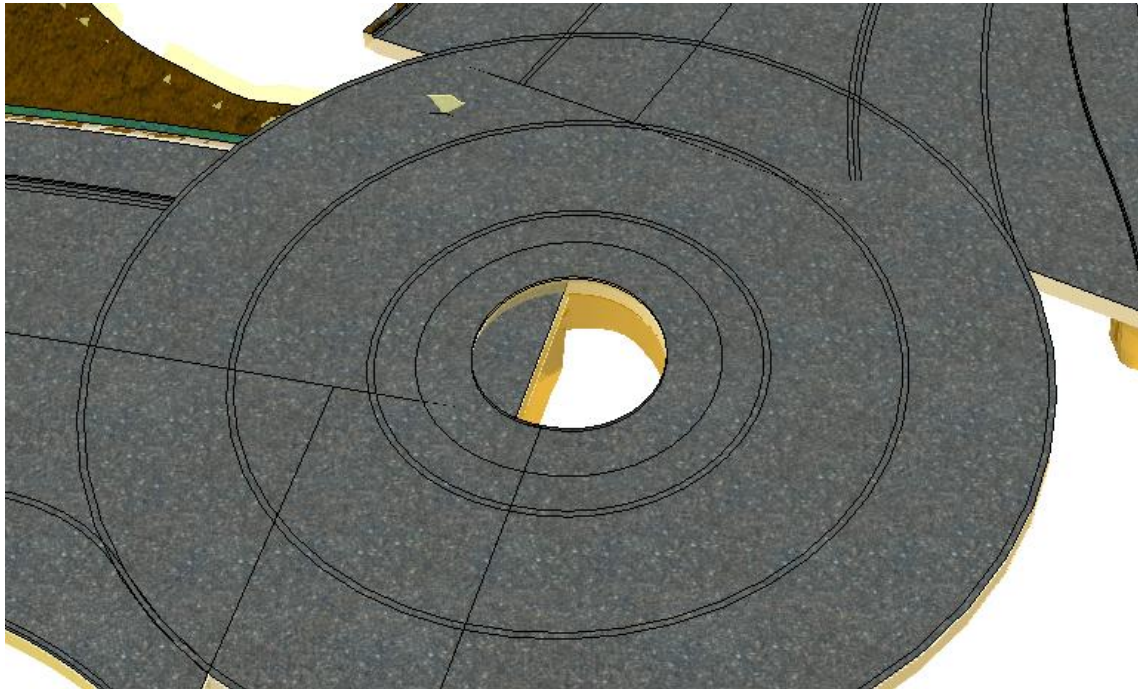

Figure 57 Prepared circulation area of roundabout (view from south)

The left side of the road task is traffic island, which consist of *overkjørbart areal* (truck apron) with width of 1.5m as existing and has 10cm high. Then the rest is a traffic island - 3.4m is the space where bushes can be planted and the remaining 3.4m is the radius of the hole in the middle.

The next step is to correct the vertical alignment of arms, so centerlines of each arm meet at the same level with the outer radius of the roundabout. The reason why FV44 was divided to two separate roads was to simplify that step. From profile 100.693 – northern part remains as FV44, and southern part is called FV44 sør.

The following step is to construct new boundary lines for each arm.

For the connection between Hillevågstunnelen and FV44 sør, two lines are constructed:

- Avgr. Rund. Sør FV44 sør til Tunnelen midt which will allow to make a smooth vertical transition between the line dividing left and right turn for traffic coming from tunnel and to two lanes for exiting traffic from roundabout to FV44 sør as presented on the picture below (northern line).
- Avgr. Tunnelen til FV44 sør - outer roadway boundary for these roads (on picture southern line).

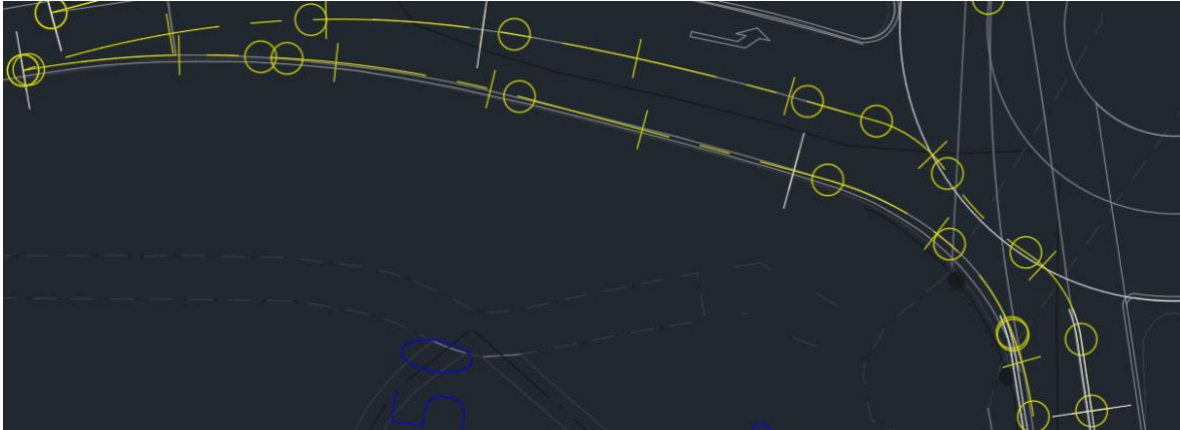

Figure 58 Location of lines avgr. rund. sør FV44 sør til Tunnelen midt and avgr. Tunnelen til FV 44 sør

Using these two lines it is possible to change the road from the following situation:



Figure 59 Level difference between FV44 sør, Hillevågstunnelen and rund. sør sentraløya (view from FV44 sør)

To the new situation:

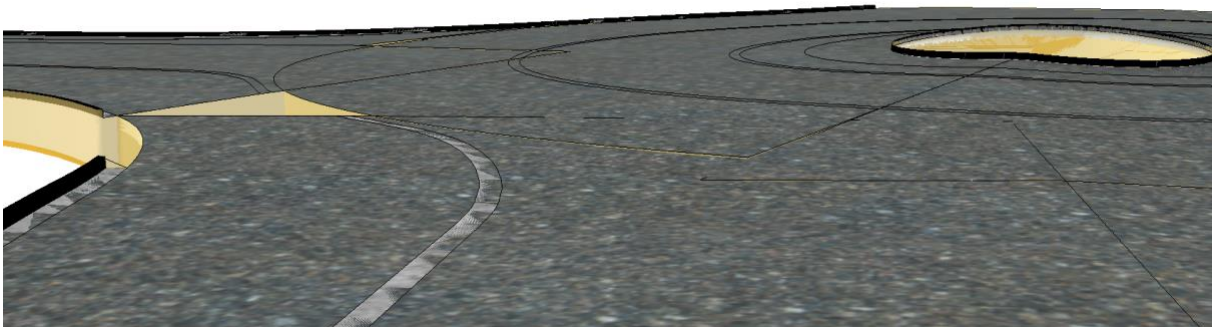

Figure 60 Leveling between FV44 sør, Hillevågstunnelen and rund. sør sentraløya (view from FV44 sør)

In the figure above, it is visible that there are two remaining problems. First, there is a hole for the right turn from Hillevågstunnelen to FV44 sør, which can be eliminated by moving the boundary where both roads start/finish further, but that brings the second problem –

overlapping roads. Such a situation of overlapping roads needs to be curtailed as much as possible, since it gives wrong calculations for the number of materials for road construction. In order to solve those two problems, a new boundary line is constructed – rund. utvidelse tunnelen til FV44 sør as presented in the figure below.

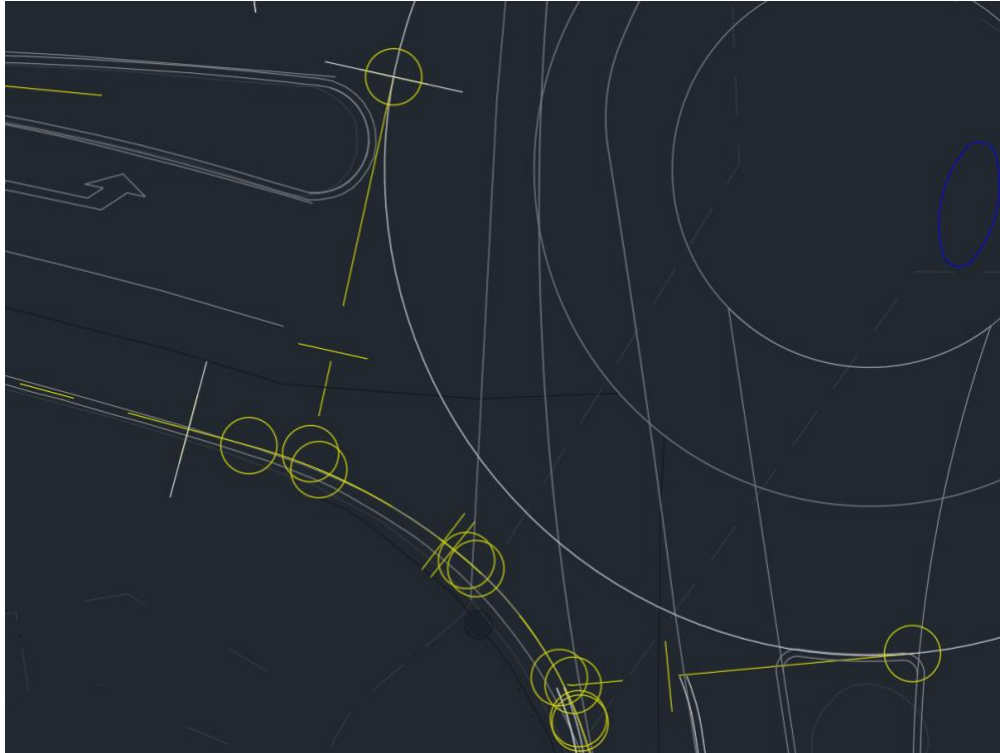

Figure 61 Location of rund. utvidelse tunnelen til FV44 sør

The line is constructed in such a way to be perpendicular to CL – FV44 sør and CL – Hillevågstunnelen and at the same time tangent to the outer radius of the roundabout (excluding shoulder of roundabout). Being perpendicular to center lines will allow precise cut of roads to exact profile so there will be no overlaps nor holes between roundabout and arms. For the part between arms, the boundary line follows exactly avgr. Tunnelen til FV44 sør. Since there cannot be any level differences, there was a need to draw vertical geometry as well, for the background picture will be use both arms. Once a line is used for the road surface, the roundabout is widened and arms need to be delimited to profile where centerlines are crossed with rund. utvidelse tunnelen til FV44 sør. The last step is to cut the outer shoulder and curbstone, so it is only between two arms and not between the roundabout and the arm. Outcome presents as following where curbstones are fit and there are no level differences between roads which ensure smooth transition:

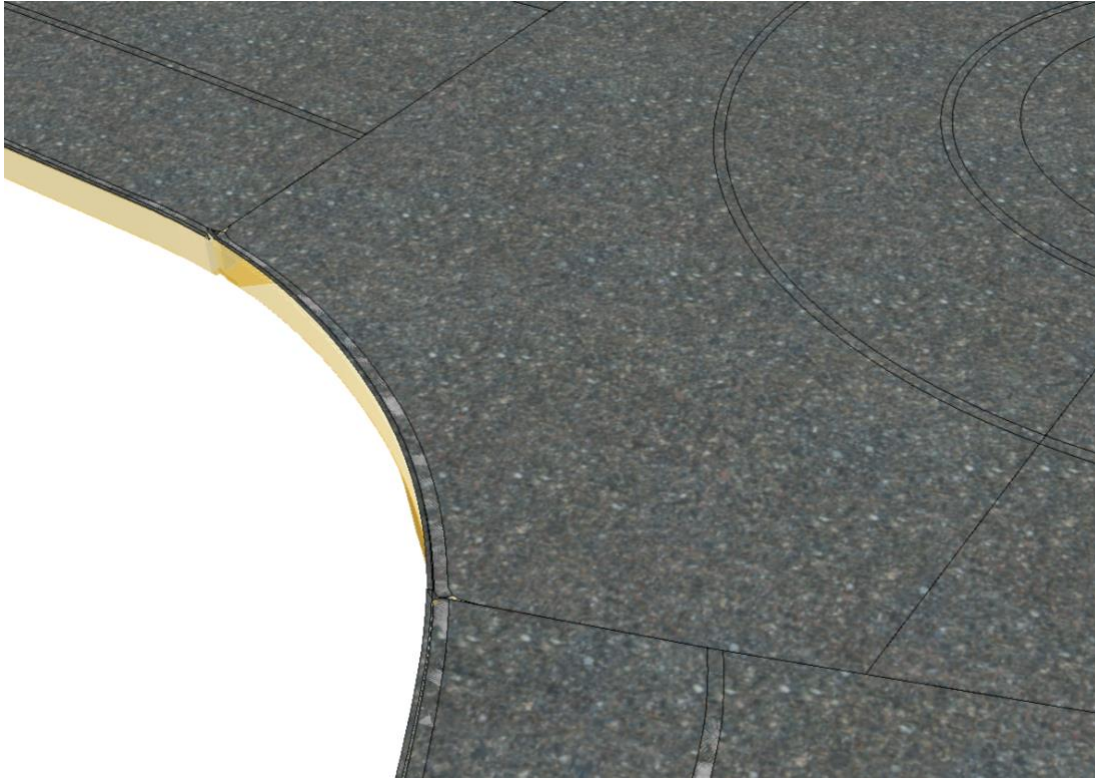

Figure 62 Finished connection of Hillevågstunnelen, FV44 sør and roundabout (view from FV44 sør)

The same procedure is for connections between FV44 to Hillevågstunnelen and between FV44 sør to FV44. The only difference is that between FV44 and tunnelen there is one more lane (two for driving straight to south and one for right turn, which also was fit to ensure correct levels).

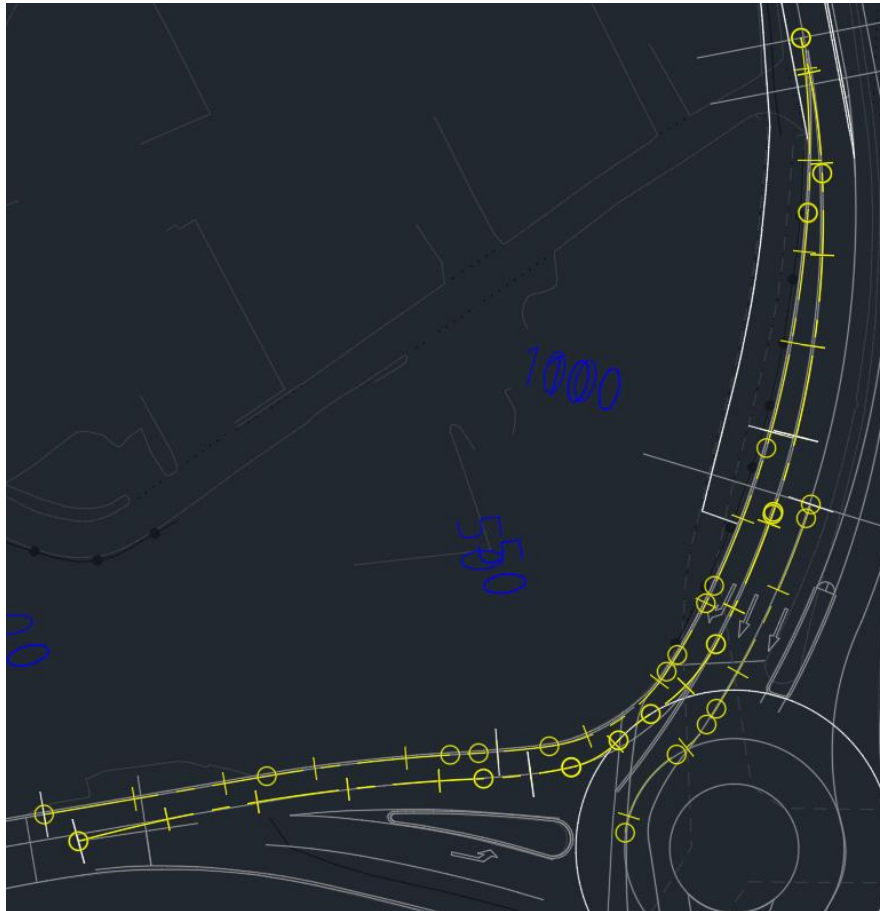

Figure 63 Boundary lines between FV44 and Hillevågstunnelen

Going from the outer part of roads to inside, lines have names: avgr. rund. sør Tunnelen til FV44 ytre, avgr. rund. sør FV44 til Tunnelen midt and avgr. rund. sør Kollektiv FV44 til tunnelen. It was ensured that the length of the middle one is the full length of both right turn from FV44 to tunnelen and all the way down when two lanes for incoming traffic to the tunnel merge. In this case, differences in levels are huge – 80 cm.:

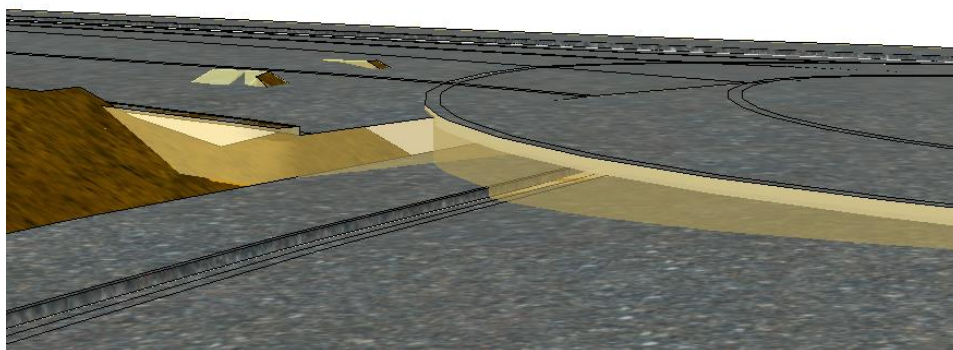

Figure 64 80 cm gap between roundabout and existing lane to Hillevågstunnelen (view from tunnel)

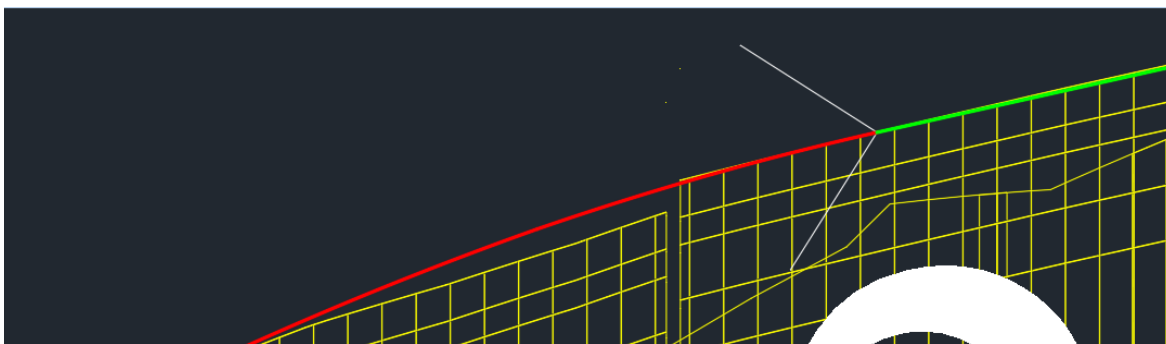

Figure 65 80cm gap between roundabout and existing lane to Hillevågstunnelen in vertical alignment

The red and green line in the picture above presents avgr. Rund. sør Tunnelen til FV44 ytre and how the line is leveling connection. The boundary lane for the roundabout for these roads is called rund. utvidelse fv44 til tunnelen. Ready connection presents as follow:

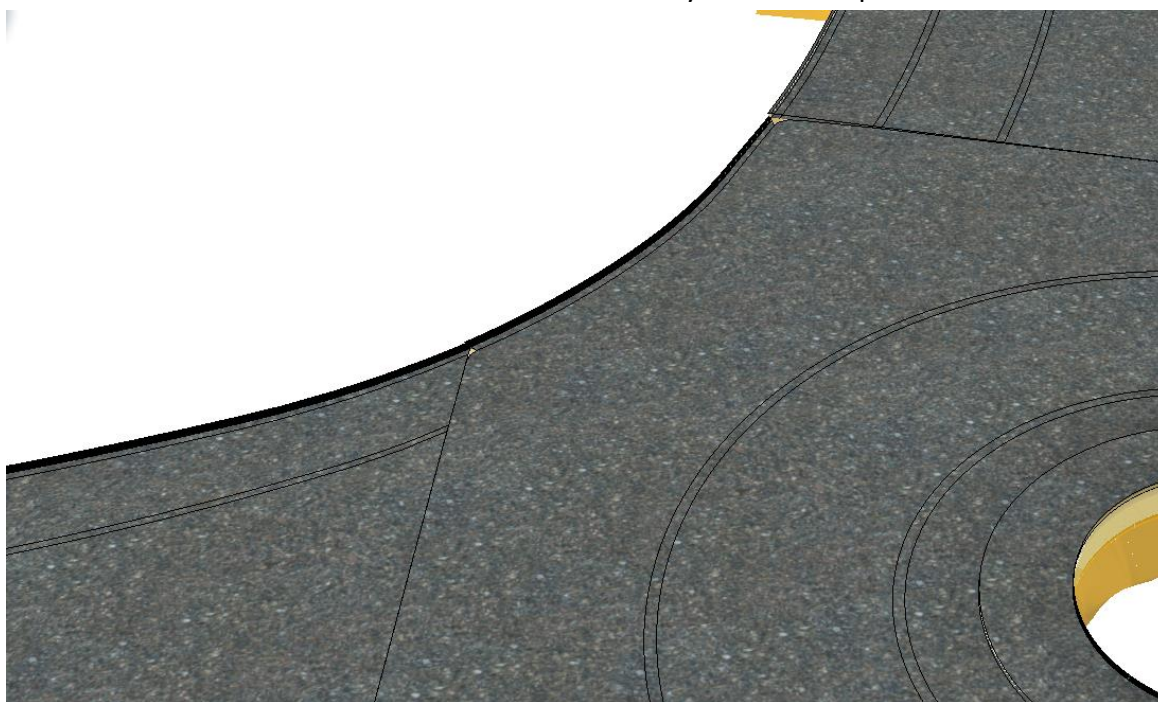

Figure 66 Finished connection of Hillevågstunnelen, FV44 and roundabout (view from south)

The last connection is between FV44 sør and rest of FV44. Three lines were constructed, avgr. Rund. sør FV44 sør til rund, avgr. rund. sør FV44 til rund (both lines could be merged to one, but since they were constructed separately, there is no need to merge them after – does not change outcome) and avgr. rund. sør øy en del. Those lines construct traffic island which separates circulation area and bike lane.

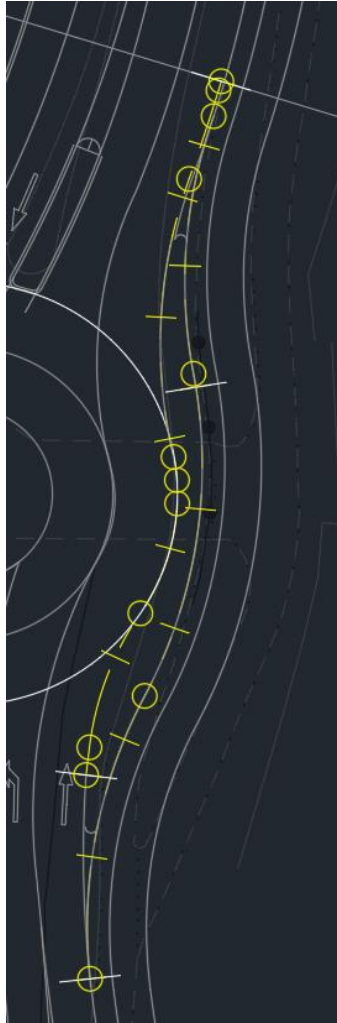

Figure 67 Boundary lines between FV44, FV44 sør and roundabout

The rest of the procedure is the same as the previous. The boundary lane for the roundabout is called rund. utvidelse fra sør til nord fv44. The only difference will be that for length here, the outer lane will be limitation and not curbstone. Below ready connection but without island, bike path and sidewalk.

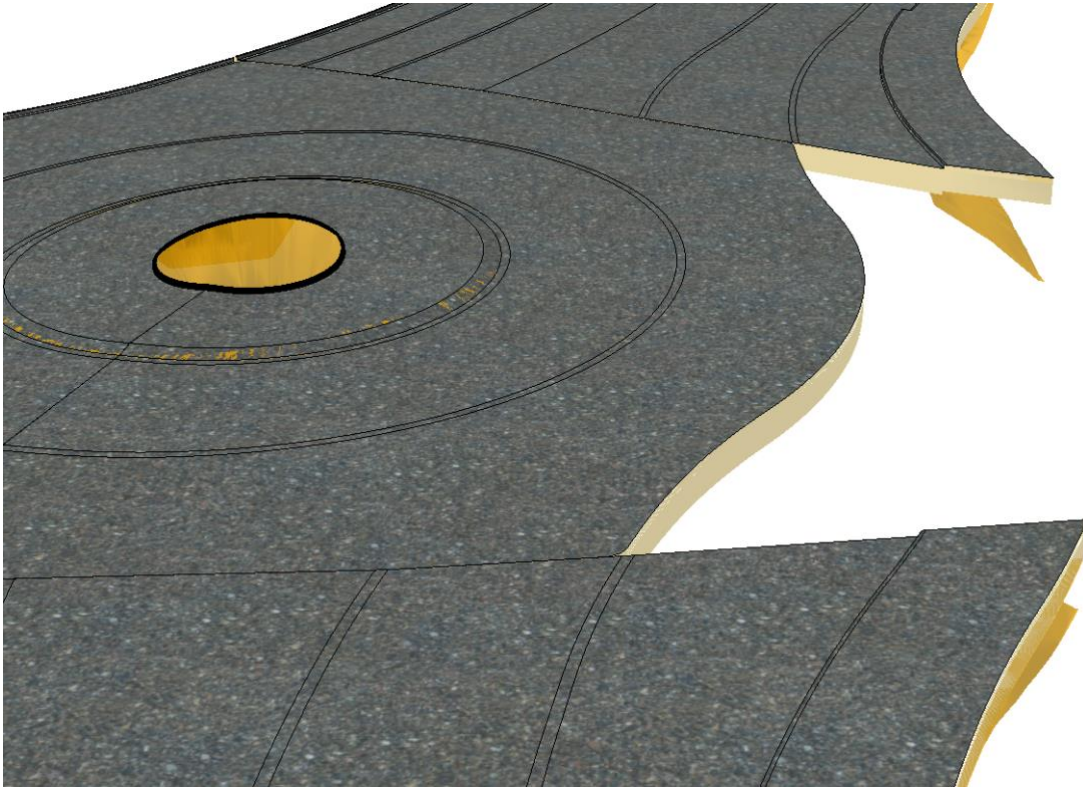

Figure 68 Almost finished connection between roundabout, FV44 sør and FV44

The second last step is to construct the missing part. The fastest way is to make a new road task - rund. sør øst sykkel og fortau, based on line task rund. utvidelse fra sør til nord fv44, where the left side will be empty, and the right side will be limited by avgr. Sykkel høyre for bike path and new line avgr. rund. sør fortau which will set a boundary for whole missing part. Below ready connection.

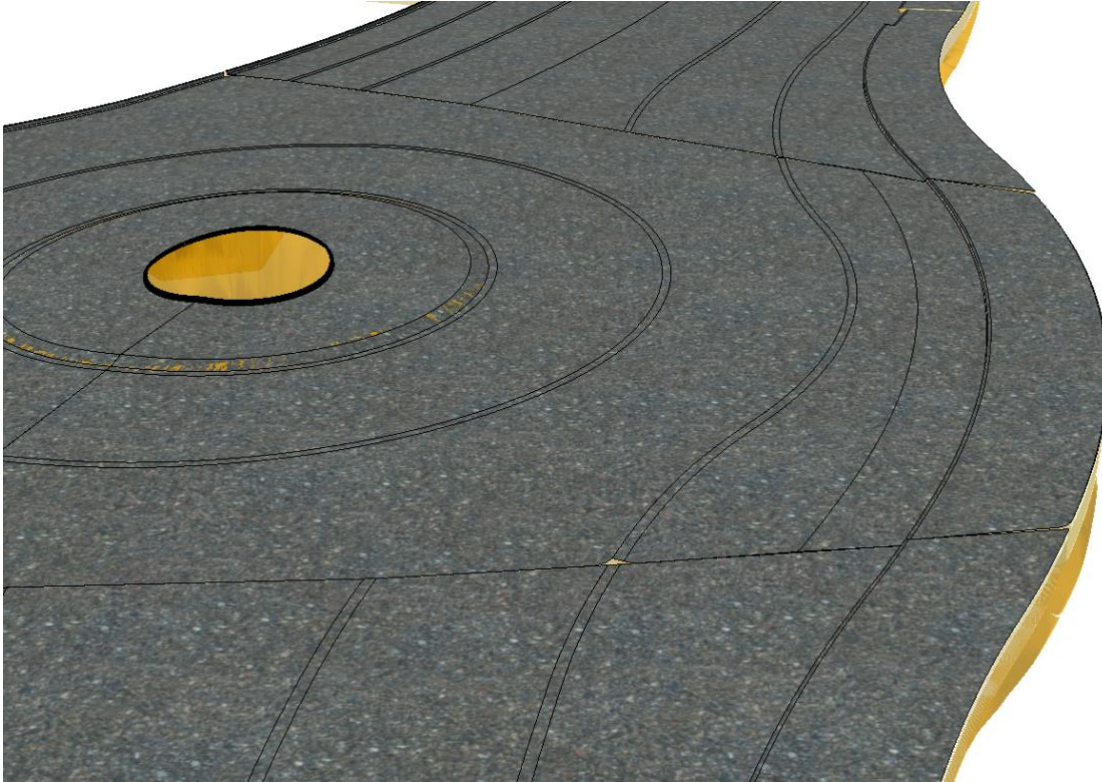

Figure 69 Connection between roundabout, FV44 sør and FV44 (view from FV44 sør)

The last step is to construct the missing secondary islands (deltidsøyer). Detailed process is in chapter 6.4.6.

For that intersection, four islands are constructed – each for each arm plus island between driving lane and bike lane. Lines used are: deltidsoya FV44, deltidsoya FV44 sør, deltidsoya Hillevågstunnelen and avgr. rund. sør øy mellom rund og sykkel.

Below finished 3D model of the southern roundabout:

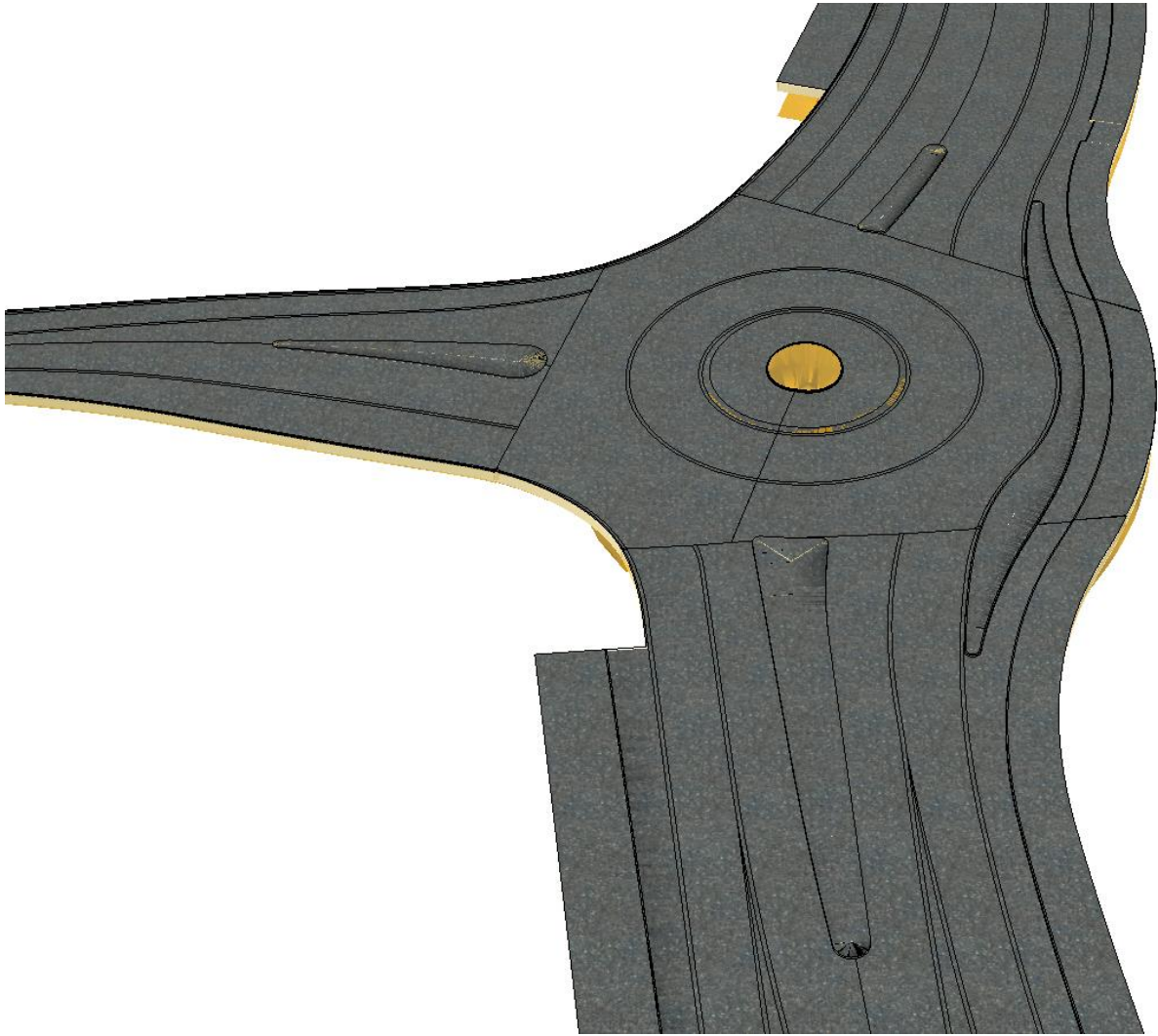

Figure 70 Ready roundabout (view from south)

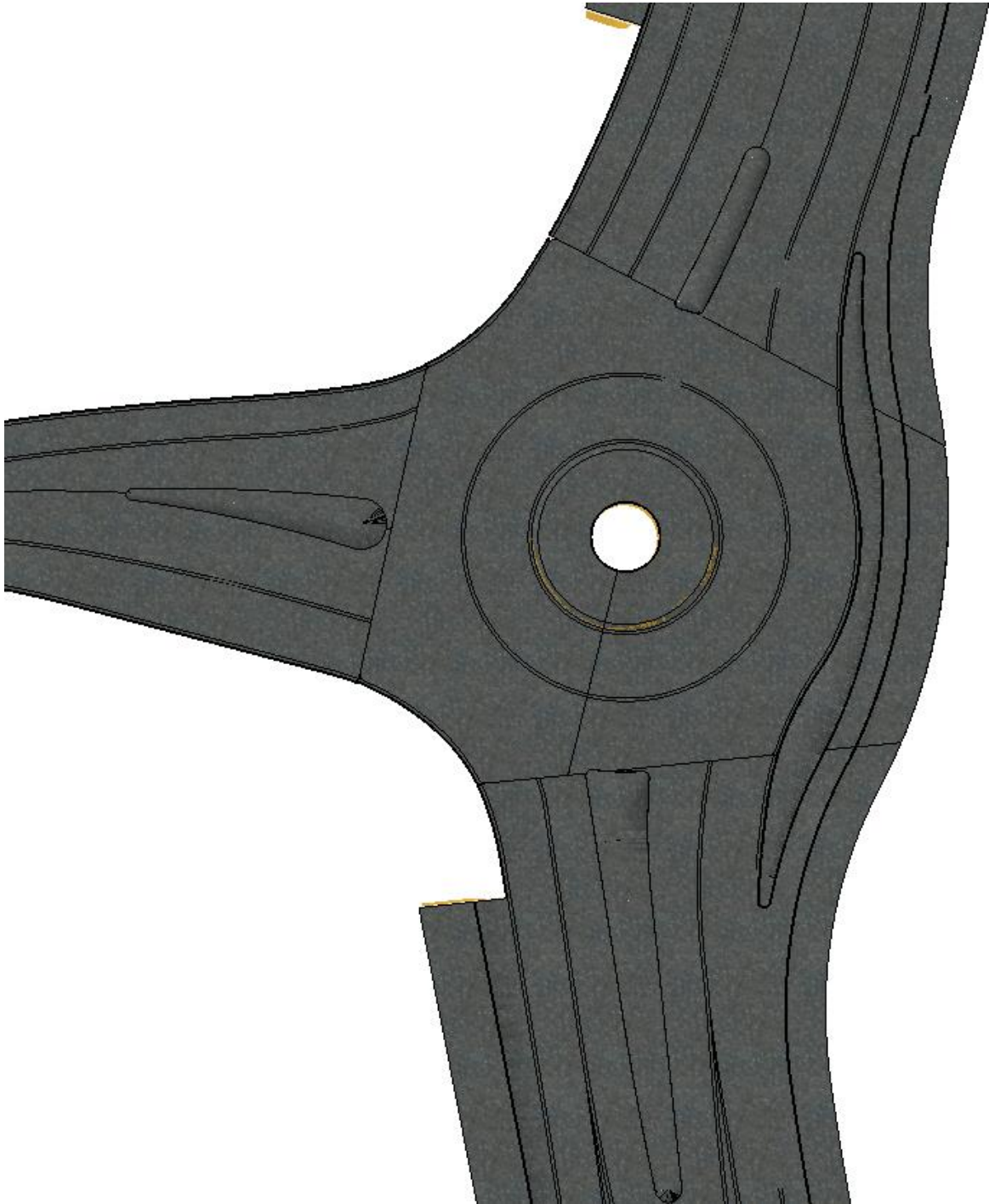

Figure 71 Ready roundabout (view from top)

Which road:	What:	Which page(s) in appendix:
Hillevågstunnelen	3D model	20
	Horizontal alignment	21
	Vertical alignment	22
	List of surfaces	23
	Input data for surfaces	23
Rund. Sør sentraløya	3D model	26
	Horizontal alignment	27
	Vertical alignment	28
	List of surfaces	23
	Input data for surfaces	23
Rund. Sør øst sykkel og fortau	3D model	32
	Horizontal alignment	33
	Vertical alignment	34
	List of surfaces	35
	Input data for surfaces	35
Rund. Utvidelse fv44 til tunnelen	Horizontal alignment	37
	Vertical alignment	37
	List of surfaces	38
Rund. Utvidelse tunnelen til fv44 sør	Horizontal alignment	39
	Vertical alignment	39
	List of surfaces	40

Table 8 Where to find what in appendix for elements of roundabout south

3.4.4.5 Roundabout north

As mentioned in chapter 2 Principles of Bussveien in Stavanger, the northern roundabout will be bus prioritized, with bus lane going through the middle of the central island. Thus, the design of this roundabout will be very different from the previous one.

The first step was to make two central islands for the roundabout based on line tasks rund. nor. h. sentraløya and rund. nor. v. sentraløya. They are not the same size – the east one is slightly bigger. The reason for that is that if they were the same smaller size, it does not slow down sufficiently cars driving in the roundabout, which is not safe (this information was given to author by road planner from County), making the island bigger, forcing cars to take sharper turn and could result in blocking roundabout by trucks. Then two new line tasks were constructed – rund. nor. H. kjørefelt and rund. nor. V. kjørefelt. Lines go from FV44 along shoulder for bus lane, around central island and continue alongside bus lane shoulder. These lines will be used to construct circulation lane of roundabout, so vertical alignments are constructed as well, in a way that they follow vertical alignment of FV44. Then two extra lines: rund. nor. V. innkjøring and rund. nor. H. innkjøring are constructed which will work as boundary lines for circulation lane and will ensure smooth transition of levels of roundabout and FV44 – method 1 was used. Then FV44 is delimited for the distance of intersection by *Skulder 1*. On picture below CL – FV44 and those four lines.

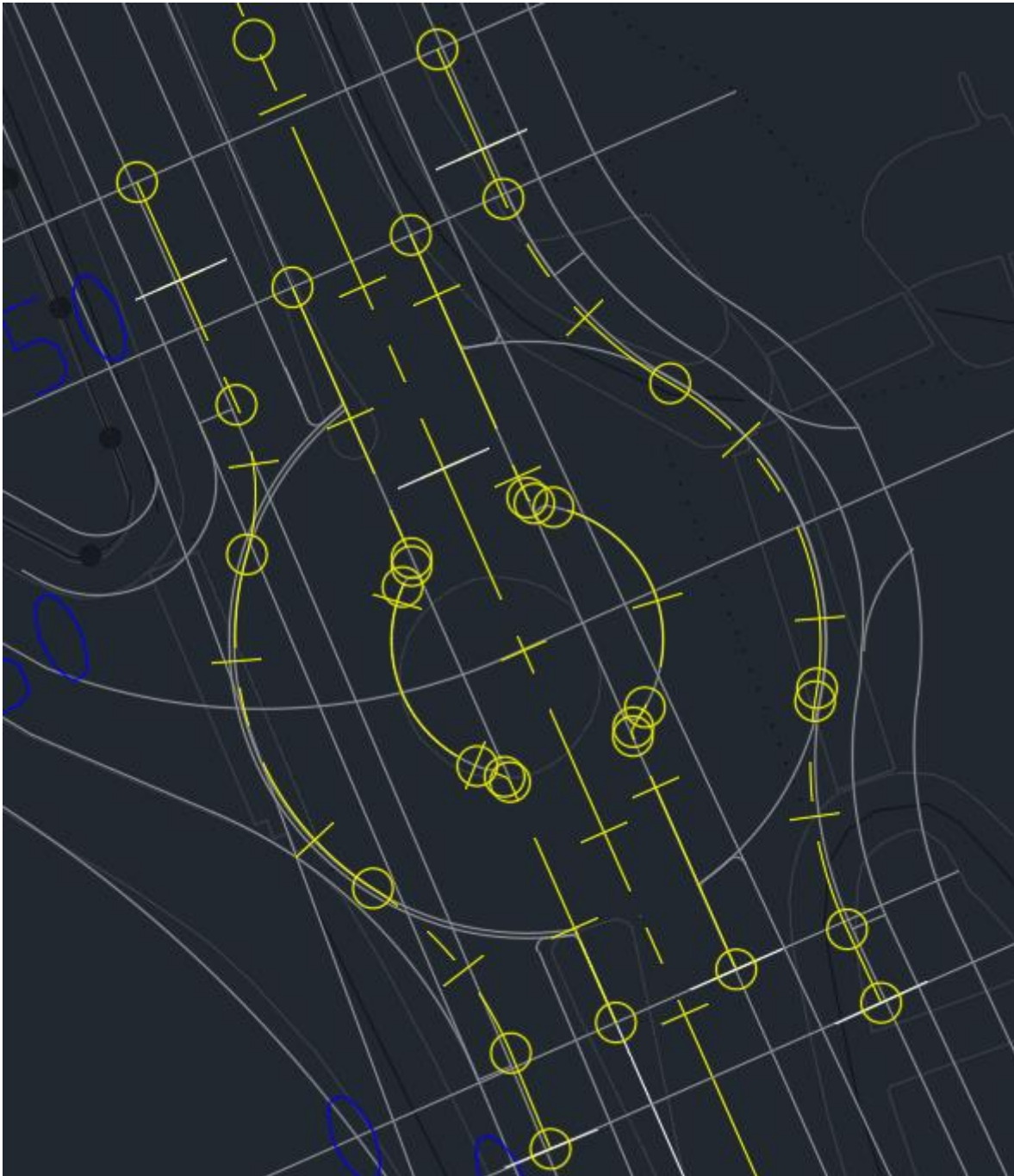

Figure 72 Location of rund. nor v. and h. kjørefelt (closer to CL - FV44) and rund. nor. v. and h. innkjøring

Result for the right side:



Figure 73 Rund. nor. h. kjørefelt after boundary of rund. nor. h. innkjøring

Next step is to adjust bike lane in a way that it will work as exits from roundabout to the east and west side. After consultation with Rogaland County, it was decided just to present in the model that there is a possibility to exit roundabout and not need to show bigger part of secondary roads. Adjustment of the bike path is done by construction of two boundary lines – rund. Nor. V. and h. ytre (with vertical geometry) then curbstone is lowered for crossing of exits to the east and the west. Then the right side is done. For the left side, the next step is to construct border line – rund. Nor. V. fortau - for sidewalk since sidewalk has not the same width (width is adjusted to adjacent retain walls from houses). The final step is to construct 4 median strips. The final intersection is presented below.

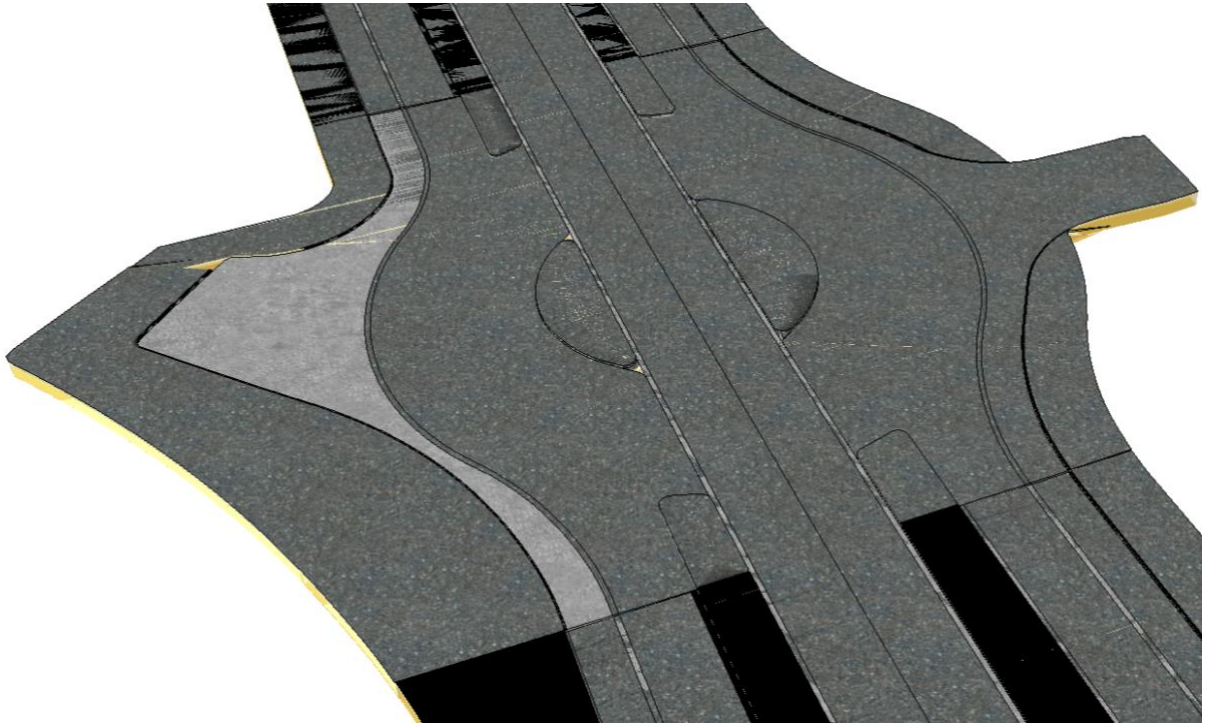

Figure 74 Ready roundabout north (view from south)

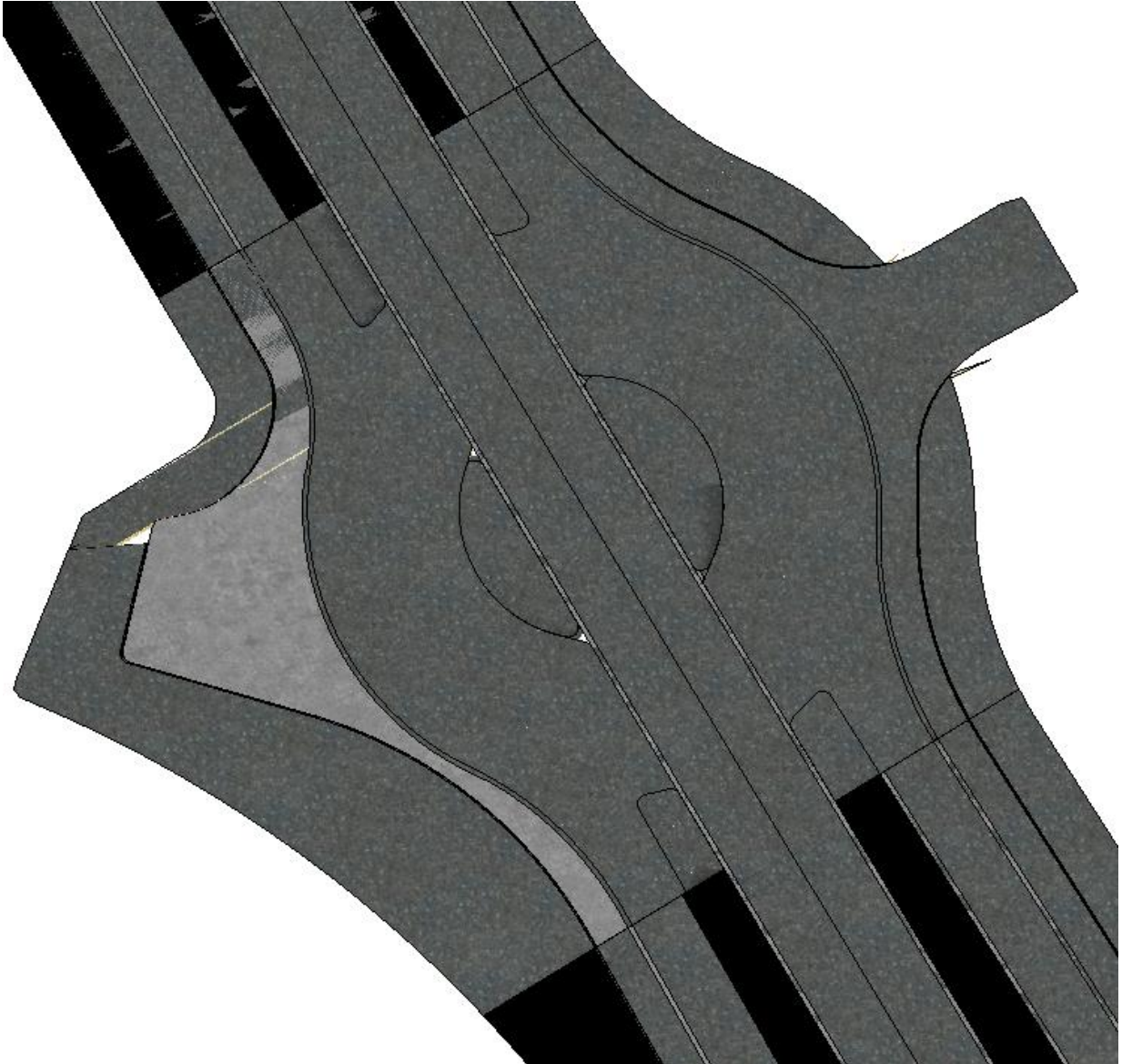

Figure 75 Ready roundabout north (view from top)

For the left side there are some construction problems which are discuss in chapter 4.

Which road:	What:	Which page(s) in appendix:
Rund. North, right	3D model	87
	Horizontal alignment	89
	Vertical alignment	90
	List of surfaces	91
	Input data for surfaces	91
Rund. North, left	3D model	93
	Horizontal alignment	95
	Vertical alignment	96
	List of surfaces	97
	Input data for surfaces	97

Table 9 Where to find what in appendix for roundabout north

3.4.4.6 Islands and median strips (traffikøyer and midtdeler)

The main purpose of traffic islands is to make it easier and safer for drivers to drive through intersection (V121, 2014, p.27). Additionally for signal-controlled intersection traffic island allows to place traffic signal pole (V121, 2014, p.42) and should have minimum 1.5m width (N100, 2022, p.74), which is fulfilled with proposed width of minimum 2.5m. Another demand for the construction of traffic island is in a situation where there is a pedestrian crossing going through the island – such construction is called refuge island. Such a situation is in two places – Strømsbrua and Høylandsgata. Traffic island needs to be physical (generally traffic island can be either physical or painted), have at least 2m width next to intersection and extend at least 2m beyond the crossing point (N100, 2022, p.99). Those requirements are fulfilled for both islands.

The last location of the islands is the southern roundabout; in the 2D proposal there are no traffic islands for the north roundabout. Demands from Statens Vegvesen are that there must be traffic islands dividing traffic entering and exiting roundabout and constructed in the way ensuring good turning. Additionally, they must be physical, have length of at least 10m and width of minimum of 2m (V121, 2014, p.65-65). All these demands are fulfilled for the southern roundabout.

Concerning median strips, Statens Vegvesen demands that they have minimum width of 1.5m (N100, 2022, p. 17). This is only partially not fulfilled for distance from the southern roundabout to profile 350 of FV44 due to very limited space.

When it comes to construction, the procedure is identical for both islands and median strips. First horizontal alignment is constructed, the center line is located in place where the lower part of curbstone is. Then vertical alignment is drawn. Two methods are used in the project, one faster by picking up lines automatically. Lines picked are the surface of FV44. The second method is to draw manually vertical alignment following the FV44 surface. Although the 1st method is more precise, there is one main issue – when lines are chosen automatically, alignment is drawn as a set of straight lines which results in hundreds of lines for distance of few meters, such huge data set makes it impossible to edit if any lines were not read properly – software crashes every time. That is the reason why some islands and median strips have manually drawn vertical alignment.

The next step is to construct a road task where left side is restricted by the center line and the right side consists of a curbstone and curbstone surface with width of 2m (for wider traffic islands up to 3m). All islands and median strips are drawn clockwise except rund. Nor. H. sentraløya, therefore restriction is for the left side.

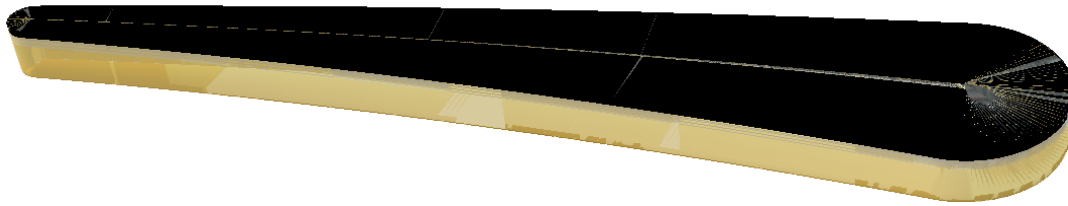

Figure 76 Example of ready traffic island (trafikkøya Hillevågstunnelen)

Below is a full list of all median strips and traffic islands.

- | | |
|--------------------------------------|--------------------------------|
| ↷ Høylandsgata øya | ↷ Strømsbrua trafikkøya |
| ☰ Midtdeler nord | ☰ T kryss midtdeler |
| ↷ Midtdel h. til nord | ↷ Midtdel T kryss h. nord |
| ↷ Midtdel høyre mellom bru og nord | ↷ Midtdel T kryss h. sør |
| ↷ Midtdel v. til nord | ↷ Midtdel T kryss v. nord |
| ↷ Midtdel venstre mellom bru og nord | ↷ Midtdel T kryss v. sør |
| ☰ Midtdeler rund. sør | ↷ T kryss trafikkøya |
| ↷ Midtdel fv44 nord venstre | ☰ Traffikøyer rund. sør |
| ↷ Midtdel fv44 sør høyre | ↷ trafikkøya FV44 |
| ↷ Midtdel FV44 sør venstre | ↷ Trafikkøya FV44 Sør |
| ↷ rund. nor. h. sentraløya | ↷ Trafikkøya Hillevågstunnelen |
| ↷ rund. nor. v. sentraløya | |

Figure 77 Full list of all line tasks for median strips and traffic islands

Below is a presentation of the location of all traffic islands and median strips.

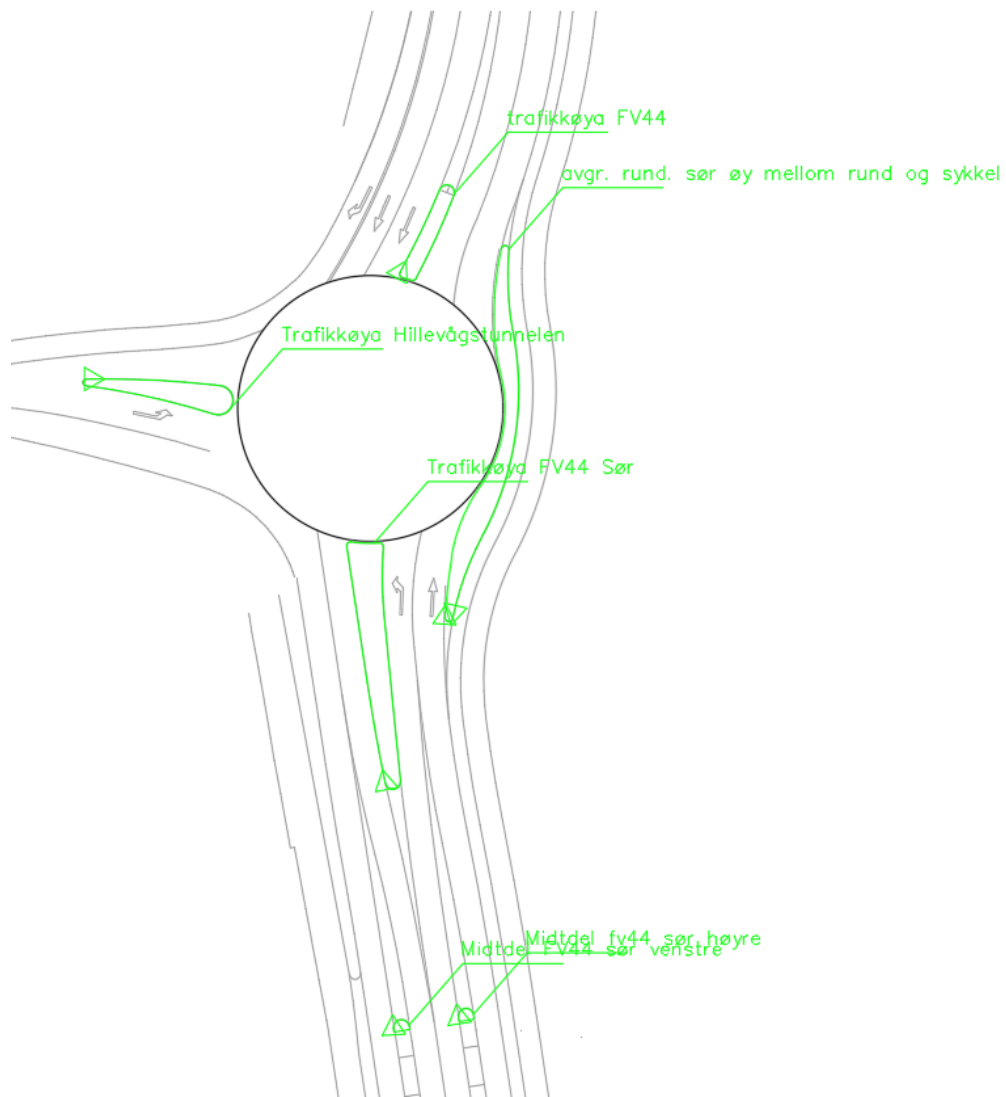

Figure 78 Location of traffic islands and rounding of median strips on the southern roundabout

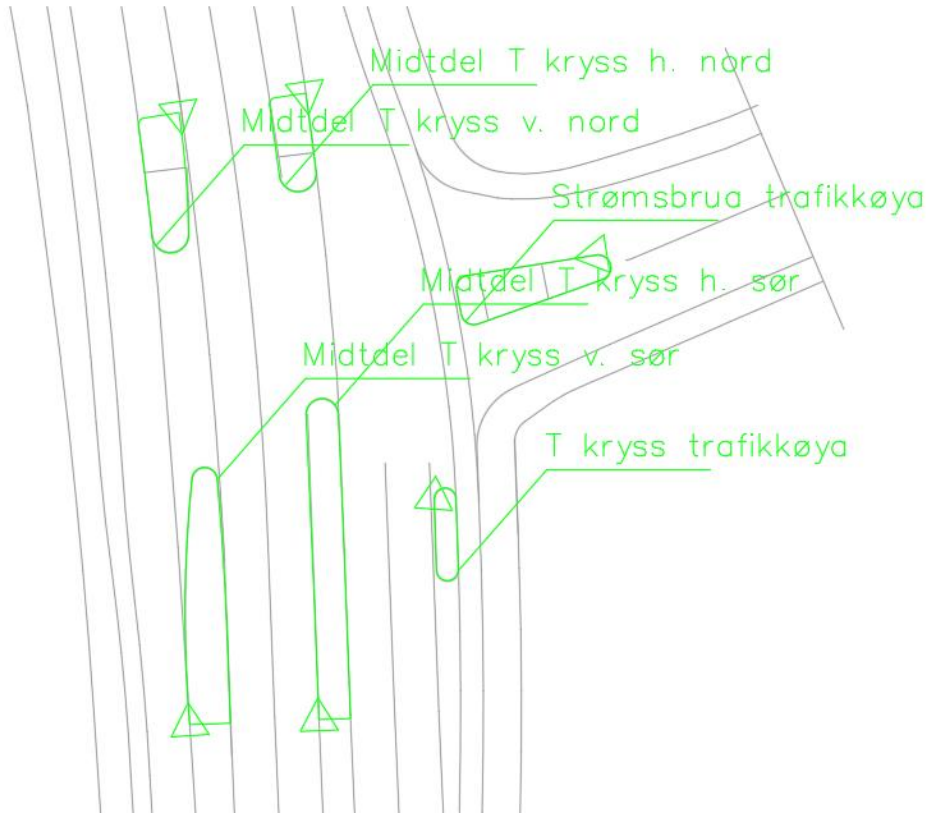

Figure 79 Location of traffic islands and rounding of median strips on T-intersection

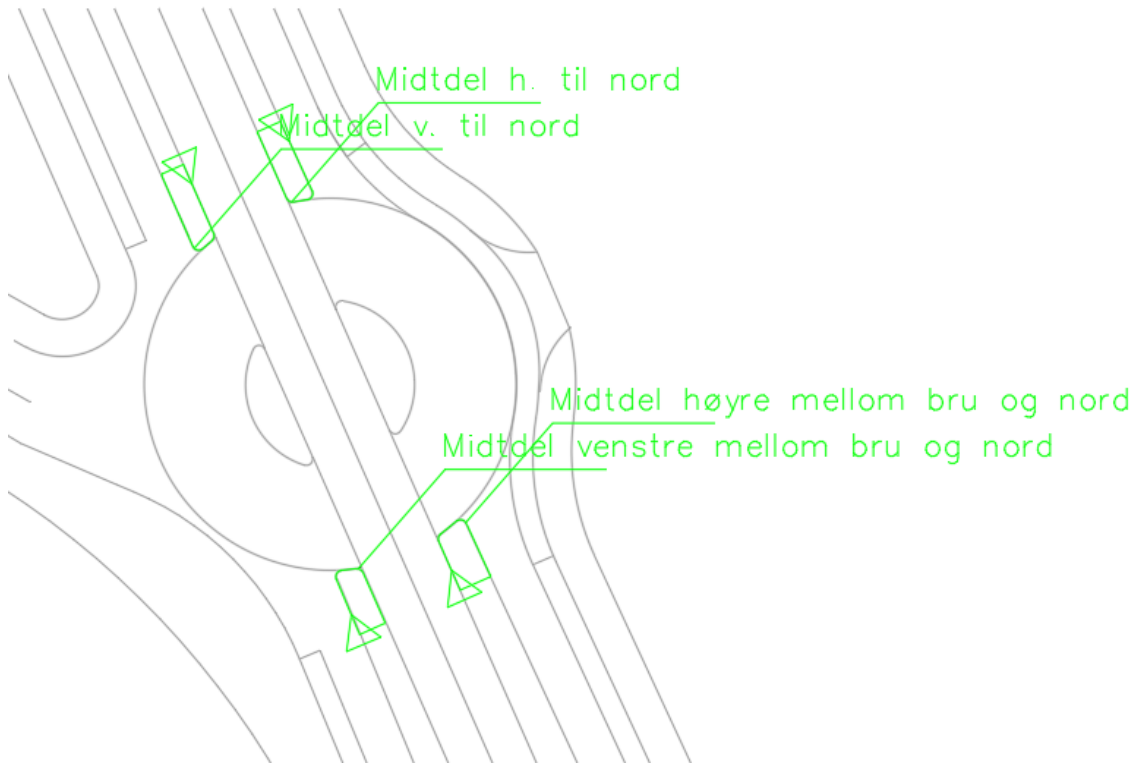

Figure 80 Location of traffic islands and rounding of median strips on the northern roundabout

4. Discussion

4.1 Model errors

While working on the project from the very beginning to the end, there were technical problems with the software. This problem includes both Novapoint and AutoCAD and led to many situations where the same parts were done twice. One of the most prevailing problems is that Novapoint just stops working without any precise reason. In that case a message error shows or before shutting down software or after software shutdown itself and when Novapoint is switched on again. To show the scale of the problem – during the whole project more than 40 times such errors were encountered. Error message presented below.

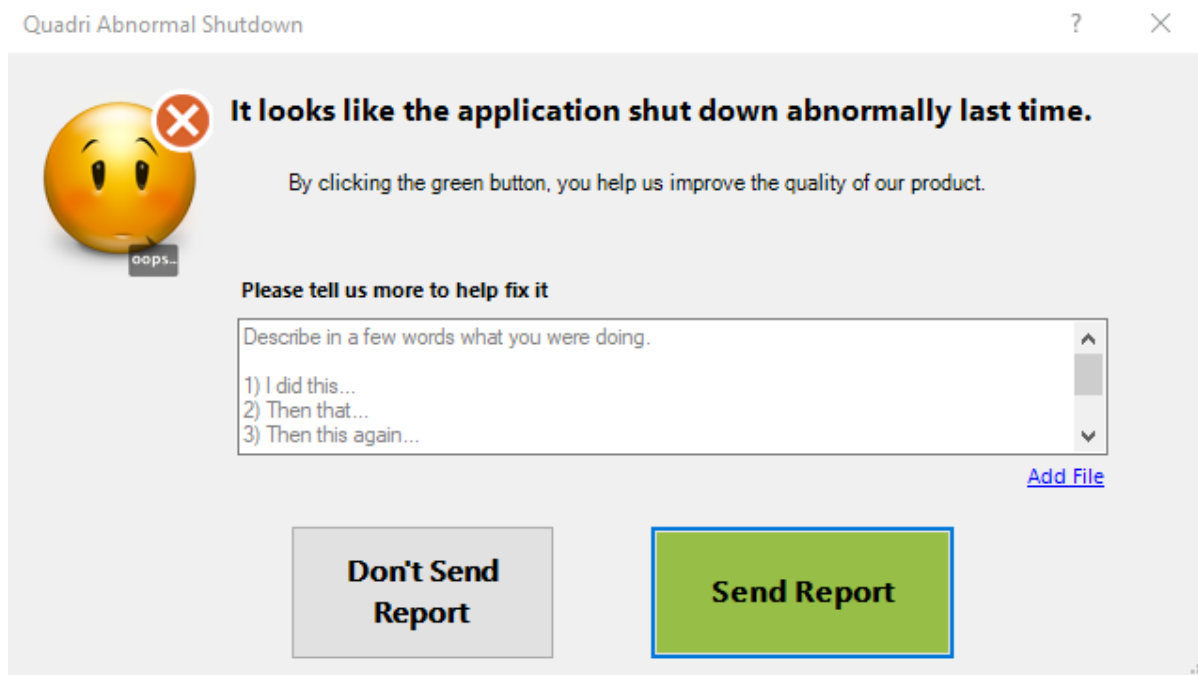

Figure 81 Typical fatal error in Novapoint

The second problem occurs in AutoCAD. When drawing vertical alignment, using option *Velg linje* which allows to use lines from drawing and not to draw manually, AutoCAD shuts down if user wants to edit or delete chosen lines. Furthermore, lines are saved already and if not correct the only option to have proper vertical alignment is to delete line task in NovaPoint and make a new one. Thus, horizontal alignment needs to be done twice.

Another problem happened a few times and is not nearly so common as 1st one. Twice Novapoint met a problem with saving and closing itself. In that case, all progress which was made since the last saving was lost. Even though Novapoint saves progress automatically each time when button *Finish* is chosen, sometimes it may take a long time to input all the changes in road surfaces, resulting in lost progress. Below is a screenshot of *Operasjon feilet* message.

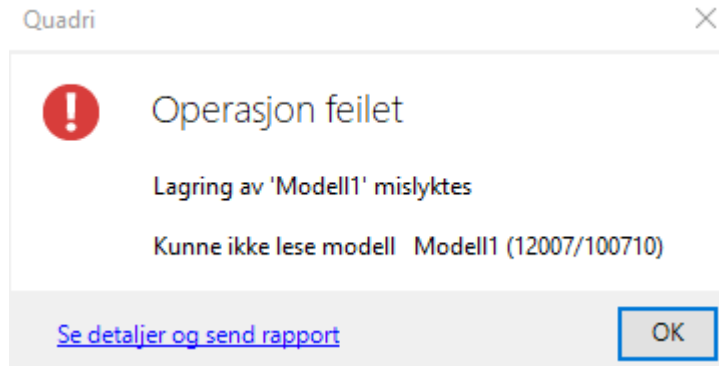

Figure 82 Operasjon feilet - error occurring when trying to save

4.2 Superelevation

Once the 3D model was constructed, one issue, which was the result of author's lack of experience, was discovered. Namely, generally when a road is constructed, for the part on curvature, superelevation should be implemented. Superelevation is a situation where cross fall (helling) of road is going in one direction – usually the highest point is location of center line but in that case – one edge of road. The purpose is to counteract lateral forces on vehicles and ensure good watering of the road (V120, 2014, p.37). Below presentation of superelevation.

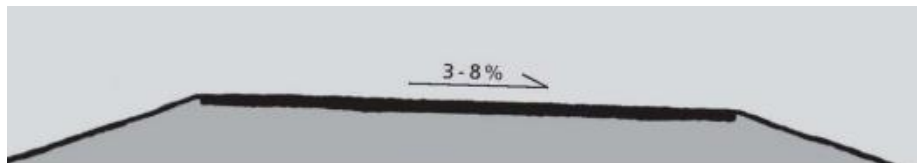

Figure 83 Cross fall, one-sided drop (Tverrprofil, ensidig fall (overhøyde)) (V120, 2014, p.37)

Although there are no regulations for superelevations for *gater* and only for *veier*, it is better to implement them if possible, since it makes driving more comfortable.

Now the question which can arise is how superelevation is made in Novapoint. There are two options. One is to manually change cross fall in road surfaces, but since there are no guidelines from Statens Vegvesen, it is hard to do it for inexperienced people like the author. The second option is to do it automatically and this option is quite hidden from the user.

In order to get superelevation automatically, following steps need to be taken. First step is to choose *breddeutvidelse* (width expansion) when constructing new road task as presented on figure below.

VEG	
OPPGAVE	DESIGN
n): 0.001	Veg Normal: Norway (2018) <input type="checkbox"/> Tverrfall
i): 41.872	Klasse: Gate <input type="checkbox"/> <u>Breddeutvidelse</u>
Vegstandard	

Figure 84 Width extension by default is not switch on in Novapoint

This option is used to widen the road on curvature since vehicles need more space there. In the picture below is the principal sketch for widening a 2-lane road from Statens Vegvesen handbook V120.

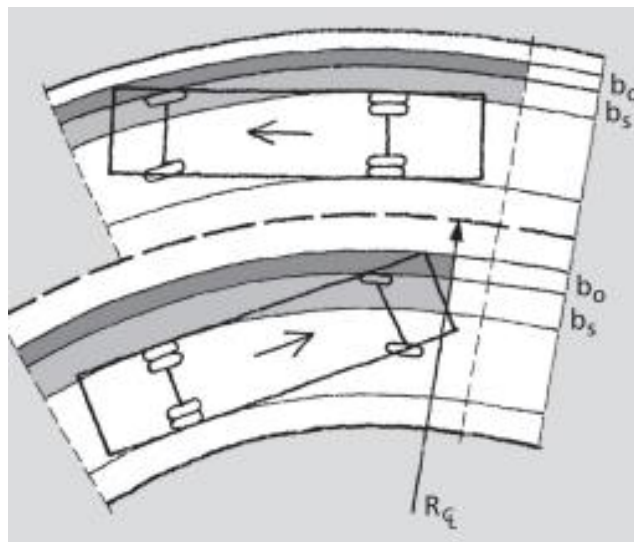

Figure 85 Principle sketch for widening for a 2-lane road

But since all the lanes of FV44/sør have width restricted by boundary lines from 2D proposal, it is not needed to widen roads more. Nevertheless, the width extension option in Novapoint adds one more characteristic to the model – automatically calculated superelevation.

Once the model is constructed there is a possibility to add width extension and thus superelevation by going to *Oppgave -> Innstillinger -> Tverrfall og breddeutvidelse*, and switch on option *breddeutvidelse* as presented below.

Tverrfall og breddeutvidelse ✕

Vegnormal: Norway (2018)

Vegstandard: Gate

Beregningsstrekning

Fra	Til
121.916	751.595

Innstillinger:

Tverrfall

Kjørebane:

Venstre	Høyre
-1.01 V. Kollektivfel	1.01 H. Kollektivfel

Tverrfall på rettlinje: -0.080 m/m

Bredde: 3.000 m

Tverrfall på midtd

Ytre skulder:

Knekt skulder

Venstre	Høyre
-2.01 V. Skulder 1	2.01 H. Skulder 1

Minimum helling på skulder: -0.080 m/m

Breddeutvidelse

Velg kjørefelt for breddeutvidelse:

Venstre	Høyre
<input checked="" type="checkbox"/> -1.02 V. breddeutvid	<input checked="" type="checkbox"/> 1.02 H. breddeutvid
<input type="checkbox"/> -1.03 Kjørefelt 2	<input type="checkbox"/> 1.03 Kjørefelt 2
<input type="checkbox"/> -1.04 Felt 2 breddeutv	<input type="checkbox"/> 1.04 Felt 2 breddeutv
<input type="checkbox"/> -1.05 Kjørefelt 3	<input type="checkbox"/> 1.05 Kjørefelt 3
<input type="checkbox"/> -1.06 Felt 3 breddeutv	<input type="checkbox"/> 1.06 Felt 3 breddeutv
<input type="checkbox"/> -1.07 Kjørefelt 4	<input type="checkbox"/> 1.07 Kjørefelt 4
<input type="checkbox"/> -1.08 Felt 4 breddeutv	<input type="checkbox"/> 1.08 Felt 4 breddeutv

Figure 86 Width extension switched on after constructing whole model

Then when clicked *Beregn* (calculate), a window with cross slopes and width extension will be presented like one below.

Venstre			Høyre		
	Profil	Helling		Profil	Helling
1	118.311	-0.080	1	118.311	0.080
2	177.816	-0.080	2	177.816	0.080
3	200.732	-0.030	3	228.232	-0.030
4	243.176	-0.030	4	270.676	-0.030
5	273.850	0.037	5	273.850	-0.037
6	397.634	0.037	6	397.634	-0.037
7	432.649	-0.080	7	432.649	0.080
8	441.168	-0.080	8	441.168	0.080
9	467.553	-0.064	9	467.553	0.064
10	574.318	-0.064	10	574.318	0.064
11	589.948	-0.030	11	617.448	-0.030
12	673.566	-0.030	12	701.066	-0.030
13	701.066	0.030	13	744.769	-0.080
14	744.769	0.080	14	751.595	-0.080
15	751.595	0.080	15		

Figure 87 Calculated cross slopes depending on profile of road

Once the problem was found, an attempt to correct the model was carried out. The first step was to try to implement automatically calculated superelevation for FV44. This resulted in many problems such as change of FV44 next to the southern roundabout or next to Strømsbrua. On the figure below - difference of levels, FV44 is higher than Strømsbrua by 60cm.

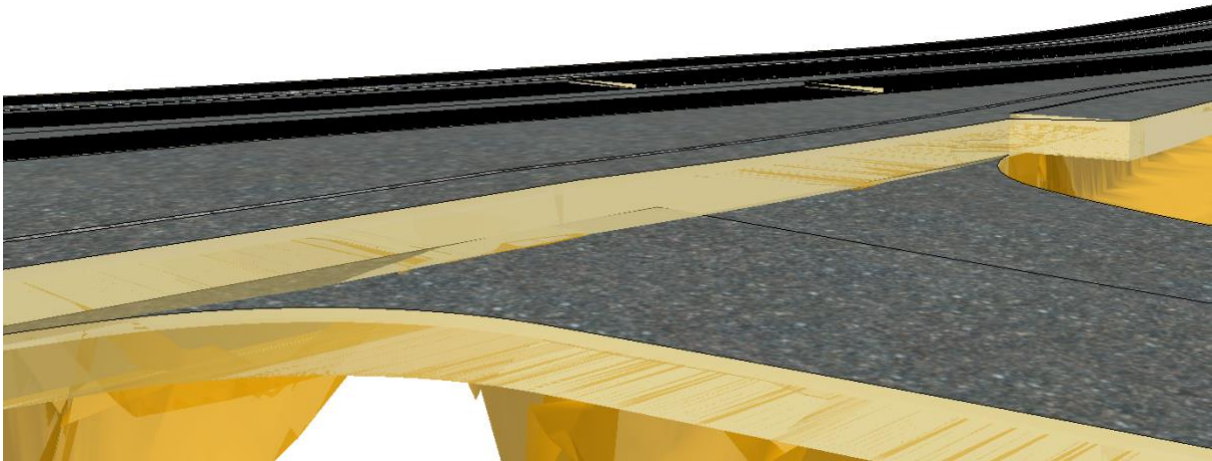

Figure 88 Difference of levels when superelevation implemented for FV44, view from Strømsbrua

One solution is to change the vertical alignment of Strømsbrua and/or FV44 but that is not possible since roads need to follow existing terrain as much as possible. Changing elevation of roads to delete such a huge difference will impact a big section of roads. This reason along with no regulations from Statens Vegvesen and high horizontal radius and small change of elevations of FV44 results that in the end superelevation was not applied in the project and cross fall is the same for the whole road.

5. Conclusion

During this project different aspects concerning Bussveien in Stavanger were analyzed, starting with introduction to the Bussveien project, project area and research questions. Secondly, detailed principles of Bussveien were demonstrated – physically separated bus lanes, signal-controlled intersections where buses are prioritized and infrastructure for pedestrians and cyclists is implemented.

Next part aims to answer RQ1: *How do express bus lanes help in urban transportation?* Firstly, the chapter defines Bus Rapid Transit (BRT) systems as an efficient and economical public transportation alternative to rail and metro systems which consists of dedicated bus lanes. Other key features are well-structured transit hubs, infrastructure for pedestrians and cyclists, and low-floor buses with GPS tracking that ensure timely and reliable service. Furthermore, the implementation of BRT could create a 'snowball effect', where increased usage leads to more investment in the system leading to a bigger network and more departures and more people using it. Finally, the chapter highlights the importance of climate-adapted transit hubs and buses to ensure BRT usage regardless of weather conditions.

In conclusion, integration of a well-planned BRT system can significantly enhance urban quality of life by reducing pollution and improving public transport reliability.

Next part provides an answer for RQ2: *How will the new bus road impact walking time to bus stops?*

Since for the new proposal bus stops layout is changed and presented studies show that proximity to bus stops impacts ridership, analysis in QGIS was done for existing and new situation.

Although analysis found that the difference is considerable for 5min walking distance (reduction of covered area by 45%), there are some limitations to that. The first one is precision of used software – some isochrones areas do not make sense. The second is that significant reduction of covered area does not necessarily impose an impact on a significant number of residents in the project area. A future study of urban density in the area could provide a more comprehensive analysis to show how severe of an impact the new layout of bus stops has on residents.

Concluding, covered area for 5, 10 and 15min walking time to bus stops will be reduced by corresponding by 45, 18 and 1%, making it longer to reach bus stops from the area.

For the last RQ3: *To what extent does utilization of Novapoint affect the planning process in public administration, and what is the level of accessibility for novice users?*, two steps were done.

The first one was to collect testimonies from road planners in Rogaland County to find out that their opinions on use and utility of Novapoint are slightly positive. Simultaneously, some opinions on problems and issues in Novapoint point to the fact that errors are prevailing, and software could be programmed in an easier way, especially for novice users. Then, a 3D model in Novapoint was constructed by a novice user – author – to verify and validate testimonies. The process of construction started from the collection of SOSI and dwg files, which were used to construct base for further work. Then construction of 3D model of FV44 and connecting intersections were done by using road tasks based on line tasks resulting in simply 3D model of roads without desired shapes. Then road surfaces were edited using newly constructed boundary lines depending on road profiles, resulting in a ready 3D model.

The whole process allowed, not only to learn software by author, which can be used in his future professional carrier, but mainly, to verify that the software is lacking intuitiveness, often crashes and is not intuitive for an inexperienced user.

Concluding, based on testimonies Novapoint improves slightly projects efficiency, accuracy and quality. Construction of the 3D model and issues associated with it, showed that Novapoint has moderate level of accessibility for novice user.

This project analyzed various aspects of the Bussveien in Stavanger, focusing on the system's layout, impact on urban transportation, and effect on walking times to bus stops. It revealed that the Bus Rapid Transit (BRT) system offers an efficient, reliable and cost-effective alternative to traditional public transportation. Changes to the bus stop layout increase walking times from the area. In terms of software utilization, the study found Novapoint to slightly increase overall utility in planning process in public administration and to be moderately accessible for novice users, due to its lack of intuitiveness.

6. References

Bymiljøpakken. (2022). *Handlingsprogram 2023-2026*. Retrieved from <https://bymiljopakken.no/om-oss/#prosjektene>

Rogaland Fylkeskommune. (2023). *Map with status of sections. (Kart med status delstrekninger)*. Retrieved from <https://www.rogfk.no/vare-tjenester/vei-og-kollektivtransport/bussveien/kart-med-status-delstrekninger/>

Norgeskart. (n.d.) *Location of the project area on map of south Norway and Stavanger area*. Retrieved from: <https://norgeskart.no/#!?project=norgeskart&layers=1003&zoom=9&lat=6572933.89&lon=-31809.71>

Kolumbus. (2019). Kolumbus.no. Retrieved from: <https://www.kolumbus.no/>

Statens Vegvesen. (2022). *N-V123 Kollektivveiledning - Utforming av kollektivanlegg på veg og gate*. Retrieved from: <https://viewers.vegnorm.vegvesen.no/product/859948?filePath=bb898720-0316-44e4-bfbb-233aec91292e.pdf>

Chapman, L. (2007). Transport and climate change: a review. *Journal of Transport Geography*, 15(5), 354-367. DOI: <https://doi.org/10.1016/j.jtrangeo.2006.11.008>

Guerra, E., Cervero, R., & Tischler, D. (2012). The half-mile circle: Does it best represent transit station catchments? *Transportation Research Record*, 2276(1), 101-109. Retrieved from: https://www.researchgate.net/publication/254397223_The_Half-Mile_Circle_Does_It_Represent_Transit_Station_Catchments

Besser, L. M., & Dannenberg, A. L. (2005). Walking to public transit: steps to help meet physical activity recommendations. *American journal of preventive medicine*, 29(4), 273–280. <https://doi.org/10.1016/j.amepre.2005.06.010>

Lachapelle, U., Frank, L., Saelens, B. E., Sallis, J. F., & Conway, T. L. (2011). Commuting by public transit and physical activity: where you live, where you work, and how you get there. *Journal of physical activity & health*, 8 Suppl 1, S72–S82. <https://doi.org/10.1123/jpah.8.s1.s72>

MacDonald, J. M., Stokes, R. J., Cohen, D. A., Kofner, A., & Ridgeway, G. K. (2010). The effect of light rail transit on body mass index and physical activity. *American journal of preventive medicine*, 39(2), 105–112. <https://doi.org/10.1016/j.amepre.2010.03.016>

Hole, A. (2021) How do people travel in the space by Strømsbrua that is closely connected to the public transport? Retrieved from: <https://uis.brage.unit.no/uis-xmlui/handle/11250/2774484>

Cervero, R. (2013). Bus rapid transit (BRT): An efficient and competitive mode of public transport. Berkeley, CA: Institute of Urban and Regional Development. Retrieved from: <https://escholarship.org/uc/item/4sn2f5wc>

Hidalgo, D. and Yepes, T. (2005). Are Bus Rapid Transit Systems Effective in Poverty Reduction? Experience of Bogotá's TransMilenio and Lessons For Other Cities. Retrieved from: https://www.researchgate.net/publication/318751110_Are_Bus_Rapid_Transit_Systems_Effective_in_Poverty_Reduction_Experience_of_Bogota's_TransMilenio_and_Lessons_For_Other_Cities

Yazici, M., Levinson, H., Ilicali, M., Camkesen, N., Kamga, C. 2013. A bus rapid transit line case study: Istanbul's Metrobus system. *Journal of Public Transportation*, Vol. 16, No. 1, pp. 153-177. DOI: [10.5038/2375-0901.16.1.8](https://doi.org/10.5038/2375-0901.16.1.8)

Daniels, S., Brijs, T., Nuyts, E., & Wets, G. (2009). Injury crashes with bicyclists at roundabouts: influence of some location characteristics and the design of cycle facilities. *Journal of Safety Research*, 40(2), 141-148. DOI: <https://doi.org/10.1016/j.jsr.2009.02.004>

Dill, J., & Monsere, C. M. (2012). Evaluation of bike boxes at signalized intersections. *Accident Analysis & Prevention*, 44(1), 126-134. DOI: <https://doi.org/10.1016/j.aap.2010.10.030>

Cervero, R., & Kang, C. D. (2011). Bus rapid transit impacts on land uses and land values in Seoul, Korea. *Transport Policy*, 18(1), 102-116. DOI: <https://doi.org/10.1016/j.tranpol.2010.06.005>

Cain, A., Darido, G. B., Baltés, M. R., Rodríguez, P. and Barrios, J. (2007) Applicability of TransMilenio

bus rapid transit system of Bogota, Colombia, to the United States, *Transportation Research Record*,

2034, pp. 45–54. Retrieved from: <https://www.semanticscholar.org/paper/Applicability-of-Bogot%C3%A1%E2%80%99s-TransMilenio-BRT-System-Cain-Darido/1a56a9b779bb00fdc7374fe59ba07af233f13f37>

Hidalgo, D. and Graftieaux, P. (2008) Bus rapid transit systems in Latin America and Asia results and

difficulties in 11 cities, *Transportation Research Record*, 2072, pp. 77–88. Retrieved from: https://www.researchgate.net/publication/245562965_Bus_Rapid_Transit_Systems_in_Latin_America_and_Asia_Results_and_Difficulties_in_11_Cities

Seglem, E. (2011, July) GPS-sproring av bussene ett år unna. *Stavanger Aftenblad*. Retrieved from: <https://www.aftenbladet.no/lokalt/i/e6AOI/gps-sproring-av-bussene-ett-aar-unna>

Wright, L., Hook, W., (2007). *Bus Rapid Transit Planning Guide*. Institute for Transportation & Development Policy, New York. Retrieved from: https://nacto.org/docs/usdg/brt_guide_itdp.pdf

Levinson, H., Zimmerman, S., Clinger, J., Rutherford, S., RL, S., Cracknell, J., Soberman, R., (2003). *Bus Rapid Transit*. (TCRP Report 90. T. C. R. Program, Transportation Research Board, Washington, DC). Retrieved from: https://nacto.org/docs/usdg/tcrp_rpt_90_case_studies_volume_1_levinson.pdf

Pulugurtha, S., Mishra, R., Jayanthi, S. (2022). Does Transit Service Reliability Influence Ridership? Mineta Transportation Institute Publications. <https://doi.org/10.31979/mti.2022.2118>

Cervero, R., & Duncan, M. (2002). Benefits of proximity to rail on housing markets: Experiences in Santa Clara County. *Journal of Public Transportation*, 5(1), 1-18. Retrieved from: <https://www.sciencedirect.com/science/article/pii/S1077291X22004209>

Rodriguez, D. A., & Targa, F. (2004). Value of accessibility to Bogotá's bus rapid transit system. *Transport Reviews*, 24(5), 587-610 Retrieved from: https://www.researchgate.net/publication/233578561_Value_of_accessibility_to_Bogota%27s_bus_rapid_transit_system

Martínez, L. M., & Viegas, J. M. (2013). Effects of transportation accessibility on residential property values: Hedonic price model in the Lisbon, Portugal, metropolitan area.

Transportation Research Record, 2344(1), 56-63. Retrieved from: https://www.researchgate.net/publication/254609302_Effects_of_Transportation_Accessibility_on_Residential_Property_Values_Hedonic_Price_Model_in_Lisbon_Portugal_Metropolitan_Area

The World Bank. (2022). Urban Development. Retrieved from <https://www.worldbank.org/en/topic/urbandevelopment/overview>

Litman, T. (2023). Evaluating public transit benefits and costs: Best practices guidebook. *Victoria Transport Policy Institute*. Retrieved from: <https://www.vtpi.org/tranben.pdf>

Mahajan, P. (2021). 10 Reasons Why 3D Modeling is Important in the Construction Industry. Retrieved from: <https://www.selfcad.com/blog/10-reasons-why-3d-modeling-is-important-in-the-construction-industry>

Stavanger Aftenblad. (2020, December 7). Hva skal skje på sykehustomta på Våland? *Stavanger Aftenblad*. Retrieved from: <https://www.aftenbladet.no/lokalt/i/0KKOx6/hva-skal-skje-paa-sykehustomta-paa-vaaland>

CDC. (2022). Assessing Your Weight. Retrieved from: <https://www.cdc.gov/healthyweight/assessing/index.html>

Tang, L., & Thakuria, P. (2012). Ridership effects of real-time bus information system: A case study in the City of Chicago. *Transportation Research Part C: Emerging Technologies*, 22, 146-161. Retrieved from: https://www.alaskapublic.org/wp-content/uploads/2012/06/bis_transit_chicago.pdf

Frank, L. D., Andresen, M. A., & Schmid, T. L. (2004). Obesity relationships with community design, physical activity, and time spent in cars. *American journal of preventive medicine*, 27(2), 87–96. <https://doi.org/10.1016/j.amepre.2004.04.011>

Spinney, J. E., & Millward, H. (2011). Weather impacts on leisure activities in Halifax, Nova Scotia. *International journal of biometeorology*, 55(2), 133–145. <https://doi.org/10.1007/s00484-010-0319-z>

Hofmann, M., & O'Mahony, M. (2005). The impact of adverse weather conditions on urban bus performance measures. In *Proceedings of the 2005 IEEE Intelligent Transportation Systems Conference* (pp. 128-133). <https://doi:10.1109/ITSC.2005.1520087>

Tang, L., & Thakuria, P. (2012). Ridership effects of real-time bus information system: A case study in the City of Chicago. *Transportation Research Part C: Emerging Technologies*, 22, 146-161. <https://doi:10.1016/j.trc.2012.01.001>

Sabir, M. (2011). Weather and travel behaviour. Amsterdam: VU University. Retrieved from: <https://research.vu.nl/ws/portalfiles/portal/42203407/complete+dissertation.pdf>

Böcker, L., Dijst, M., & Prillwitz, J. (2013). Impact of everyday weather on individual daily travel behaviours in perspective: A literature review. *Transport Reviews*, 33(1), 71-91. <https://doi:10.1080/01441647.2012.747114>

Soczówka, P., Kłós, M.J., Żochowska, R., Sobota, A. An analysis of the influence of travel time on access time in public transport. *Scientific Journal of Silesian University of Technology. Series Transport*. 2021, 111, 137-149. ISSN: 0209-3324. DOI: <https://doi.org/10.20858/sjsutst.2021.111.12>.

Rogaland fylkeskommune. (2022). *Forprosjekt: Bussveien Hillevåg – Stavanger sentrum*. Not available online.

Munkvik, C. (2016, January 22). *Her åpnes Rogalands første rene bussvei*. Aftenbladet. Retrieved from <https://www.aftenbladet.no/lokalt/i/AXXAn/her-aapnes-rogalands-foerste-rene-bussvei>

Jack, R. (2022, July 1). *Bussveien – Europe's longest BRT system*. Passenger Transport. Retrieved from <https://www.passengertransport.co.uk/2022/07/bussveien-europes-longest-brt-system/>

Handlingsrom. (2018). Handlingsrom. Sak til styringsgruppen for Bypakke Nord-Jæren 8. mars. Retrieved from: <https://bymiljopakken.no/wp-content/uploads/2018/03/VEDLEGG-8-Handlingsrom-Bussveien.pdf>

Institute for Transportation & Development Policy. (N.D.). Retrieved from: <https://www.itdp.org/>

Regjeringen. (2023). *Nullvisjonen*. Retrieved from: https://www.regjeringen.no/no/tema/transport-og-kommunikasjon/veg_og_vegtrafikk/trafikksikkerhet/nullvisjonen/id2966061/

Sanders, R., L. (2015). *Perceived traffic risk for cyclists: The impact of near miss and collision experiences*. Accident Analysis & Prevention P.26-34.
<https://doi.org/10.1016/j.aap.2014.11.004>

Our World in Data. (2023). *Imported or exported CO₂ emissions per capita*. Retrieved from:
https://ourworldindata.org/grapher/imported-or-exported-co-emissions-per-capita?time=1994..latest&country=USA~GBR~OWID_EU27~CHN~IND~BGD~ZAF~NOR~KGZ~KWT~KAZ~ARE~TTO~QAT~BRN~BHR

Bertaud, A. (2004). The spatial organization of cities: Deliberate outcome or unforeseen consequence?. *World Development Report 2003: Dynamic Development in a Sustainable World Background Paper*. Retrieved from: <https://escholarship.org/uc/item/5vb4w9wb>

Novapoint & Quadri (n.d.) Novapoint & Quadri YouTube channel Retrieved from:
<https://www.youtube.com/@NovapointQuadri>



FACULTY OF SCIENCE AND TECHNOLOGY

MASTER'S THESIS

Study programme: City and Regional Planning	The spring semester, 2023 Open / Confidential
Author: Łukasz Bartłomiejczyk	
Supervisor at UiS: Cristian Tosa Co-supervisor: Ari Krisna Mawira Tarigan External supervisor(s): Katrine Skare Bakka	
Thesis title: Bussveien between Hillevåg and Musegata in Stavanger, Norway	
Credits (ECTS): 30	
Keywords: Bussveien, FV44, BRT, 3D model, walking time analysis, Stavanger, stakeholder engagement	Pages: 93 + appendix: 98 Stavanger, 12.06.2023

Table of Contents

FACULTY OF SCIENCE AND TECHNOLOGY.....	1
MASTER'S THESIS.....	1
1. FV sør.....	11
1.1. Horizontal alignment.....	13
1.2. Vertical alignment	13
1.3. Vegoverflater Road surfaces	15
1.3.1. Left side	16
1.3.2. Right side	17
2. Hillevågstunnelen (Ht.).....	20
2.1. Horizontal geometry	21
2.2. Vertical geometry	22
2.3. Vegoverflater.....	23
2.3.1. Left side	23
2.3.2. Right side	24
3. Rundkjøringen, sør, sentraløya (Rss.).....	26
3.1. Horizontal geometry	27
3.2. Vertical geometry	28
3.3. Vegoverflater.....	29
3.3.1. Left side	29
3.3.2. Right side	30
4. Rundkjøringen sør øst sykkel og fortau (Rsø.).....	32
4.1. Horizontal geometry	33
4.2. Vertical geometry	34
4.3. Vegoverflater.....	35
4.3.1. Left side	35
4.3.2. Right side	35
5. Rundkjøringen utvidelse fv44 til tunnelen	37
5.1. Horizontal geometry	37
5.2. Vertical geometry	38
6. Rundkjøringen utvidelse tunnelen til fv44 sør	39
6.1. Horizontal geometry	39
6.2. Vertical geometry	40
7. FV44.....	41
7.1. Horizontal geometry	45
7.2. Vertical geometry	47

7.3.	Vegoverflater.....	49
7.3.1.	Left side	50
7.3.2.	Right side	52
8.	Strømsbrua (brua)	55
8.1.	Horizontal geometry	56
8.2.	Vertical geometry	57
8.3.	Vegoverflater.....	58
8.3.1.	Left side	58
8.3.2.	Right side	58
9.	Strømsbrua in fortau (Sif).....	59
9.1.	Horizontal geometry	60
9.2.	Vertical geometry	61
9.3.	Vegoverflater.....	62
9.3.1.	Left side	62
9.3.2.	Right side	62
10.	Strømsbrua ut fortau (Suf.)	63
10.1.	Horizontal geometry.....	64
10.2.	Vertical geometry	65
10.3.	Vegoverflater.....	66
10.3.1.	Left side	66
10.3.2.	Right side	67
11.	Strømsbrua trafikkøya (St.)	67
11.1.	Horizontal geometry”	68
11.2.	Vertical geometry	69
11.3.	Vegoverflater.....	70
11.3.1.	Left side	70
11.3.2.	Right side	70
12.	Skjærebergveien (Skj.).....	71
12.1.	Horizontal geometry”	72
12.2.	Vertical geometry	73
12.3.	Vegoverflater.....	74
12.3.1.	Left side	74
12.3.2.	Right side	74
13.	Skjærebergveien in.....	77
13.1.	Horizontal geometry.....	77
13.2.	Vertical geometry	78

14.	Skjærebergveien ut	79
14.1.	Horizontal geometry.....	79
14.2.	Vertical geometry	80
15.	Høylandsgata (Høy.)	81
15.1.	Horizontal geometry.....	82
15.2.	Vertical geometry	83
15.3.	Vegoverflater	84
15.3.1.	Left side	84
15.3.2.	Right side	85
16.	Rundkjøringen north, right (Rnr.).....	87
16.1.	Horizontal geometry.....	89
16.2.	Vertical geometry	90
16.3.	Vegoverflater	91
16.3.1.	Left side	91
16.3.2.	Right side	91
17.	Rundkjøringen north, left (Rnl.)	93
17.1.	Horizontal geometry.....	95
17.2.	Vertical geometry	96
17.3.	Vegoverflater	97
17.3.1.	Left side	97
17.3.2.	Right side	98

Table of figures

Figur 1 FV44 sør (view from south)	11
Figur 2 FV44 sør (view from top).....	12
Figur 3 Horizontal alignment, FV44 sør	13
Figur 4 Horizontal alignment, input data, FV44 sør	13
Figur 5 Vertical alignment FV44 sør	14
Figur 6 List of all surfaces for FV44 sør.....	15
Figur 7 Boundary, left, FV44 sør	16
Figur 8 Kjørefelt 1 left, FV44 sør.....	16
Figur 9 Skulder 1, left, FV44 sør.....	16
Figur 10 Kantsteinsvis 1, left, FV44 sør.....	16
Figur 11 Kantsteinsflate 1, left, FV44 sør	16
Figur 12 Kantsteinsvis 2, left, FV44 sør.....	16
Figur 13 Skulder 2, left, FV44 sør	16
Figur 14 Kjørefelt 2, left, FV44 sør.....	17
Figur 15 Skulder 3, left, FV44 sør	17
Figur 16 Sykkelfelt, left, FV44 sør.....	17
Figur 17 Kantsteinsvis 3, left, FV44 sør.....	17
Figur 18 Kantsteinsflate 2, left, FV44 sør	17
Figur 19 Fortau, left, FV44 sør	17
Figur 20 Boundary, right, FV44 sør.....	17
Figur 21 Kjørefelt 1, right, FV44 sør.....	17
Figur 22 Skulder 1, right, FV44 sør	18
Figur 23 Kantsteinsvis 1, right, FV44 sør	18
Figur 24 Kantsteinsflate 1, right, FV44 sør	18
Figur 25 Kantsteinsvis 2, right, FV44 sør	18
Figur 26 Skulder 2, right, FV44 sør	18
Figur 27 Kjørefelt 2, right, FV44 sør.....	18
Figur 28 Skulder 3, right, FV44 sør	18
Figur 29 Sykkelfelt, right, FV44 sør.....	18
Figur 30 Kantsteinsvis 3, right, FV44 sør	19
Figur 31 Kantsteinsflate 2, right, FV44 sør	19
Figur 32 Fortau, right, FV44 sør.....	19
Figur 33 Hillevågstunnelen (view from south)	20
Figur 34 Hillevågstunnelen (view from top).....	20
Figur 35 Horizontal geometry, Hillevågstunnelen.....	21
Figur 36 Horizontal alignment, input data, Hillevågstunnelen	21
Figur 37 Vertical alignment, Hillevågstunnelen	22
Figur 38 List of all surfaces for Hillevågstunnelen.....	23
Figur 39 Boundary, left, Ht.	23
Figur 40 Kjørefelt 1, left, Ht.	24
Figur 41 Skulder, left, Ht.....	24
Figur 42 Kjørefelt, left, Ht.	24
Figur 43 Skulder 2, left, Ht.....	24
Figur 44 Kantsteinsvis 1, left, Ht.....	24
Figur 45 Kantsteinsflate 1, left, Ht.....	24
Figur 46 Boundary, right, Ht.	24
Figur 47 Kjørefelt 1, right, Ht.....	24

Figur 48 Skulder, right, Ht.....	25
Figur 49 Kjørefelt 2, right, Ht.....	25
Figur 50 Skulder 2, right, Ht.....	25
Figur 51 Kantsteinsvis 1, right, Ht.....	25
Figur 52 Kantsteinsflate 1, right, Ht.....	25
Figur 53 Rund. sør sentraøya (view from south).....	26
Figur 54 Rund. sør sentraløya (view from top)	27
Figur 55 Horizontal alignment, input data, Rundkjøring sør sentraløya	27
Figur 56 Vertical alignment, rundkjøring sør sentraløya.....	28
Figur 57 List of all surfaces for Rundkjøringen sør sentraløya	29
Figur 58 Boundary, left, Rss.....	29
Figur 59 Kantsteinsvis 1, left, Rss.	29
Figur 60 Kantsteinsflate 1, left, Rss.	29
Figur 61 Kantsteinsvis 2, left, Rss.	29
Figur 62 Kantsteinsflate 2, left, Rss.	30
Figur 63 Boundary, right, Rss.....	30
Figur 64 Skulder 1, right, Rss.	30
Figur 65 Kjørefelt 1, right, Rss.	30
Figur 66 Skulder 2, right, Rss.	30
Figur 67 Kjørefelt 2, right, Rss.	30
Figur 68 Skulder 3, right, Rss.	31
Figur 69 Kantsteinsvis 1, right, Rss.	31
Figur 70 Kantsteinsflate 1, right, Rss.	31
Figur 71 Rund. sør øst sykkel og fortau (view from south)	32
Figur 72 Rund. sør øst sykkel og fortau (view from top).....	33
Figur 73 Horizontal alignment, input data, Rund. utvidelse fra sør til nord FV44	33
Figur 74 Vertical alignment, rund. utvidelse fra sør til nord fv44	34
Figur 75 List of all surfaces for rund. sør øst sykkel og fortau.....	35
Figur 76 Boundary, left, Rsø.	35
Figur 77 Boundary, right, Rsø.	35
Figur 78 Skulder 1, right, Rsø.....	35
Figur 79 Skulder 2, right, Rsø.....	35
Figur 80 Sykkelfelt, right, Rsø.	36
Figur 81 Skulder 3, right, Rsø.....	36
Figur 82 Kantsteinsvis 1, right, Rsø.....	36
Figur 83 Kantsteinsflate 1, right, Rsø.....	36
Figur 84 Fortau, right, Rsø.	36
Figur 85 Horizontal alignment, rund. utvidelse fv44 til tunnelen	37
Figur 86 Horizontal alignment, input data, rund. utvidelse fv44 til tunnelen.....	37
Figur 87 Vertical alignment, rundkjøringen utvidelse fv44 til tunnelen	38
Figur 88 Horizontal alignment, rundkjøringen utvidelse tunnelen til fv44 sør	39
Figur 89 Horizontal alignment, input data, rundkjøringen utvidelse tunnelen til fv44 sør	39
Figur 90 Vertical alignment, rundkjøringen utvidelse tunnelen til fv44 sør	40
Figur 91 FV44 until T intersection (view from south).....	41
Figur 92 FV44 from T intersection (view from south)	42
Figur 93 FV44 to T intersection (view from top)	43
Figur 94 FV44 from T intersection (view from top).....	44
Figur 95 Horizontal alignment FV44 to T-intersection	45

Figur 96 Horizontal alignment FV44 from T-intersection.....	46
Figur 97 Horizontal alignment, input data, FV44	47
Figur 98 All surfaces for FV44.....	49
Figur 99 Boundary, left, FV44.....	50
Figur 100 Kolektivfelt, left, FV44	50
Figur 101 Skulder 1, left, FV44	50
Figur 102 Kantsteinsvis 1, left, FV44	50
Figur 103 Kantsteinsflate 1, left, FV44	50
Figur 104 Kantsteinsvis 2, left, FV44	51
Figur 105 Skulder 2, left, FV44	51
Figur 106 Kjørefelt 1, left, FV44.....	51
Figur 107 Skulder 3, left, FV44	51
Figur 108 Kjørefelt 2, left, FV44.....	51
Figur 109 Skulder 4, left, FV44	51
Figur 110 Sykkelfelt, left, FV44.....	51
Figur 111 Kantsteinsvis 3, left, FV44	52
Figur 112 Kantsteinsflate 2, left, FV44	52
Figur 113 Fortau, left, FV44.....	52
Figur 114 Boundary, right, FV44.....	52
Figur 115 Kolektivfelt, right, FV44.....	52
Figur 116 Skulder 1, right, FV44	52
Figur 117 Kantsteinsvis 1, right, FV44	53
Figur 118 Kantsteinsflate 1, right, FV44	53
Figur 119 Kantsteinsvis 2, right, FV44	53
Figur 120 Skulder 2, right, FV44	53
Figur 121 Kjørefelt 1, right, FV44	54
Figur 122 Skulder 3, right, FV44	54
Figur 123 Sykkelfelt, right, FV44.....	54
Figur 124 Kantsteinsvis 3, right, FV44	54
Figur 125 Kantsteinsflate 2, right, FV44	54
Figur 126 Fortau, right, FV44.....	54
Figur 127 Strømsbrua (view from south)	55
Figur 128 Strømsbrua (view from top).....	55
Figur 129 Horizontal alignment, Strømsbrua	56
Figur 130 horizontal alignment, input data, Strømsbrua	56
Figur 131 Vertical alignment, Strømsbrua	57
Figur 132 All layer for Strømsbrua	58
Figur 133 Boundary, left, brua	58
Figur 134 Kjørefelt 1, left, brua	58
Figur 135 Boundary, right, brua	58
Figur 136 Kjørefelt 1, right, brua	59
Figur 137 Strømsbrua in fortau (view from south)	59
Figur 138 Strømsbrua in fortau (view from top).....	60
Figur 139 Horizontal alignment, Strømsbrua in	60
Figur 140 Horizontal alignment, input data, Strømsbrua in.....	61
Figur 141 Vertical alignment, avgr. Strømsbrua in.....	61
Figur 142 All surfaces for Strømsbrua in fortau	62
Figur 143 Boundary, left, Sif.....	62

Figur 144 Boundary, right, Sif.....	62
Figur 145 Kjørefelt 1, right, Sif.....	62
Figur 146 Skulder 1, right, Sif.	62
Figur 147 Kantsteinsvis 1, right, Sif.	63
Figur 148 Kantsteinsflate 1, right, Sif.	63
Figur 149 Fortau, right, Sif.....	63
Figur 150 Strømsbrua ut fortau (view from south).....	63
Figur 151 Strømsbrua ut fortau (view from top).....	63
Figur 152 Horizontal alignment, Strømsbrua ut.....	64
Figur 153 Horizontal alignment, input data, Strømsbrua ut	64
Figur 154 Vertical alignment, Strømsbrua ut	65
Figur 155 All surfaces of Strømsbrua ut fortau	66
Figur 156 Boundary, left, Suf.....	66
Figur 157 Kjørefelt 1, left, Suf.....	66
Figur 158 Skulder 1, left, Suf.	66
Figur 159 Kantsteinsvis 1, left, Suf.	66
Figur 160 Kantsteinsflate 1, left, Suf.	66
Figur 161 Fortau, left, Suf.....	67
Figur 162 Boundary, right, Suf.....	67
Figur 163 Strømsbrua trafikkøya (view from south)	67
Figur 164 Strømsbrua trafikkøya (view from top)	68
Figur 165 Horizontal alignment, Strømsbrua trafikkøya.....	68
Figur 166 Horizontal alignment, input data, Strømsbrua trafikkøya	69
Figur 167 Vertical alignment, Strømsbrua trafikkøya	69
Figur 168 All surfaces for Strømsbrua trafikkøya.....	70
Figur 169 Boundary, left, St.....	70
Figur 170 Kantsteinsvis 1, left, St.	70
Figur 171 Kantsteinsflate, left, St.	70
Figur 172 Boundary, right, St.....	70
Figur 173 Skjærebergveien (view from south).....	71
Figur 174 Skjærebergveien (view from top).....	71
Figur 175 Horizontal alignment, Skjærebergveien.....	72
Figur 176 Horizontal alignment, input data, Skjærebergveien	72
Figur 177 Vertical alignment, Skjærebergveien	73
Figur 178 All surfaces of Skjærebergveien	74
Figur 179 Boundary, left Skj.	74
Figur 180 Kjørefelt 1, left, Skj.	74
Figur 181 Boundary, right, Skj.	74
Figur 182 Cutting point for right, Skj.	75
Figur 183 Kjørefelt 1, right, Skj.....	75
Figur 184 Crossing of avgr. Skjærebergveien in and avgr. Sykkel høyre.....	76
Figur 185 Horizontal alignment, Skjærebergveien in.....	77
Figur 186 Horizontal alignment, input data, Skjærebergveien	77
Figur 187 Vertical alignment, Skjærebergveien in	78
Figur 188 Horizontal alignment, Skjærebergveien ut	79
Figur 189 Vertical alignment, input data, Skjærebergveien ut	79
Figur 190 Vertical alignment, Skjærebergveien ut.....	80
Figur 191 Høylandsgata (view from south)	81

Figur 192 Høylandsgata (view from top).....	81
Figur 193 Horizontal alignment, Høylandsgata	82
Figur 194 Horizontal alignment, input data, Høylandsgata	82
Figur 195 Vertical alignment, Høylandsgata	83
Figur 196 All surfaces for Høylandsgata	84
Figur 197 Boundary, left, Høy.....	84
Figur 198 Kjørefelt 1, left, Høy.	84
Figur 199 Skulder 1, left, Høy.	84
Figur 200 Kantsteinsvis 1, left, Høy.	85
Figur 201 Kantsteinsflate 1, left, Høy.	85
Figur 202 Fortau, left, Høy.....	85
Figur 203 Boundary, right, Høy.	85
Figur 204 Kjørefelt 1, right, Høy.	85
Figur 205 Skulder 1, right, Høy.	85
Figur 206 Kantsteinsvis 1, right, Høy.	85
Figur 207 Kantsteinsflate 1, right, Høy.	85
Figur 208 Fortau, right, Høy.	86
Figur 209 Rundkjøringen north, right (view from south)	87
Figur 210 Rundkjøringen north, right (view from top).....	88
Figur 211 Horizontal alignment, rund. Nord h. kjørefelt.....	89
Figur 212 Horizontal alignment, input data, rund. nord h. kjørefelt.....	89
Figur 213 Vertical alignment, rund. nord h. kjørefelt.....	90
Figur 214 All surfaces for Rnr.	91
Figur 215 Boundary, left, Rnr.	91
Figur 216 Boundary, right, Rnr.	91
Figur 217 Kjørefelt 1, right, Rnr.	91
Figur 218 Skulder 1, right, Rnr.	92
Figur 219 Sykkelfelt, right, Rnr.	92
Figur 220 Kantsteinsvis 1, right, Rnr.	92
Figur 221 Kantsteinsflate 1, right, Rnr.....	92
Figur 222 Fortau, right, Rnr.	92
Figur 223 Rundkjøringen nord v. kjørefelt (view from south).....	93
Figur 224 Rundkjøringen nord v. kjørefelt (view from top)	94
Figur 225 Horizontal alignment, rund. nord v. kjørefelt	95
Figur 226 Horizontal alignment, input data, rund. nord v. kjørefelt.....	95
Figur 227 Vertical alignment, rund. nord v. kjørefelt.....	96
Figur 228 All surfaces for Rnl.....	97
Figur 229 Boundary, left, Rnl.....	97
Figur 230 Kjørefelt 1, left, Rnl.....	97
Figur 231 Skulder 1, left, Rnl.	97
Figur 232 Kjørefelt 2, left, Rnl.....	98
Figur 233 Kantsteinsvis, left, Rnl.	98
Figur 234 Kantsteinsflate, left, Rnl.	98
Figur 235 Fortau, left, Rnl.....	98
Figur 236 Boundry, left, Rnl.....	98

All pictures are north orientated if not stated other.

1. FV sør

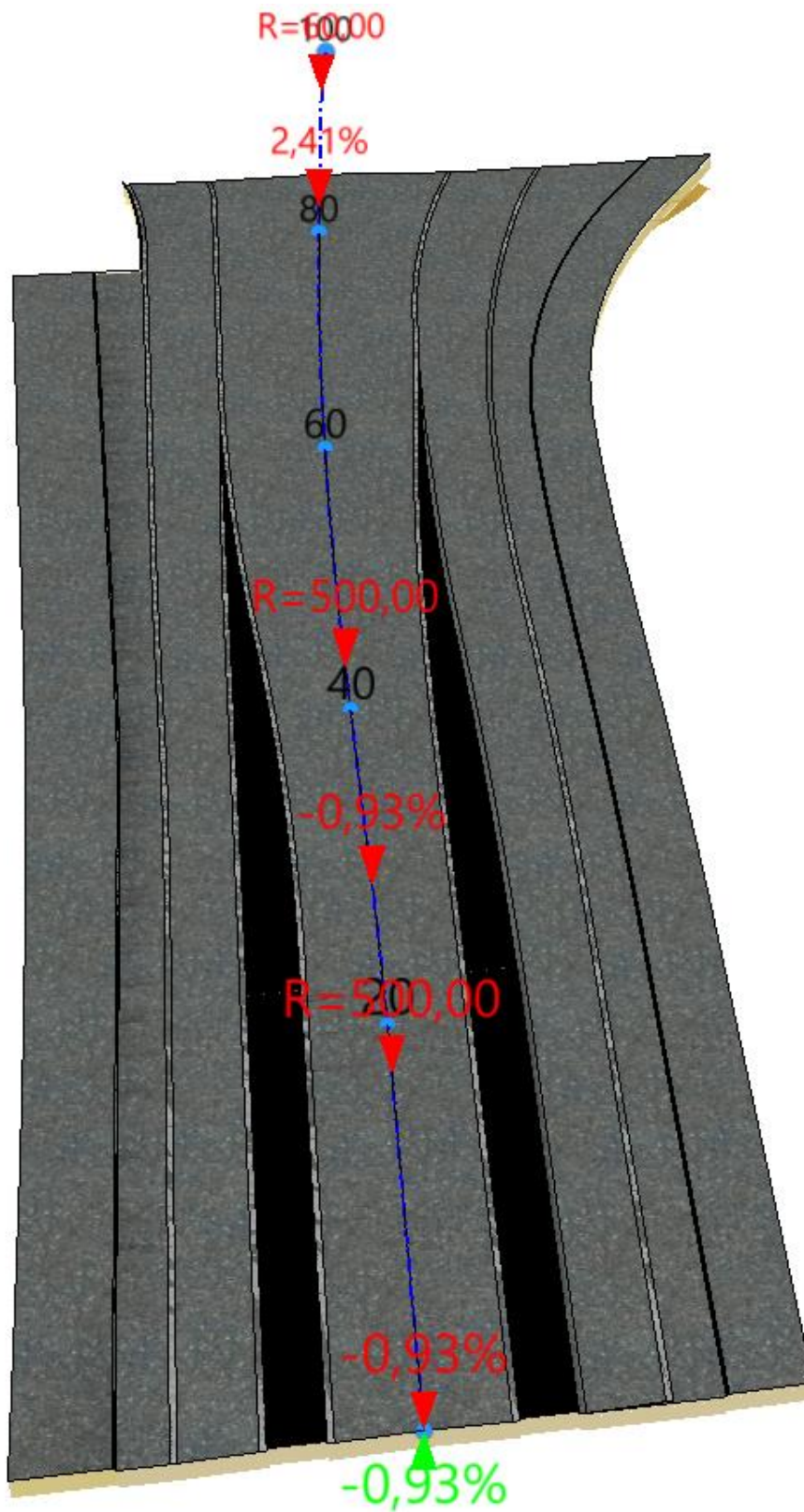

Figur 1 FV44 sør (view from south)

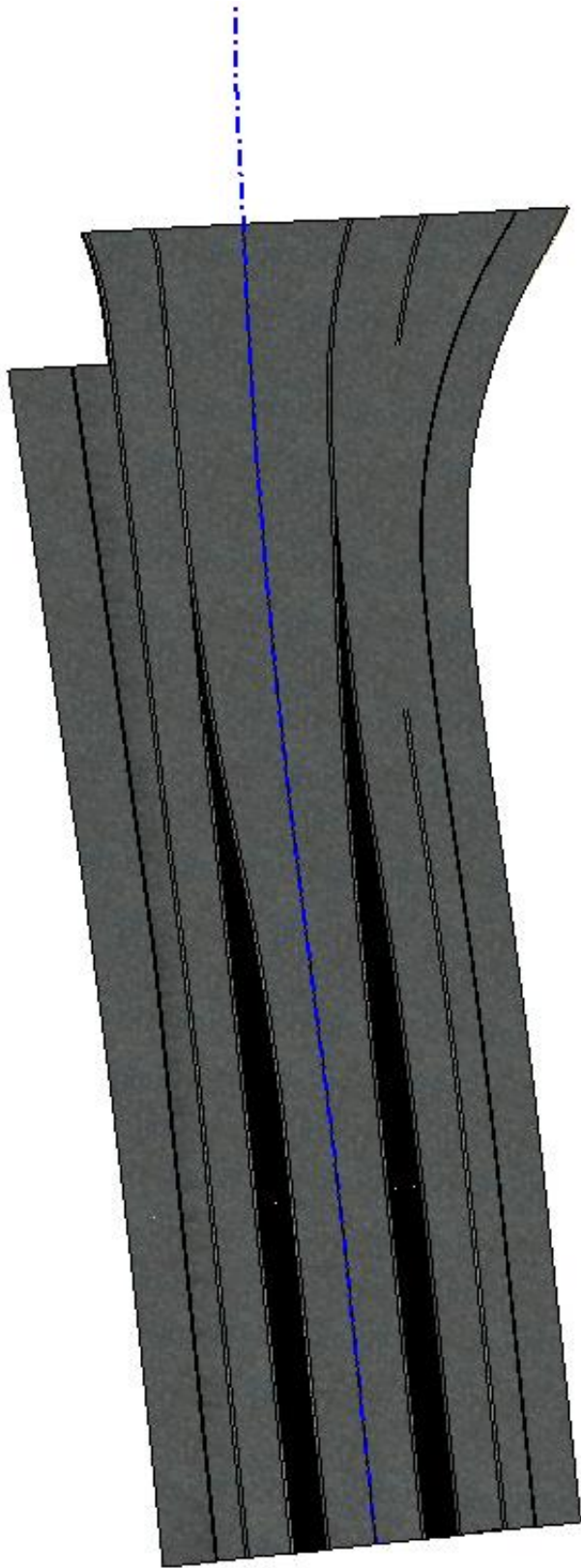

Figur 2 FV44 sør (view from top)

1.1. Horizontal alignment

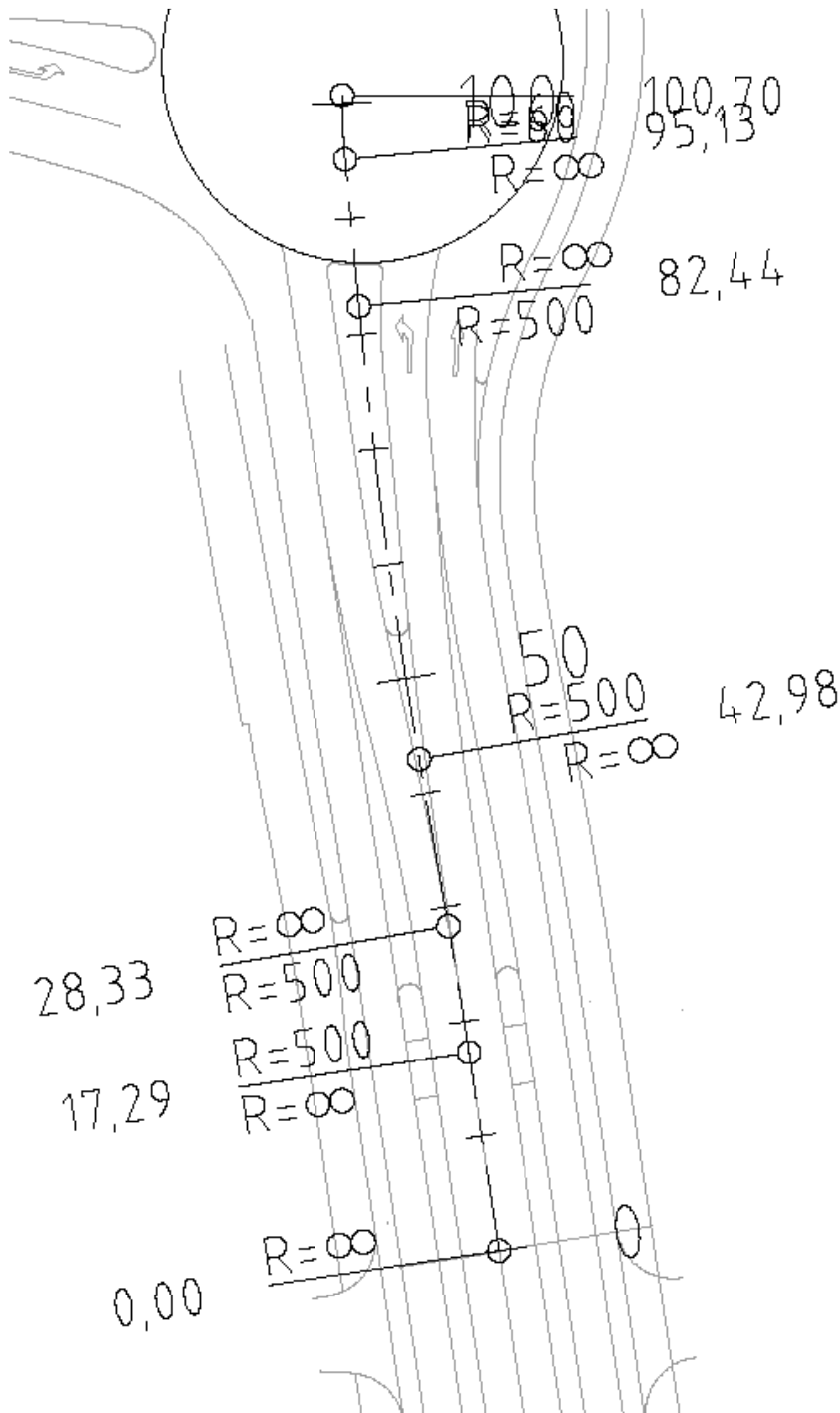

Figur 3 Horizontal alignment, FV44 sør

Nr.	Elementtype	Innspenning	Radius	Lengde	Param.	Retning	Buetype	Øst1	Nord1	Øst2	Nord2
1	Rettlinje	×-×		17.287		1.721		113950.530	1105945.506		1105965.833
2	Sirkelbue	—x	-500.000	11.044			Kort	113944.773	1105981.270		
3	Rettlinje	—x		14.645		0.000		113943.793	1105987.280		
4	Sirkelbue	—x	500.000	39.485			Kort	113938.706	1106024.615		
5	Rettlinje	—x		12.691		0.000		113937.310	1106039.532		
6	Sirkelbue	—x	60.000	5.564			Kort	113937.038	1106045.232		

Figur 4 Horizontal alignment, input data, FV44 sør

1.2. Vertical alignment

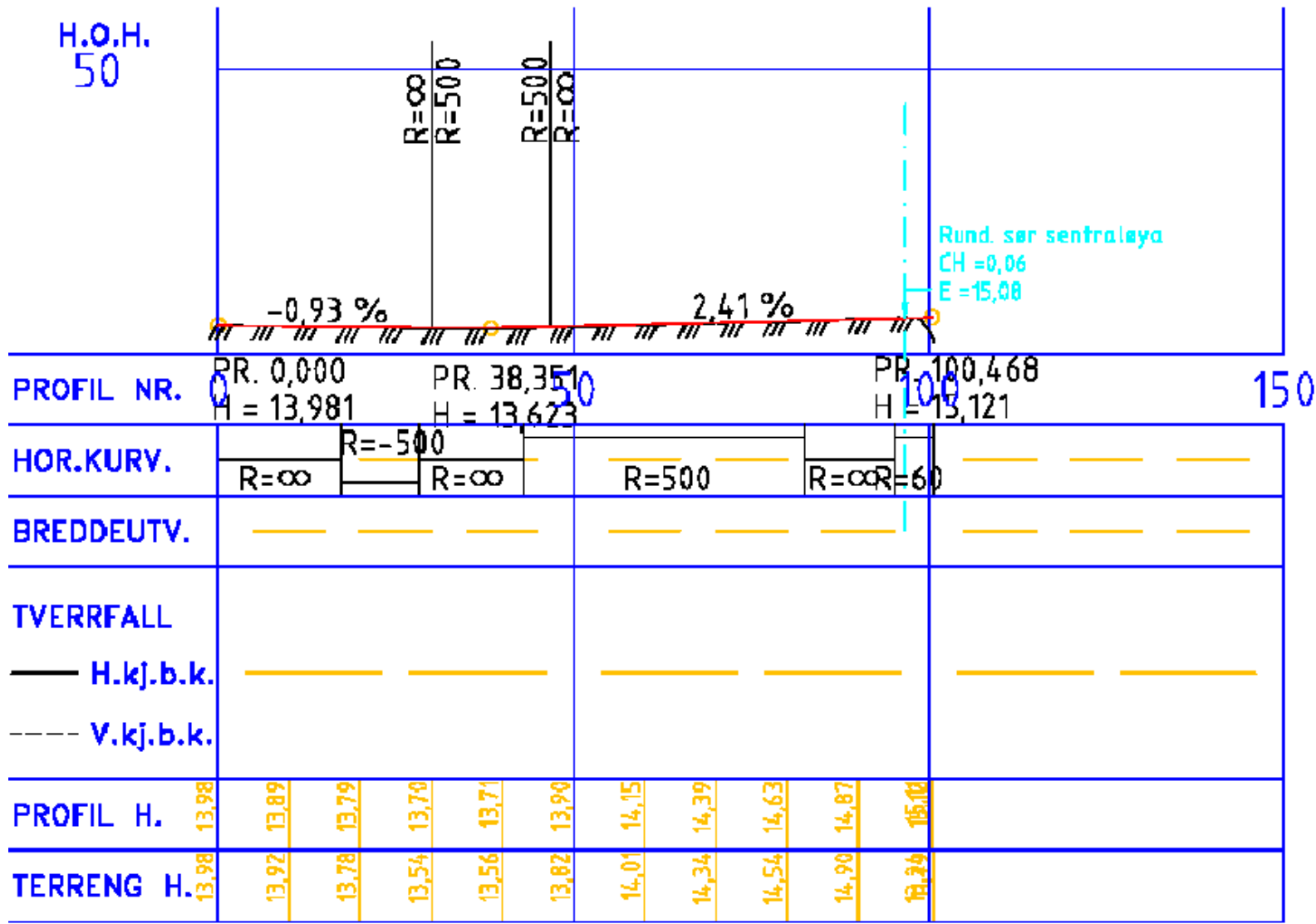

FV44 Sø

Figur 5 Vertical alignment FV44 sø

1.3. Vegoverflater Road surfaces

FV44 Sør	
[-] Venstre side	
-- Avgrensninger	
[-] Kjørebane	... -1.01 V. Kjørefelt 1
[-] Skulder	... -2.01 V. Skulder 1 ... -2.18 V. Kantsteinsvis 1 ... -2.19 V. Kantsteinsflate 1
[-] Tilleggsflater	... -3.01 V.Kantsteinsvis 2 ... -3.02 V.Skulder 2 ... -3.03 V.Kjørefelt 2 ... -3.04 V.Skulder 3 ... -3.05 V.Sykkelfelt ... -3.06 V.Kantsteinsvis 3 ... -3.07 V.Kantsteinsflate 2 ... -3.15 V. Fortau
[-] Grøft	... -4.01 V. Grøft 1 ... -4.02 V. Grøft 2
[-] Fjellskjæring	... -5.11 V. Fjellskj. 11
[-] Jordskjæring	... -6.11 V. Jordskj. 11
[-] Fylling	... -7.11 V. Fylling 11
[-] Høyre side	
-- Avgrensninger	
[-] Kjørebane	... 1.01 H. Kjørefelt 1
[-] Skulder	... 2.01 H. Skulder 1 ... 2.18 H. Kantsteinsvis 1 ... 2.19 H. Kantsteinsflate 1
[-] Tilleggsflater	... 3.01 H.Kantsteinsvis 2 ... 3.02 H.Skulder 2 ... 3.03 H.Kjørefelt 2 ... 3.04 H.Skulder 3 ... 3.05 H.Sykkelfelt ... 3.06 H.Kantsteinsvis 3 ... 3.07 H.Kantsteinsflate 2 ... 3.15 H. Fortau
[-] Grøft	... 4.01 H. Grøft 1 ... 4.02 H. Grøft 2
[-] Fjellskjæring	... 5.11 H. Fjellskj. 11
[-] Jordskjæring	... 6.11 H. Jordskj. 11
[-] Fylling	... 7.11 H. Fylling 11

Figur 6 List of all surfaces for FV44 sør

1.3.1. Left side

	Profil	Flate	Linjeavgrensning	Avstand	Object
1	-9999.000	-3.15 V. Fortau		0.000	
2	77.452	-3.15 V. Fortau		0.000	
3	Brudd				
4	77.452	-3.07 V.Kantsteinsflate		0.000	
5	86.054	-3.07 V.Kantsteinsflate		0.000	
6	Brudd				
7	86.054	Primærlinje		0.000	
8	9999.000	Primærlinje		0.000	

Figur 7 Boundary, left, FV44 sør

	Profil	Bredde	Helling	Metode	Linje	Fri flate
1	-99999.000	3.000	-0.030			
2	-999.000			↙	avgr. venstre kollektiv sk	-1.01 V. Kjørefelt 1
3	79.456			↘	avgr. venstre kollektiv sk	-1.01 V. Kjørefelt 1
4	79.456			↔	avgr.rund. sør FV44 sør	-1.01 V. Kjørefelt 1
5	9999.000			↘	avgr.rund. sør FV44 sør	-1.01 V. Kjørefelt 1
6	99999.000	3.000	-0.030			

Figur 8 Kjørefelt 1 left, FV44 sør

	Profil	Bredde	Helling	Metode	Linje	Fri flate
1	-99999.000	0.250	Arv			
2	99999.000	0.250	Arv			

Figur 9 Skulder 1, left, FV44 sør

	Profil	Bredde	Helling	Metode	Linje	Fri flate
1	-99999.000	0.010	13.000			
2	22.507	0.010	13.000			
3	Brudd					
4	22.507	0.000	13.000			
5	99999.000	0.000	13.000			

Figur 10 Kantsteinsvis 1, left, FV44 sør

	Profil	Bredde	Helling	Metode	Linje	Fri flate
1	-99999.000	0.090	0.000			
2	-99999.000			↙	avgr. kjørebane venstre	-2.19 V. Kantsteinsflate
3	63.558			↘	avgr. kjørebane venstre	-2.19 V. Kantsteinsflate
4	63.558	0.000	0.000			
5	9999.000	0.000	0.000			

Figur 11 Kantsteinsflate 1, left, FV44 sør

	Profil	Bredde	Helling	Metode	Linje	Fri flate
1	-99999.000	0.010	-13.000			
2	22.507	0.010	-13.000			
3	Brudd					
4	22.507	0.000	-13.000			
5	99999.000	0.000	-13.000			

Figur 12 Kantsteinsvis 2, left, FV44 sør

	Profil	Bredde	Helling	Metode	Linje	Fri flate
1	-99999.000	0.250	-0.030			
2	51.286	0.250	-0.030			
3	63.558	0.000	-0.030			
4	99999.000	0.000	-0.030			

Figur 13 Skulder 2, left, FV44 sør

	Profil	Bredde	Helling	Metode	Linje	Fri flate
1	-99999.000	3.000	-0.030			
2	-99999.000			↘	avgr. venstre kjørebane	-3.03 V.Kjørefelt 2
3	79.456			↘	avgr. venstre kjørebane	-3.03 V.Kjørefelt 2
4	79.456			↘	avgr. rund. sør Tunnelen	-3.03 V.Kjørefelt 2
5	91.837			↘	avgr. rund. sør Tunnelen	-3.03 V.Kjørefelt 2
6	99999.000	3.000	-0.030			

Figur 14 Kjørefelt 2, left, FV44 sør

	Profil	Bredde	Helling	Metode	Linje	Fri flate
1	-9999.000	0.250	Arv			
2	9999.000	0.250	Arv			

Figur 15 Skulder 3, left, FV44 sør

	Profil	Bredde	Helling	Metode	Linje	Fri flate
1	-99999.000			↘	avgr. sykkel venstre a	-3.05 V.Sykkelfelt
2	77.452			↘	avgr. sykkel venstre a	-3.05 V.Sykkelfelt
3	77.452	0.000	0.000			
4	9999.000	0.000	0.000			

Figur 16 Sykkelfelt, left, FV44 sør

	Profil	Bredde	Helling	Metode	Linje	Fri flate
1	-99999.000	0.010	13.000			
2	99999.000	0.010	13.000			

Figur 17 Kantsteinsvis 3, left, FV44 sør

	Profil	Bredde	Helling	Metode	Linje	Fri flate
1	-9999.000	0.090	0.000			
2	9999.000	0.090	0.000			

Figur 18 Kantsteinsflate 2, left, FV44 sør

	Profil	Bredde	Helling	Metode	Linje	Fri flate
1	-99999.000	2.900	0.020			
2	-9999.000			↘	avgr. fortau venstre a	-3.15 V. Fortau
3	77.452			↘	avgr. fortau venstre a	-3.15 V. Fortau
4	77.452	0.000	0.000			
5	99999.000	0.000	0.020			

Figur 19 Fortau, left, FV44 sør

1.3.2. Right side

	Profil	Flate	Linjeavgrensning	Avstand	Object
1	-9999.000	3.15 H. Fortau			
2	86.054	3.15 H. Fortau			
3	Brudd				
4	86.054	Primærlinje			
5	9999.000	Primærlinje			

Figur 20 Boundary, right, FV44 sør

	Profil	Bredde	Helling	Metode	Linje	Fri flate
1	-99999.000	3.000	-0.030			
2	-9999.000			↘	avgr. høyre kollektiv skul	1.01 H. Kjørefelt 1
3	9999.000			↘	avgr. høyre kollektiv skul	1.01 H. Kjørefelt 1
4	99999.000	3.000	-0.030			

Figur 21 Kjørefelt 1, right, FV44 sør

	Profil	Bredde	Helling	Metode	Linje	Fri flate
1	-99999.000	0.250	Arv			
2	99999.000	0.250	Arv			

Figur 22 Skulder 1, right, FV44 sør

	Profil	Bredde	Helling	Metode	Linje	Fri flate
1	-99999.000	0.010	13.000			
2	22.507	0.010	13.000			
3	Brudd					
4	22.507	0.000	13.000			
5	99999.000	0.000	13.000			

Figur 23 Kantsteinsvis 1, right, FV44 sør

	Profil	Bredde	Helling	Metode	Linje	Fri flate
1	-99999.000	0.090	0.000			
2	-99999.000			↘	avgr. kjørebane høyre 2	2.19 H. Kantsteinsflate 1
3	67.380			↘	avgr. kjørebane høyre 2	2.19 H. Kantsteinsflate 1
4	67.380	0.000	0.000			
5	99999.000	0.000	0.000			

Figur 24 Kantsteinsflate 1, right, FV44 sør

	Profil	Bredde	Helling	Metode	Linje	Fri flate
1	-99999.000	0.010	-13.000			
2	22.507	0.010	-13.000			
3	Brudd					
4	22.507	0.000	-13.000			
5	99999.000	0.000	-13.000			

Figur 25 Kantsteinsvis 2, right, FV44 sør

	Profil	Bredde	Helling	Metode	Linje	Fri flate
1	-9999.000	0.250	-0.030			
2	57.162	0.250	-0.030			
3	67.380	0.000	-0.030			
4	9999.000	0.000	-0.030			

Figur 26 Skulder 2, right, FV44 sør

	Profil	Bredde	Helling	Metode	Linje	Fri flate
1	-99999.000	3.000	-0.030			
2	-9999.000			↘	avgr. høyre kjørebane sk	3.03 H.Kjørefelt 2
3	Brudd					
4	79.456			↘	avgr. høyre kjørebane sk	3.03 H.Kjørefelt 2
5	79.456			↘↘	avgr. rund. sør FV44 sør	3.03 H.Kjørefelt 2
6	999.000			↘↘	avgr. rund. sør FV44 sør	3.03 H.Kjørefelt 2
7	99999.000	3.000	-0.030			

Figur 27 Kjørefelt 2, right, FV44 sør

	Profil	Bredde	Helling	Metode	Linje	Fri flate
1	-9999.000	0.250	Arv			
2	9999.000	0.250	Arv			

Figur 28 Skulder 3, right, FV44 sør

	Profil	Bredde	Helling	Metode	Linje	Fri flate
1	-9999.000	2.000	-0.030			
2	-9999.000			↘	avgr. sykkel høyre	3.05 H.Sykkelfelt
3	Brudd					
4	53.303			↘	avgr. sykkel høyre	3.05 H.Sykkelfelt
5	53.303			↘↘	avgr. sykkel høyre	3.05 H.Sykkelfelt
6	999.000			↘↘	avgr. sykkel høyre	3.05 H.Sykkelfelt
7	99999.000	2.000	-0.030			

Figur 29 Sykkelfelt, right, FV44 sør

	Profil	Bredde	Helling	Metode	Linje	Fri flate
1	-99999.000	0.010	13.000			
2	99999.000	0.010	13.000			

Figur 30 Kantsteinsvis 3, right, FV44 sør

	Profil	Bredde	Helling	Metode	Linje	Fri flate
1	-9999.000	0.090	0.000			
2	9999.000	0.090	0.000			

Figur 31 Kantsteinsflate 2, right, FV44 sør

	Profil	Bredde	Helling	Metode	Linje	Fri flate
1	-99999.000	2.900	0.020			
2	-9999.000			↙	avgr. fortau høyre	3.15 H. Fortau
3	9999.000			↘	avgr. fortau høyre	3.15 H. Fortau
4	99999.000	2.900	0.020			

Figur 32 Fortau, right, FV44 sør

2. Hillevågstunnelen (Ht.)

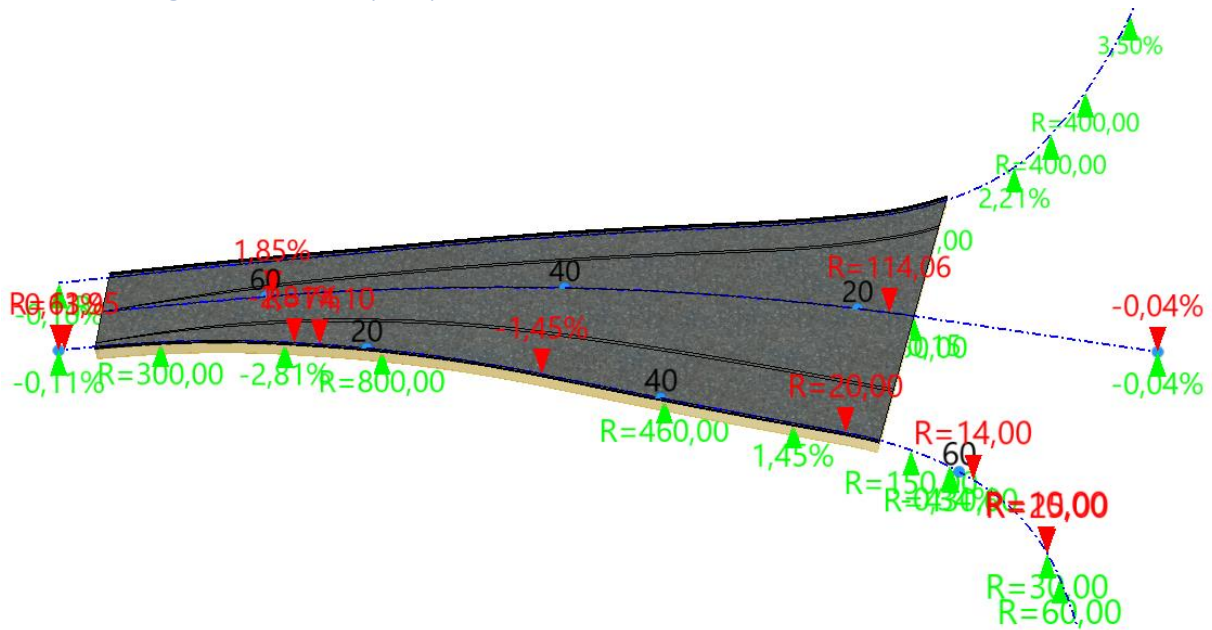

Figur 33 Hillevågstunnelen (view from south)

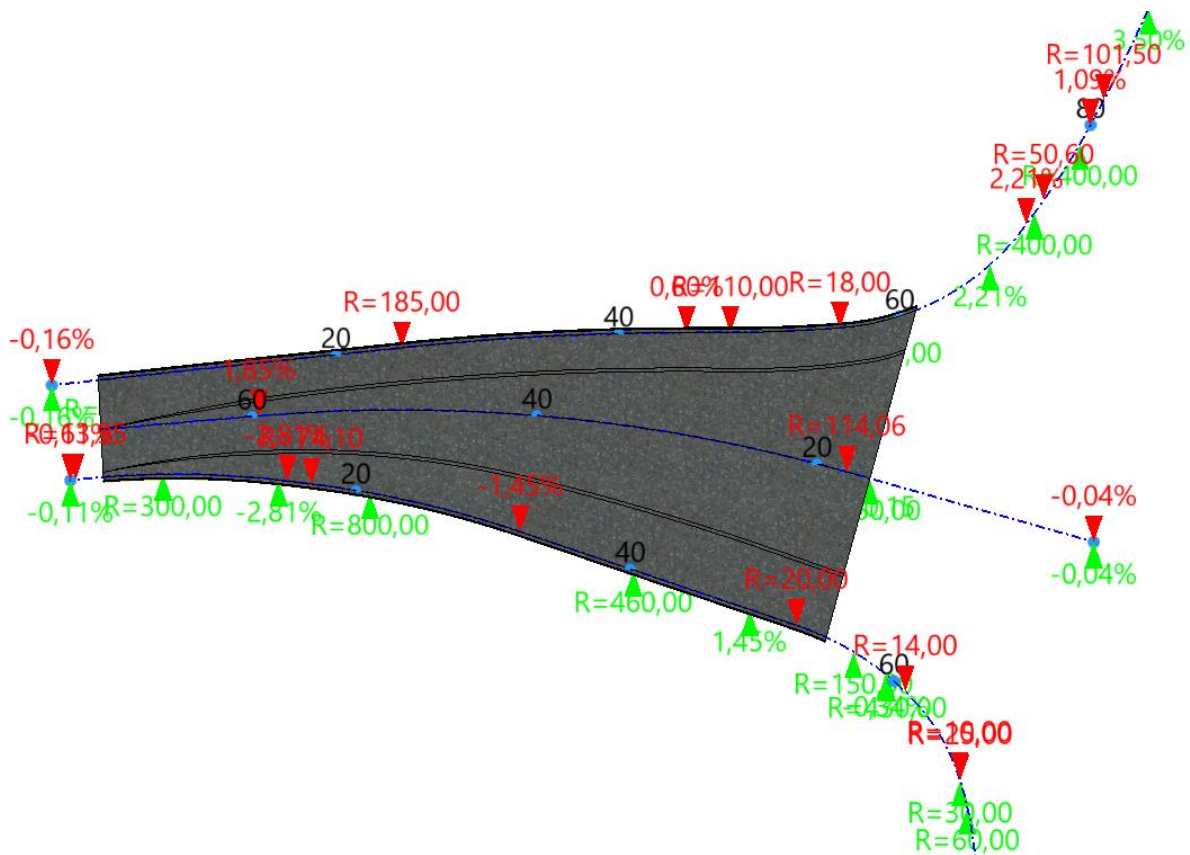

Figur 34 Hillevågstunnelen (view from top)

2.1. Horizontal geometry

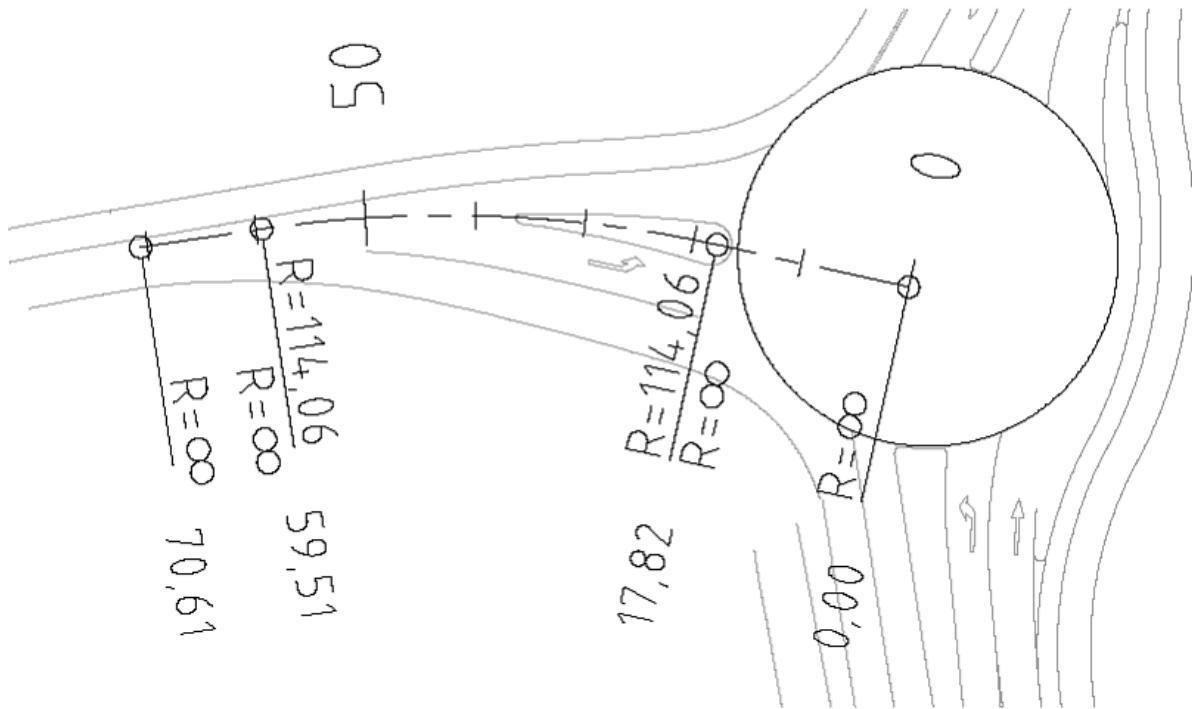

Figur 35 Horizontal geometry, Hillevågstunnelen

Nr.	Elementtype	Innspenning	Radius	Lengde	Param.	Retning	Buetype	Øst1	Nord1	Øst2	Nord2
1	Rettlinje	×—×		17,822		2,924		113937,038	1106045,232	113920,933	1106048,788
2	Sirkelbue	⊖	-114,055011	41,685			Kort				
3	Rettlinje	×—×		11,100		3,290		113880,304	1106050,820	113867,229	1106048,868

Figur 36 Horizontal alignment, input data, Hillevågstunnelen

2.2. Vertical geometry

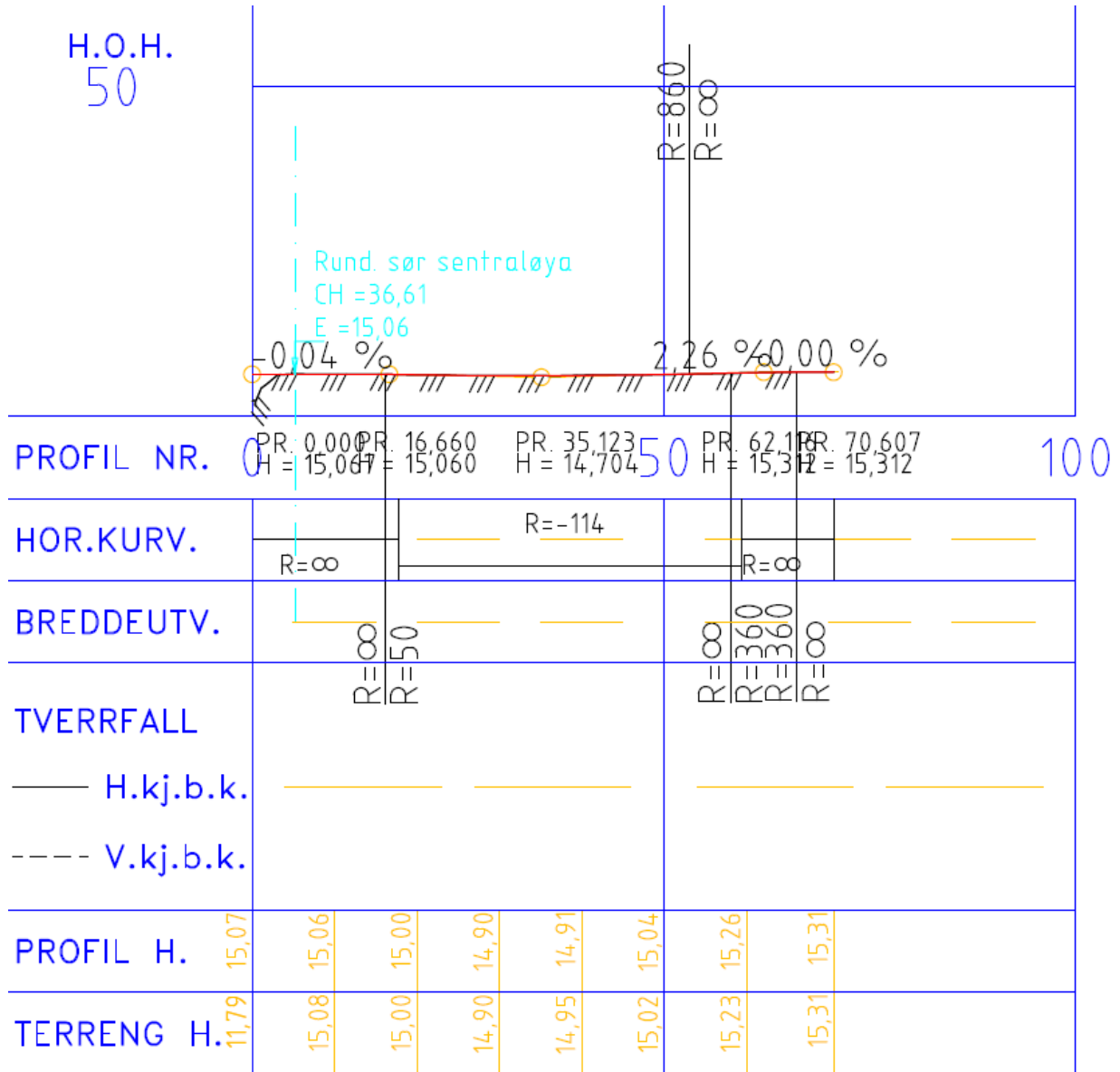

Hillevågstunnelen

Figur 37 Vertical alignment, Hillevågstunnelen

2.3. Vegoverflater

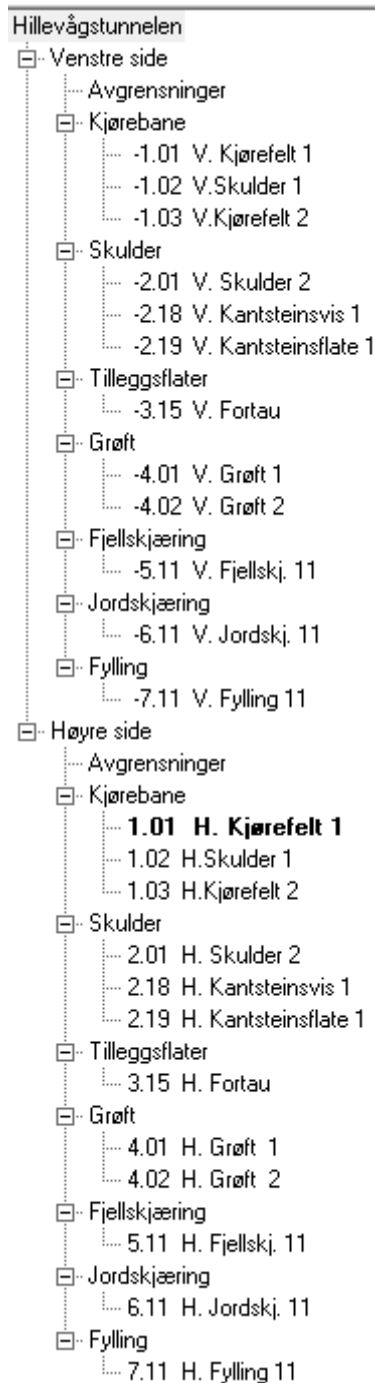

Figur 38 List of all surfaces for Hillevågstunnelen

2.3.1. Left side

	Profil	Flate	Linjeavgrensning	Avstand	Object
1	-999.000	Primærlinje		0.000	
2	16.160	Primærlinje		0.000	
3	Brudd				
4	16.160	-2.19 V. Kantsteinsflate 1		0.000	
5	999.000	-2.19 V. Kantsteinsflate 1		0.000	

Figur 39 Boundary, left, Ht.

	Profil	Bredde	Helling	Metode	Linje	Fri flate
1	-99999.000	11.200	-0.030			
2	-999.000			↕	avgr.rund. sør FV44 sør	-1.01 V. Kjørefelt 1
3	999.000			↕	avgr.rund. sør FV44 sør	-1.01 V. Kjørefelt 1
4	99999.000	3.800	-0.030			

Figur 40 Kjørefelt 1, left, Ht.

	Profil	Bredde	Helling	Metode	Linje	Fri flate
1	-999.000	0.250	Arv			
2	60.206	0.250	Arv			
3	70.607	0.000	Arv			
4	999.000	0.000	Arv			

Figur 41 Skulder, left, Ht.

	Profil	Bredde	Helling	Metode	Linje	Fri flate
1	-999.000	5.000	-0.030			
2	-999.000			↕	avgr. rund. sør Tunnelen	-1.03 V.Kjørefelt 2
3	999.000			↕	avgr. rund. sør Tunnelen	-1.03 V.Kjørefelt 2
4	999.000	5.000	-0.030			

Figur 42 Kjørefelt, left, Ht.

	Profil	Bredde	Helling	Metode	Linje	Fri flate
1	-99999.000	0.250	Arv			
2	99999.000	0.250	Arv			

Figur 43 Skulder 2, left, Ht.

	Profil	Bredde	Helling	Metode	Linje	Fri flate
1	-99999.000	0.010	13.000			
2	99999.000	0.010	13.000			

Figur 44 Kantsteinsvis 1, left, Ht.

	Profil	Bredde	Helling	Metode	Linje	Fri flate
1	-99999.000	0.090	0.000			
2	99999.000	0.090	0.000			

Figur 45 Kantsteinsflate 1, left, Ht.

2.3.2. Right side

	Profil	Flate	Linjeavgrensning	Avstand	Object
1	-999.000	Primærlinje		0.000	
2	16.160	Primærlinje		0.000	
3	Brudd				
4	16.160	2.19 H. Kantsteinsflate 1		0.000	
5	999.000	2.19 H. Kantsteinsflate 1		0.000	

Figur 46 Boundary, right, Ht.

	Profil	Bredde	Helling	Metode	Linje	Fri flate
1	-99999.000	3.000	-0.030			
2	13.347			↕	avgr. rund. sør FV44 til T	1.01 H. Kjørefelt 1
3	999.000			↕	avgr. rund. sør FV44 til T	1.01 H. Kjørefelt 1
4	99999.000	15.000	-0.030			

Figur 47 Kjørefelt 1, right, Ht.

	Profil	Bredde	Helling	Metode	Linje	Fri flate
1	-999.000	0.250	Arv			
2	60.206	0.250	Arv			
3	70.607	0.000	Arv			
4	999.000	0.000	Arv			

Figur 48 Skulder, right, Ht.

	Profil	Bredde	Helling	Metode	Linje	Fri flate
1	-999.000	0.000	0.000			
2	13.347			↕	avgr. rund. sør Tunnelen	1.03 H.Kjørefelt 2
3	999.000			↕	avgr. rund. sør Tunnelen	1.03 H.Kjørefelt 2
4	999.000	0.000	0.000			

Figur 49 Kjørefelt 2, right, Ht.

	Profil	Bredde	Helling	Metode	Linje	Fri flate
1	-99999.000	0.250	Arv			
2	99999.000	0.250	Arv			

Figur 50 Skulder 2, right, Ht.

	Profil	Bredde	Helling	Metode	Linje	Fri flate
1	-99999.000	0.010	13.000			
2	99999.000	0.010	13.000			

Figur 51 Kantsteinsvis 1, right, Ht.

	Profil	Bredde	Helling	Metode	Linje	Fri flate
1	-99999.000	0.090	0.000			
2	99999.000	0.090	0.000			

Figur 52 Kantsteinsflate 1, right, Ht.

3. Rundkjøringen, sør, sentraløya (Rss.)

On pictures below, marked alle three rund. utvidelse which makes boundary for Kjørefelt 2, right.

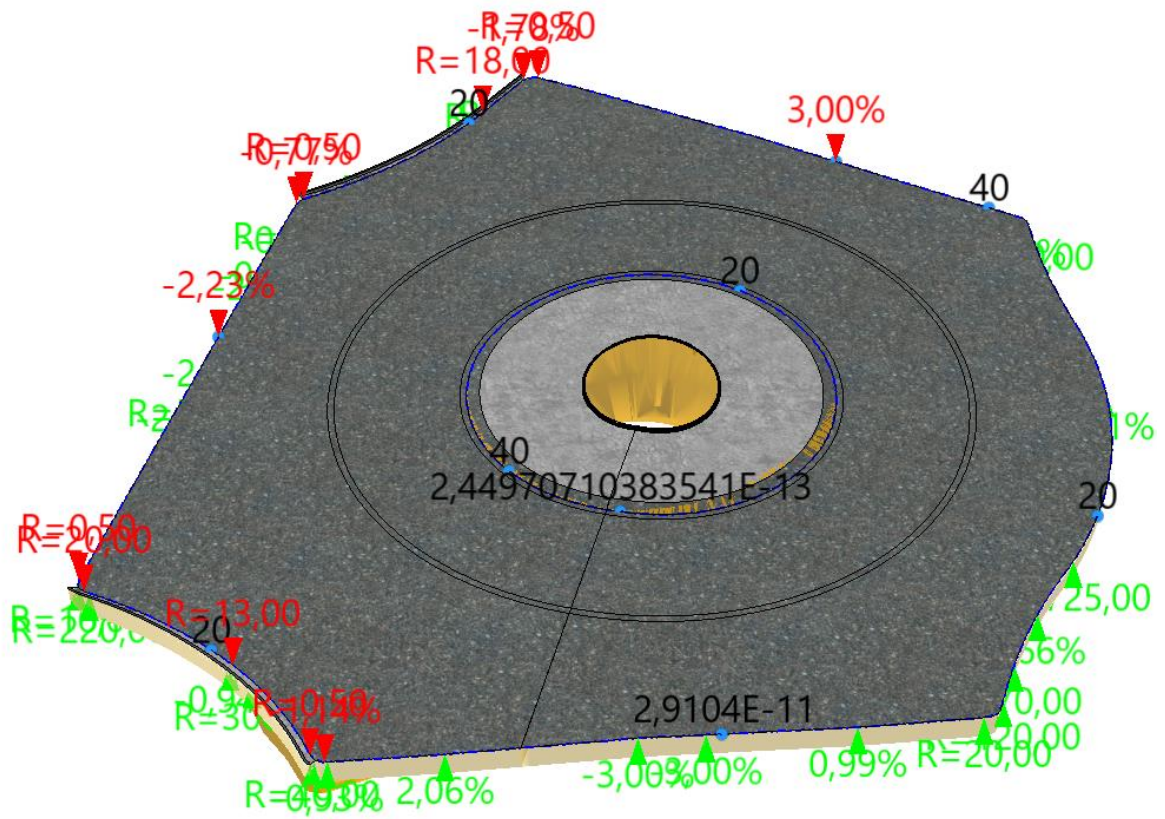

Figur 53 Rund. sør sentraløya (view from south)

3.2. Vertical geometry

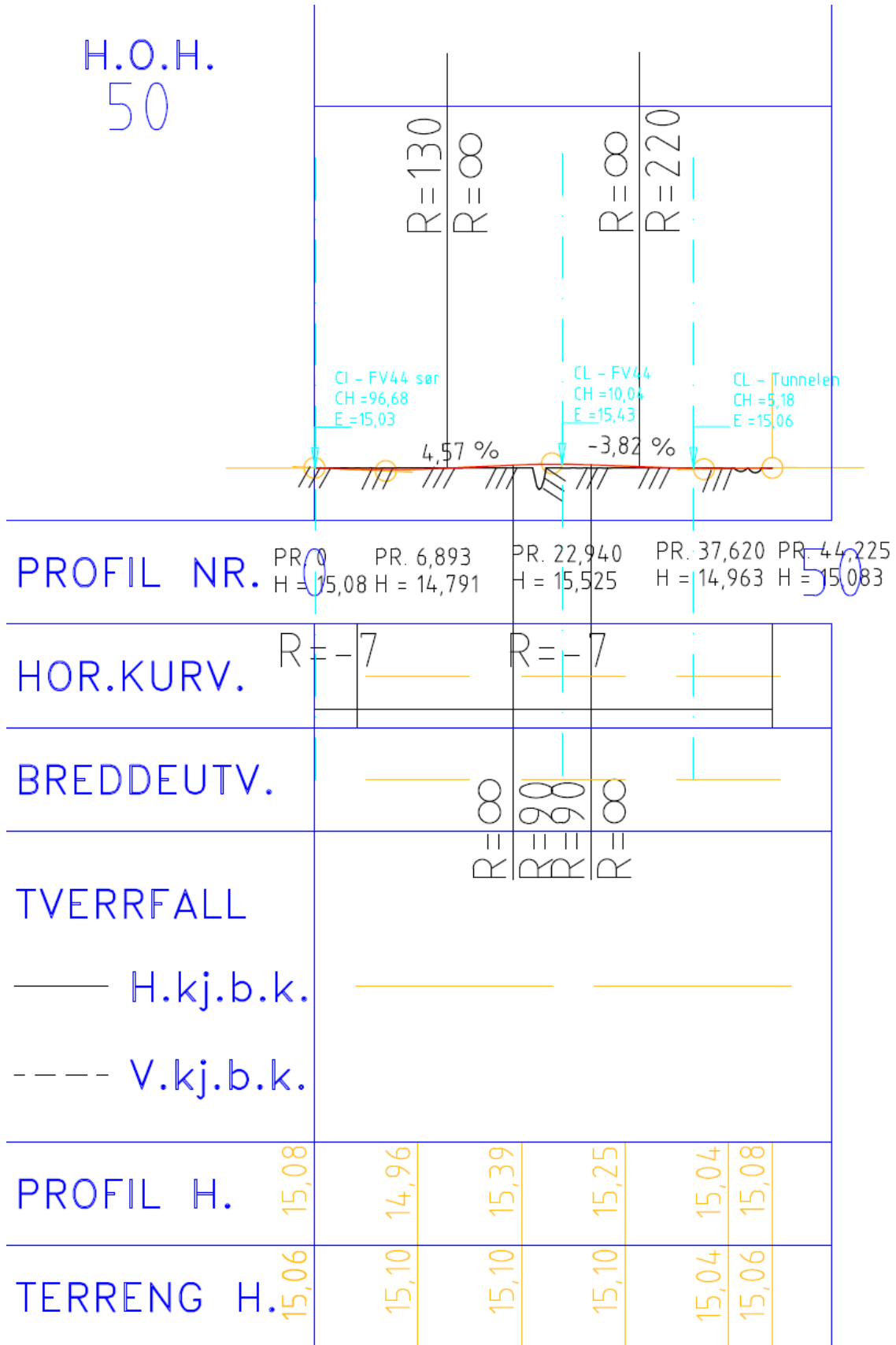

Rundkjøring sør

Figur 56 Vertical alignment, rundkjøring sør sentraløya

3.3. Vegoverflater

Rund. sør sentraløya	
[-] Venstre side	
... Avgrensninger	
[-] Kjørebane	
... -1.02 V.Kantsteinsvis 1	
[-] Skulder	
... -2.01 V. Kantsteinsflate 1	
... -2.18 V. Kantsteinsvis 2	
... -2.19 V. Kantsteinsflate 2	
[+] Tilleggsflater	
[+] Grøft	
[+] Fjellskjæring	
[+] Jordskjæring	
[+] Fylling	
[-] Høyre side	
... Avgrensninger	
[-] Kjørebane	
... 1.01 H. Skulder 1	
... 1.02 H.Kjørefelt 1	
... 1.03 H.Skulder 2	
... 1.04 H.Kjørefelt 2	
[-] Skulder	
... 2.01 H. Skulder 3	
... 2.18 H. Kantsteinsvis 1	
... 2.19 H. Kantsteinsflate 1	
[+] Tilleggsflater	
[+] Grøft	
[+] Fjellskjæring	
[+] Jordskjæring	
[+] Fylling	

Figur 57 List of all surfaces for Rundkjøringen sør sentraløya

3.3.1. Left side

	Profil	Flate	Linjeavgrensning	Avstand	Object
1	-99.000	-2.19 V. Kantsteinsflate 2		0.000	
2	99.000	-2.19 V. Kantsteinsflate 2		0.000	

Figur 58 Boundary, left, Rss.

	Profil	Bredde	Helling	Metode	Linje	Fri flate
1	-999.000	0.500	0.260			
2	999.000	0.500	0.260			

Figur 59 Kantsteinsvis 1, left, Rss.

	Profil	Bredde	Helling	Metode	Linje	Fri flate
1	-99999.000	3.900	0.000			
2	99999.000	3.900	0.000			

Figur 60 Kantsteinsflate 1, left, Rss.

	Profil	Bredde	Helling	Metode	Linje	Fri flate
1	-99999.000	0.010	13.000			
2	99999.000	0.010	13.000			

Figur 61 Kantsteinsvis 2, left, Rss.

	Profil	Bredde	Helling	Metode	Linje	Fri flate
1	-99999.000	0.090	0.000			
2	99999.000	0.090	0.000			

Figur 62 Kantsteinsflate 2, left, Rss.

3.3.2. Right side

	Profil	Flate	Linjeavgrensning	Avstand	Object
1	-99999.000	1.04 H.Kjørefelt 2		0.000	
2	0.000	1.04 H.Kjørefelt 2		0.000	
3	5.978	1.04 H.Kjørefelt 2		0.000	
4	Brudd				
5	5.978	1.04 H.Kjørefelt 2		0.000	
6	16.948	1.04 H.Kjørefelt 2		0.000	
7	Brudd				
8	16.948	1.04 H.Kjørefelt 2		0.000	
9	25.551	1.04 H.Kjørefelt 2		0.000	
10	Brudd				
11	25.551	2.19 H. Kantsteinsflate 1		0.000	
12	29.825	2.19 H. Kantsteinsflate 1		0.000	
13	Brudd				
14	29.825	1.04 H.Kjørefelt 2		0.000	
15	38.280	1.04 H.Kjørefelt 2		0.000	
16	Brudd				
17	38.280	2.19 H. Kantsteinsflate 1		0.000	
18	42.157	2.19 H. Kantsteinsflate 1		0.000	
19	Brudd				
20	42.157	1.04 H.Kjørefelt 2		0.000	
21	99.000	1.04 H.Kjørefelt 2		0.000	
22	99999.000	1.04 H.Kjørefelt 2		0.000	

Figur 63 Boundary, right, Rss.

	Profil	Bredde	Helling	Metode	Linje	Fri flate
1	-99999.000	0.250	-0.030			
2	0.000	0.250	-0.030			
3	22.000	0.250	0.030			
4	44.225	0.250	-0.030			
5	99999.000	0.250	-0.030			

Figur 64 Skulder 1, right, Rss.

	Profil	Bredde	Helling	Metode	Linje	Fri flate
1	-999.000	4.750	Arv			
2	999.000	4.750	Arv			

Figur 65 Kjørefelt 1, right, Rss.

	Profil	Bredde	Helling	Metode	Linje	Fri flate
1	-999.000	0.250	Arv			
2	999.000	0.250	Arv			

Figur 66 Skulder 2, right, Rss.

	Profil	Bredde	Helling	Metode	Linje	Fri flate
1	-999.000	5.000	Arv			
2	0.000			↕	rund. utvidelse tunnelen	1.04 H.Kjørefelt 2
3	2.325			↕	rund. utvidelse tunnelen	1.04 H.Kjørefelt 2
4	2.325			↕	rund. utvidelse fra sør til	1.04 H.Kjørefelt 2
5	20.331			↕	rund. utvidelse fra sør til	1.04 H.Kjørefelt 2
6	20.331			↕	rund. utvidelse fv44 til tu	1.04 H.Kjørefelt 2
7	33.530			↕	rund. utvidelse fv44 til tu	1.04 H.Kjørefelt 2
8	33.530			↕	rund. utvidelse tunnelen	1.04 H.Kjørefelt 2
9	99.000			↕	rund. utvidelse tunnelen	1.04 H.Kjørefelt 2
10	999.000	5.000	Arv			

Figur 67 Kjørefelt 2, right, Rss.

	Profil	Bredde	Helling	Metode	Linje	Fri flate
1	-99999.000	0.250	Arv			
2	0.000	0.000	Arv			
3	5.978	0.000	Arv			
4	Brudd					
5	5.978	0.250	Arv			
6	16.948	0.250	Arv			
7	Brudd					
8	16.948	0.000	Arv			
9	25.551	0.000	Arv			
10	Brudd					
11	25.551	0.250	Arv			
12	29.825	0.250	Arv			
13	Brudd					
14	29.825	0.000	Arv			
15	38.280	0.000	Arv			
16	Brudd					
17	38.280	0.250	Arv			
18	42.157	0.250	Arv			
19	Brudd					
20	42.157	0.000	Arv			
21	99.000	0.000	Arv			
22	99999.000	0.250	Arv			

Figur 68 Skulder 3, right, Rss.

There is no need to divide Skulder 3 to so many parts, and it would be enough to just use boundary, but during process, first boundary for Skulder 3 were made and then copied profiles to boundary.

	Profil	Bredde	Helling	Metode	Linje	Fri flate
1	-99999.000	0.010	13.000			
2	99999.000	0.010	13.000			

Figur 69 Kantsteinsvis 1, right, Rss.

	Profil	Bredde	Helling	Metode	Linje	Fri flate
1	-99999.000	0.090	0.000			
2	99999.000	0.090	0.000			

Figur 70 Kantsteinsflate 1, right, Rss.

4. Rundkjøringen sør øst sykkel og fortau (Rsø.)

Road task Rundkjøringen sør øst sykkel og fortau is based on line task rund. Utvidelse fra sør til nord fv44.

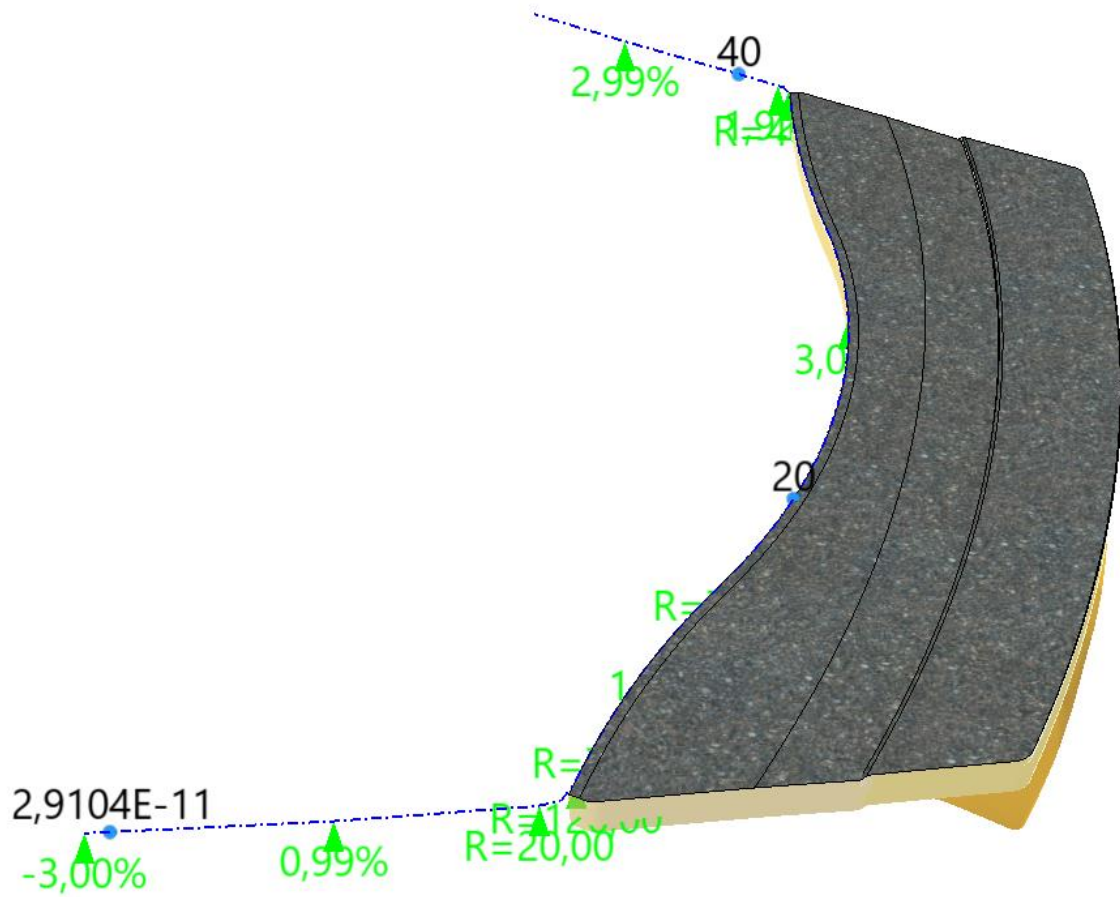

Figur 71 Rund. sør øst sykkel og fortau (view from south)

4.2. Vertical geometry

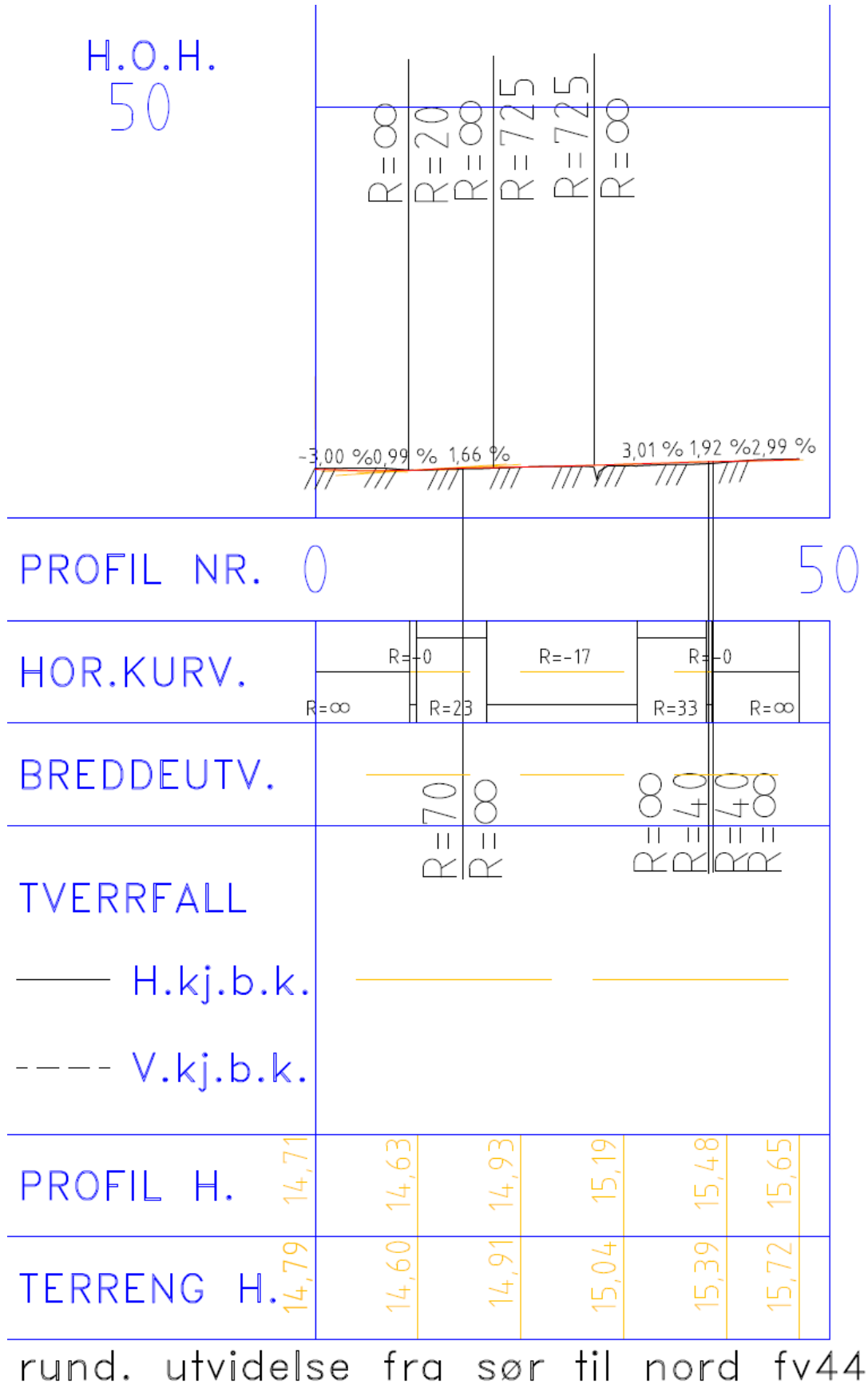

Figur 74 Vertical alignment, rund. utvidelse fra sør til nord fv44

4.3. Vegoverflater

rund. sør øst sykkel og fortau	
[-] Venstre side	
... Avgrensninger	
[-] Kjørebane	
[-] Skulder	
[-] Tilleggsflater	
[-] Grøft	
[-] Fjellskjæring	
[-] Jordskjæring	
[-] Fylling	
[-] Høyre side	
... Avgrensninger	
[-] Kjørebane	
... 1.01 H. Skulder 1	
... 1.02 H. Skulder 2	
... 1.15 H. Sykkelfelt	
[-] Skulder	
... 2.01 H. Skulder 3	
... 2.18 H. Kantsteinsvis 1	
... 2.19 H. Kantsteinsflate 1	
[-] Tilleggsflater	
... 3.15 H. Fortau	
[-] Grøft	
[-] Fjellskjæring	
[-] Jordskjæring	
[-] Fylling	

Figur 75 List of all surfaces for rund. sør øst sykkel og fortau

4.3.1. Left side

	Profil	Flate	Linjeavgrensning	Avstand	Object
1	-99.000	Primærlinje		0.000	
2	99.000	Primærlinje		0.000	

Figur 76 Boundary, left, Rsø.

4.3.2. Right side

	Profil	Flate	Linjeavgrensning	Avstand	Object
1	-99.000		avgr. rund. sør fortau	0.000	
2	99.000		avgr. rund. sør fortau	0.000	

Figur 77 Boundary, right, Rsø.

	Profil	Bredde	Helling	Metode	Linje	Fri flate
1	-99999.000	0.250	-0.030			
2	99999.000	0.250	-0.030			

Figur 78 Skulder 1, right, Rsø.

	Profil	Bredde	Helling	Metode	Linje	Fri flate
1	-99.000	0.000	0.000			
2	-99.000			↕	avgr. rund. sør øy en del	1.02 H.Skulder 2
3	99.000			↕	avgr. rund. sør øy en del	1.02 H.Skulder 2
4	99.000	0.000	0.000			

Figur 79 Skulder 2, right, Rsø.

	Profil	Bredde	Helling	Metode	Linje	Fri flate
1	-99.000	3.000	-0.030			
2	-99.000			↕	avgr. sykkel høyre	1.15 H. Sykkelfelt
3	99.000			↕	avgr. sykkel høyre	1.15 H. Sykkelfelt
4	99.000	3.000	-0.030			

Figur 80 Sykkelfelt, right, Rsø.

	Profil	Bredde	Helling	Metode	Linje	Fri flate
1	-99999.000	0.000	Arv			
2	99999.000	0.000	Arv			

Figur 81 Skulder 3, right, Rsø.

	Profil	Bredde	Helling	Metode	Linje	Fri flate
1	-99999.000	0.010	13.000			
2	99999.000	0.010	13.000			

Figur 82 Kantsteinsvis 1, right, Rsø.

	Profil	Bredde	Helling	Metode	Linje	Fri flate
1	-99999.000	0.090	0.000			
2	99999.000	0.090	0.000			

Figur 83 Kantsteinsflate 1, right, Rsø.

	Profil	Bredde	Helling	Metode	Linje	Fri flate
1	-99999.000	2.900	0.020			
2	-99.000			↕	avgr. fortau høyre	3.15 H. Fortau
3	99.000			↕	avgr. fortau høyre	3.15 H. Fortau
4	99999.000	2.900	0.020			

Figur 84 Fortau, right, Rsø.

5. Rundkjøringen utvidelse fv44 til tunnelen

Rundkjøringen utvidelse fv44 til tunnelen is only as line task and there is no road task, thus no 3D model.

5.1. Horizontal geometry

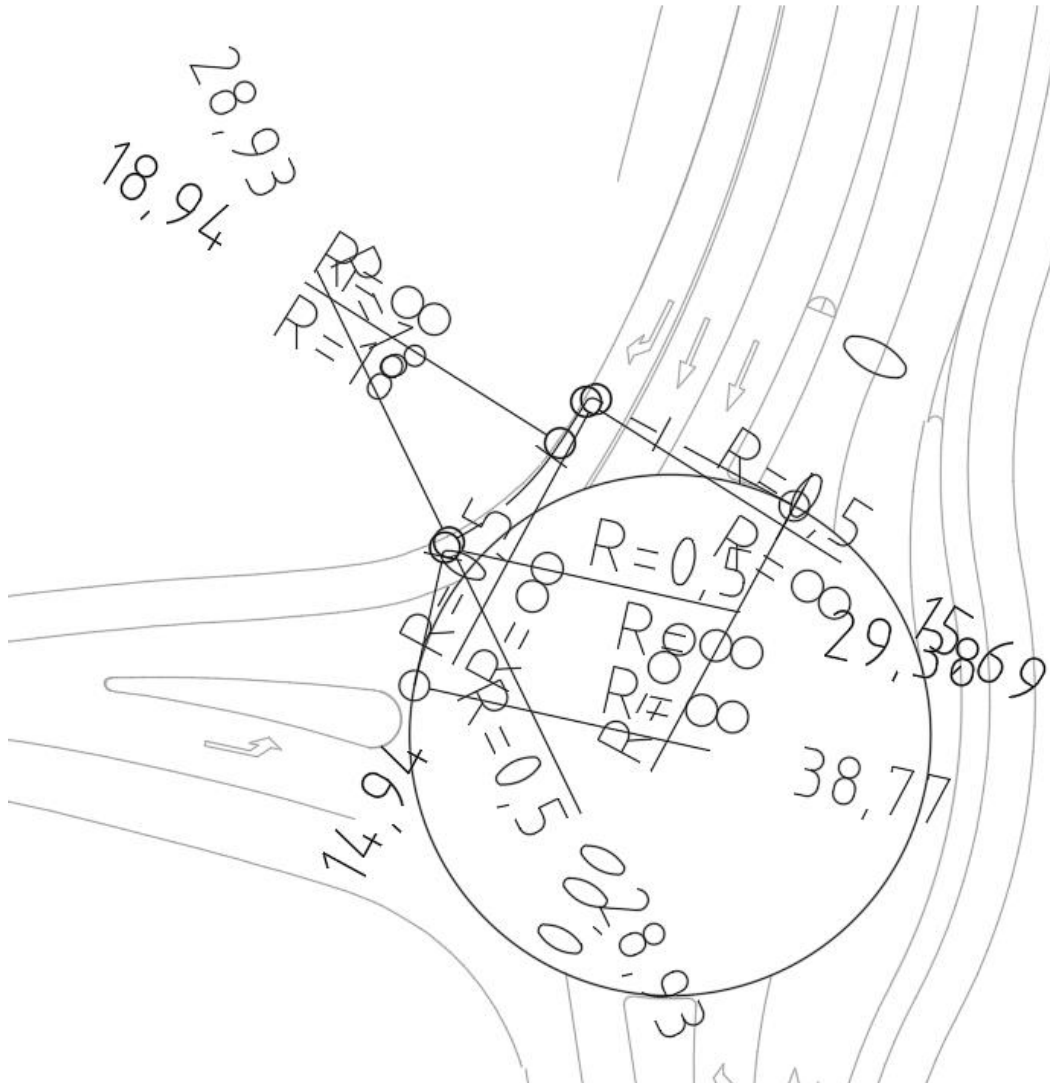

Figur 85 Horizontal alignment, rund. utvidelse fv44 til tunnelen

Nr.	Elementtype	Innspenning	Radius	Lengde	Param.	Retning	Buetype	Øst1	Nord1	Øst2	Nord2
1	Rettlinje	×—×		14,936		2,646		113947,029	1106063,273	113933,710	1106070,470
2	Sirkelbue	—×	-0,500	0,751			Kort	113933,214	1106070,177		
3	Rettlinje	—×		3,250		0,000		113931,902	1106068,101		
4	Sirkelbue	—×	18,000	9,996			Kort	113924,315	1106060,962		
5	Sirkelbue	—×	-0,500	0,451			Kort	113923,867	1106060,531		
6	Rettlinje	—×		9,389		0,000		113921,843	1106051,364		

Figur 86 Horizontal alignment, input data, rund. utvidelse fv44 til tunnelen

5.2. Vertical geometry

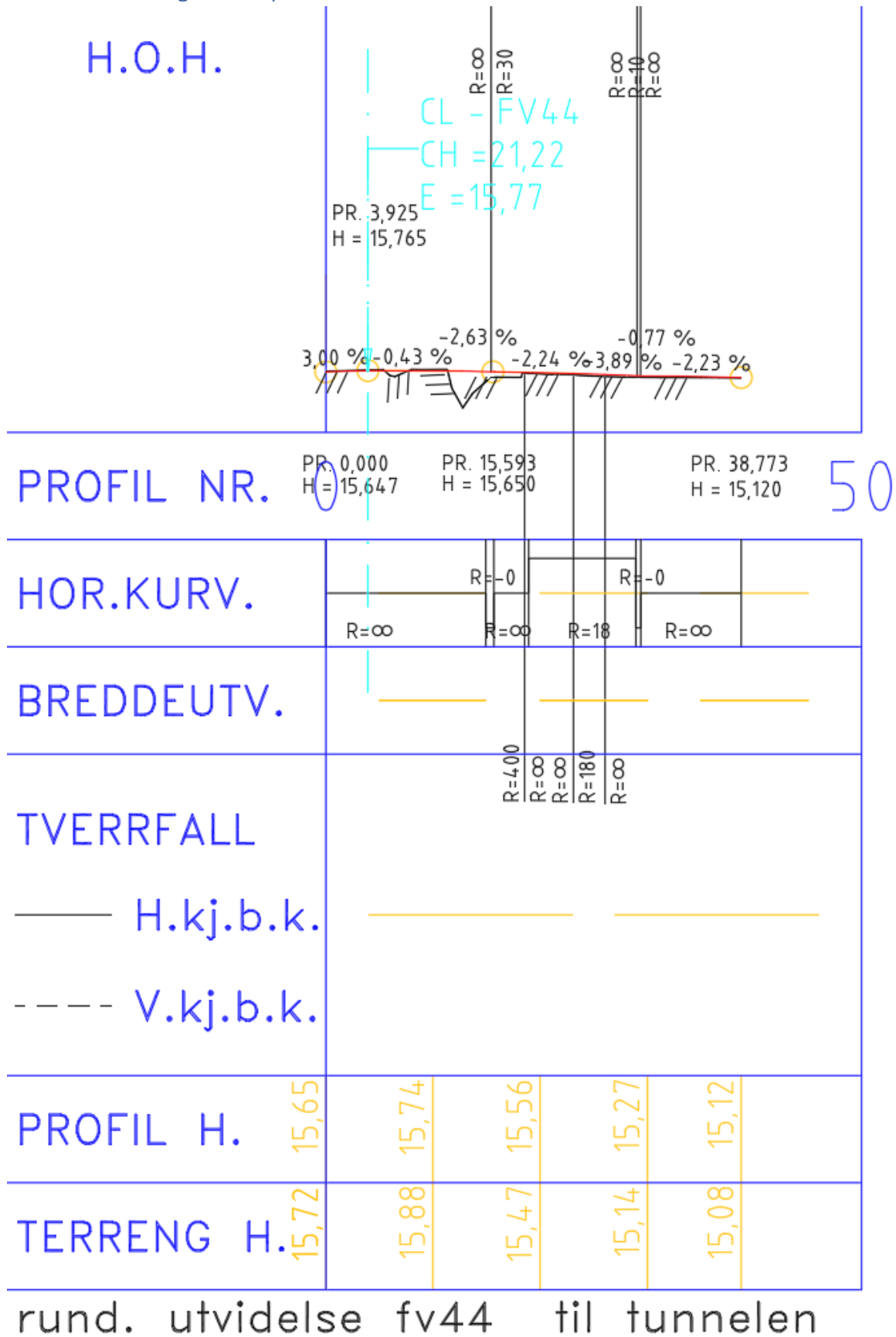

Figur 87 Vertical alignment, rundkjøringen utvidelse fv44 til tunnelen

6. Rundkjøringen utvidelse tunnelen til fv44 sør

Rundkjøringen utvidelse tunnelen til fv44 sør is only a line task and there is no road task, thus no 3D model.

6.1. Horizontal geometry

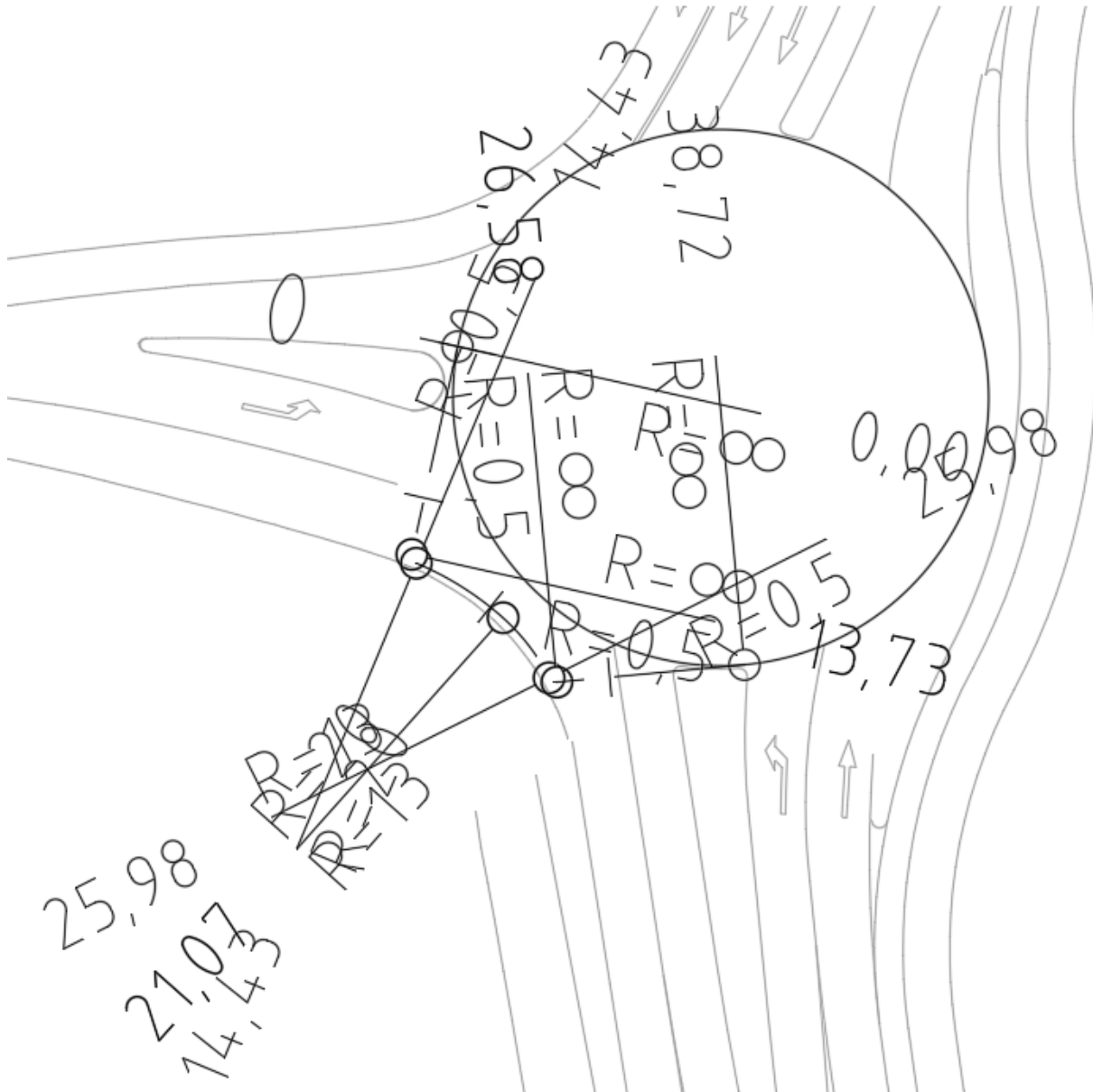

Figur 88 Horizontal alignment, rundkjøringen utvidelse tunnelen til fv44 sør

Nr.	Elementtype	Innspenning	Radius	Lengde	Param.	Retning	Buetype	Øst1	Nord1	Øst2	Nord2
1	Rettlinje	↔		13.731		4.495		113921.843	1106051.364	113918.833	1106037.731
2	Sirkelbue	↔	-0.500	0.696			Kort	113919.196	1106037.380		
3	Sirkelbue	↔	20.000	6.642			Kort	113924.068	1106034.466		
4	Sirkelbue	↔	13.000	4.913			Kort	113927.736	1106030.010		
5	Sirkelbue	↔	-0.500	0.599			Kort	113928.229	1106029.715		
6	Rettlinje	↔		12.141		0.000		113940.328	1106030.842		

Figur 89 Horizontal alignment, input data, rundkjøringen utvidelse tunnelen til fv44 sør

6.2. Vertical geometry

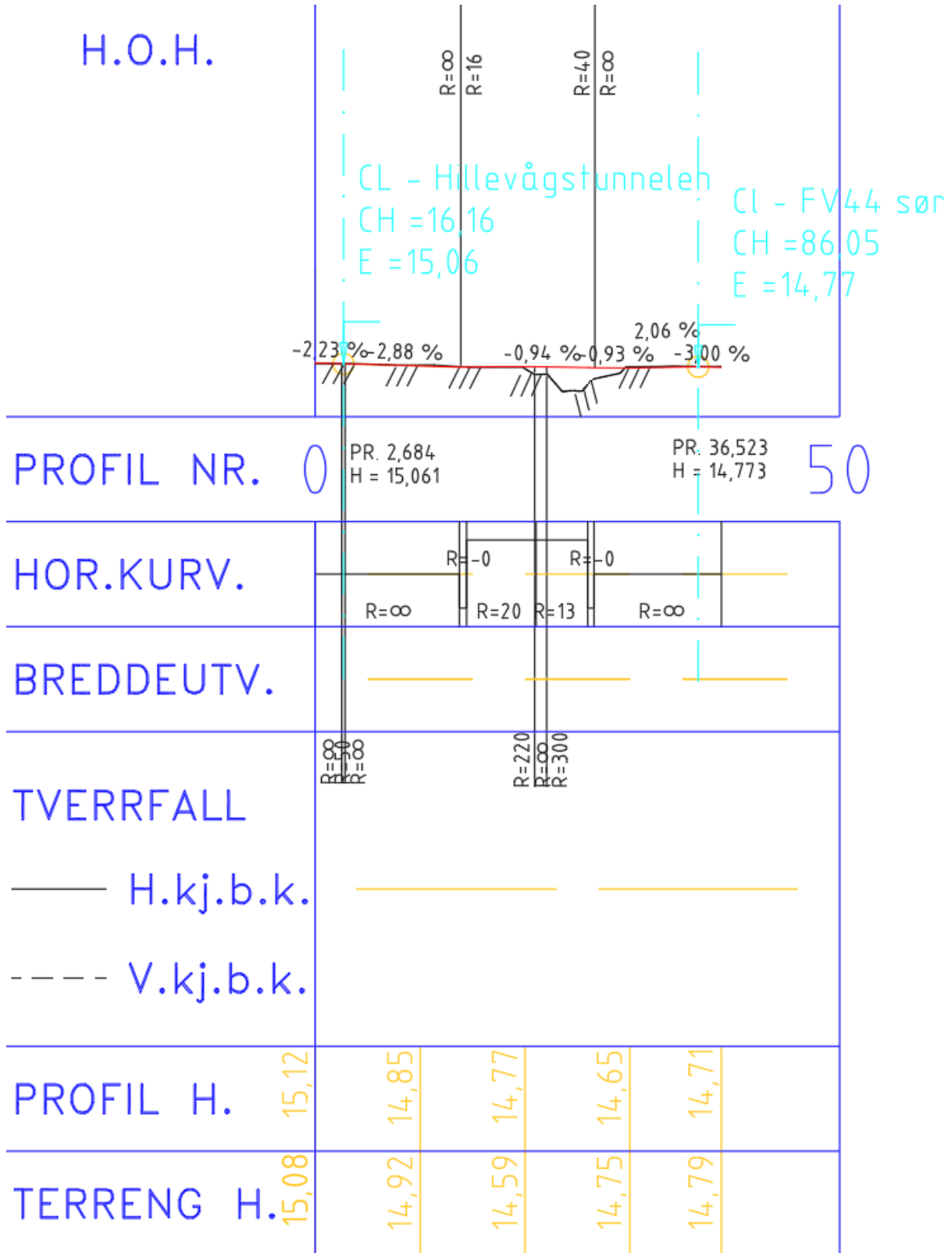

rund. utvidelse tunnelen til fv44 sør

Figur 90 Vertical alignment, rundkjøringen utvidelse tunnelen til fv44 sør

7. FV44

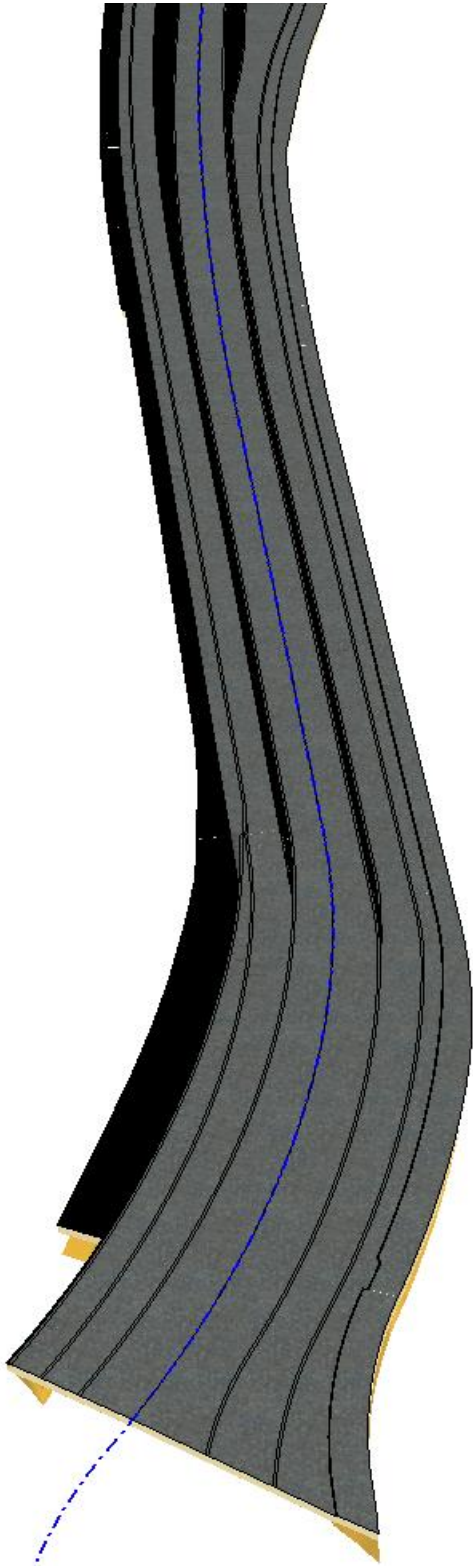

Figur 91 FV44 until T intersection (view from south)

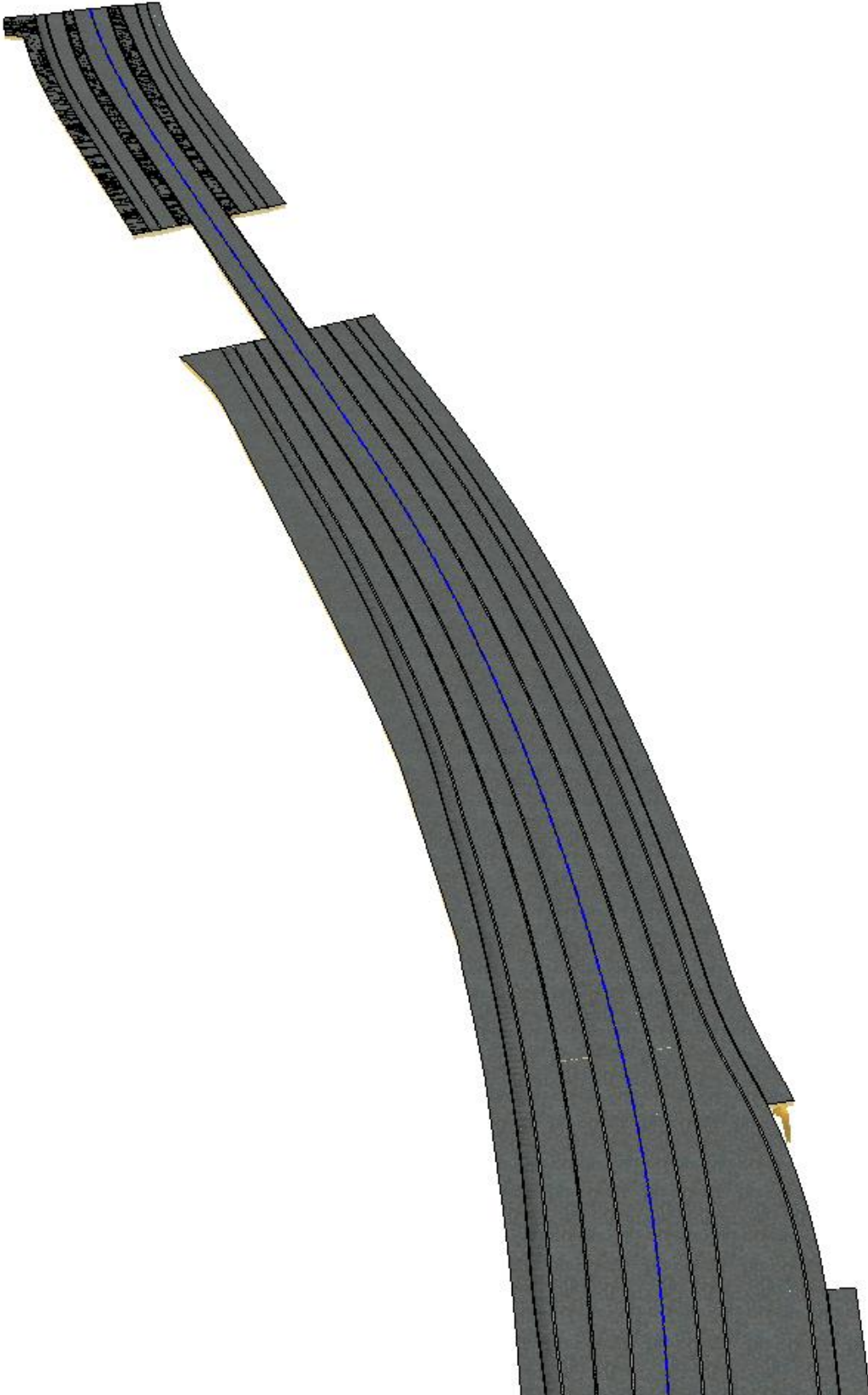

Figur 92 FV44 from T intersection (view from south)

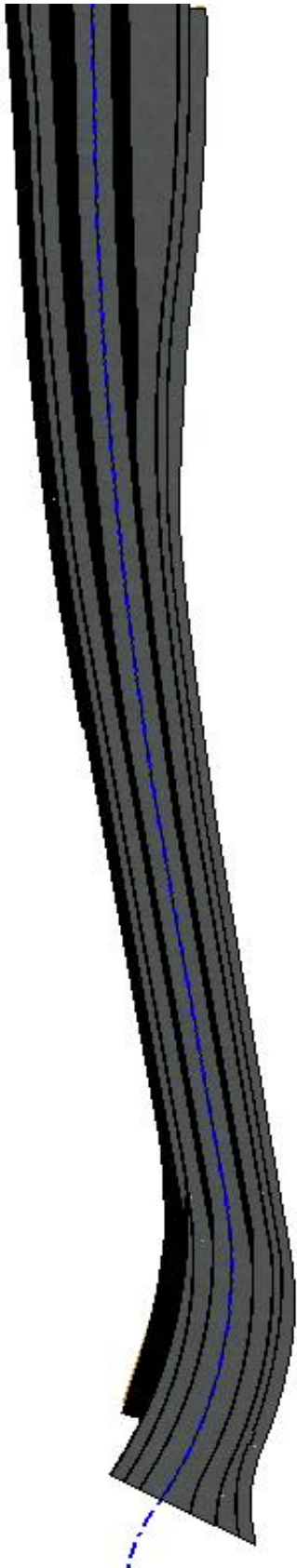

Figur 93 FV44 to T intersection (view from top)

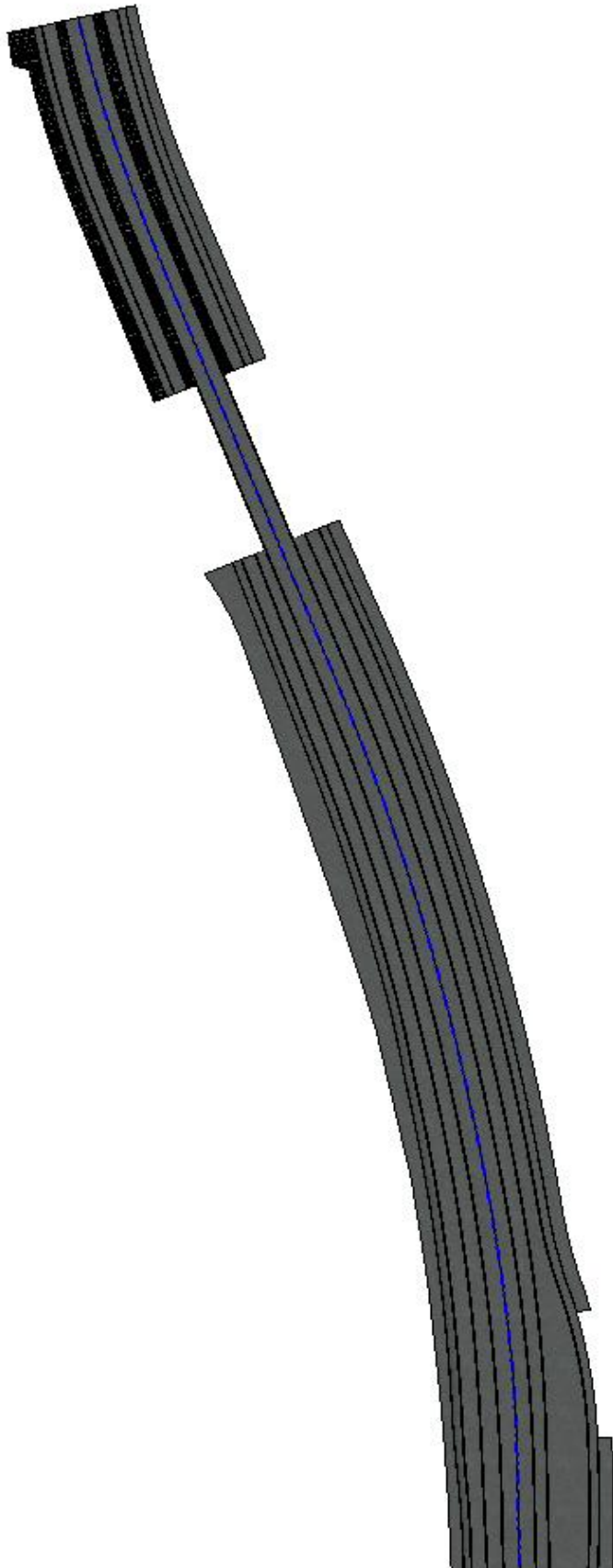

Figur 94 FV44 from T intersection (view from top)

7.1. Horizontal geometry

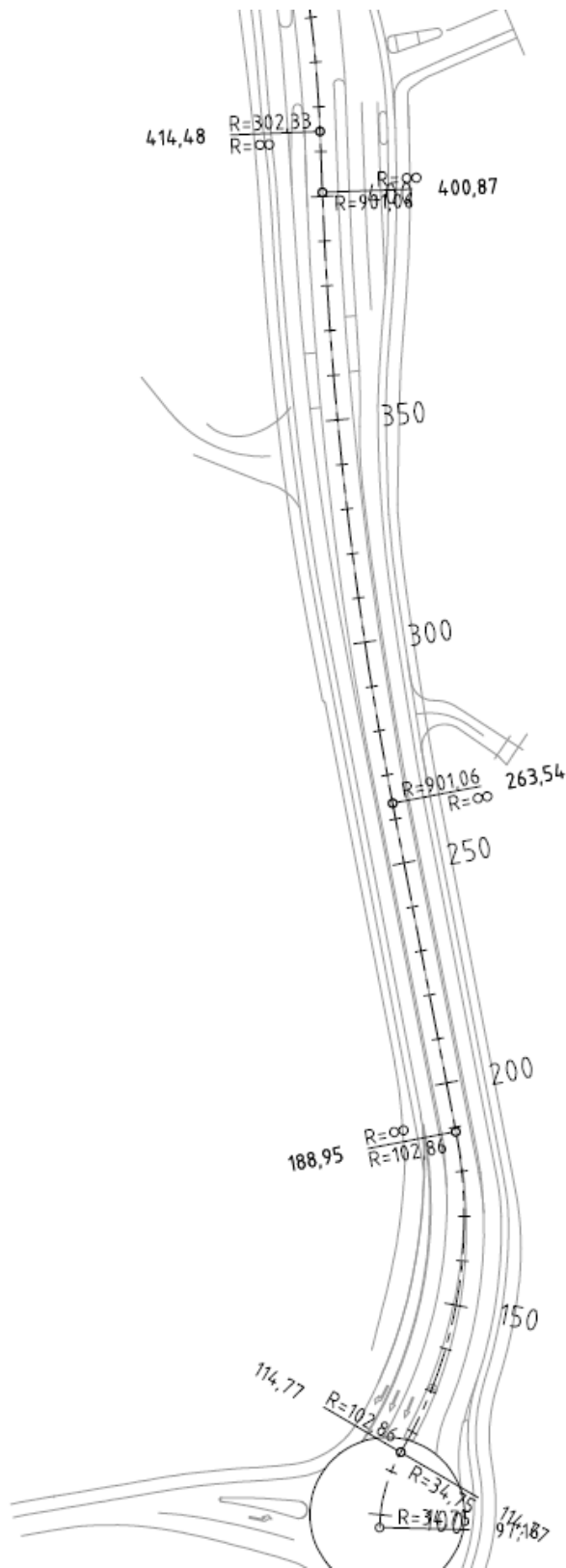

Figur 95 Horizontal alignment FV44 to T-intersection

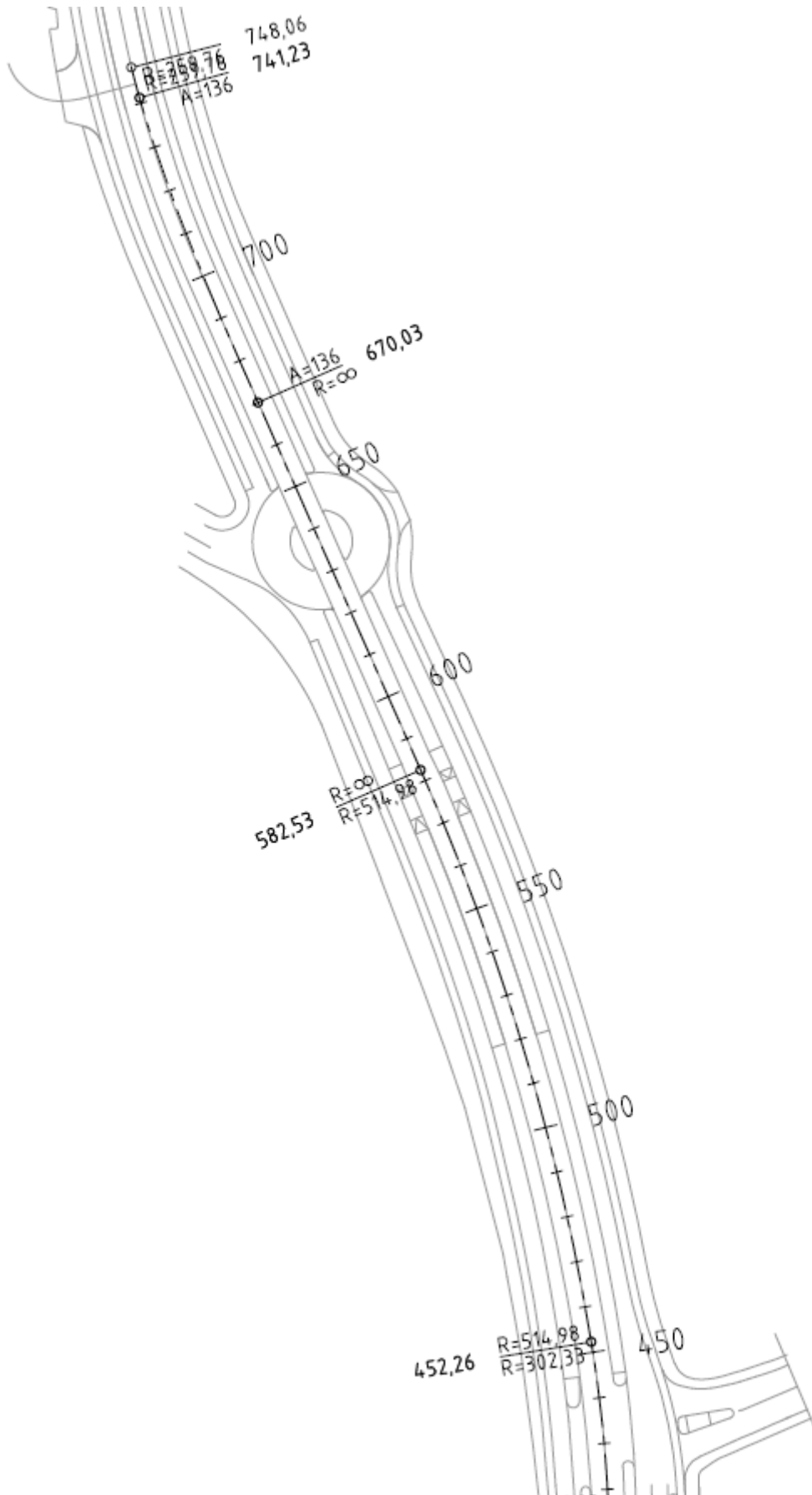

Figur 96 Horizontal alignment FV44 from T-intersection

Nr.	Elementtype	Innspenning	Radius	Lengde	Param.	Retning	Buetype	Øst1	Nord1	Øst2	Nord2
1	Sirkelbue	×—×	34.750781	17.616			Kort	113937.038	1106045.232	113941.859	1106062.086
2	Sirkelbue	—○—	-102.85751	74.174			Kort				
3	Rettlinje	×—×		74.598		1.761		113955.306	1106127.176	113939.989	1106206.552
4	Sirkelbue	—○—	901.064	137.324			Kort				
5	Rettlinje	×—×		13.612		1.609		113924.286	1106342.984	113923.760	1106356.755
6	Sirkelbue	—○—	-302.330	37.784			Kort				
7	Sirkelbue	×—×	-514.977	130.269			Kort	113920.029	1106393.860	113882.809	1106518.852
8	Rettlinje	—○—		87.496		0.000		113838.882	1106618.222		
9	Klotolde	—×	0.000	71.203	136.000						
10	Sirkelbue	×—×	259.765	6.826			Kort	113849.195	1106602.175	113819.932	1106671.678

Figur 97 Horizontal alignment, input data, FV44

7.2. Vertical geometry

H.O.H.
50

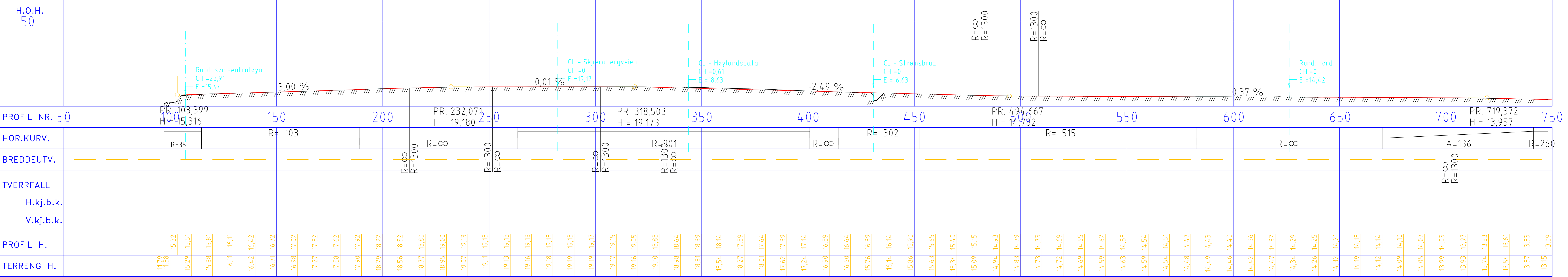

7.3. Vegoverflater

FV44	
☐	Venstre side
...	Avgrensninger
☐	Kjørebane
...	-1.01 V. Kollektivfelt
☐	Skulder
...	-2.01 V. Skulder 1
...	-2.08 V.Kantsteinsvis 1
...	-2.09 V.Kantsteinsflate 1
...	-2.18 V. Kantsteinsvis 2
...	-2.19 V. Skulder 2
☐	Tilleggsflater
...	-3.02 V.Kjørefelt 1
...	-3.03 V.Skulder 3
...	-3.04 V.Kjørefelt 2
...	-3.05 V.Skulder 4
...	-3.06 V.Sykkelfelt
...	-3.07 V.Kantsteinsvis 3
...	-3.08 V.Kantsteinsflate 2
...	-3.15 V. Fortau
☒	Grøft
☒	Fjellskjæring
☒	Jordskjæring
☒	Fylling
☐	Høyre side
...	Avgrensninger
☐	Kjørebane
...	1.01 H. Kollektivfelt
☐	Skulder
...	2.01 H. Skulder 1
...	2.18 H. Kantsteinsvis 1
...	2.19 H. Kantsteinsflate 1
☐	Tilleggsflater
...	3.02 H.Kantsteinsvis 2
...	3.03 H.Skulder 2
...	3.04 H.Kjørefelt 1
...	3.05 H.Skulder 3
...	3.06 H.Sykkelfelt
...	3.07 H.Kantsteinsvis 3
...	3.08 H.Kantsteinsflate 2
...	3.15 H. Fortau
☒	Grøft
☒	Fjellskjæring
☒	Jordskjæring
☒	Fylling

Figur 98 All surfaces for FV44

7.3.1. Left side

	Profil	Flate	Linjeavgrensning	Avstand	Object
1	-99999.000	Primærlinje		0.000	
2	118.380	Primærlinje		0.000	
3	Brudd				
4	118.380	-3.08 V.Kantsteinsflate 2		0.000	
5	137.795	-3.08 V.Kantsteinsflate 2		0.000	
6	Brudd				
7	137.795	-3.15 V. Fortau		0.000	
8	617.481	-3.15 V. Fortau		0.000	
9	Brudd				
10	617.481	-2.01 V. Skulder 1		0.000	
11	657.863	-2.01 V. Skulder 1		0.000	
12	Brudd				
13	657.863	-3.15 V. Fortau		0.000	
14	99999.000	-3.15 V. Fortau		0.000	

Figur 99 Boundary, left, FV44

	Profil	Bredde	Helling	Metode	Linje	Fri flate
1	-99999.000	3.000	-0.030			
2	0.000			↕	avgr. rund. sør Kollektiv	-1.01 V. Kollektivfelt
3	139.148			↕	avgr. rund. sør Kollektiv	-1.01 V. Kollektivfelt
4	139.148			↕	avgr. venstre kollektiv sk	-1.01 V. Kollektivfelt
5	99999.000			↕	avgr. venstre kollektiv sk	-1.01 V. Kollektivfelt
6	99999.000	3.000	-0.030			

Figur 100 Kollektivfelt, left, FV44

	Profil	Bredde	Helling	Metode	Linje	Fri flate
1	-99999.000	0.250	Arv			
2	99999.000	0.250	Arv			

Figur 101 Skulder 1, left, FV44

	Profil	Bredde	Helling	Metode	Linje	Fri flate
1	-99999.000	0.000	13.000			
2	191.675	0.000	13.000			
3	Brudd					
4	191.675	0.010	13.000			
5	404.027	0.010	13.000			
6	Brudd					
7	404.027	0.000	0.000			
8	453.000	0.000	0.000			
9	Brudd					
10	453.000	0.010	13.000			
11	625.273	0.010	13.000			
12	99999.000	0.010	13.000			

Figur 102 Kantsteinsvis 1, left, FV44

	Profil	Bredde	Helling	Metode	Linje	Fri flate
1	-99999.000	0.000	0.000			
2	188.142	0.000	0.000			
3	188.142			↕	avgr. kjørebane venstre	-2.09 V.Kantsteinsflate 1
4	9999.000			↕	avgr. kjørebane venstre	-2.09 V.Kantsteinsflate 1

Figur 103 Kantsteinsflate 1, left, FV44

	Profil	Bredde	Helling	Metode	Linje	Fri flate
1	-99999.000	0.000	-13.000			
2	191.675	0.000	-13.000			
3	Brudd					
4	191.675	0.010	-13.000			
5	404.027	0.010	-13.000			
6	Brudd					
7	404.027	0.000	0.000			
8	453.000	0.000	0.000			
9	Brudd					
10	453.000	0.010	-13.000			
11	99999.000	0.010	-13.000			

Figur 104 Kantsteinsvis 2, left, FV44

	Profil	Bredde	Helling	Metode	Linje	Fri flate
1	-99999.000	0.000	-0.030			
2	179.407	0.000	-0.030			
3	186.190	0.250	-0.030			
4	99999.000	0.250	-0.030			

Figur 105 Skulder 2, left, FV44

	Profil	Bredde	Helling	Metode	Linje	Fri flate
1	-999.000	3.000	-0.030			
2	-999.000			↕	avgr. rund. sør FV44 til T	-3.02 V.Kjørefelt 1
3	193.372			↕	avgr. rund. sør FV44 til T	-3.02 V.Kjørefelt 1
4	193.372			↕	avgr. venstre kjørebane	-3.02 V.Kjørefelt 1
5	999.000			↕	avgr. venstre kjørebane	-3.02 V.Kjørefelt 1
6	999.000	3.000	-0.030			

Figur 106 Kjørefelt 1, left, FV44

	Profil	Bredde	Helling	Metode	Linje	Fri flate
1	-99999.000	0.250	Arv			
2	191.645	0.250	Arv			
3	196.909	0.000	Arv			
4	99999.000	0.000	Arv			

Figur 107 Skulder 3, left, FV44

	Profil	Bredde	Helling	Metode	Linje	Fri flate
1	-99999.000	3.000	-0.030			
2	-999.000			↕	avgr. rund. sør Tunnelen	-3.04 V.Kjørefelt 2
3	193.372			↕	avgr. rund. sør Tunnelen	-3.04 V.Kjørefelt 2
4	193.372	0.000	-0.030			
5	999.000	0.000	-0.030			

Figur 108 Kjørefelt 2, left, FV44

	Profil	Bredde	Helling	Metode	Linje	Fri flate
1	-99999.000	0.250	Arv			
2	99999.000	0.250	Arv			

Figur 109 Skulder 4, left, FV44

	Profil	Bredde	Helling	Metode	Linje	Fri flate
1	-99999.000	2.000	-0.030			
2	-99999.000			↕	avgr. sykkel venstre a	-3.06 V.Sykkelfelt
3	80.339			↕	avgr. sykkel venstre a	-3.06 V.Sykkelfelt
4	80.339	0.000	0.000			
5	184.851	0.000	0.000			
6	184.851			↕	avgr. sykkel venstre b	-3.06 V.Sykkelfelt
7	99999.000			↕	avgr. sykkel venstre b	-3.06 V.Sykkelfelt
8	99999.000	2.000	-0.030			

Figur 110 Sykkelfelt, left, FV44

	Profil	Bredde	Helling	Metode	Linje	Fri flate
1	-99999.000	0.010	13.000			
2	335.236	0.010	13.000			
3	335.736	0.002	13.000			
4	358.894	0.002	13.000			
5	359.394	0.010	13.000			
6	99999.000	0.010	13.000			

Figur 111 Kantsteinsvis 3, left, FV44

	Profil	Bredde	Helling	Metode	Linje	Fri flate
1	-99999.000	0.090	0.000			
2	99999.000	0.090	0.000			

Figur 112 Kantsteinsflate 2, left, FV44

	Profil	Bredde	Helling	Metode	Linje	Fri flate
1	-99999.000	2.900	0.020			
2	-99999.000			↘	avgr. fortau venstre a	-3.15 V. Fortau
3	77.517			↘	avgr. fortau venstre a	-3.15 V. Fortau
4	77.517	0.000	0.020			
5	137.795	0.000	0.020			
6	137.795			↘	avgr. fortau venstre b	-3.15 V. Fortau
7	612.513			↘	avgr. fortau venstre b	-3.15 V. Fortau
8	612.513			↘	rund. nor. v fortau	-3.15 V. Fortau
9	661.399			↘	rund. nor. v fortau	-3.15 V. Fortau
10	661.399			↘	avgr. fortau venstre b	-3.15 V. Fortau
11	99999.000			↘	avgr. fortau venstre b	-3.15 V. Fortau
12	99999.000	2.900	0.020			

Figur 113 Fortau, left, FV44

7.3.2. Right side

	Profil	Flate	Linjeavgrensning	Avstand	Object
1	-99999.000	Primær linje		0.000	
2	118.380	Primær linje		0.000	
3	Brudd				
4	118.380	3.15 H. Fortau		0.000	
5	418.543	3.15 H. Fortau		0.000	
6	Brudd				
7	418.543		avgr. FV44 T kryss h.	0.000	
8	443.413		avgr. FV44 T kryss h.	0.000	
9	Brudd				
10	443.413	3.15 H. Fortau		0.000	
11	617.481	3.15 H. Fortau		0.000	
12	Brudd				
13	617.481	2.01 H. Skulder 1		0.000	
14	657.863	2.01 H. Skulder 1		0.000	
15	Brudd				
16	657.863	3.15 H. Fortau		0.000	
17	99999.000	3.15 H. Fortau		0.000	

Figur 114 Boundary, right, FV44

	Profil	Bredde	Helling	Metode	Linje	Fri flate
1	-99999.000	3.000	-0.030			
2	-99999.000			↘	avgr. høyre kollektiv skul	1.01 H. Kollektivfelt
3	99999.000			↘	avgr. høyre kollektiv skul	1.01 H. Kollektivfelt
4	99999.000	3.000	-0.030			

Figur 115 Kollektivfelt, right, FV44

	Profil	Bredde	Helling	Metode	Linje	Fri flate
1	-99999.000	0.250	Arv			
2	99999.000	0.250	Arv			

Figur 116 Skulder 1, right, FV44

	Profil	Bredde	Helling	Metode	Linje	Fri flate
1	-99999.000	0.010	13.000			
2	23.085	0.010	13.000			
3	Brudd					
4	23.085	0.000	0.000			
5	182.964	0.000	0.000			
6	Brudd					
7	182.964	0.010	13.000			
8	404.027	0.010	13.000			
9	Brudd					
10	404.027	0.000	0.000			
11	453.000	0.000	0.000			
12	Brudd					
13	453.000	0.010	13.000			
14	621.016	0.010	13.000			
15	Brudd					
16	661.399	0.010	13.000			
17	99999.000	0.010	13.000			

Figur 117 Kantsteinsvis 1, right, FV44

	Profil	Bredde	Helling	Metode	Linje	Fri flate
1	-99999.000	0.090	0.000			
2	-99999.000			↘	avgr. kjørebane høyre 2	2.19 H. Kantsteinsflate 2
3	67.380			↘	avgr. kjørebane høyre 2	2.19 H. Kantsteinsflate 2
4	67.380	0.000	0.000			
5	174.349	0.000	0.000			
6	Brudd					
7	174.349			↘	avgr. kjørebane høyre 2	2.19 H. Kantsteinsflate 2
8	621.016			↘	avgr. kjørebane høyre 2	2.19 H. Kantsteinsflate 2
9	661.399			↘	avgr. kjørebane høyre 2	2.19 H. Kantsteinsflate 2
10	9999.000			↘	avgr. kjørebane høyre 2	2.19 H. Kantsteinsflate 2

Figur 118 Kantsteinsflate 1, right, FV44

	Profil	Bredde	Helling	Metode	Linje	Fri flate
1	-99999.000	0.010	-13.000			
2	23.085	0.010	-13.000			
3	Brudd					
4	23.085	0.000	0.000			
5	182.964	0.000	0.000			
6	Brudd					
7	182.964	0.010	-13.000			
8	404.027	0.010	-13.000			
9	Brudd					
10	404.027	0.000	0.000			
11	453.000	0.000	0.000			
12	Brudd					
13	453.000	0.010	-13.000			
14	621.016	0.010	-13.000			
15	Brudd					
16	661.399	0.010	-13.000			
17	99999.000	0.010	-13.000			

Figur 119 Kantsteinsvis 2, right, FV44

	Profil	Bredde	Helling	Metode	Linje	Fri flate
1	-99999.000	0.000	-0.030			
2	173.860	0.000	-0.030			
3	179.421	0.250	-0.030			
4	99999.000	0.250	-0.030			

Figur 120 Skulder 2, right, FV44

	Profil	Bredde	Helling	Metode	Linje	Fri flate
1	-99999.000	3.000	-0.030			
2	0.000			↕		
3	139.148			↕	avgr. rund. sør FV44 til r	3.04 H.Kjørefelt 1
4	139.148			↕	avgr. rund. sør FV44 til r	3.04 H.Kjørefelt 1
5	99999.000			↕	avgr. høyre kjørebane sk	3.04 H.Kjørefelt 1
6	99999.000	3.000	-0.030			

Figur 121 Kjørefelt 1, right, FV44

	Profil	Bredde	Helling	Metode	Linje	Fri flate
1	-99999.000	0.250	Arv			
2	99999.000	0.250	Arv			

Figur 122 Skulder 3, right, FV44

	Profil	Bredde	Helling	Metode	Linje	Fri flate
1	-99999.000	2.000	-0.030			
2	-99999.000			↕	avgr. sykkel høyre	3.06 H.Sykkelfelt
3	139.148			↕	avgr. sykkel høyre	3.06 H.Sykkelfelt
4	139.148			↕	avgr. sykkel høyre	3.06 H.Sykkelfelt
5	99999.000			↕	avgr. sykkel høyre	3.06 H.Sykkelfelt
6	99999.000	2.000	-0.030			

Figur 123 Sykkelfelt, right, FV44

	Profil	Bredde	Helling	Metode	Linje	Fri flate
1	-99999.000	0.010	13.000			
2	280.148	0.010	13.000			
3	280.648	0.002	13.000			
4	290.164	0.002	13.000			
5	290.664	0.010	13.000			
6	99999.000	0.010	13.000			

Figur 124 Kantsteinsvis 3, right, FV44

	Profil	Bredde	Helling	Metode	Linje	Fri flate
1	-99999.000	0.090	0.000			
2	99999.000	0.090	0.000			

Figur 125 Kantsteinsflate 2, right, FV44

	Profil	Bredde	Helling	Metode	Linje	Fri flate
1	-99999.000	2.000	0.020			
2	-99999.000			↕	avgr. fortau høyre	3.15 H. Fortau
3	99999.000			↕	avgr. fortau høyre	3.15 H. Fortau
4	99999.000	2.000	0.020			

Figur 126 Fortau, right, FV44

8. Strømsbrua (brua)

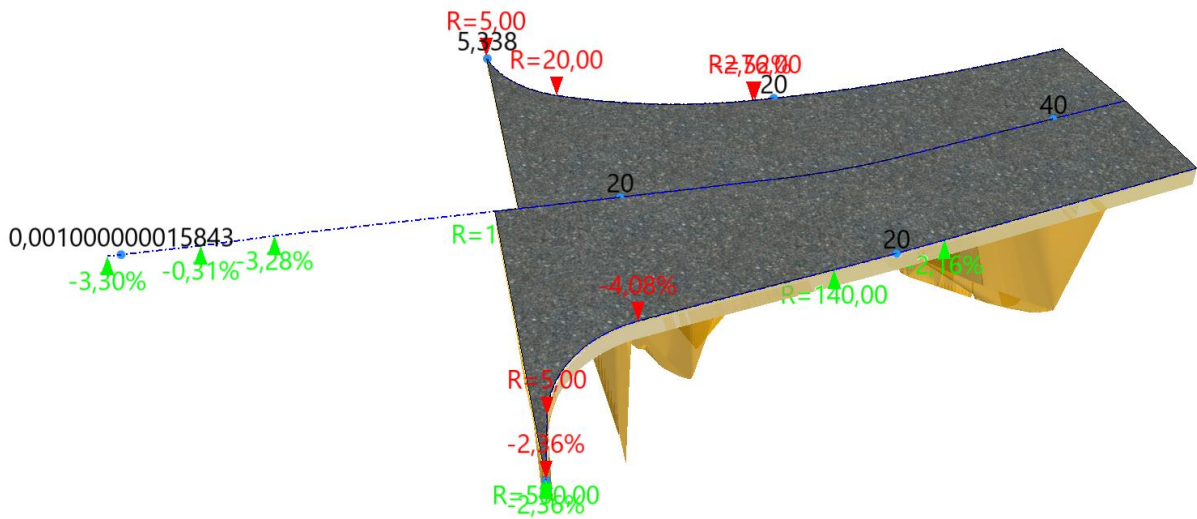

Figur 127 Strømsbrua (view from south)

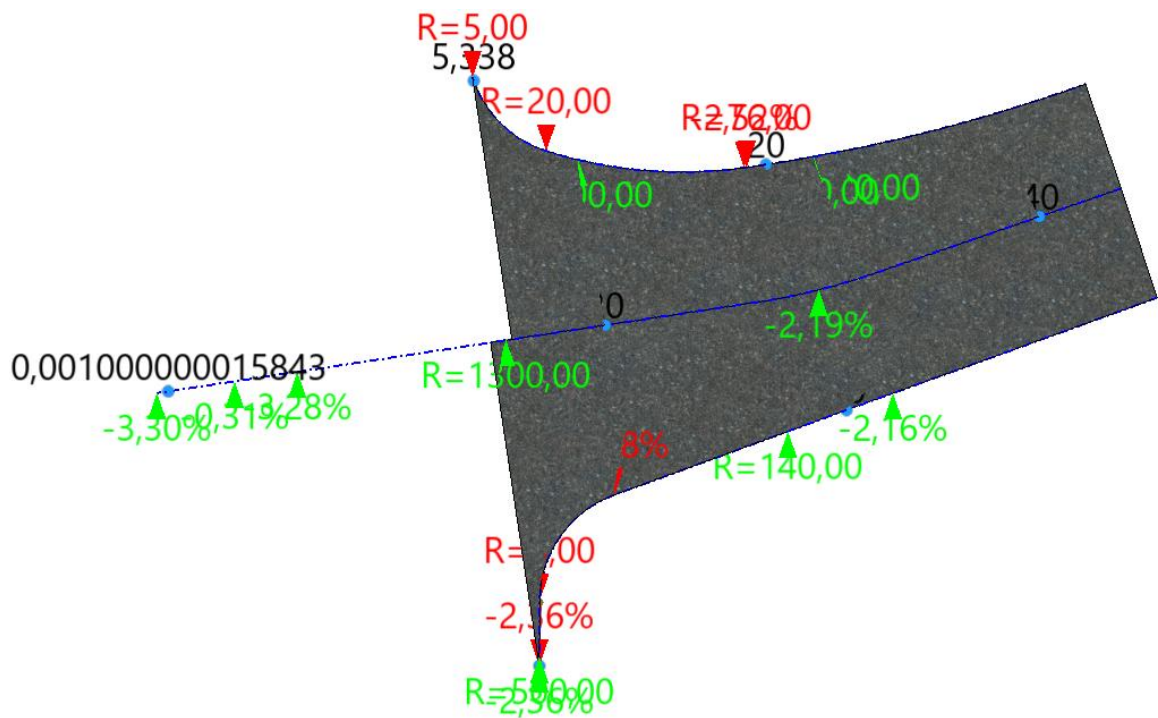

Figur 128 Strømsbrua (view from top)

8.1. Horizontal geometry

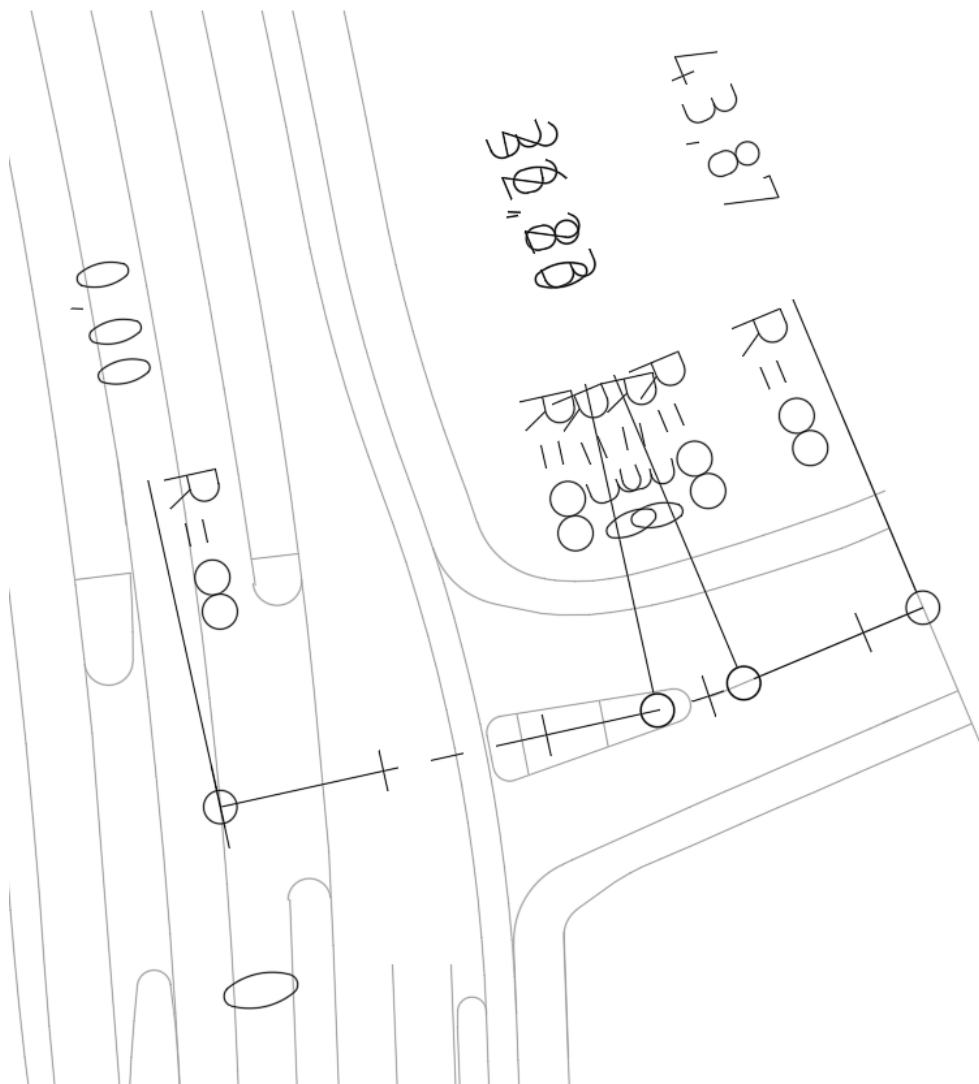

Figur 129 Horizontal alignment, Strømsbrua

Nr.	Elementtype	Innspenning	Radius	Lengde	Param.	Retning	Buetype	Øst1	Nord1	Øst2	Nord2
1	Rettlinje	×—×		26.799		0.217		113922.736	1106372.555	113947.080	1106377.933
2	Sirkelbue	—×	-30.000	5.435			Kort	113954.206	1106380.037		
3	Rettlinje	—×		11.632		0.000		113964.796	1106384.496		

Figur 130 horizontal alignment, input data, Strømsbrua

8.2. Vertical geometry

H50.H.

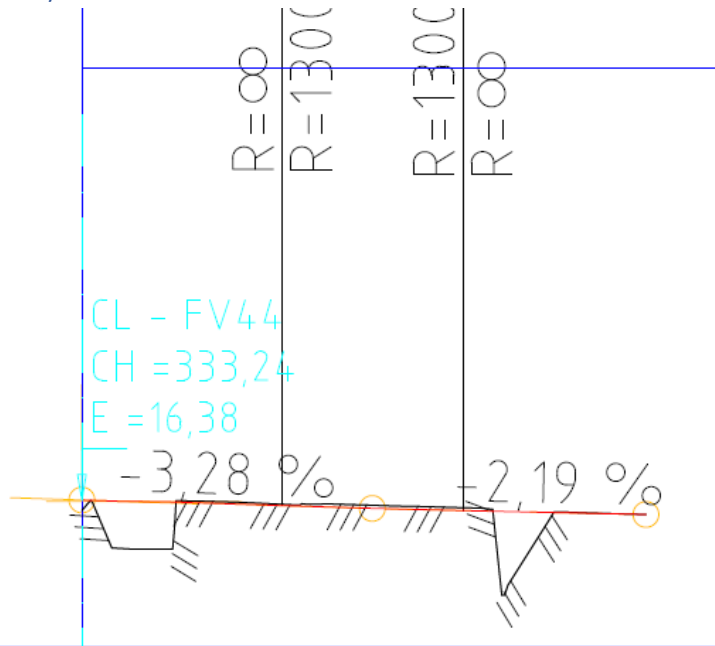

PROFIL NR.	PR. 0 H = 16,39	PR. 22,590 H = 15,732	PR. 43,865 H = 15,266
------------	--------------------	--------------------------	--------------------------

HOR.KURV.	R = ∞	R = -30	R = ∞
-----------	-------	---------	-------

BREDDEUTV.	_____	_____	_____
------------	-------	-------	-------

TVERRFALL	_____	_____	_____
— H.kj.b.k.	_____	_____	_____
- - - V.kj.b.k.	_____	_____	_____

PROFIL H.	16,39	16,14	15,82	15,57	15,35	15,27
TERRENG H.	15,58	16,29	16,07	15,78	15,37	15,27

Strømsbrua

Figur 131 Vertical alignment, Strømsbrua

8.3. Vegoverflater

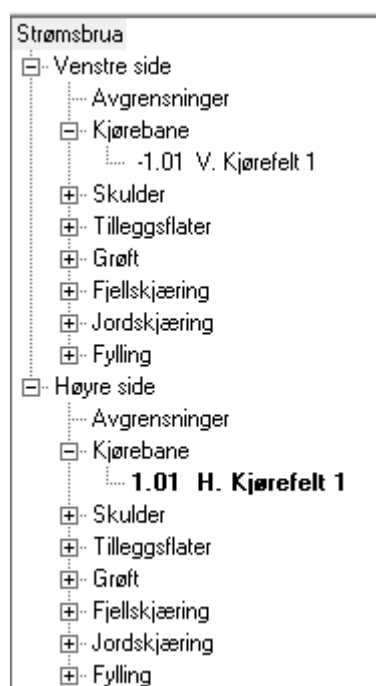

Figur 132 All layer for Strømsbrua

8.3.1. Left side

	Profil	Flate	Linjeavgrensning	Avstand	Object
1	-99.000	Primærlinje		0.000	
2	15.825	Primærlinje		0.000	
3	Brudd				
4	15.825	-1.01 V. Kjørefelt 1		0.000	
5	99.000	-1.01 V. Kjørefelt 1		0.000	

Figur 133 Boundary, left, brua

	Profil	Bredden	Helling	Metode	Linje	Fri flate
1	-99999.000	7.000	-0.030			
2	-99.000			↕	avgr. Strømsbrua ut	-1.01 V. Kjørefelt 1
3	99.000			↕	avgr. Strømsbrua ut	-1.01 V. Kjørefelt 1
4	99999.000	7.000	-0.030			

Figur 134 Kjørefelt 1, left, brua

8.3.2. Right side

	Profil	Flate	Linjeavgrensning	Avstand	Object
1	-99.000	Primærlinje		0.000	
2	14.874	Primærlinje		0.000	
3	Brudd				
4	14.874	1.01 H. Kjørefelt 1		0.000	
5	999.000	1.01 H. Kjørefelt 1		0.000	

Figur 135 Boundary, right, brua

	Profil	Bredde	Helling	Metode	Linje	Fri flate
1	-99999.000	3.000	-0.030			
2	14.874			↕	avgr. Strømsbrua in	1.01 H. Kjørefelt 1
3	43.878			↕	avgr. Strømsbrua in	1.01 H. Kjørefelt 1
4	99999.000	3.000	-0.030			

Figur 136 Kjørefelt 1, right, brua

9. Strømsbrua in forttau (Sif)

Road task Strømsbrua in forttau is based on line task avgr. Strømsbrua in. Line task avgr. Strømsbrua in forttau is for boundary of sidewalk. Last line is not visible on model since it has only horizontal geometry.

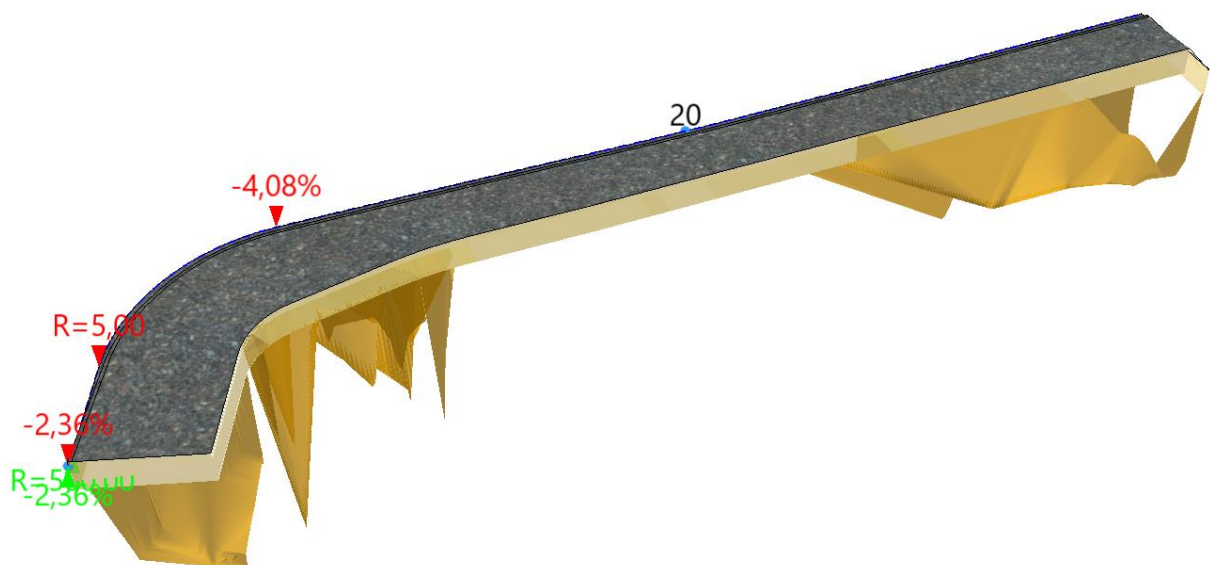

Figur 137 Strømsbrua in forttau (view from south)

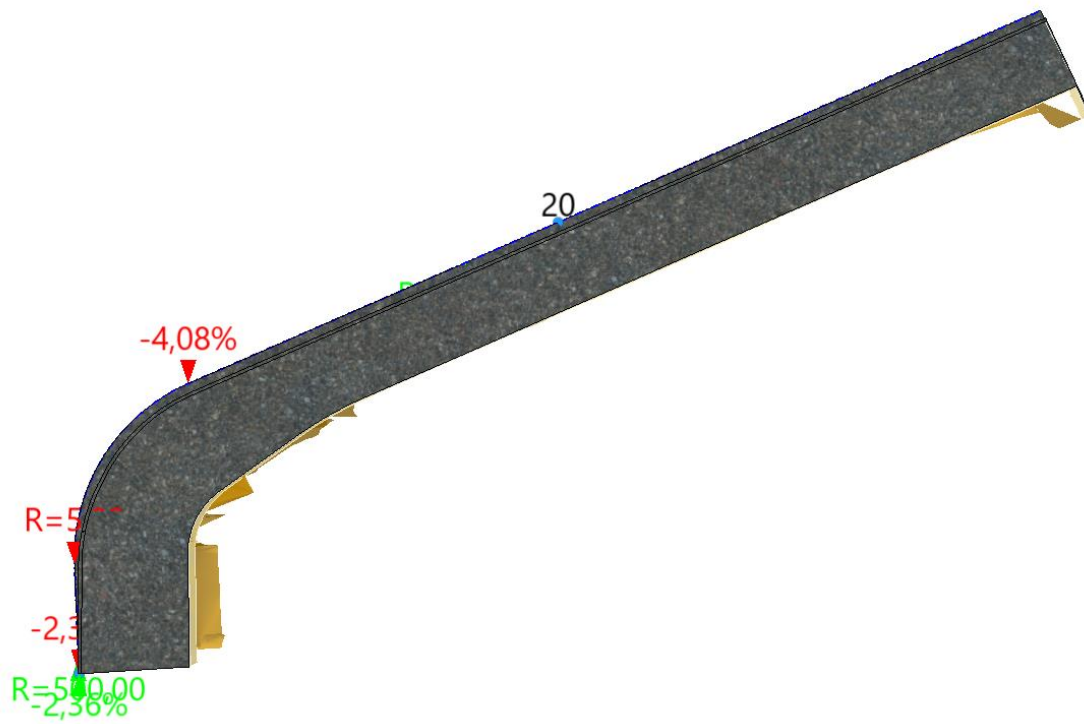

Figur 138 Strømsbrua in fortau (view from top)

9.1. Horizontal geometry

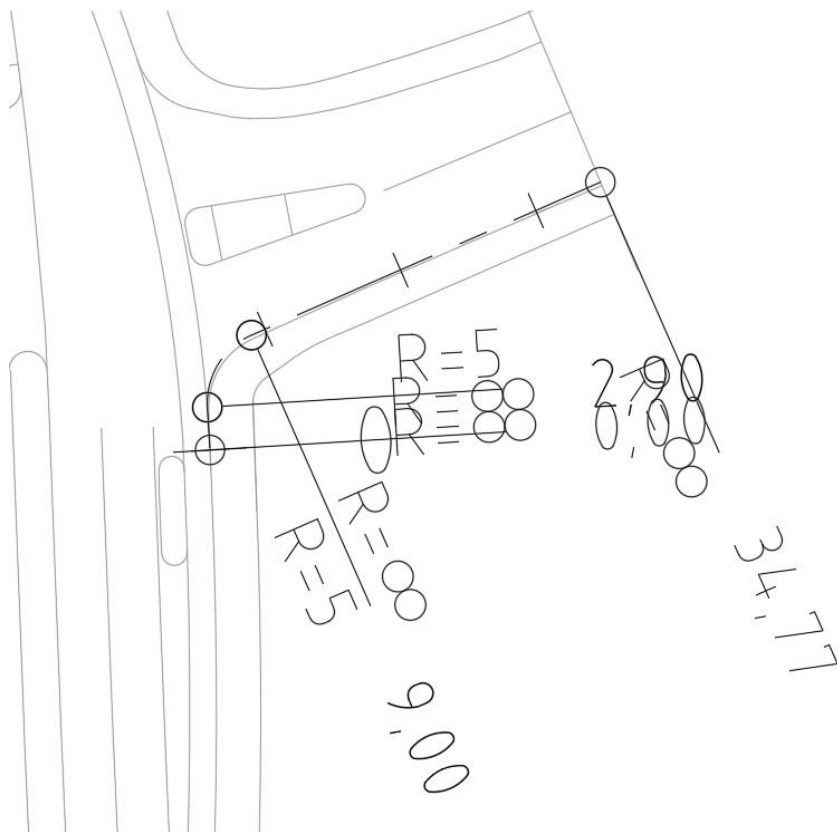

Figur 139 Horizontal alignment, Strømsbrua in

1	Rettlinje	×-×		2.905		1.632		113940.389	1106361.599	113940.279	1106363.402
2	Sirkelbue	==×	5.000	6.092			Kort	113942.832	1106369.206		
3	Rettlinje	==×		25.778		0.000		113966.797	1106379.742		

Figur 140 Horizontal alignment, input data, Strømsbrua in

9.2. Vertical geometry

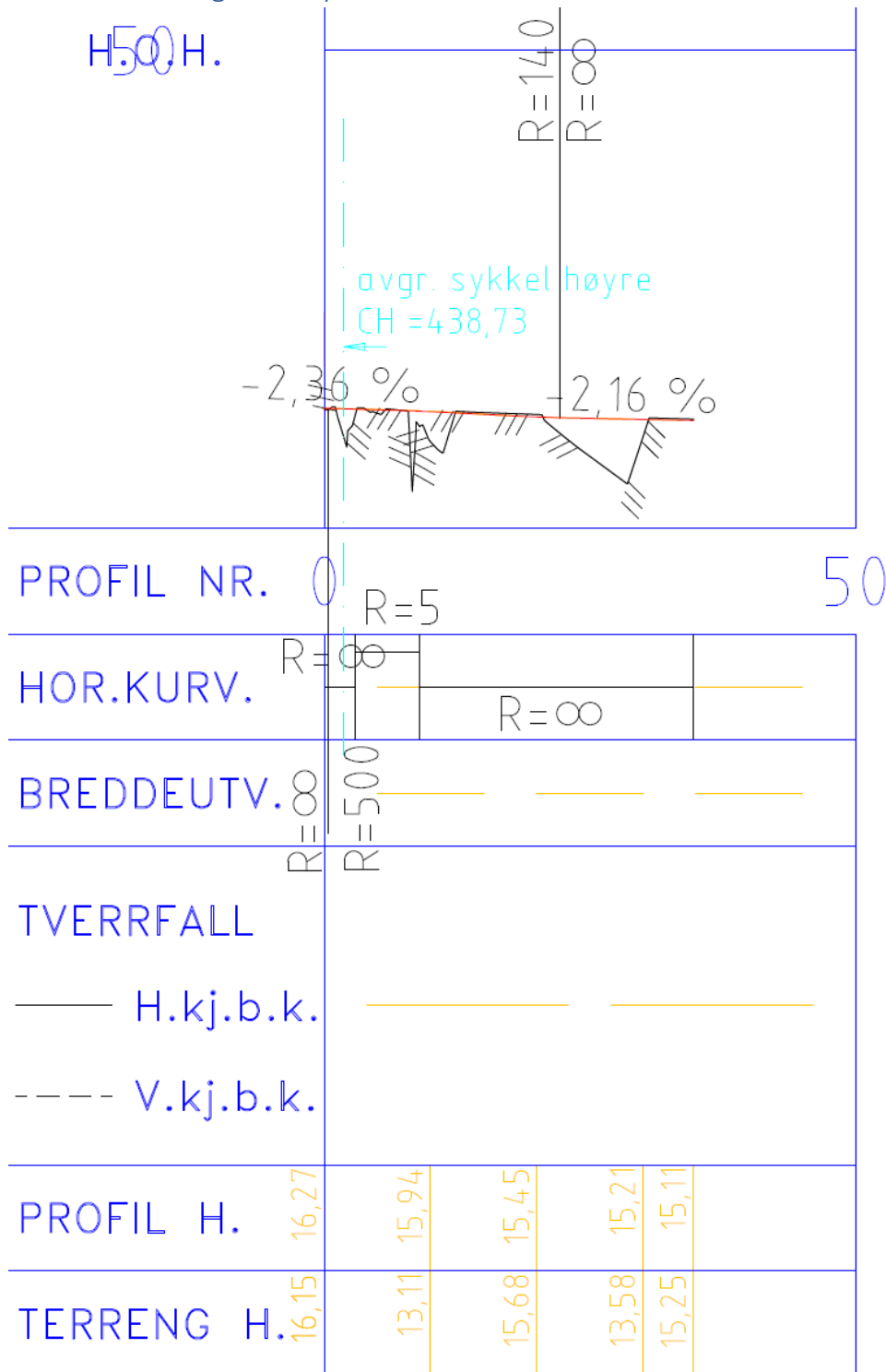

avgr. Strømsbrua in

Figur 141 Vertical alignment, avgr. Strømsbrua in

9.3. Vegoverflater

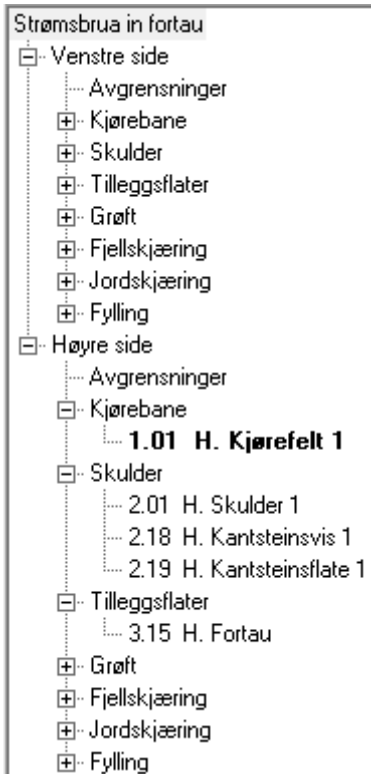

Figur 142 All surfaces for Strømsbrua in fortau

9.3.1. Left side

	Profil	Flate	Linjeavgrensning	Avstand	Object
1	-99.000	Primærlinje		0.000	
2	99.000	Primærlinje		0.000	

Figur 143 Boundary, left, Sif.

9.3.2. Right side

	Profil	Flate	Linjeavgrensning	Avstand	Object
1	-99.000	3.15 H. Fortau		0.000	
2	99.000	3.15 H. Fortau		0.000	

Figur 144 Boundary, right, Sif.

	Profil	Bredde	Helling	Metode	Linje	Fri flate
1	-99999.000	0.000	-0.030			
2	99999.000	0.000	-0.030			

Figur 145 Kjørefelt 1, right, Sif.

	Profil	Bredde	Helling	Metode	Linje	Fri flate
1	-99999.000	0.000	-0.030			
2	0.000	0.000	-0.030			
3	5.375	0.250	-0.030			
4	99999.000	0.250	-0.030			

Figur 146 Skulder 1, right, Sif.

	Profil	Bredde	Helling	Metode	Linje	Fri flate
1	-99999.000	0.010	13.000			
2	99999.000	0.010	13.000			

Figur 147 Kantsteinsvis 1, right, Sif.

	Profil	Bredde	Helling	Metode	Linje	Fri flate
1	-99999.000	0.090	0.000			
2	99999.000	0.090	0.000			

Figur 148 Kantsteinsflate 1, right, Sif.

	Profil	Bredde	Helling	Metode	Linje	Fri flate
1	-99999.000	2.900	0.020			
2	-99.000			↕	avgr. Strømsbrua in fortau	3.15 H. Fortau
3	99.000			↕	avgr. Strømsbrua in fortau	3.15 H. Fortau
4	99999.000	2.900	0.020			

Figur 149 Fortau, right, Sif.

10. Strømsbrua ut fortau (Suf.)

Road task Strømsbrua ut fortau is based on line task avgr. Strømsbrua ut. Line task avgr. Strømsbrua ut fortau is for boundary of sidewalk. Last line is not visible on model since it has only horizontal geometry.

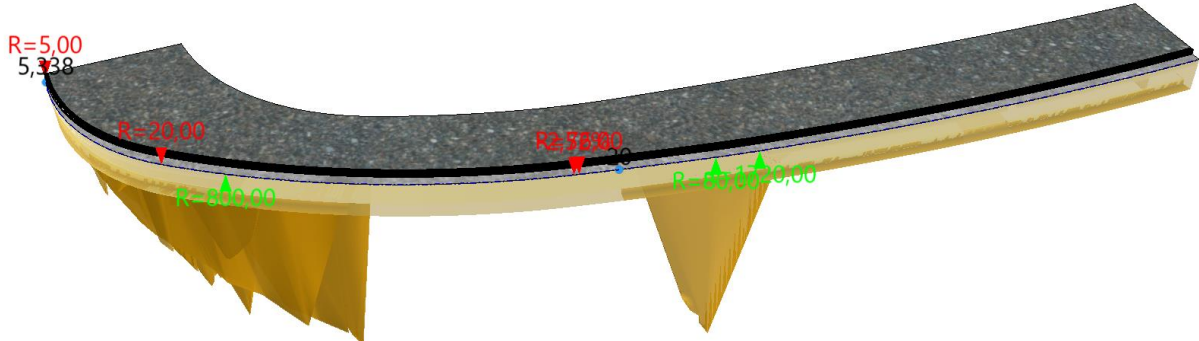

Figur 150 Strømsbrua ut fortau (view from south)

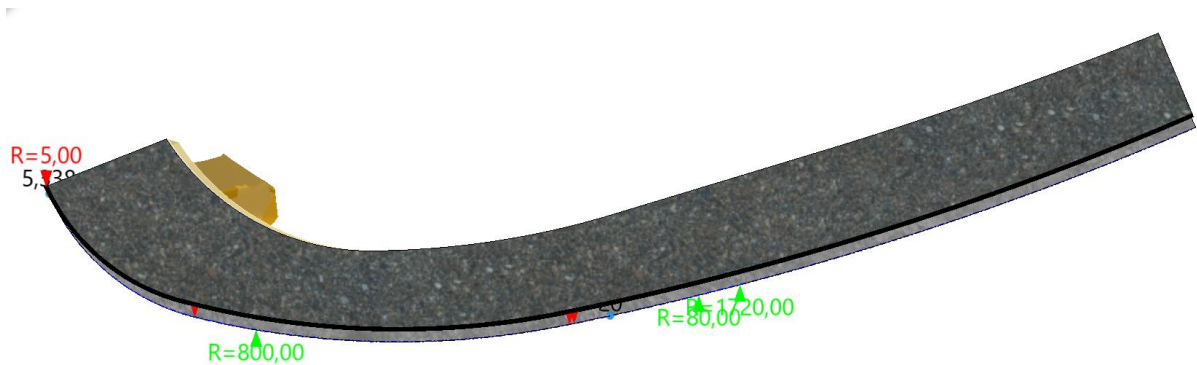

Figur 151 Strømsbrua ut fortau (view from top)

10.1. Horizontal geometry

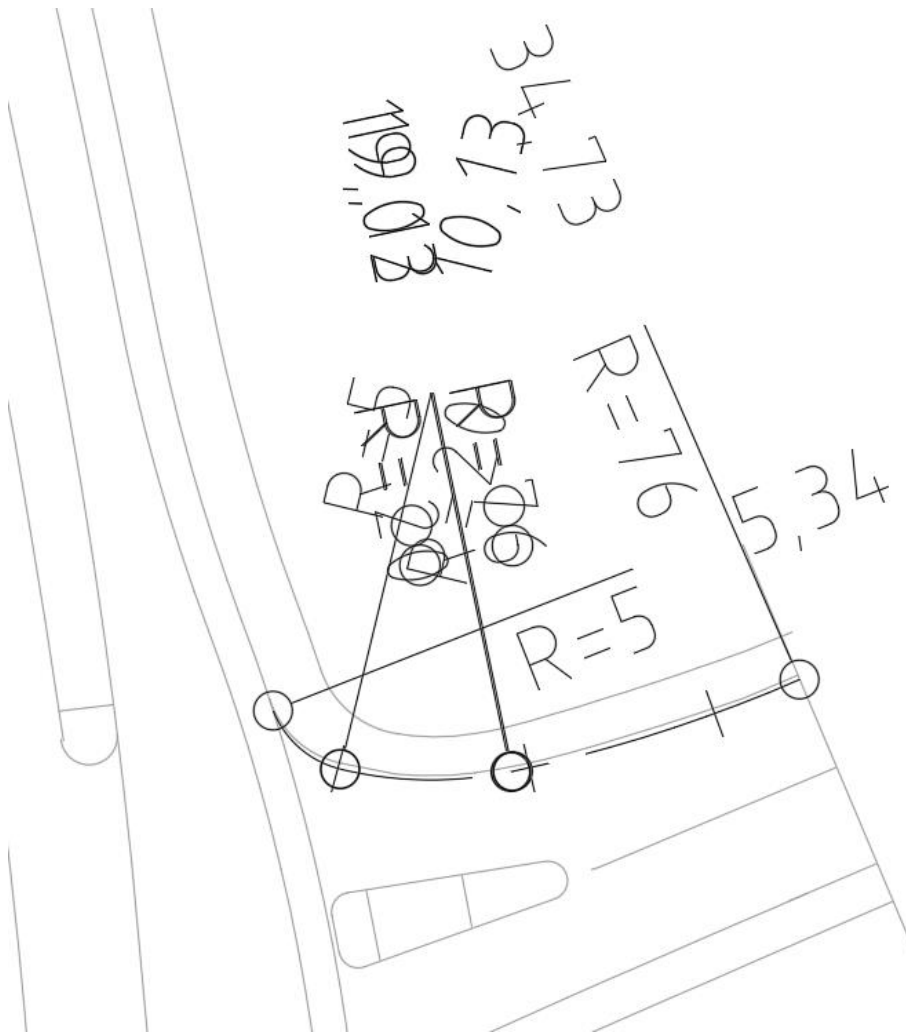

Figur 152 Horizontal alignment, Strømsbrua ut

Nr.	Elementtype	Innspenning	Radius	Lengde	Param.	Retning	Buetype	Øst1	Nord1	Øst2	Nord2
1	Sirkelbue	×—×	-5.000	4.791			Kort	113935.658	1106387.423	113940.106	1106384.259
2	Sirkelbue	—×	-20.000	8.889			Kort	113946.376	1106383.995		
3	Rettlinj	—×		0.111		0.000		113949.122	1106384.507		
4	Sirkelbue	—×	-76.000	15.600			Kort	113962.890	1106389.028		

Figur 153 Horizontal alignment, input data, Strømsbrua ut

10.2. Vertical geometry

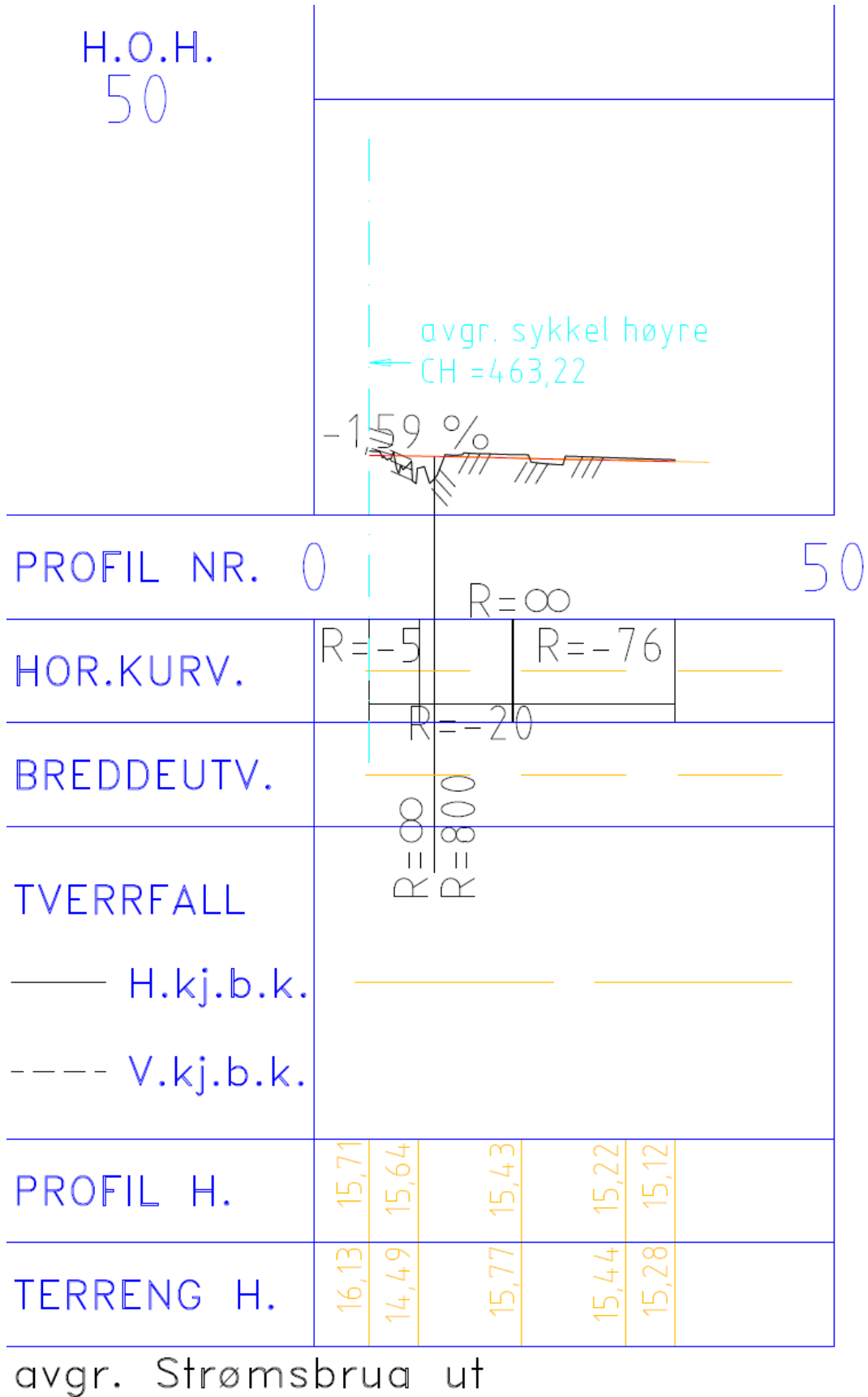

Figur 154 Vertical alignment, Strømsbrua ut

10.3. Vegoverflater

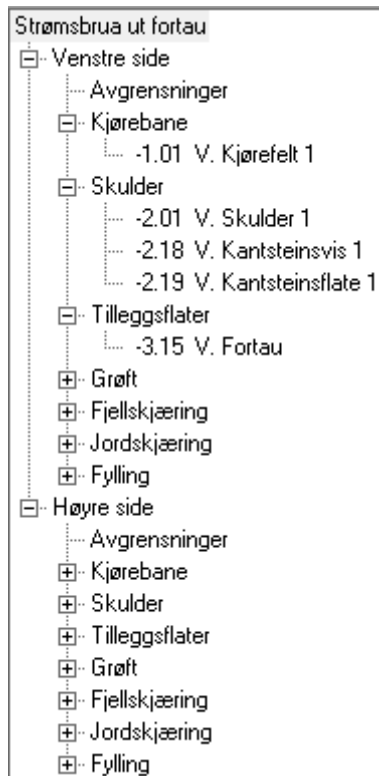

Figur 155 All surfaces of Strømsbrua ut fortau

10.3.1. Left side

	Profil	Flate	Linjeavgrensning	Avstand	Object
1	-99.000	-3.15 V. Fortau		0.000	
2	99.000	-3.15 V. Fortau		0.000	

Figur 156 Boundary, left, Suf.

	Profil	Bredde	Helling	Metode	Linje	Fri flate
1	-99999.000	0.000	-0.030			
2	99999.000	0.000	-0.030			

Figur 157 Kjørefelt 1, left, Suf.

	Profil	Bredde	Helling	Metode	Linje	Fri flate
1	-99999.000	0.000	-0.030			
2	5.338	0.000	-0.030			
3	10.000	0.250	-0.030			
4	99999.000	0.250	-0.030			

Figur 158 Skulder 1, left, Suf.

	Profil	Bredde	Helling	Metode	Linje	Fri flate
1	-99999.000	0.010	13.000			
2	99999.000	0.010	13.000			

Figur 159 Kantsteinsvis 1, left, Suf.

	Profil	Bredde	Helling	Metode	Linje	Fri flate
1	-99999.000	0.090	0.000			
2	99999.000	0.090	0.000			

Figur 160 Kantsteinsflate 1, left, Suf.

	Profil	Bredde	Helling	Metode	Linje	Fri flate
1	-99999.000	2.900	0.020			
2	-99.000			↙	avgr. Strømsbrua ut forta	-3.15 V. Fortau
3	99.000			↘	avgr. Strømsbrua ut forta	-3.15 V. Fortau
4	99999.000	2.900	0.020			

Figur 161 Fortau, left, Suf.

10.3.2. Right side

	Profil	Flate	Linjeavgrensning	Avstand	Object
1	-99.000	Primærlinje		0.000	
2	99.000	Primærlinje		0.000	

Figur 162 Boundary, right, Suf.

11. Strømsbrua trafikkøya (St.)

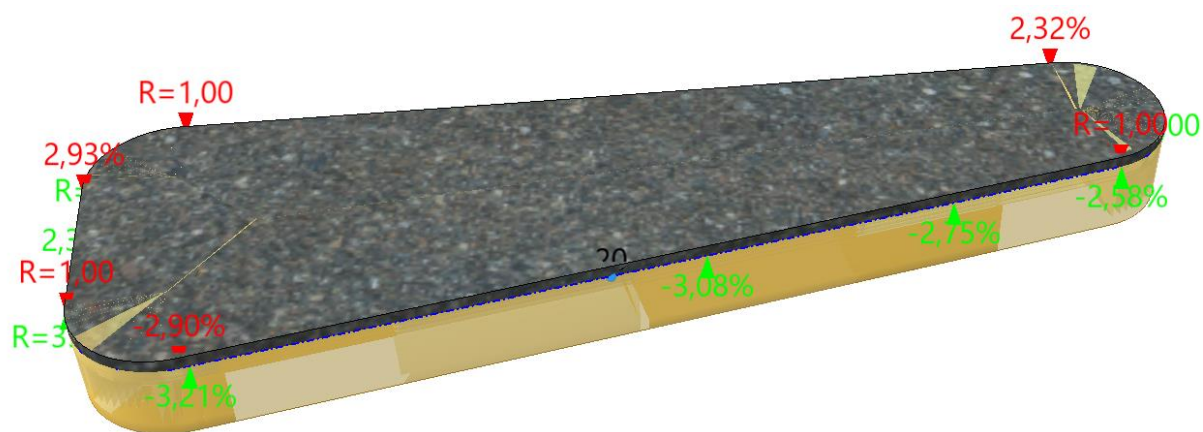

Figur 163 Strømsbrua trafikkøya (view from south)

Nr.	Elementtype	Innspenning	Radius	Lengde	Param.	Retning	Buetype	Øst1	Nord1	Øst2	Nord2
1	Rettlinje	↔↔↔		10.332		3.299		113949.721	1106379.615	113939.512	1106377.995
2	Sirkelbue	↔↔↔	-1.000	1.607			Kort	113938.693	1106376.810		
3	Rettlinje	↔↔↔		1.938		0.000		113939.063	1106374.927		
4	Sirkelbue	↔↔↔	-1.000	1.720			Kort	113940.385	1106374.166		
5	Rettlinje	↔↔↔		10.483		0.000		113950.214	1106377.679		
6	Sirkelbue	↔↔↔	-1.000	2.997			Kort	113949.721	1106379.615		

Figur 166 Horizontal alignment, input data, Strømsbrua trafikkøya

11.2. Vertical geometry

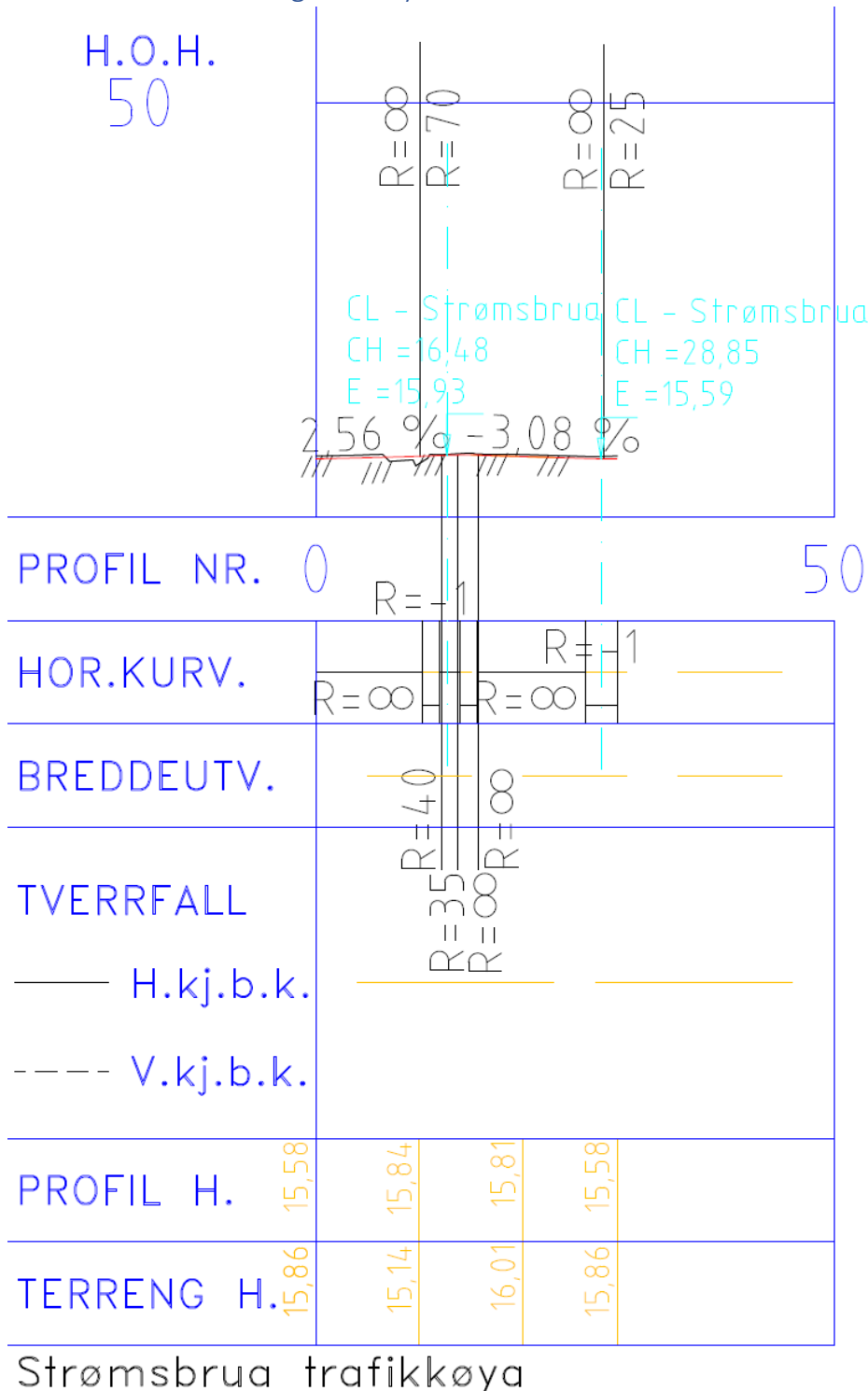

Figur 167 Vertical alignment, Strømsbrua trafikkøya

11.3. Vegoverflater

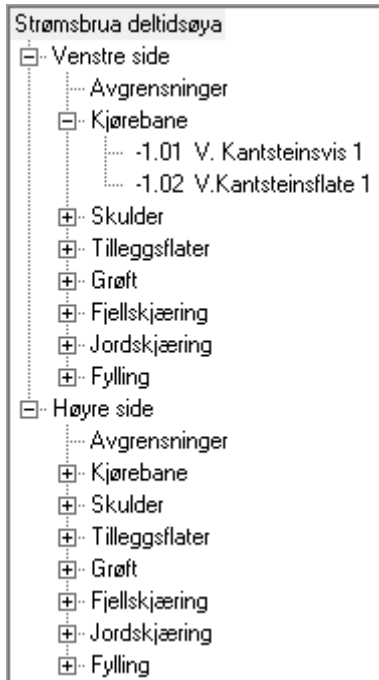

Figur 168 All surfaces for Strømsbrua trafikkøya

11.3.1. Left side

	Profil	Flate	Linjeavgrensning	Avstand	Object
1	-99.000	-1.02 V.Kantsteinsflate 1		0.000	
2	99.000	-1.02 V.Kantsteinsflate 1		0.000	

Figur 169 Boundary, left, St.

	Profil	Bredde	Helling	Metode	Linje	Fri flate
1	-99999.000	0.010	13.000			
2	99999.000	0.010	13.000			

Figur 170 Kantsteinsvis 1, left, St.

	Profil	Bredde	Helling	Metode	Linje	Fri flate
1	-99.000	2.000	0.000			
2	99.000	2.000	0.000			

Figur 171 Kantsteinsflate, left, St.

11.3.2. Right side

	Profil	Flate	Linjeavgrensning	Avstand	Object
1	-99.000	Primærlinje		0.000	
2	99.000	Primærlinje		0.000	

Figur 172 Boundary, right, St.

12. Skjærebergveien (Skj.)

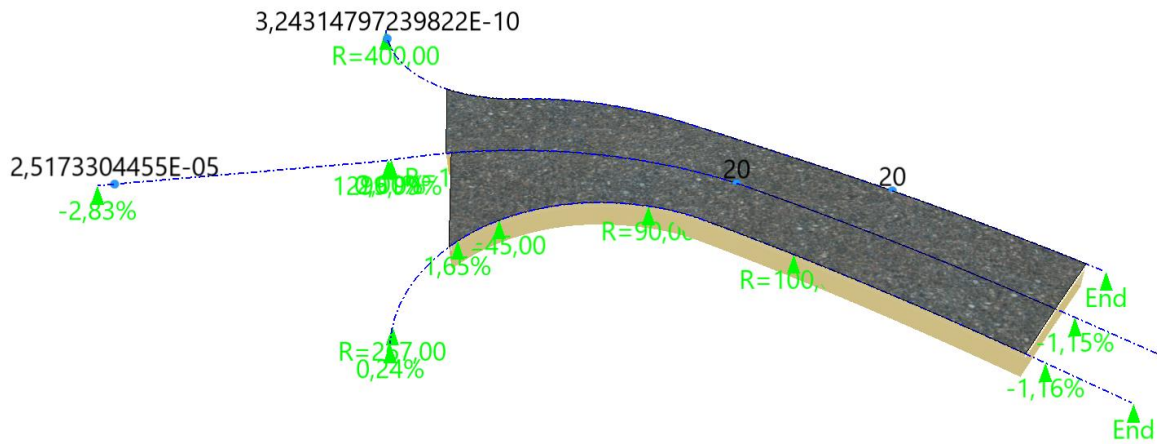

Figur 173 Skjærebergveien (view from south)

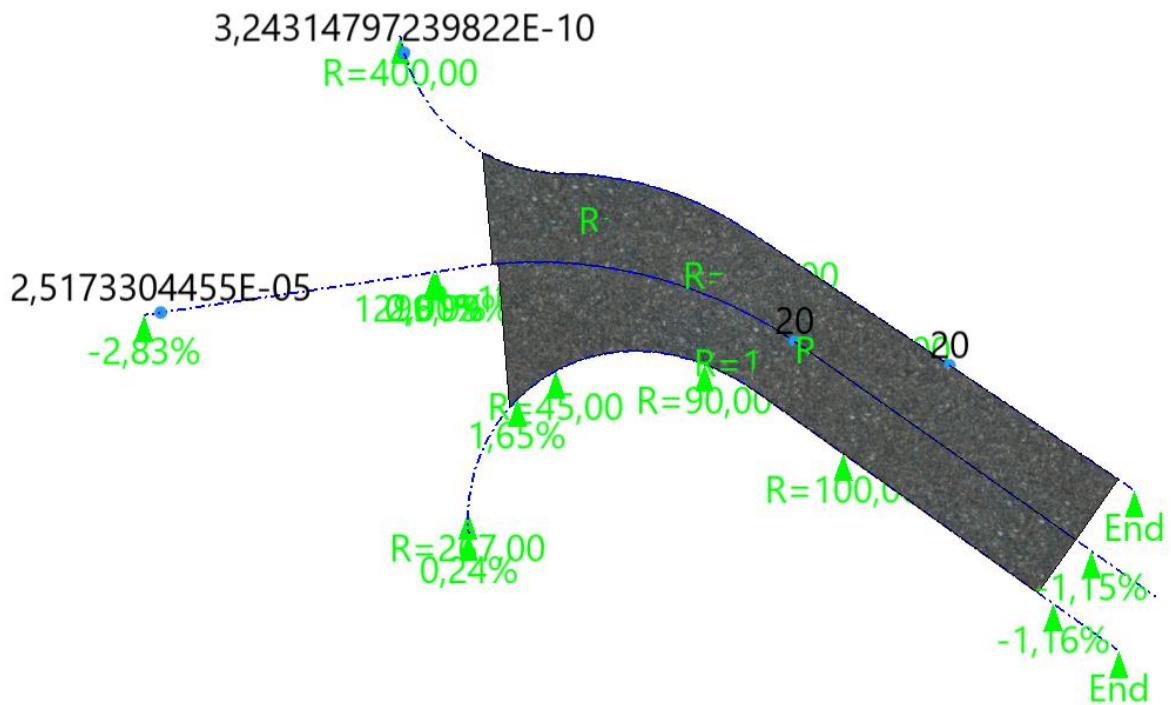

Figur 174 Skjærebergveien (view from top)

12.1. Horizontal geometry

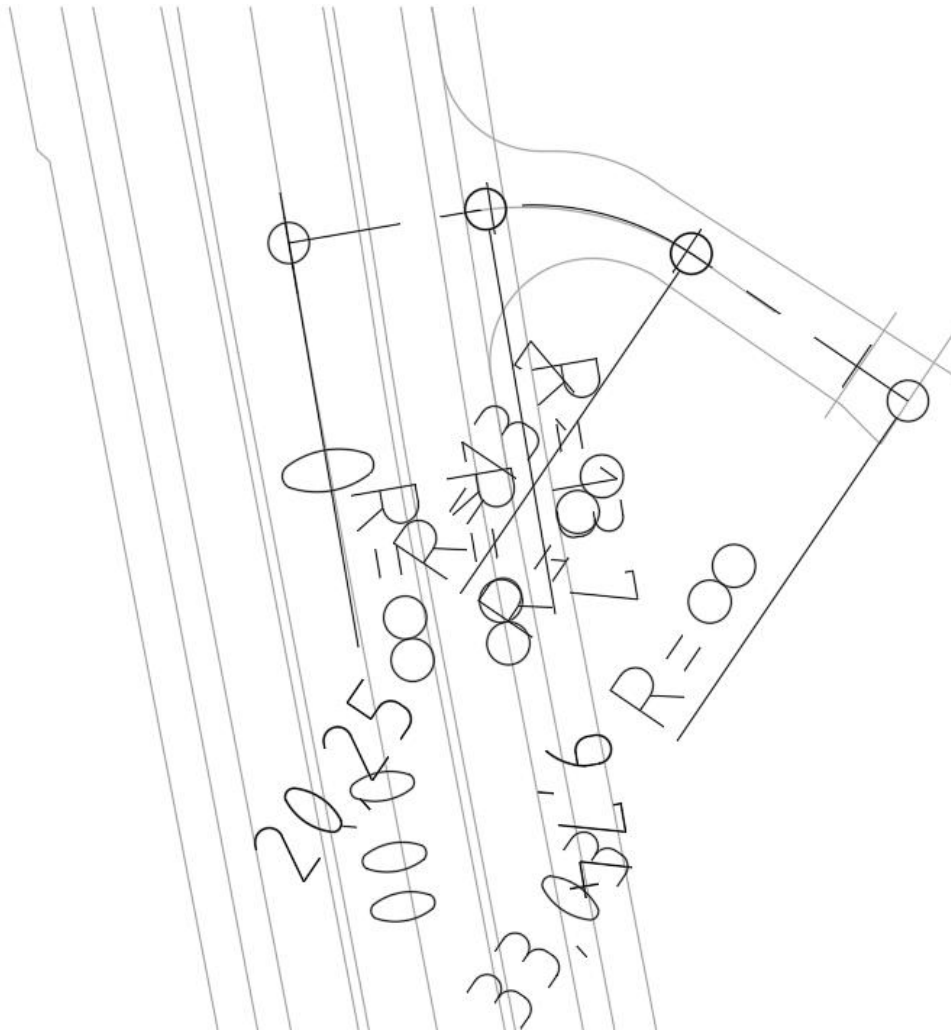

Figur 175 Horizontal alignment, Skjærebergveien

Nr.	Elementype	Innspenning	Radius	Lengde	Param.	Retning	Buetype	Øst1	Nord1	Øst2	Nord2
1	Rettlinje	×—×		9.741		0.170		113936.585	1106225.224	113945.426	1106226.746
2	Sirkelbue	—○—	13.701215	10.512			Kort				
3	Rettlinje	×—×		12.776		5.686		113956.252	1106224.677	113966.776	1106217.526

Figur 176 Horizontal alignment, input data, Skjærebergveien

12.2. Vertical geometry

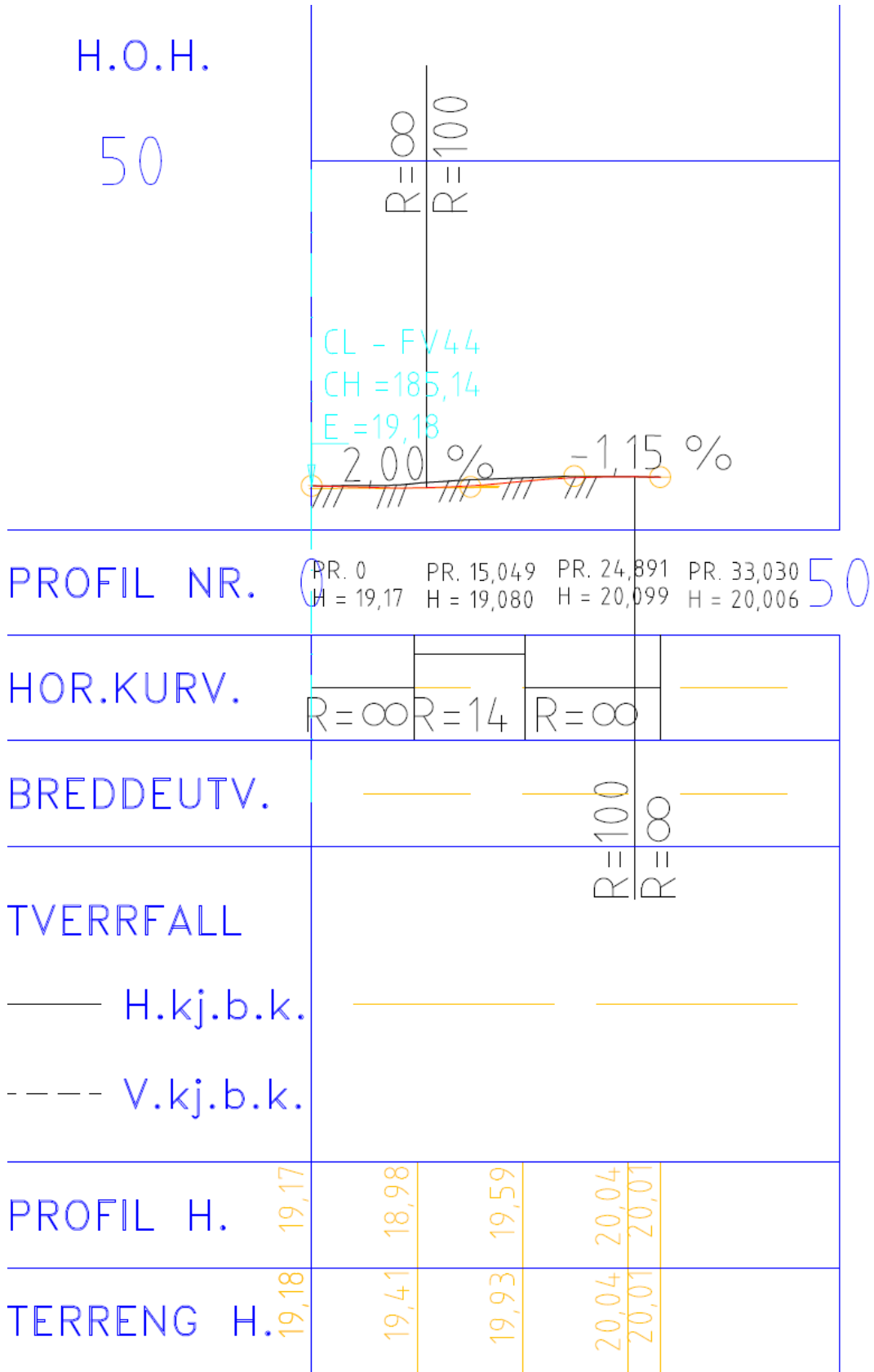

Skjærebergveien

Figur 177 Vertical alignment, Skjærebergveien

12.3. Vegoverflater

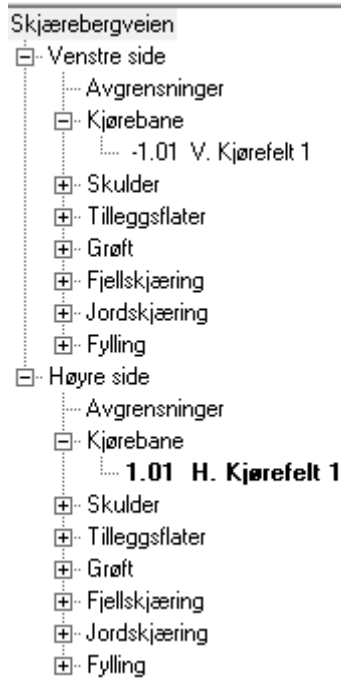

Figur 178 All surfaces of Skjærebergveien

12.3.1. Left side

	Profil	Flate	Linjeavgrensning	Avstand	Object
1	-99999.000	Primærlinje		0.000	
2	10.516	Primærlinje		0.000	
3	Brudd				
4	10.516	-1.01 V. Kjørefelt 1		0.000	
5	999.000	-1.01 V. Kjørefelt 1		0.000	

Figur 179 Boundary, left Skj.

	Profil	Bredde	Helling	Metode	Linje	Fri flate
1	-99999.000	2.000	-0.030			
2	8.778			↕	avgr. Skjærebergveien u	-1.01 V. Kjørefelt 1
3	99.000			↕	avgr. Skjærebergveien u	-1.01 V. Kjørefelt 1
4	99999.000	2.000	-0.030			

Figur 180 Kjørefelt 1, left, Skj.

12.3.2. Right side

	Profil	Flate	Linjeavgrensning	Avstand	Object
1	-99999.000	Primærlinje		0.000	
2	10.681	Primærlinje		0.000	
3	Brudd				
4	10.681	1.01 H. Kjørefelt 1		0.000	
5	99.000	1.01 H. Kjørefelt 1		0.000	

Figur 181 Boundary, right, Skj.

Reason why boundary is at profile 10.681 is because it is the place where CL – Skjærebergveien crosses with outer boundary of sidewalk. Normally if secondary road would be connected perpendicular to primary road and there was no curvature in connection distance, cutting profile would be where roadway is crossing outer sidewalk, but in that case it would give hole in the middle,

so that point was chosen to get overlapping surfaces instead of hole. Same for left side of Skjærebergveien.

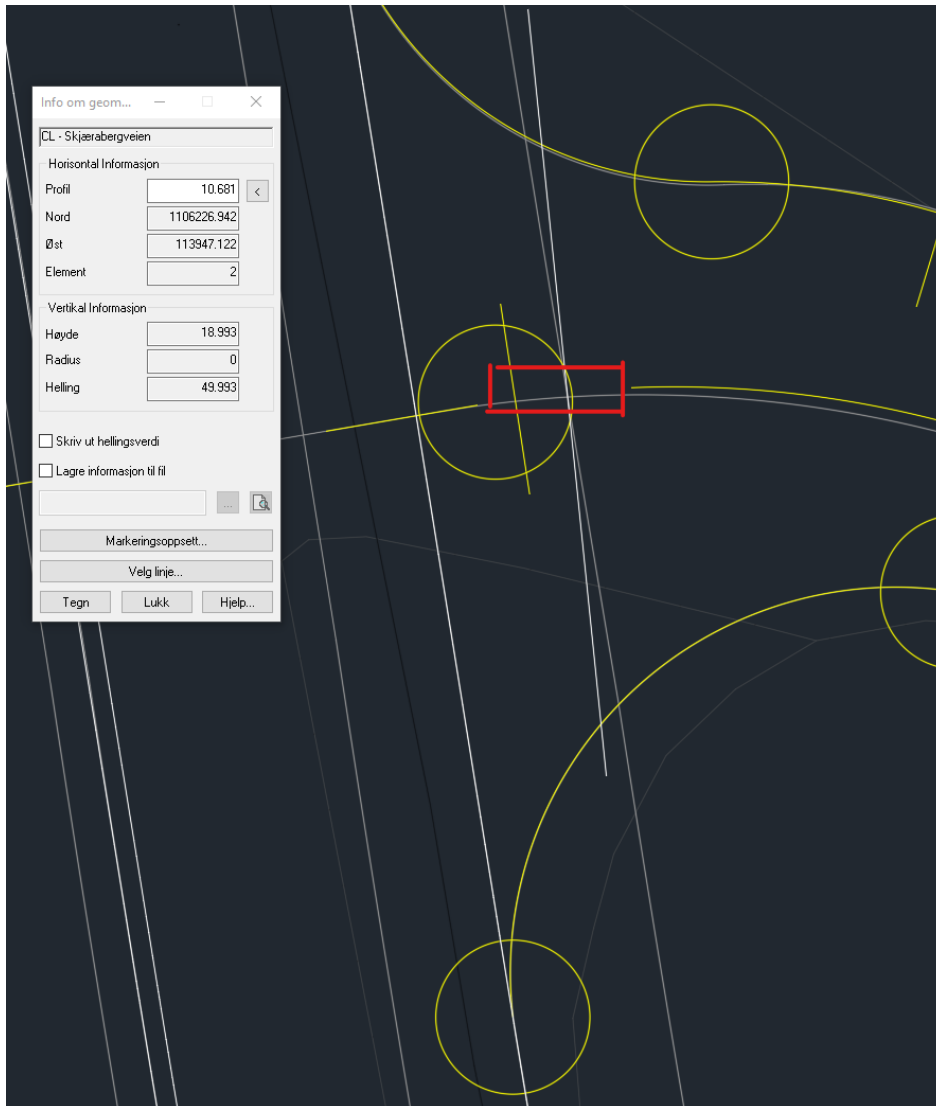

Figur 182 Cutting point for right, Skj.

	Profil	Bredde	Helling	Metode	Linje	Fri flate
1	-99999.000	2.000	-0.030			
2	8.612			↔	avgr. Skjærebergveien i	1.01 H. Kjørefelt 1
3	99.000			↔	avgr. Skjærebergveien i	1.01 H. Kjørefelt 1
4	99999.000	2.000	-0.030			

Figur 183 Kjørefelt 1, right, Skj.

Value for profile 8.612 is found as profile where avgr. Skjærebergveien in crosses with avgr. Sykkelhøyre for FV44. Same situation for left side.

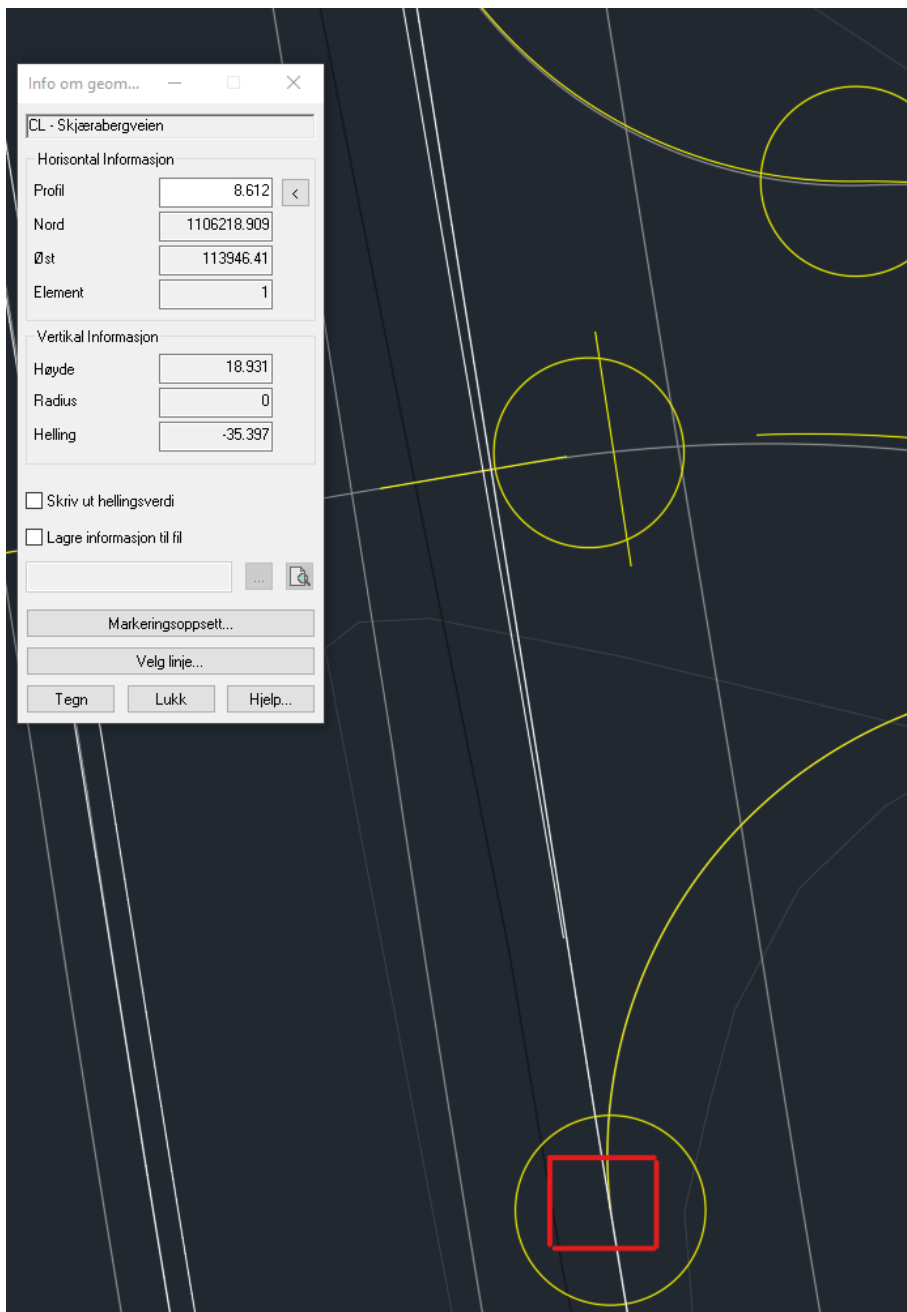

Figur 184 Crossing of avgr. Skjærebergveien in and avgr. Sykkelløype

13. Skjærebergveien in

Skjærebergveien in is only line task and not a road one, thus there is no 3D model, nor surfaces.

13.1. Horizontal geometry

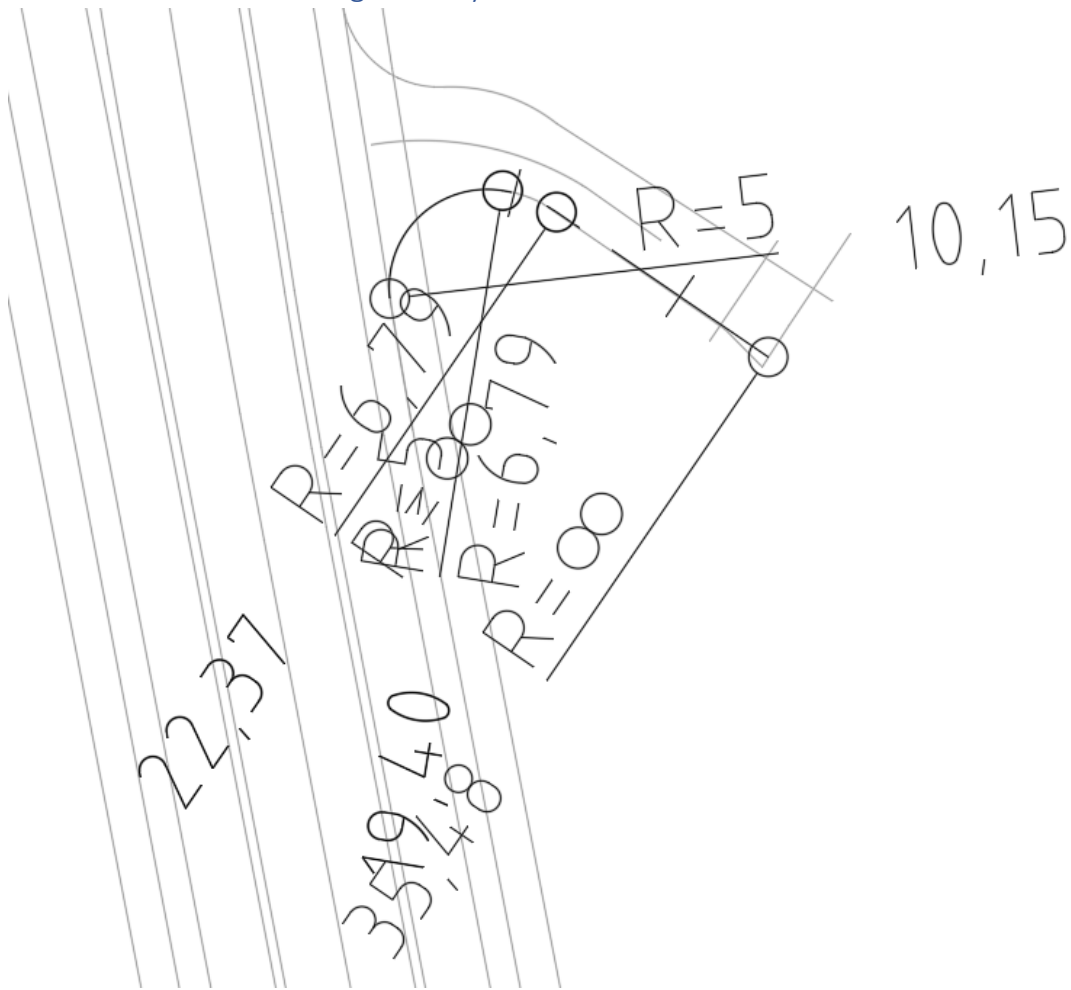

Figur 185 Horizontal alignment, Skjærebergveien in

Nr.	Elementtype	Innspenning	Radius	Lengde	Param.	Retning	Buetype	Øst1	Nord1	Øst2	Nord2
1	Sirkelbue	—x	5.000875	9.247			Kort	113946.412	1106218.892		
2	Sirkelbue	x—x	6.788655	2.978			Kort	113952.202	1106224.406	113954.968	1106223.281
3	Rettlinje	—x		13.103		0.000		113965.737	1106215.907		

Figur 186 Horizontal alignment, input data, Skjærebergveien

13.2. Vertical geometry

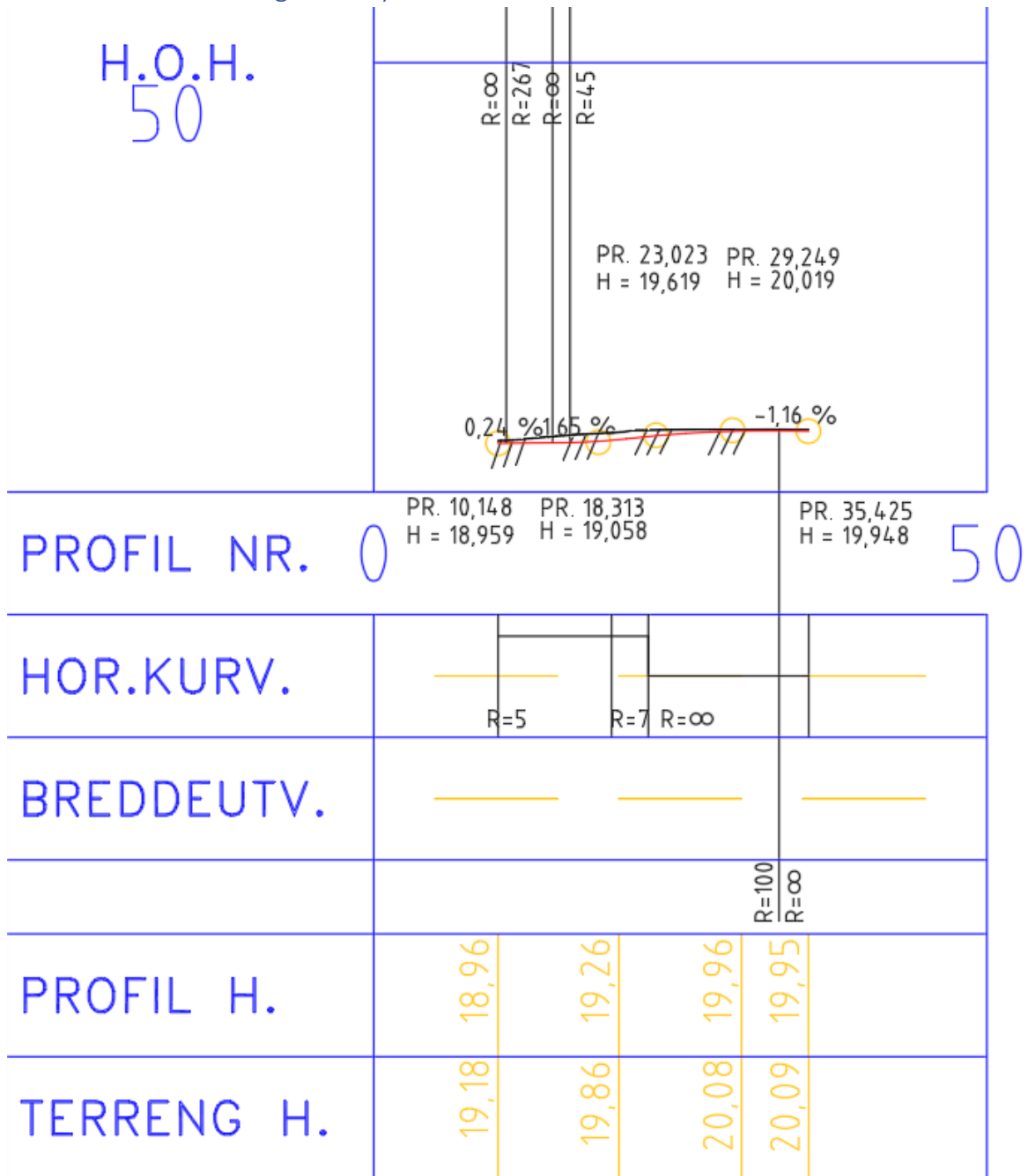

Skjærebergveien in

Figur 187 Vertical alignment, Skjærebergveien in

14. Skjærebergveien ut

Skjærebergveien ut is only line task and not a road one, thus there is no 3D model, nor surfaces.

14.1. Horizontal geometry

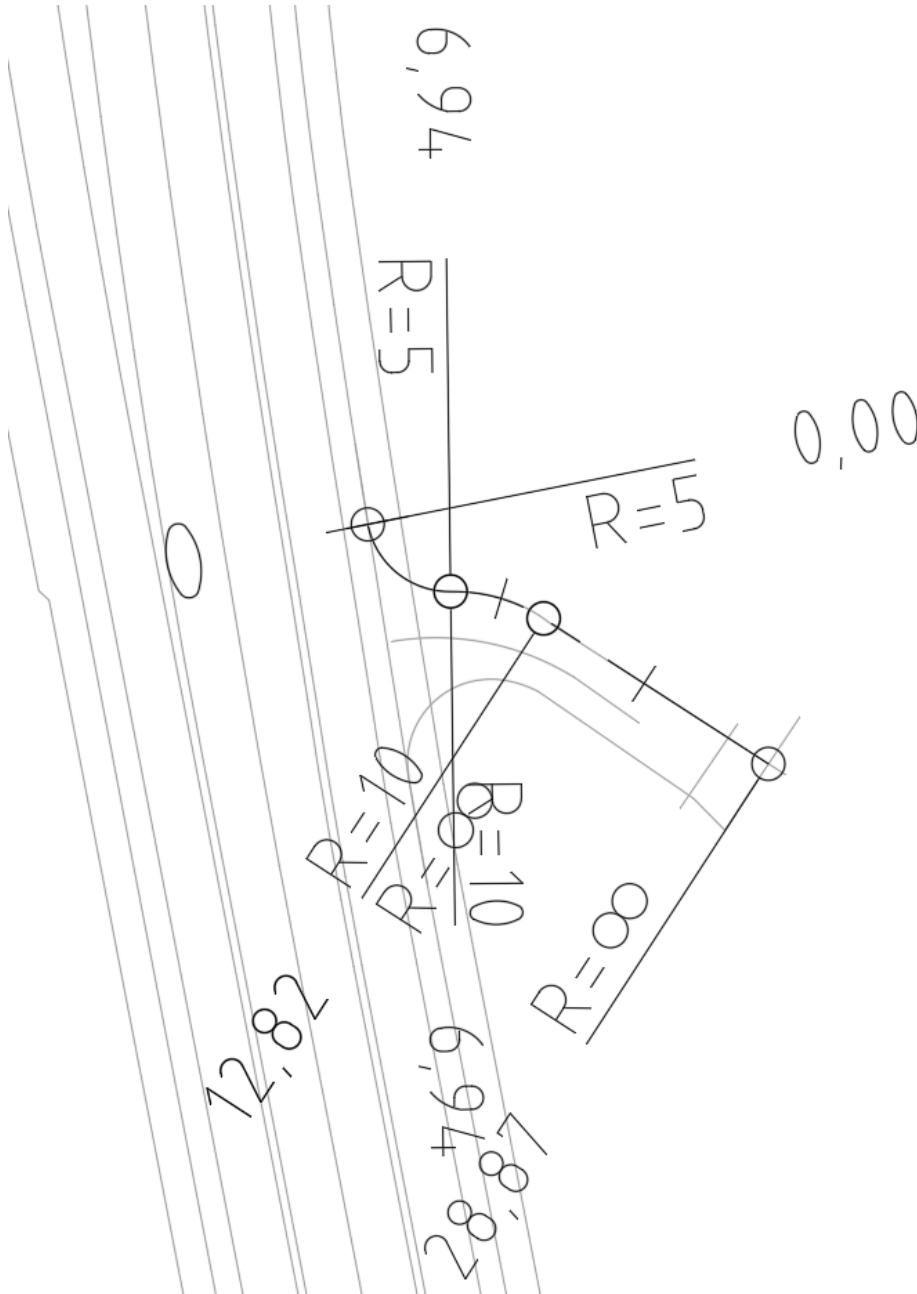

Figur 188 Horizontal alignment, Skjærebergveien ut

Nr.	Elementtype	Innspenning	Radius	Lengde	Param.	Retning	Buetype	Øst1	Nord1	Øst2	Nord2
1	Sirkelbue	→←	-5.000	6.940			Kort	113944.023	1106233.764		
2	Sirkelbue	→←	10.000	5.883			Kort	113950.205	1106229.678		
3	Rettlinje	×→		16.050		5.708		113957.329	1106226.332	113968.027	1106219.393

Figur 189 Vertical alignment, input data, Skjærebergveien ut

14.2. Vertical geometry

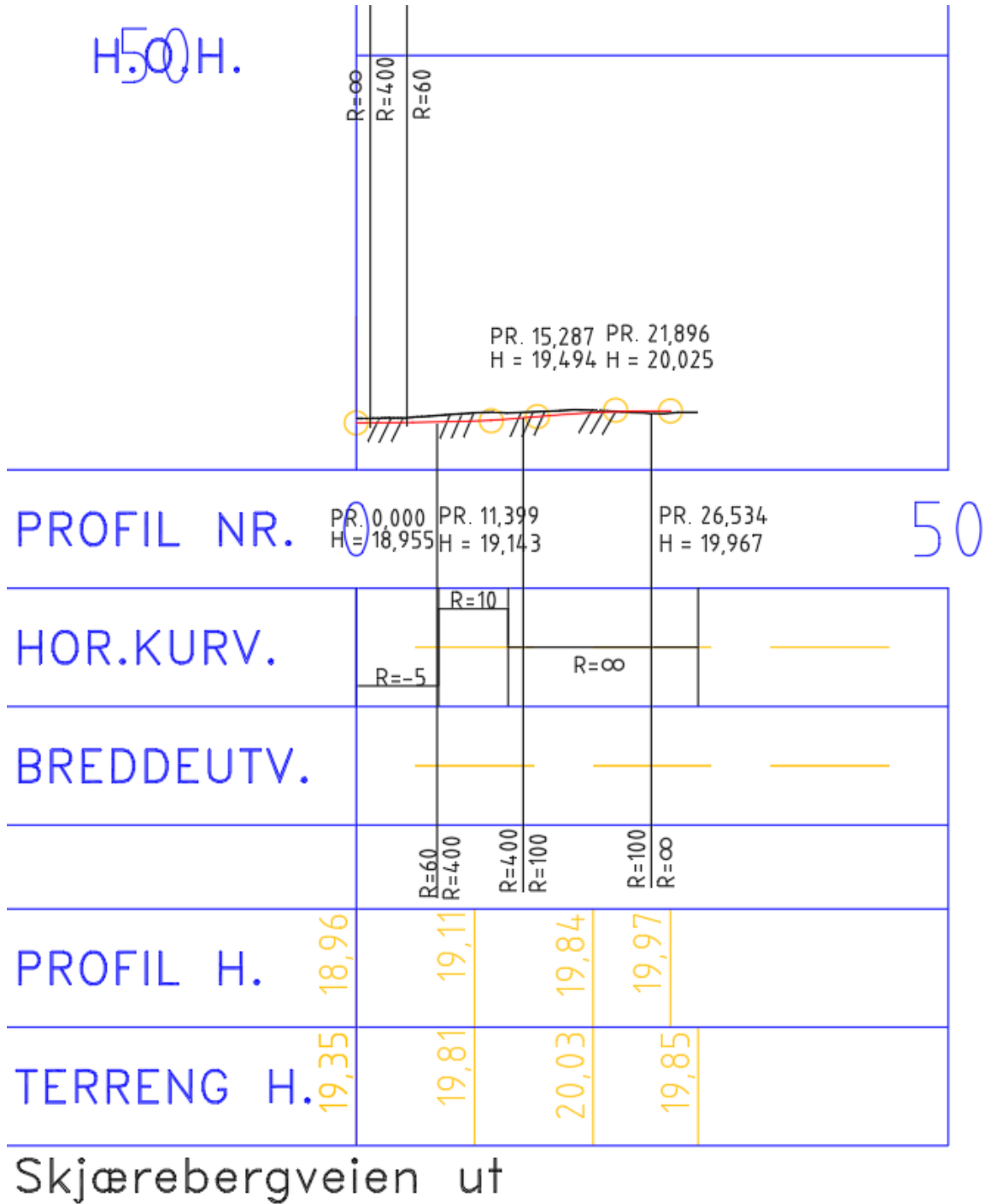

Figur 190 Vertical alignment, Skjærebergveien ut

15. Høylandsgata (Høy.)

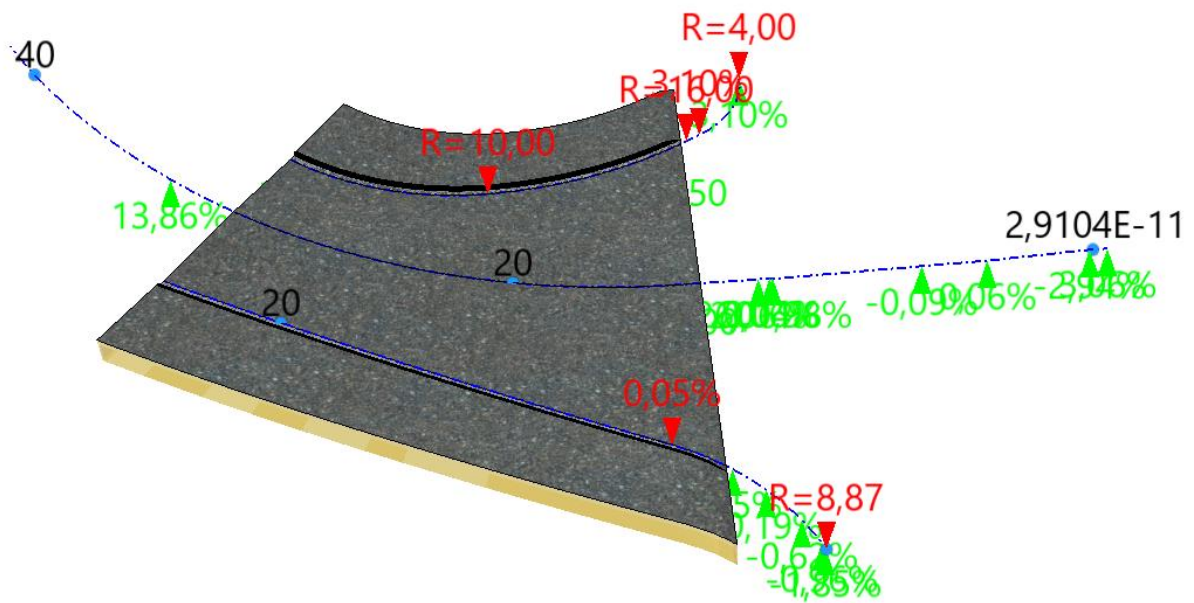

Figur 191 Høylandsgata (view from south)

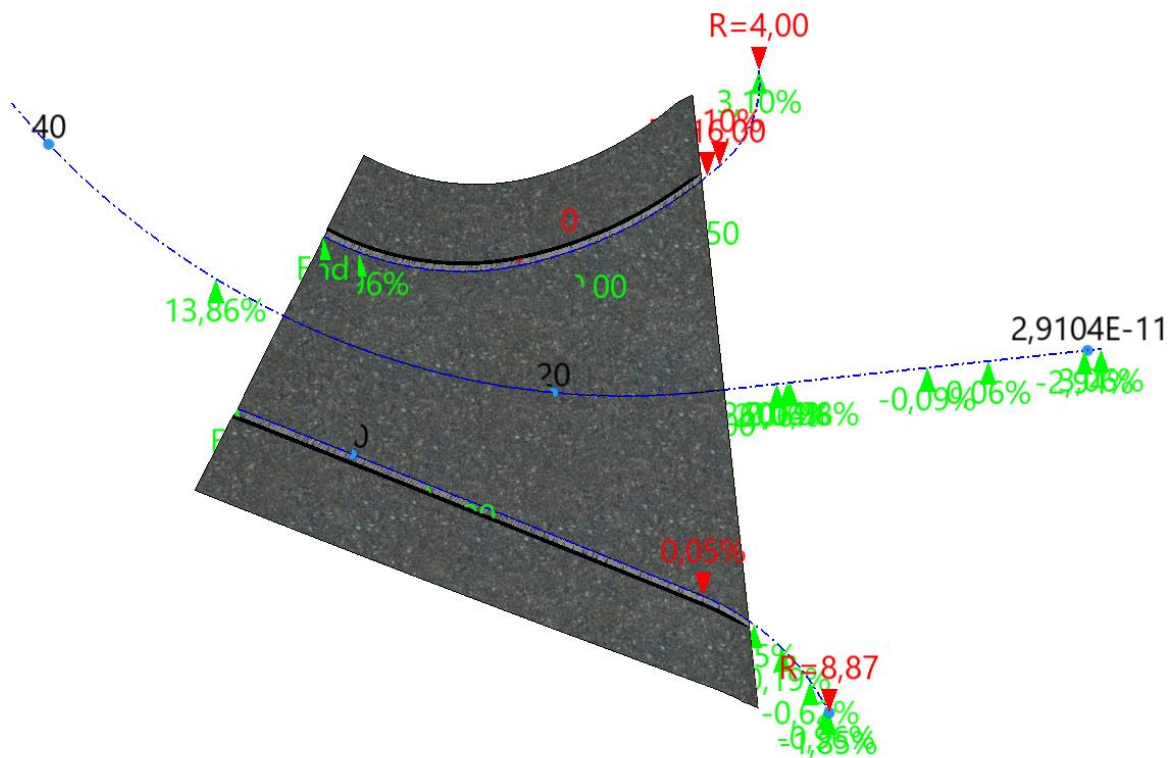

Figur 192 Høylandsgata (view from top)

15.1. Horizontal geometry

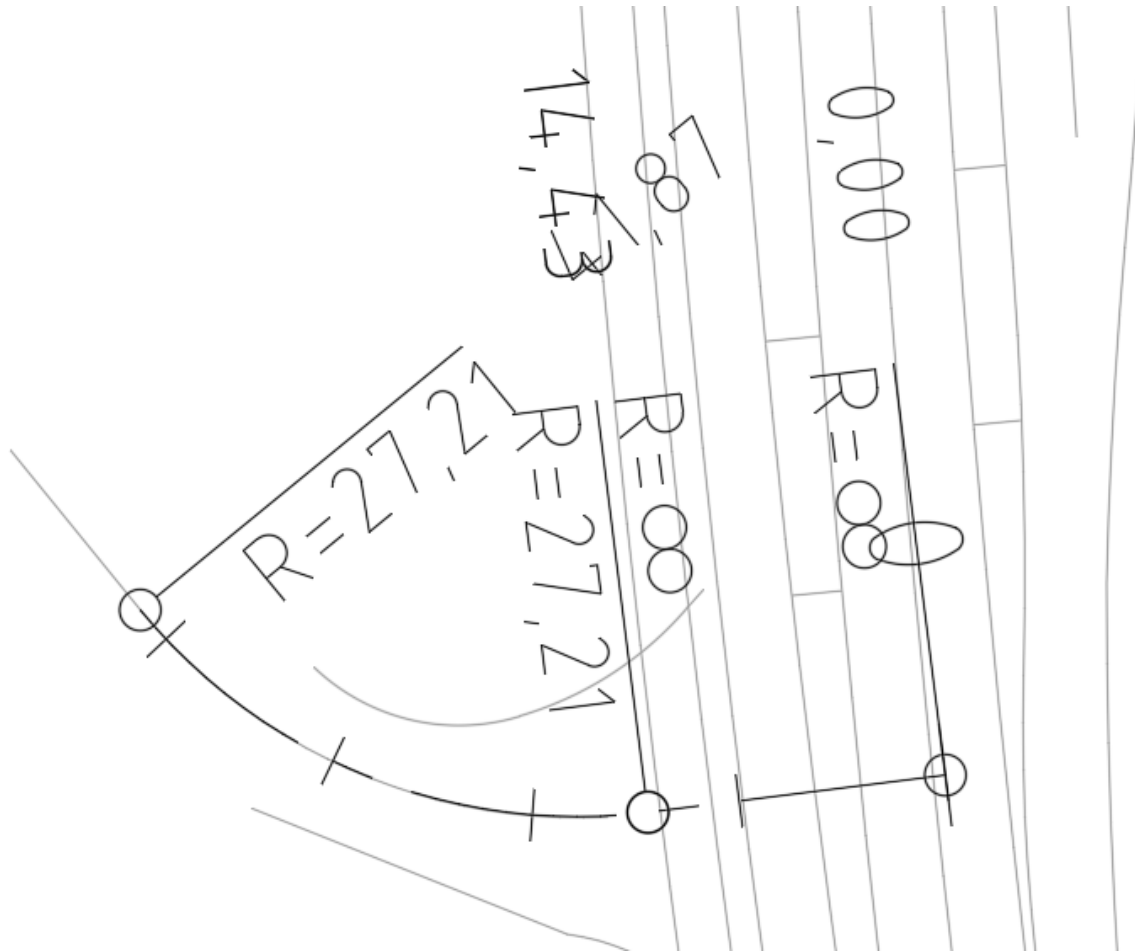

Figur 193 Horizontal alignment, Høylandsgata

Nr.	Elementtype	Innspenning	Radius	Lengde	Param.	Retning	Buetype	Øst1	Nord1	Øst2	Nord2
1	Rettlinje	×—×		14.430		3.266		113928.880	1106286.175	113915.144	1106284.455
2	Sirkelbue	—×	27.20518	27.443			Kort	113890.142	1106294.129		

Figur 194 Horizontal alignment, input data, Høylandsgata

15.2. Vertical geometry

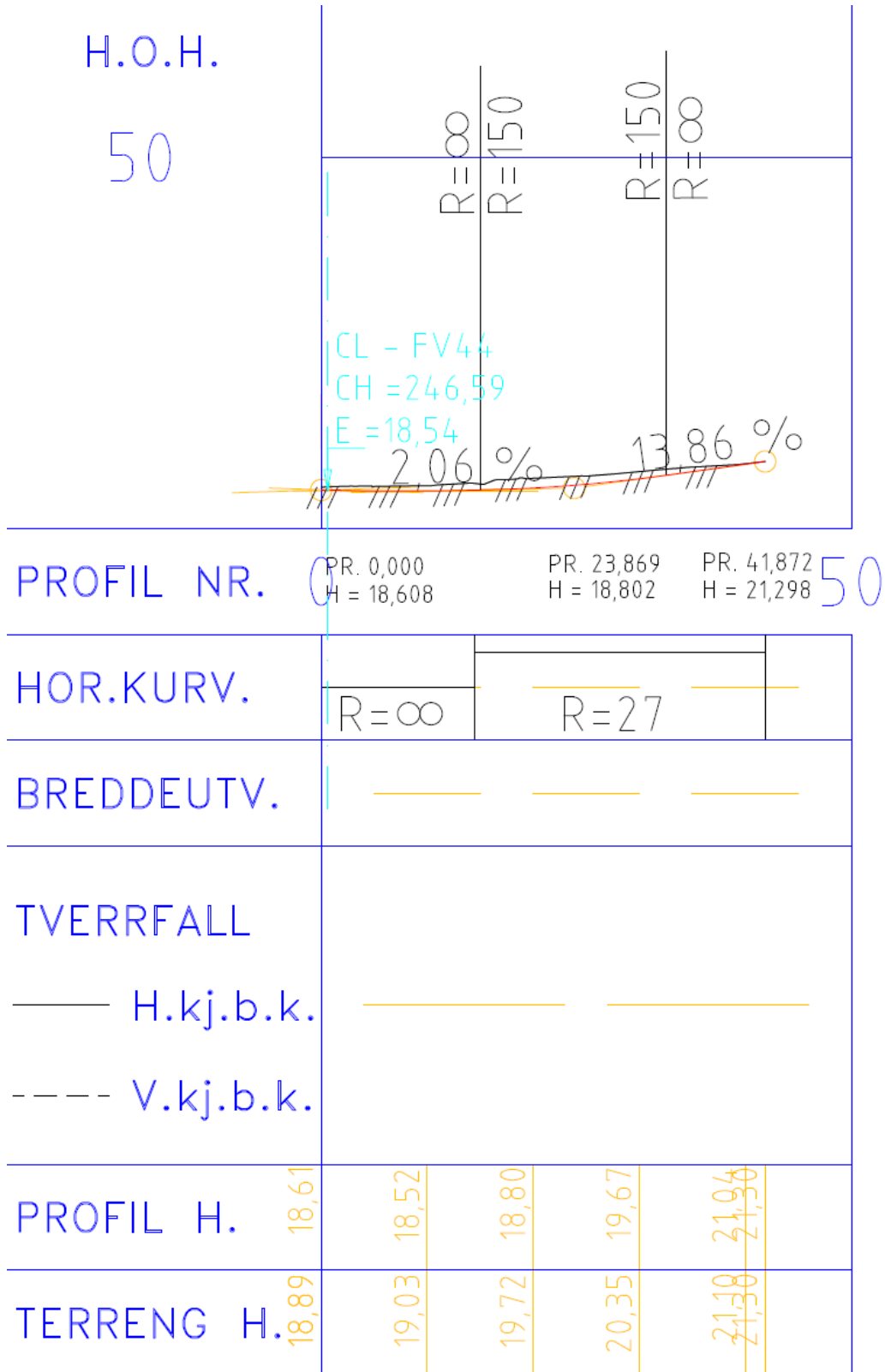

Høylandsgata

Figur 195 Vertical alignment, Høylandsgata

15.3. Vegoverflater

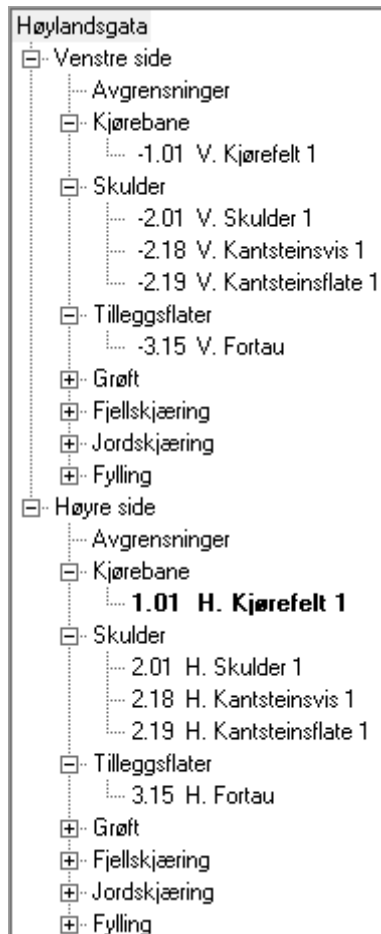

Figur 196 All surfaces for Høylandsgata

15.3.1. Left side

	Profil	Flate	Linjeavgrensning	Avstand	Object
1	-99999.000	Primærlinje		0.000	
2	13.798	Primærlinje		0.000	
3	Brudd				
4	13.798	-3.15 V. Fortau		0.000	
5	99999.000	-3.15 V. Fortau		0.000	

Figur 197 Boundary, left, Høy.

	Profil	Bredde	Helling	Metode	Linje	Fri flate
1	-99999.000	3.000	-0.030			
2	11.258			↕	avgr. Høylandsgata ut	-1.01 V. Kjørefelt 1
3	31.873			↕	avgr. Høylandsgata ut	-1.01 V. Kjørefelt 1
4	99999.000	3.000	-0.030			

Figur 198 Kjørefelt 1, left, Høy.

	Profil	Bredde	Helling	Metode	Linje	Fri flate
1	-99999.000	0.250	Arv			
2	99999.000	0.250	Arv			

Figur 199 Skulder 1, left, Høy.

	Profil	Bredde	Helling	Metode	Linje	Fri flate
1	-99999.000	0.000	13.000			
2	13.798	0.000	13.000			
3	14.298	0.010	13.000			
4	99999.000	0.010	13.000			

Figur 200 Kantsteinsvis 1, left, Høy.

	Profil	Bredde	Helling	Metode	Linje	Fri flate
1	-99999.000	0.000	0.000			
2	13.798	0.000	0.000			
3	14.298	0.090	0.000			
4	99999.000	0.090	0.000			

Figur 201 Kantsteinsflate 1, left, Høy.

	Profil	Bredde	Helling	Metode	Linje	Fri flate
1	-99999.000	2.900	0.020			
2	99999.000	2.900	0.020			

Figur 202 Fortau, left, Høy.

15.3.2. Right side

	Profil	Flate	Linjeavgrensning	Avstand	Object
1	-99999.000	Primærlinje		0.000	
2	13.801	Primærlinje		0.000	
3	Brudd				
4	13.801	3.15 H. Fortau		0.000	
5	999.000	3.15 H. Fortau		0.000	

Figur 203 Boundary, right, Høy.

	Profil	Bredde	Helling	Metode	Linje	Fri flate
1	-99999.000	3.000	-0.030			
2	11.410			↕	avgr. Høylandsgata in	1.01 H. Kjørefelt 1
3	32.391			↕	avgr. Høylandsgata in	1.01 H. Kjørefelt 1
4	99999.000	3.000	-0.030			

Figur 204 Kjørefelt 1, right, Høy.

	Profil	Bredde	Helling	Metode	Linje	Fri flate
1	-99999.000	0.250	Arv			
2	99999.000	0.250	Arv			

Figur 205 Skulder 1, right, Høy.

	Profil	Bredde	Helling	Metode	Linje	Fri flate
1	-99999.000	0.000	13.000			
2	13.804	0.000	13.000			
3	14.304	0.010	13.000			
4	99999.000	0.010	13.000			

Figur 206 Kantsteinsvis 1, right, Høy.

	Profil	Bredde	Helling	Metode	Linje	Fri flate
1	-99999.000	0.000	0.000			
2	13.804	0.000	0.000			
3	14.304	0.090	0.000			
4	99999.000	0.090	0.000			

Figur 207 Kantsteinsflate 1, right, Høy.

	Profil	Bredde	Helling	Metode	Linje	Fri flate
1	-99999.000	2.900	0.020			
2	99999.000	2.900	0.020			

Figur 208 Fortau, right, Høy.

16. Rundkjøringen north, right (Rnr.)

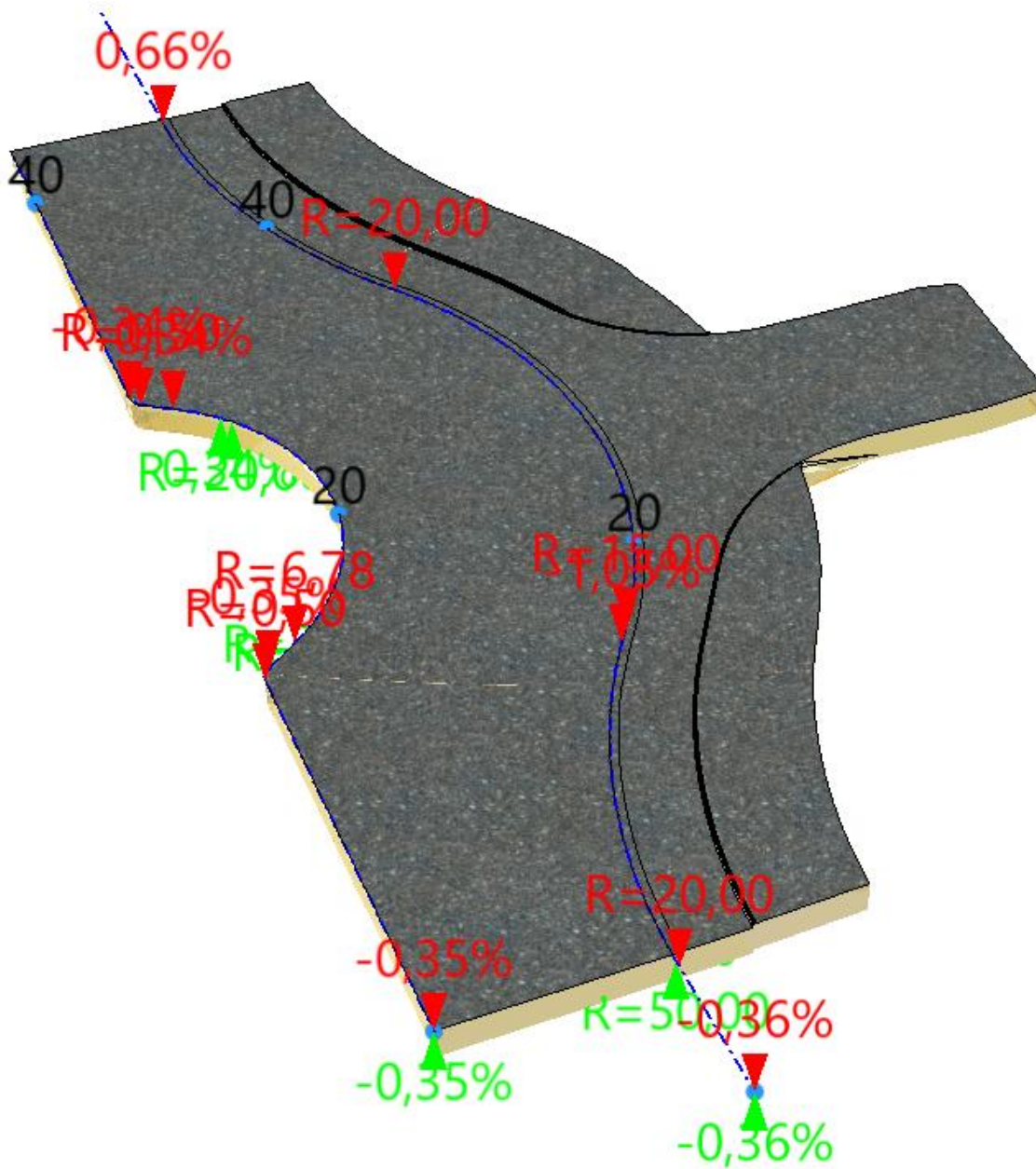

Figur 209 Rundkjøringen north, right (view from south)

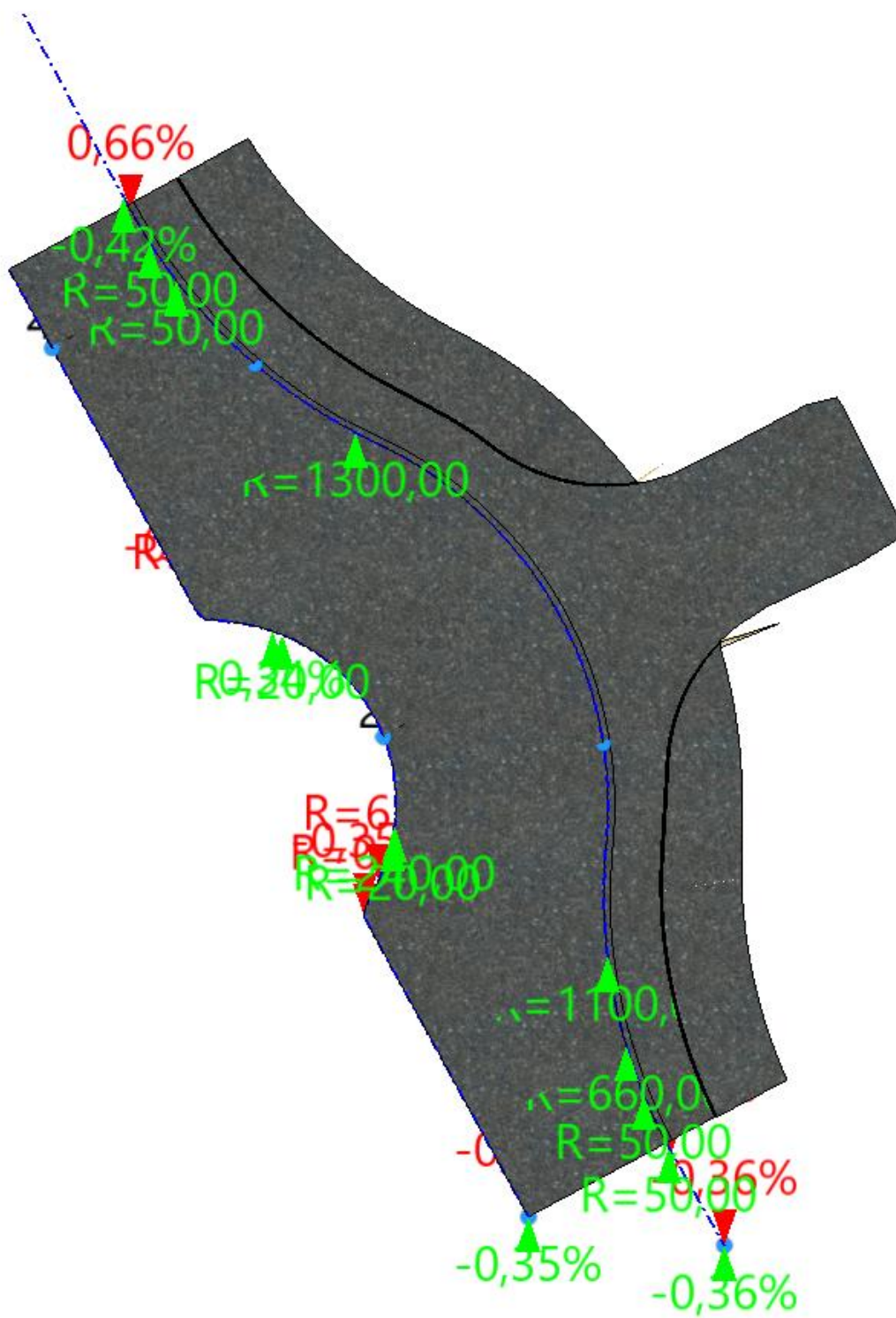

Figur 210 Rundkjøringen north, right (view from top)

16.1. Horizontal geometry

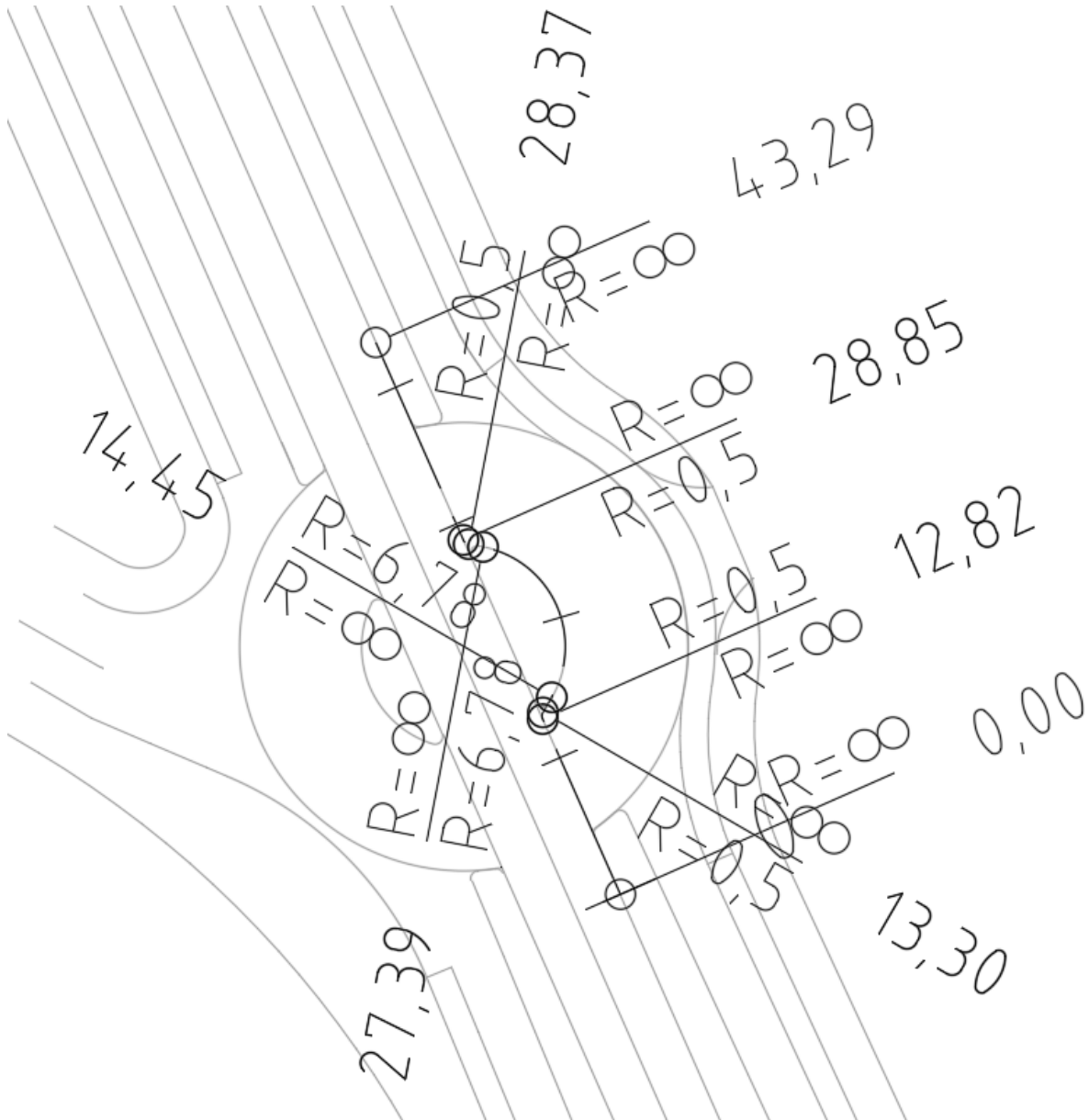

Figur 211 Horizontal alignment, rund. Nord h. kjørefelt

Nr.	Elementtype	Innspenning	Radius	Lengde	Param.	Retning	Buetype	Øst1	Nord1	Øst2	Nord2
1	Rettlinje	×—×		12.825		1.988		113871.734	1106552.040	113866.517	1106563.813
2	Sirkelbue	—×	0.500	0.471			Kort	113866.849	1106564.446		
3	Rettlinje	—×		1.157		0.000		113867.178	1106565.280		
4	Sirkelbue	—×	-6.780	12.934			Kort	113862.641	1106575.262		
5	Rettlinje	—×		0.979		0.000		113862.472	1106575.295		
6	Sirkelbue	—×	0.500	0.483			Kort	113861.241	1106575.719		
7	Rettlinje	—×		14.446		0.000		113855.374	1106588.960		

Figur 212 Horizontal alignment, input data, rund. nord h. kjørefelt

16.2. Vertical geometry

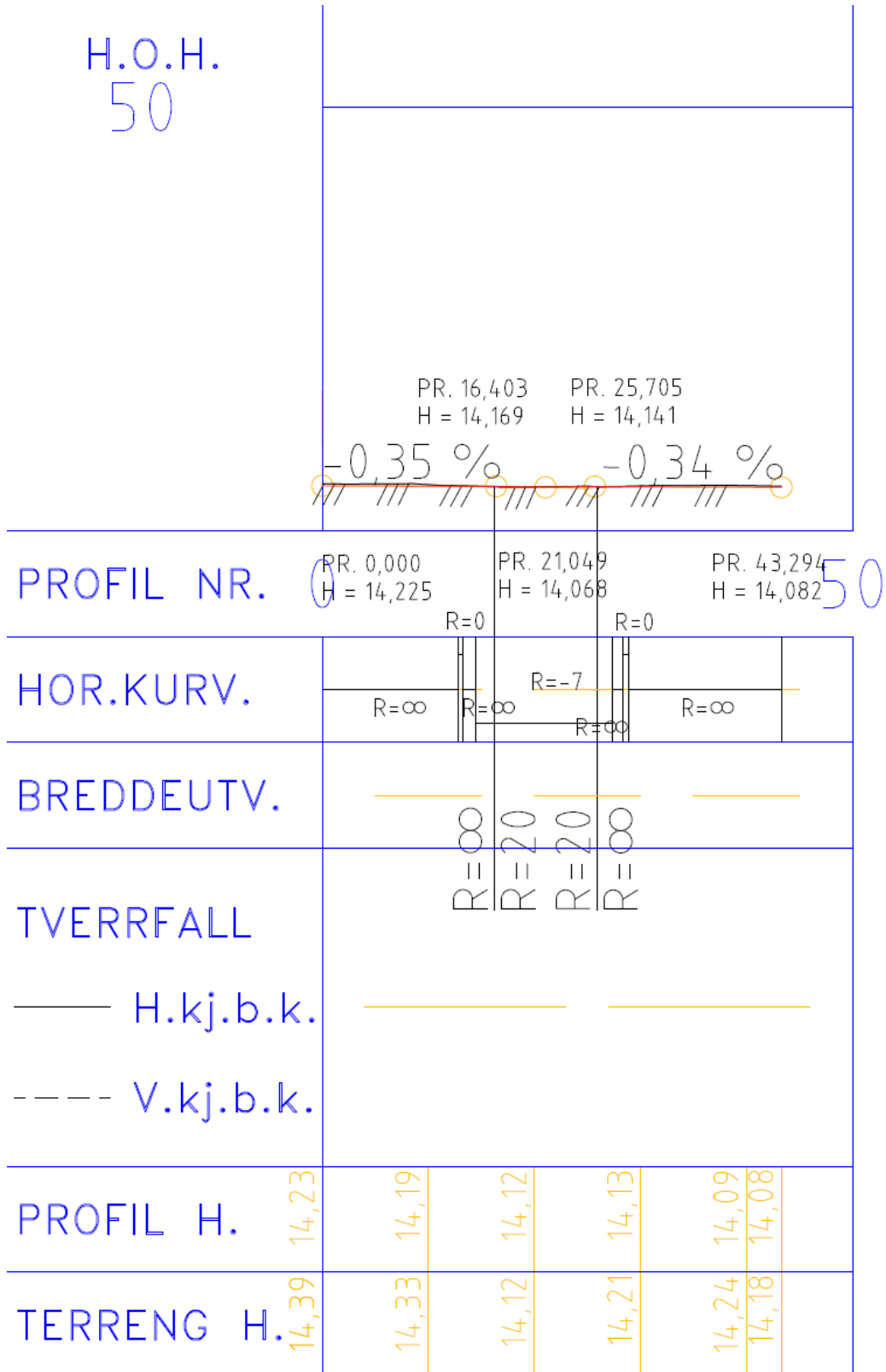

Rundkjøring nord høyre kjørefelt

Figur 213 Vertical alignment, rund. nord h. kjørefelt

16.3. Vegoverflater

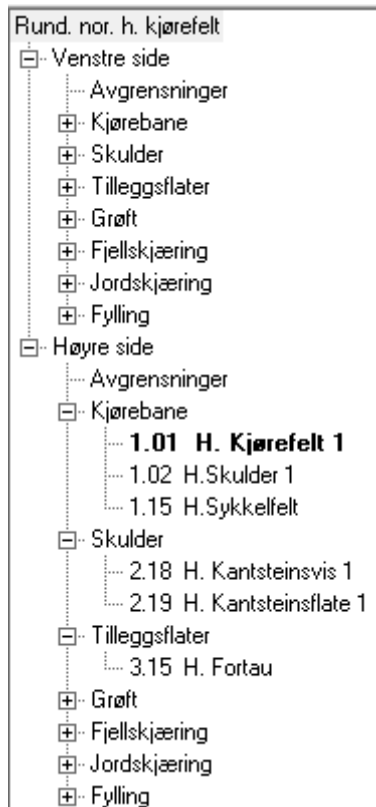

Figur 214 All surfaces for Rnr.

16.3.1. Left side

	Profil	Flate	Linjeavgrensning	Avstand	Object
1	-99.000	Primærlinje		0.000	
2	99.000	Primærlinje		0.000	

Figur 215 Boundary, left, Rnr.

16.3.2. Right side

	Profil	Flate	Linjeavgrensning	Avstand	Object
1	-99.000	3.15 H. Fortau		0.000	
2	19.569	3.15 H. Fortau		0.000	
3	Brudd				
4	19.569	1.15 H.Sykkelfelt		0.000	
5	21.867	1.15 H.Sykkelfelt		0.000	
6	Brudd				
7	21.867	3.15 H. Fortau		0.000	
8	99.000	3.15 H. Fortau		0.000	

Figur 216 Boundary, right, Rnr.

	Profil	Bredde	Helling	Metode	Linje	Fri flate
1	-99999.000	7.930	-0.030			
2	-99.000			↕	rund. nor. h. innkjøring	1.01 H. Kjørefelt 1
3	99.000			↕	rund. nor. h. innkjøring	1.01 H. Kjørefelt 1
4	99999.000	7.930	-0.030			

Figur 217 Kjørefelt 1, right, Rnr.

	Profil	Bredde	Helling	Metode	Linje	Fri flate
1	-999.000	0.250	Arv			
2	999.000	0.250	Arv			

Figur 218 Skulder 1, right, Rnr.

	Profil	Bredde	Helling	Metode	Linje	Fri flate
1	-9999.000	2.000	0.000			
2	-99.000			↘	rund. nor. h. ytre	1.15 H.Sykkelfelt
3	99.000			↘	rund. nor. h. ytre	1.15 H.Sykkelfelt
4	9999.000	2.000	0.000			

Figur 219 Sykkelfelt, right, Rnr.

	Profil	Bredde	Helling	Metode	Linje	Fri flate
1	-99999.000	0.010	13.000			
2	18.093	0.010	13.000			
3	18.293	0.010	2.000			
4	23.100	0.010	2.000			
5	23.300	0.010	13.000			
6	99999.000	0.010	13.000			

Figur 220 Kantsteinsvis 1, right, Rnr.

	Profil	Bredde	Helling	Metode	Linje	Fri flate
1	-99999.000	0.090	0.000			
2	99999.000	0.090	0.000			

Figur 221 Kantsteinsflate 1, right, Rnr.

	Profil	Bredde	Helling	Metode	Linje	Fri flate
1	-99999.000	2.900	0.020			
2	-99.000			↘	avgr. fortau høyre	3.15 H. Fortau
3	99.000			↘	avgr. fortau høyre	3.15 H. Fortau
4	99999.000	2.900	0.020			

Figur 222 Fortau, right, Rnr.

17. Rundkjøringen north, left (Rnl.)

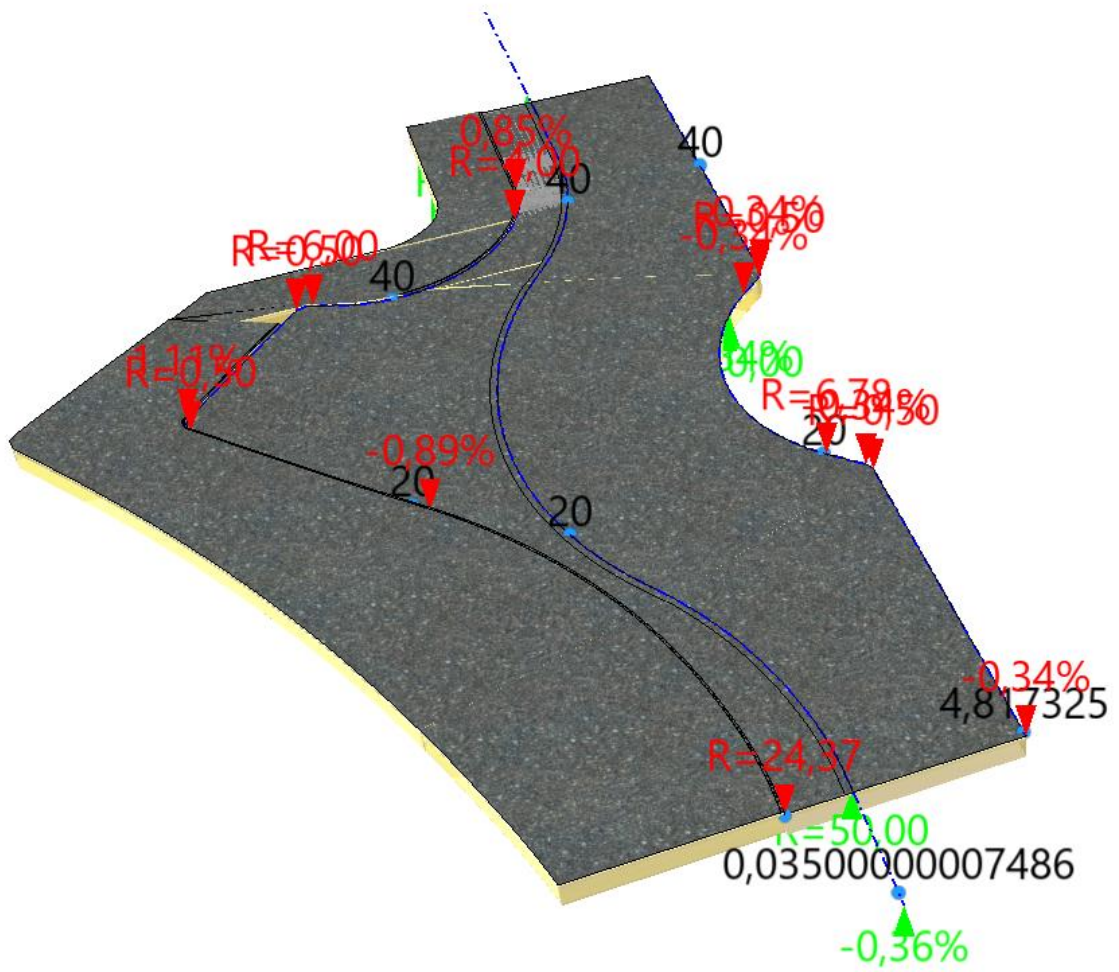

Figur 223 Rundkjøringen nord v. kjørefelt (view from south)

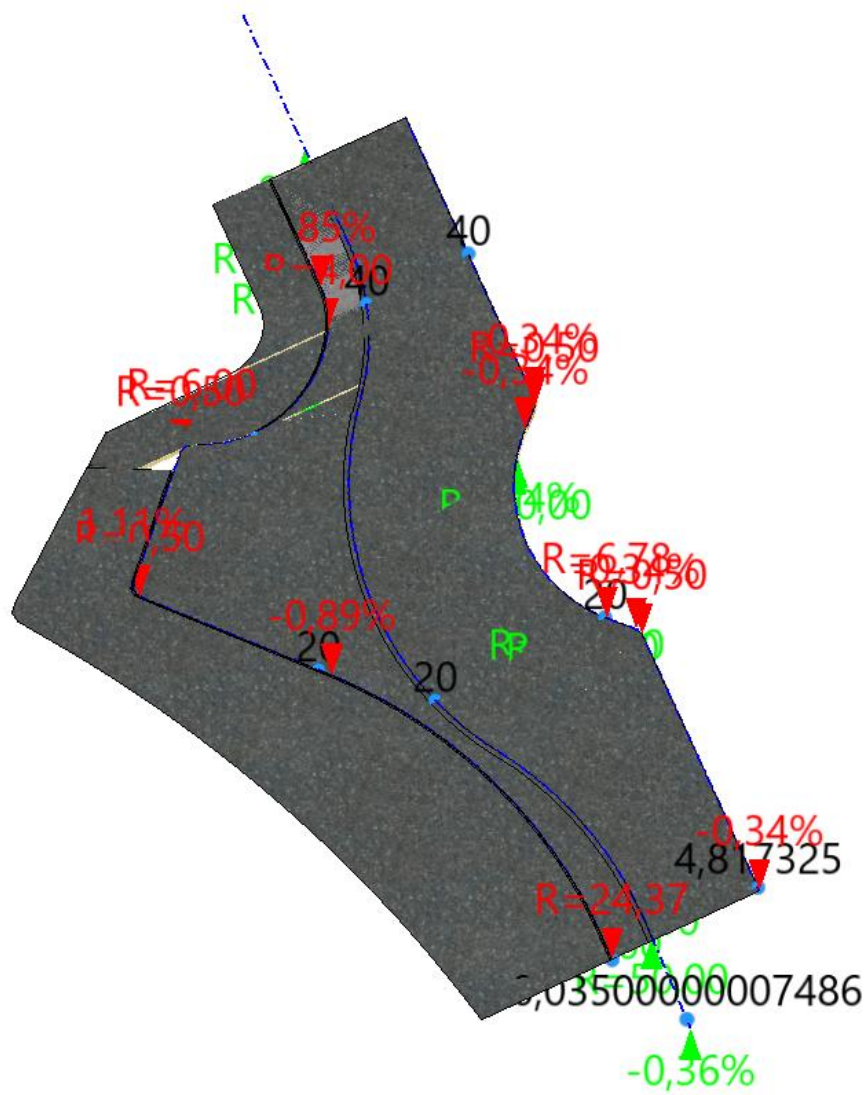

Figur 224 Rundkjøringen nord v. kjørefelt (view from top)

17.1. Horizontal geometry

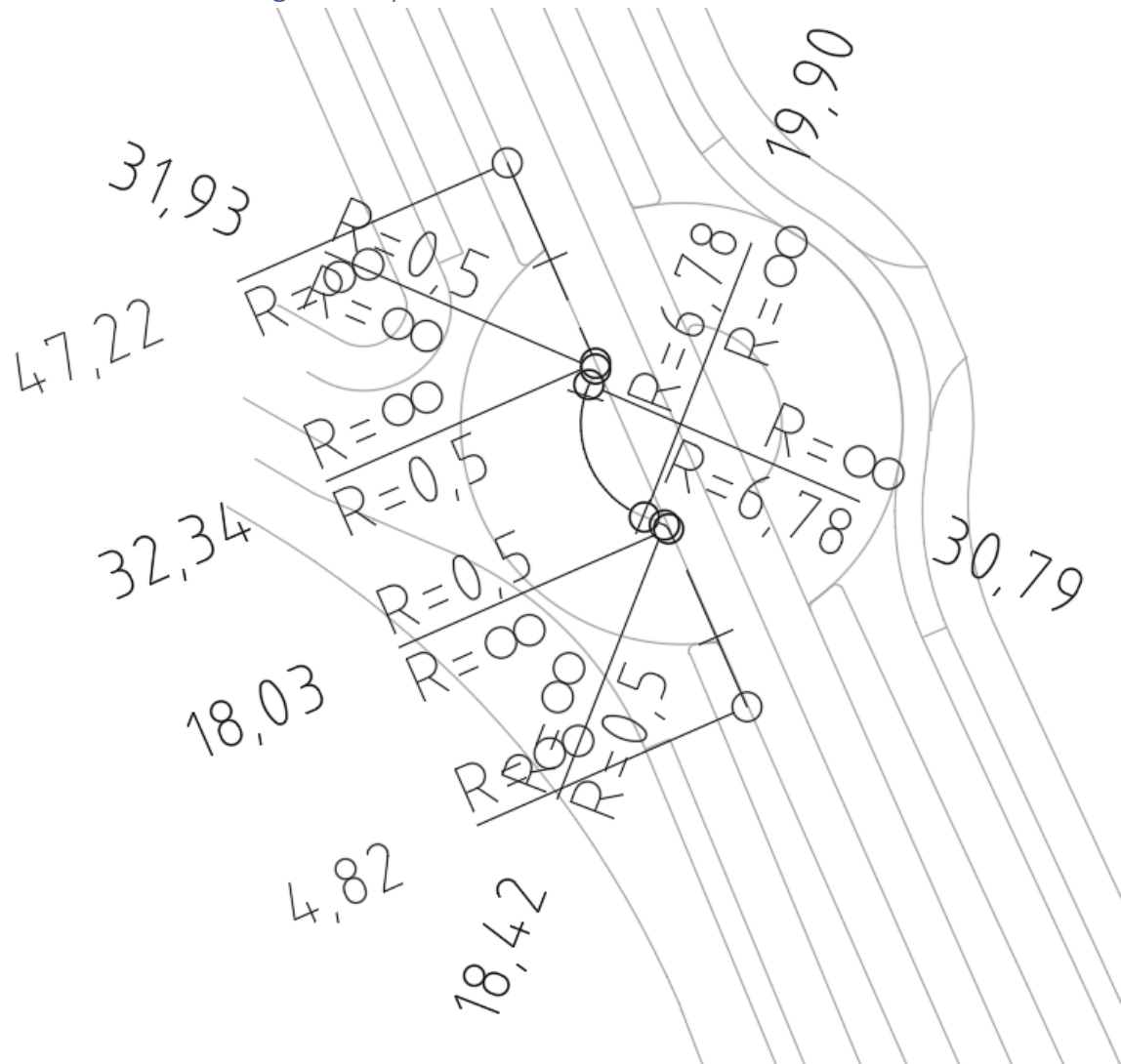

Figur 225 Horizontal alignment, rund. nord v. kjørefelt

Nr.	Elementtype	Innspenning	Radius	Lengde	Param.	Retning	Buetype	Øst1	Nord1	Øst2	Nord2
1	Rettlinje	×—×		13.211		1.985		113865.685	1106549.367	113860.305	1106561.598
2	Sirkelbue	—×	-0.500	0.392			Kort	113860.020	1106561.746		
3	Rettlinje	—×		1.476		0.000		113858.524	1106562.336		
4	Sirkelbue	—×	6.780	10.893			Kort	113854.880	1106571.074		
5	Rettlinje	—×		1.143		0.000		113855.019	1106571.402		
6	Sirkelbue	—×	-0.500	0.411			Kort	113855.422	1106572.701		
7	Rettlinje	—×		14.872		0.000		113849.426	1106586.331		

Figur 226 Horizontal alignment, input data, rund. nord v. kjørefelt

17.2. Vertical geometry

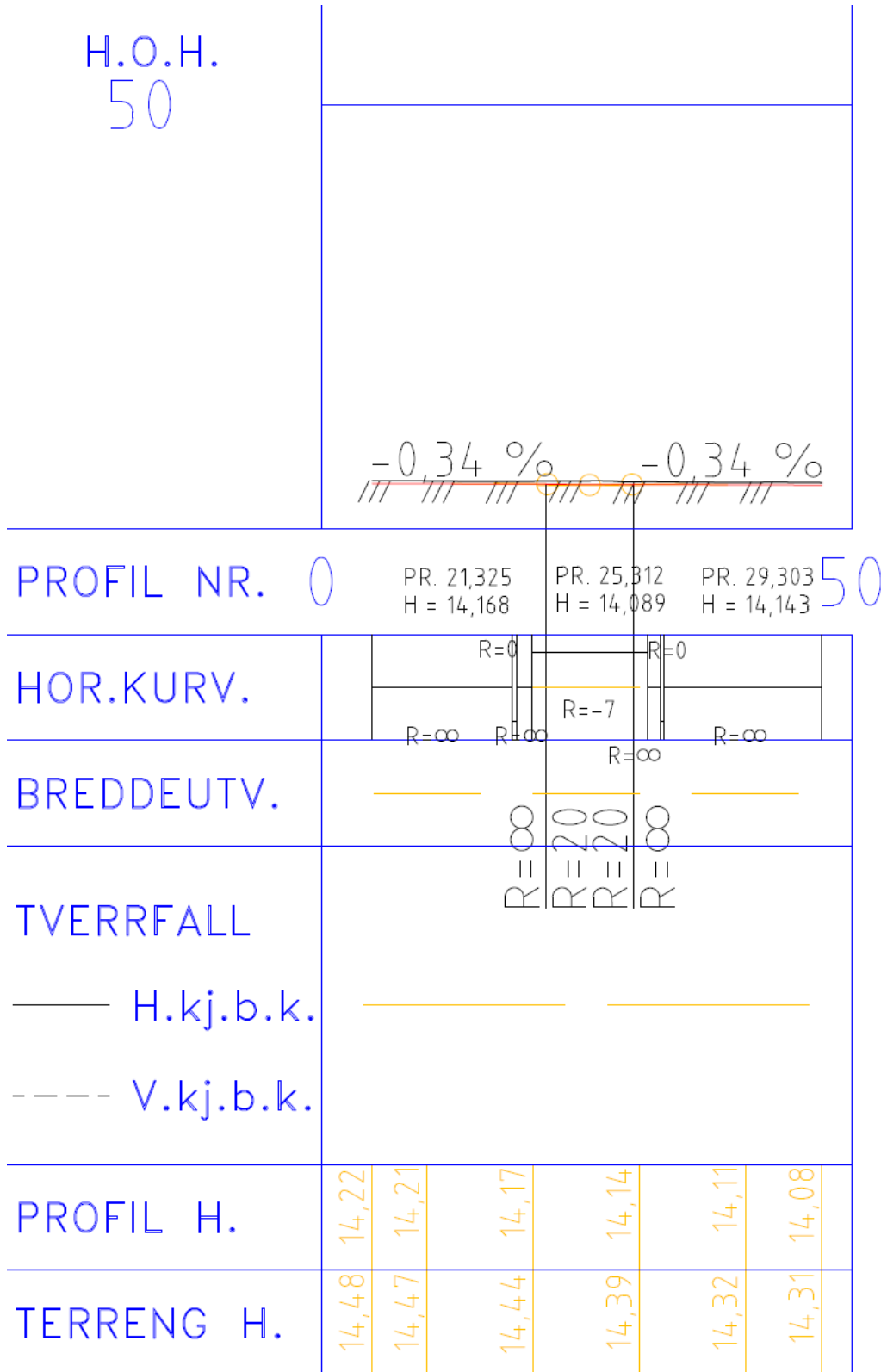

Rundkjøring nord venstre kjørefelt

Figur 227 Vertical alignment, rund. nord v. kjørefelt

17.3. Vegoverflater

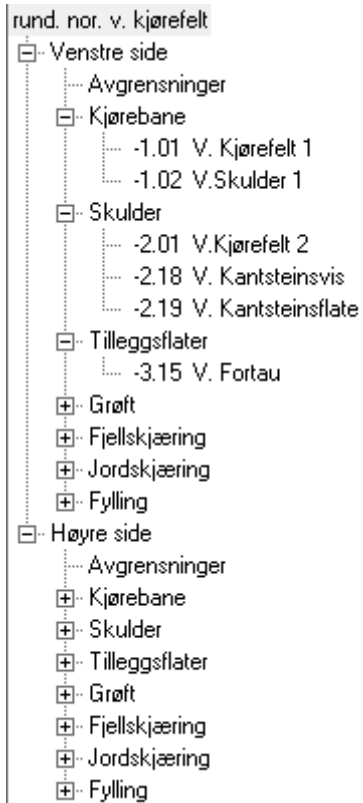

Figur 228 All surfaces for Rnl.

17.3.1. Left side

	Profil	Flate	Linjeavgrensning	Avstand	Object
1	-99.000	-3.15 V. Fortau		0.000	
2	28.334	-3.15 V. Fortau		0.000	
3		Brudd			
4	28.334	-2.01 V. Kjørefelt 2		0.000	
5	32.881	-2.01 V. Kjørefelt 2		0.000	
6		Brudd			
7	32.881	-3.15 V. Fortau		0.000	
8	99.000	-3.15 V. Fortau		0.000	

Figur 229 Boundary, left, Rnl.

	Profil	Bredde	Helling	Metode	Linje	Fri flate
1	-99999.000	3.000	-0.030			
2	-99.000			↕	rund. nor. v. innkjøring	-1.01 V. Kjørefelt 1
3	99.000			↕	rund. nor. v. innkjøring	-1.01 V. Kjørefelt 1
4	99999.000	3.000	-0.030			

Figur 230 Kjørefelt 1, left, Rnl.

	Profil	Bredde	Helling	Metode	Linje	Fri flate
1	-99999.000	0.250	Arv			
2	99999.000	0.250	Arv			

Figur 231 Skulder 1, left, Rnl.

	Profil	Bredde	Helling	Metode	Linje	Fri flate
1	-99.000	3.000	-0.030			
2	-99.000			↕	rund. nor. v. ytre	-2.01 V.Kjørefelt 2
3	99.000			↕	rund. nor. v. ytre	-2.01 V.Kjørefelt 2
4	99.000	3.000	-0.030			

Figur 232 Kjørefelt 2, left, Rnl.

	Profil	Bredde	Helling	Metode	Linje	Fri flate
1	-99.000	0.010	13.000			
2	28.334	0.010	13.000			
3	Brudd					
4	28.334	0.000	0.000			
5	32.881	0.000	0.000			
6	Brudd					
7	32.881	0.010	13.000			
8	99.000	0.010	13.000			

Figur 233 Kantsteinsvis, left, Rnl.

	Profil	Bredde	Helling	Metode	Linje	Fri flate
1	-99.000	0.090	0.000			
2	28.334	0.090	0.000			
3	Brudd					
4	28.334	0.000	0.000			
5	32.881	0.000	0.000			
6	Brudd					
7	32.881	0.090	0.000			
8	99.000	0.090	0.000			

Figur 234 Kantsteinsflate, left, Rnl.

	Profil	Bredde	Helling	Metode	Linje	Fri flate
1	-99999.000	2.900	0.020			
2	-99.000			↔	rund. nor. v fortau	-3.15 V. Fortau
3	28.334			↔	rund. nor. v fortau	-3.15 V. Fortau
4	28.334	0.000	0.000			
5	32.881	0.000	0.000			
6	32.881			↔	rund. nor. v fortau	-3.15 V. Fortau
7	99.000			↔	rund. nor. v fortau	-3.15 V. Fortau
8	99.000	2.900	0.020			

Figur 235 Fortau, left, Rnl.

17.3.2. Right side

	Profil	Flate	Linjeavgrensning	Avstand	Object
1	-99.000	Primærlinje		0.000	
2	99.000	Primærlinje		0.000	

Figur 236 Boundry, left, Rnl.