



Faculty of Science and Technology

MASTER'S THESIS

Study program/ Specialization: Petroleum Engineering	Spring semester, 2011 Open
Writer: Beate Midtun (Writer's signature)
Faculty supervisor: Professor Arnfinn Nergaard External supervisor(s): Bruce Wilson (A/S Norske Shell)	
Title of thesis: Evaluation of hydro acoustic condition monitoring of subsea processing equipment	
Credits (ECTS): 30	
Key words: Hydro acoustics, condition monitoring, Ormen Lange Subsea Compression Pilot, Acoustic Leak and Vibration Detection	Pages: 98 + enclosure: 10 Stavanger, June 8 th 2011 Date/year

EVALUATION OF HYDRO ACOUSTIC CONDITION MONITORING FOR SUBSEA PROCESSING EQUIPMENT



View of the onshore gas processing plant at Nyhamna – the subsea compression test site can be seen in the left lowermost corner. (Shell, 2010)

An evaluation of the benefits potentially gained through performing a technology development project in conjunction with the Ormen Lange Subsea Compression Pilot operated by Shell.

Beate Midtun, 2011

ACKNOWLEDGEMENTS

I would like to express my appreciation and gratitude for all the help and support I have received during the work of writing this thesis.

I would like to thank A/S Norske Shell for the opportunity to take part in the project engineering and development of a real technology development project. Through the last six months I have learnt a great deal, and got an understanding of the organization in Shell. I truly appreciate the sharing culture in Shell and would like to thank all of the engineers who have willingly shared their knowledge and experience. Special thanks are directed at Bruce Wilson, who has been my supervisor through this process, and who has patiently answered all questions asked. Thanks are also directed to Lars Kristian Asbjørnsen, whose support and knowledge about the acoustic detection system has been highly valuable for me to obtain my own understanding.

I would also like to thank Naxys AS in general and Frank Sæther especially, for their support and insight to the project. Frank has been my contact person for the project, and has delivered technical support and solutions, as well as representing Naxys in the project planning.

I would especially like to thank Professor Arnfinn Nergaard with the University of Stavanger. As my teaching supervisor he has patiently reviewed my work several times during the process, and advised on how the thesis could improve along the way. Professor Nergaard is also “to blame” for my increasing interest for subsea technology.

The last, but not least, thank you goes to Morten Wiig Berge, whose daily encouragement and support I could not do without.

Beate Midtun
Stavanger, June 8th 2011

OBJECTIVES AND SCOPE

The objective of this thesis is to evaluate the benefits of performing an extended function test of hydro acoustic sensing technology, for use as a condition monitoring tool for subsea processing operational characteristics and equipment condition in conjunction with the Ormen Lange Subsea Compression Pilot Project (OLSCPP). This objective will be met through:

1. *Describing the equipment function and physics.*
In order to evaluate the testing, a fundamental understanding of the basic physics and equipment function involved is required.
2. *Discussing the test methodic.*
A discussion of why the actual monitoring equipment (and project) is selected for testing, the project planning process, and budget
3. *Preparing a proposal of overall monitoring system layout for the test.*
4. *Identifying key process failure modes of the test objectives (OLSCPP) suitable for acoustic detection and/or identification.*
5. *Preparing an outline project execution plan (PEP).*

Comment 1:

It is planned to perform the commissioning of the OLSCPP during the spring/summer of 2011. As the monitoring study is *not* originally part of the OLSCPP, it needs to adapt to the commissioning schedule and overall pilot project requirement. This means that insight into the OLSCPP commissioning schedule is required in order to plan the testing. Planned start-up of the OLSCPP equipment is in May 2011, thus this thesis will be limited to give an overview on how the testing of the monitoring equipment will be performed.

Comment 2:

The PEP is considered to be proprietary to A/S Norske Shell and will not be published as full version in this thesis. However, a “condensed” version of this document is added as an appendix at the end of the thesis. In this thesis, proprietary information is withheld, to be able to keep the thesis unrestricted.

SUMMARY AND CONCLUSIONS

The project described in this thesis is based on the perceived fact that a need for advancements in monitoring technology results from the development of more complex subsea equipment. An existing type of hydro acoustic leak and vibration detection technology will be tested with the aim of extending its function from leak detection to an application as condition monitoring. This will be done in conjunction with the testing and commissioning of the Ormen Lange Subsea Compression Pilot. An evaluation of the benefits from such testing has been performed based on information and understanding gained through project planning, and through investigation into the function of equipment and physics involved.

The overall conclusion of this evaluation is that the extended function testing of the ALVD (Acoustic Leak and Vibration Detection) monitoring unit, will result in improved knowledge regardless of the test results. The improved knowledge can possibly be used for improving the existing function towards higher sensitivity and level of detail. The potential of developing a multifunctional monitoring system capable of both leakage detection and condition monitoring of several components simultaneously is interesting and deserves to be explored.

Results from the project can be used when deciding whether or not funding for further studies should be rewarded.

The main benefits of the project are;

1. Improved knowledge about the existing function of the ALVD. This knowledge can be used for improvements, most likely in terms of increased sensitivity and level of detail.
2. An indication of the condition monitoring capability range for the ALVD. Understanding the realistic range of capability better will make an improved decision basis for further development.
3. The potential to extend the ALVD function to performance monitoring and recognition of process characteristics, which can help to improve maintenance and intervention management.
4. The potential to develop a multifunction system capable of detecting malfunction or changes in the system, without necessarily identifying the exact failure mode.

Since introduction of failure modes to the test object (the OLSCPP) is not an option, it is understood from the method of testing that the development of a condition monitoring tool capable of positive failure mode identification will not result from the testing described. This is a major limitation.

However, the benefits described above exceed the limitations, making the testing worthwhile. As initially stated, the conclusions are reached after evaluating benefits

and limitations discovered during the project planning and investigation into equipment function and physics. Key factors in the evaluation are described below.

When considering the propagation properties of acoustics in water, it became clear that the largest limitation appear to be reflections and backscattering, which will occur in the test pit. This will make the monitoring unit lose its ability to determine relative direction to the sound source. As a result, the commissioning and test log from the OLSCPP will be all that more important when interpreting the recorded signals.

It was discovered that the monitoring equipment lack capability to accumulate data subsea while transmitting raw data to the topside facility. Although not limiting to the testing described, this is a limitation that will require attention if a new monitoring unit is to result from the testing. During testing, the risk of impacting or disturbing the Compression Pilot is reduced by the monitoring equipment's remoteness to the test object and low power consumption. The system will consist of sensors in the OLSCPP test pit, connected to topside data acquisition units and a computer through 180 m long cables. This setup introduces yet a challenge, as the signals transmitted will be analog. Naxys, the equipment vendor, has not previously used cables of that length for analog signals, thus it raises questions about the signal integrity. If this will be a real challenge or not, is to be experienced during the testing.

Perhaps the largest limitation (and benefit at the same time) to the project is that the testing will be executed within the constraints and boundaries of the Compression Pilot. This means that all activities of the monitoring project will need to be adapted to fit the Compression Pilot schedule and restrictions. The benefit from this setup is that a commissioning log, which will contain detailed information on commissioning activities and parameters, will be generated.

One of the major benefits is that the project can potentially result in the development of a multifunctional system, combining leakage detection and condition monitoring. Even if the project does not result in this outcome, and the only thing gained improved knowledge on the existing function of the monitoring technology, it is concluded that the project will add value.

LIST OF CONTENT

Acknowledgements.....	3
Objectives and scope	4
Summary and conclusions.....	5
List of content.....	7
1. Introduction	10
2. Condition monitoring.....	12
2.1 Introduction to condition monitoring.....	13
2.2 Techniques.....	15
2.3 Acoustic condition monitoring.....	17
2.4 Electromagnetic condition monitoring.....	18
3. Electromagnetic fields in seawater	20
4. Hydro acoustics.....	22
4.1 Sound propagation in seawater	22
4.1.1 The sound velocity	23
4.1.2 Wavelengths and frequencies.....	24
4.1.3 Propagation loss.....	24
4.1.4 Reflection and backscattering.....	26
4.2 Handling acoustics in the test pit.....	26
4.3 Active and passive systems	27
5. The Acoustic Leak and Vibration Detector.....	30
5.1 Hydrophones.....	31
5.2 Software and signal processing	32
5.2.1 General.....	33
5.2.2 Communication	33
5.2.3 Method of analysis.....	34
5.2.4 The user interface.....	35
5.2.5 Directionality.....	35
5.3 Physical description	36
5.4 Test unit description	37
5.5 ALVD limitations.....	38
5.6 Experiences from small scale pump fault detection tests	39
6. The EMF sensing system	42
7. Ormen Lange.....	43

7.1 The subsea Compression Pilot	44
7.2 Pilot main active process units	47
7.2.1 The pump module.....	47
7.2.2 The compressor module	49
7.2.3 The separator module.....	50
7.2.4 The anti-surge cooler module.....	51
7.3 Failure modes	53
7.3.1 Failure modes for the separator and anti-surge cooler	53
7.3.2 Failure modes for the pump module.....	55
7.3.3 Failure modes for the compressor module.....	57
7.4 Other issues of interest	59
7.5 Compression Pilot integrated condition monitoring.....	60
7.6 Pilot project timeline.....	60
8. The project.....	62
8.1 Concept selection.....	62
8.2 Project planning process	64
8.3 Project budget.....	66
8.4 Project timeline	66
9. An offsite pump monitoring test at Tranby	68
10. Testing at Nyhamna.....	70
10.1 HSE at Nyhamna.....	70
10.2 Quality assurance.....	71
10.3 Requirements and regulations	72
10.4 Risks	73
10.5 System layout and installation.....	74
10.6 Test execution	75
10.7 Test success criteria.....	77
10.8 Challenges and limitations	78
11. Benefits and limitations	79
11.1 Concept related benefits	79
11.2 Perceived benefits from successful testing.....	80
11.3 Test concept related limitations	82
11.4 Limitations of future system	83
12. Recommendations for further studies	85

13. Discussion.....	86
Bibliography	87
Abbreviations.....	91
Definitions	92
List of figures.....	93
List of tables.....	95
Equations	96
Appendix 1: Project Execution Plan	98

1. INTRODUCTION

As the complexity of subsea developments increases, a need for advances in monitoring technology arises. Heavier and more expensive equipment are more difficult and costly to intervene on, meaning that assistance in maintenance planning is well worth. A diagnostic tool that can detect failure modes and causes at an early stage can help ensure that components are maintained in time to prevent secondary damages and shut-down. By getting information on causes of potential failures before they actually occur, engineers should be able to tune parameters to avoid equipment failure.

The technology of interest in this thesis is the Acoustic Leak and Vibration Detection (ALVD) technology, delivered by Naxys AS. This technology is currently in use as detection method for leaks and structural vibrations on the Ormen Lange subsea templates. If this technology can be extended to condition monitoring of subsea processing equipment, it can potentially prove to be a valuable tool for maintenance management, as well as process optimization.

A technology development project for the extension of the ALVD's function is being planned over the spring of 2011. Even though sound alone may provide a lot of information, Naxys has identified that a system based on triangulation between acoustic and electromagnetic sensors can give a more detailed view of equipment's condition and performance. The equipment that will be tested in the project is of ALVD technology complemented by electromagnetic field (EMF) sensors. However, in order to keep the scope of the thesis at a feasible level, the main focus will be on acoustic monitoring whereas only a brief introduction to use of EMF sensing will be given.

The information used in this thesis has been gained by taking part in the planning process, the study of literature and discussions with discipline engineers and representatives of the equipment vendor. As part of the planning process, project documents like the project execution plan and a scope of work document has been prepared. A project description with information on concept selection, planning process and project budget is given later on in this thesis.

The Ormen Lange Subsea Compression Pilot is being commissioned during the spring, 2011 and offers a unique opportunity to test the ALVD for potential extension into condition monitoring. It is selected as monitoring object due to its complexity and size, novel technology, and location on land at Nyhamna. By running tests in a shallow pool in controlled environment, availability to the equipment is increased and installation costs are reduced. It is desired to monitor operational characteristics such as cavitations and slugging flow, and equipment condition. Examples of failure modes that can be monitored for are bearing damage and shaft eccentricity. A selection of failure modes and causes suitable for acoustic detection are gathered from the Failure

Modes Effects and Criticality Analysis (FMECA) of the active components in the compression pilot. Discussions with discipline engineers on the OLSCPP team revealed a set of issues that are of special concern, and that is desired monitored. These issues will be discussed later on in this thesis.

An important assumption for this project is that all active equipment/processes have got an acoustic signature. By analyzing sound caught by an array of hydrophones, it should be possible to recognize operational characteristics and equipment condition, and from this determine the need for maintenance and the operational lifetime. The use of the ALVD technology for condition monitoring offers some special benefits. One of them is versatility – the method can detect a number of failure modes that can occur. Another is that because the sensors are remote and non-intrusive they can be replaced or maintained without affecting the equipment that is being monitored. (Haugen & Naxys, 2004)

2. CONDITION MONITORING

Maintenance is the key to well functioning equipment and systems. It can be defined as *“the recurring day-to-day, periodic or scheduled work required to preserve or restore facilities, systems and equipment to continually meet or perform according to their designed functions”*. (Johnson, 2002) There are several strategies to maintenance, which can be divided into three groups, namely breakdown maintenance, fixed-time interval or planned maintenance and condition-based maintenance. (Peter J. Tavner, 2008) This division is shown in figure 2.1.

Breakdown maintenance is characterized by the lack of scheduled inspections and maintenance – a “run to it breaks” strategy. This strategy requires the maintenance crew to have a large variety in skills, as they will have to deal with breakdowns frequently. It also requires the company to keep a spare for “everything” in order to avoid prolonged shutdowns. (Johnson, 2002) (Peter J. Tavner, 2008) This results in higher maintenance costs as the spare inventory is larger than with other strategies, and as it requires a large maintenance crew to meet the requirement of skill variety.

The fixed-time or planned maintenance strategy can include monitoring to some degree to help planning the maintenance, whereas the condition-based maintenance strategy requires a commitment to monitoring. (Johnson, 2002) (Peter J. Tavner, 2008)

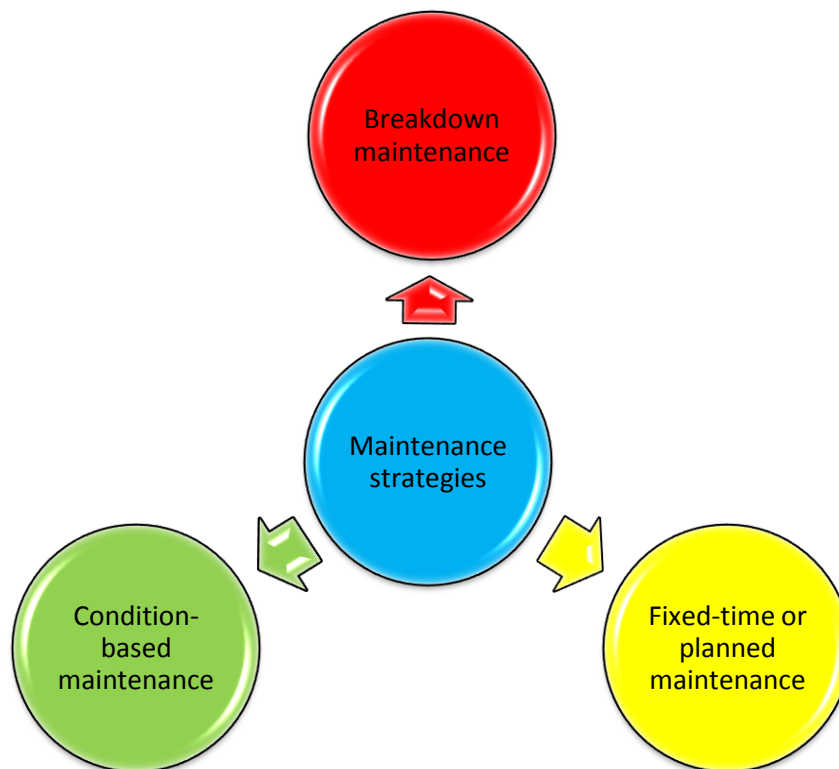

Figure 2.1: The maintenance strategies, as divided by Peter J. Tavner. (Self made after (Peter J. Tavner, 2008))

The project in this thesis falls within the condition-based maintenance strategy. It is perceived that a wider diagnostic picture would improve the knowledge on equipment function and processes, and that it is therefore valuable for maintenance management. The following sections (2.1-2.4) introduce condition monitoring and a selection of techniques.

2.1 INTRODUCTION TO CONDITION MONITORING

The ISO standard's definition of condition monitoring is "acquisition of data that indicate the state of a machine." (ISO 13372:2004, 2004) Peter J. Tavner gives a similar definition: "By condition monitoring we mean continuous evaluation of the health of plant and equipment throughout its serviceable life" (Peter J. Tavner, 2008). In this thesis however, condition monitoring is defined as somewhat different. This definition is: "the continuous evaluation of equipment health and process behavior for the purpose of determining equipment integrity and optimizing performance".

The main reason for applying condition monitoring is to "*find accurate, quantitative information on the present condition of the equipment*" (Mechefske, 2010) and to optimize the performance of the equipment. In other words, the purpose of condition monitoring is to detect and recognize failure modes and causes at an early stage, so that necessary maintenance can be performed, or parameters (such as i.e. flow rate) can be tuned to avoid failure, at least for a short period of time. This gives the operator of the equipment more freedom to schedule the maintenance in the most cost efficient and convenient matter. An example is that it can be possible to avoid failure during the winter months, and then perform the maintenance during spring when the weather conditions are typically more benign. (Peter J. Tavner, 2008) Optimization of performance can also affect the serviceable lifetime and need for maintenance, to the operators benefit.

"Condition monitoring is a multidiscipline (...) that should be integrated into a wider maintenance and system supportive perspective". (Rao, 1996) If followed, this can ensure cost effective and logical decision making, with decisions made on information about the equipment health. The project in this thesis aims at extending existing (hydro acoustic) leak detection technology into a condition monitoring technology applicable for subsea equipment. From "Handbook of Condition Monitoring" (Rao, 1996) we get the following requirements for performance monitoring:

1. The system should be stable in normal operational condition
2. Measurements are taken either manually or automatic

Rao also states that if these requirements are met, any change from the normal behavior could be easily recognized, and potential failures can be revealed at an early stage.

There are a number of potential benefits from applying condition monitoring (Peter J. Tavner, 2008), such as;

1. Improved knowledge on the equipment condition, resulting in optimal equipment performance.
2. Reduced spare parts inventory and reduction in secondary damages as a result of poor maintenance planning.
3. Improved risk management – potentially resulting in less downtime.

Other advantages may be that operating efficiency and safety may be improved, and that elimination of chronic failures may result in maintenance cost savings. (Peter J. Tavner, 2008) (Mechefske, 2010) The frequency of maintenance may also be reduced as condition monitoring allows time for maintenance planning. (Rao, 1996) In most cases, well maintained equipment will have an extended operational life time, and increased availability and reliability. For hard accessible equipment, such as subsea equipment with a high degree of complexity, this is important, as it can impact the economics and development of a field. For subsea equipment there is also a potential benefit from early failure detection with regards to leakages.

There are potential disadvantages with condition monitoring as well. Two of the disadvantages are;

1. High costs of purchase and running the monitoring equipment.
2. The cost of training personnel to operate the monitoring equipment and interpret the data gathered.

The need for qualified personnel to run and maintain the monitoring program introduces higher stakes in keeping personnel “onboard” in the company, as new personnel will require training. Monitoring based on deviations from normal operation will require long run-in times to collect equipment histories and set baseline signatures – trends during normal operation – to be used for comparison. The project management will need to be strongly committed to condition monitoring of the equipment. (Mechefske, 2010)

Traditionally, monitoring of subsea equipment and processes has been performed by sensors mounted directly on the equipment of interest, so-called non-remote sensors. Typical sensors are flow meters, temperature and pressure sensors, and accelerometers for direct vibration monitoring. (Haugen & Naxys, 2004) Common for these sensors is the requirement for cabling and structural interfaces, which in many cases represent technical challenges. Other technical challenges are related to maintenance and installation of structural mounted sensors. Due to these technical challenges and the costs of resolving them, combined with the industry’s lack of confidence in condition monitoring as an optimization tool for operations, subsea installations have not seen the same emphasize on condition monitoring as for topside equipment.

Recent evolvments in the oil and gas industry have given birth to an increase in complexity of subsea structures, which results from the desire of enhancing recovery from existing field, but also to enable development of smaller fields (e.g. as satellites tied back to a common host). Subsea process stations with separators, pumps and even compressors are slowly being introduced, and the introduction of complex systems creates the need for advances in monitoring systems as well. One of the incentives to develop condition monitoring tools for subsea use is the difficulty and cost of retrieving subsea equipment for maintenance and replacement.

2.2 TECHNIQUES

There are many techniques for condition monitoring. A few examples are thermography, inductive sensing, noise and vibration monitoring. (Rao, 1996) This section will not describe all of the techniques available, but rather split them into more general groups. The groups are divided after the method to which they belong, as listed below;

1. Vibration monitoring
2. Wear debris analysis
3. Visual inspection
4. Noise monitoring
5. Environmental pollution monitoring

The division is illustrated in figure 2.2. It can be argued that vibration and noise can be monitored by the same technique and therefore belong in the same group. This is true for the sensing equipment described in this thesis, as it measures both “normal noise” and vibration induced noise frequencies. However, in conventional vibration monitoring, accelerometers mounted directly to the equipment is normally used. Thus conventional vibration monitoring raises questions about optimal mounting locations for sensing and practicality combined, and about how many sensors that are needed for optimal monitoring. The technique is based upon the fact that nearly all machinery vibrates, and that the link between equipment vibration and condition can be easily measured and analyzed. The monitoring principle uses that different mechanical processes vibrate at different frequencies, meaning that the frequencies picked up can be separated and analyzed. From this it is understood that advance warnings can be made, and that diagnostic capabilities can be enhanced. (Rao, 1996)

Noise monitoring is based on “listening” to the equipment, and comparing the frequencies with normal operation baseline signatures. As section 2.3 is devoted to acoustic condition monitoring, noise monitoring will not be further described here.

Wear debris analysis utilizes i.e. magnetic plugs, filter systems, centrifuges and particle counters. The debris offers a range of information based on amount and size distribution of debris, as well as particle shape and chemical analysis. From this it is possible to get an indication of the failures nature. (Rao, 1996)

Visual inspection is (at least for onshore equipment) the cheapest and most obvious way of monitoring equipment. Corrosion, leaks and cracks can often be detected before critical failure is reached. For subsea equipment it is slightly more complicated. Here, the visual inspection must be performed by either camera mounted on a ROV, or by permanently installed cameras at the seabed. Visual inspection of subsea equipment meets challenges such as lack of light and marine growth. Even though the impact of these challenges can be reduced by providing light and removal of marine growths, visual inspection is not optimal for subsea applications. (DNV, 2010)

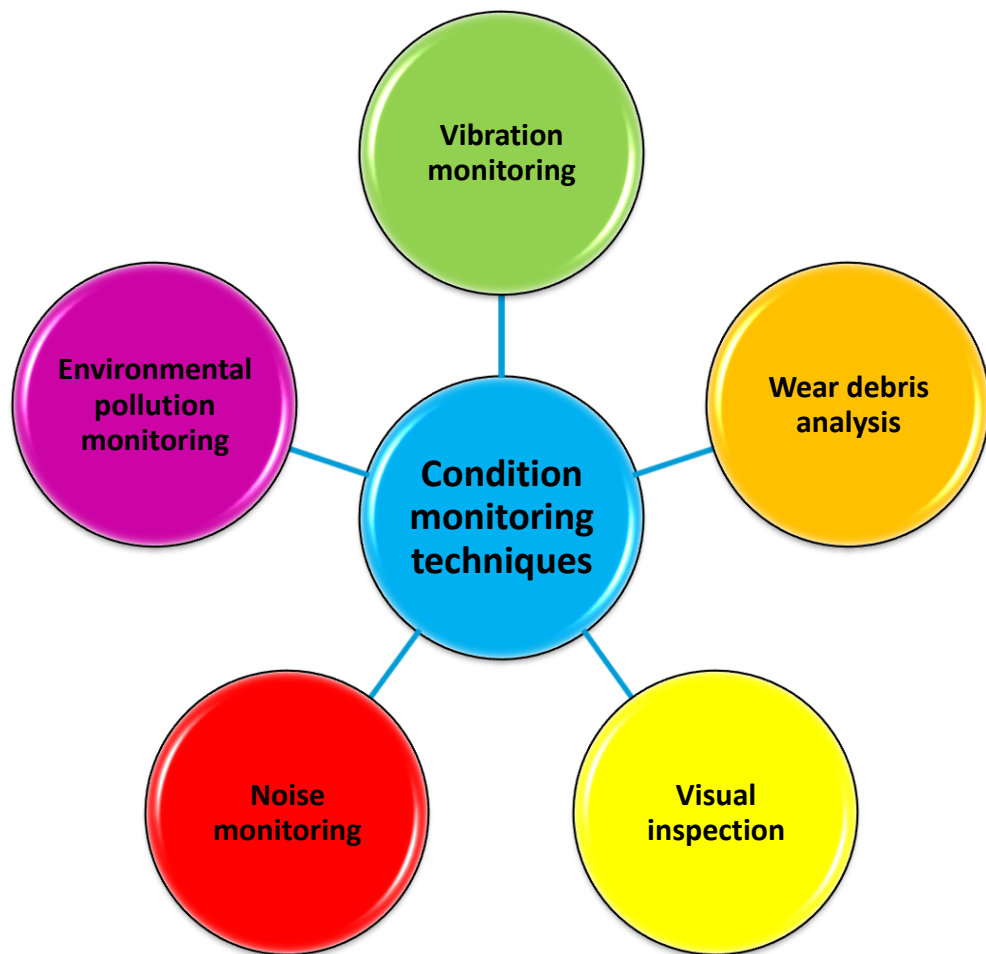

Figure 2.2: The different groups of condition monitoring techniques. (Based on (Rao, 1996)). The technology considered in this thesis can be said to combine vibration and noise monitoring into one technique, where vibrations are indirectly monitored by utilizing vibration induced noise frequencies.

Environmental monitoring is the monitoring of pollution in air, water or soil. (Rao, 1996) For subsea applications we find a Recommended Practice (by DNV), which describes available leak detection technologies and how to select which technology to

be used. (DNV, 2010) Some of the available technologies that are available are i.e. bio sensors (monitoring of marine organisms' response to pollution), optic cameras (visual method), fluorescent methods (excitation of molecules which leads to emission of light) and acoustic methods. It can be noted that environmental monitoring is utilizing methods from other monitoring techniques.

2.3 ACOUSTIC CONDITION MONITORING

Noise and vibration signals from equipment can contain vital information on the equipment processes, thus techniques to pick up and process these signals prove valuable in condition monitoring. The fundamental basis of acoustic monitoring of equipment is that equipment in good condition has characteristic features in noise and vibration frequencies. A machine or a piece of equipment does not break without giving some sort of warning, e.g. through an increase in vibration or change in noise pattern. This is utilized in acoustic condition monitoring. A baseline signature is recorded during normal operation, to which all later recordings are compared. Variations outside a pre-set threshold will indicate that something is changing within the equipment.

As a failure or abnormal behavior develops, changes in frequency occur. Changes in frequency amplitude may for instance be a sign of wear, eccentricity or imbalanced mass. Processing of the acoustic signal may reveal the cause of the failure, and potentially also which component that has failed and in what way. (Norton & Karczub, 2003) This study concentrates on monitoring through sound pressure. On land sound pressure is detected by microphone, whereas it is detected by hydrophones in water. In water, the sound pressure is seen as variations around the hydrostatic pressure.

Acoustic monitoring is not a novel technology. Acoustic emission (AE) monitoring is used as crack detection in ship's hulls and other metal structures, and also for monitoring of flow patterns, pump function and cavitation detection. The acoustic energy measured with AE sensors are sound pulses produced during crack growth. The pressure pulses origins as releases of strain propagating through the metal. Even if AE technology is known, there are differences between this and the technology described in chapter 5. The most important is the remoteness to the monitoring objects. Whereas AE sensors have to be mounted directly on the monitoring objects, hydrophones are set back from them, without any physical connection. (Smith, 2006)

The science of underwater acoustics is often referred to as hydro acoustics. In this thesis however, it will just be referred to as acoustics. As a science, it saw its first practical realizations in the beginning of the 20th century. The technology was allowed to evolve and today acoustic waves are utilized in a number of different areas such as military/naval applications, fishery, measurements of marine environment,

and transmission of signals. (Lurton, 2002) By using hydrophones acoustic condition monitoring allows for the use of remote non-intrusive sensors, which makes it well suited for subsea applications.

An acoustic subsea condition monitoring system will make the baseline signatures utilizing the acoustic propagation properties of the ocean and the information generated from dynamic processes within the equipment. The acoustic propagation properties of the ocean are described in chapter 4.

2.4 ELECTROMAGNETIC CONDITION MONITORING

By itself, electromagnetic condition monitoring will not be treated in this thesis, thus it will not receive the same attention as the acoustic monitoring technique. However, the use of electric sensors can include ground-failure detection and circuit-breaker monitoring. It should be noted that both of these uses still needs to be verified through experimental tests. Many failures will have a unique electromagnetic signature, thus the field emitted from the equipment can be used for diagnostics. (Naxys AS (Frank Sæther), 2011) When used as a complement to acoustic sensors, it can be used in signal processing, as will be the case for the project described in this thesis.

The method that will be used in this project is based on using UEP (Underwater Electric Potential) sensors to monitor the electromagnetic field emitted from the equipment. It can be assumed that all equipment and processes have got an electric and a magnetic field. This field can be induced by power running through a cable or as a potential between two different materials. The latter may be induced from rotating equipment e.g. from an aluminum propeller on a steel submarine, the effect being similar to a small seawater battery. (Naxys, 2011)

As mentioned above, the UEP sensors will be used as complement to the acoustic monitoring system. When both the electric supply frequency and acoustic mechanical frequency are known, the slip ratio (performance loss, see definitions) for the rotating equipment can be determined. The slip ratio is important for determining load, torque and general performance of the equipment. In addition to this, the acoustic signature of a healthy piece of equipment, are not always easily recognized, whereas the electric field is. This means that the electric signatures can be used to improve the analysis algorithms for the acoustic signal. (Naxys AS (Frank Sæther), 2011)

The technique of using UEP sensors as complement to acoustic sensors to improve signal filtering has been verified at Tordis IOR, where the water injection pump (WIP) and the multiphase pump sit fairly close and is hard to distinguish from each other. The slip ratio can also be used to ensure operation of the electric motor within operational limits defined by the manufacturer, and indicate the rotational resistance in the equipment. (Gundersen, 2004) Calculation of the slip ratio at the Troll Pilot

WIP is given as an example below.

Example:

In this case, supplied power frequency (SPF) was 39.60 Hz, and the measured frequency (MF) by UEP sensors was 39.72 Hz. From this, the rotational speed, in rotations per minute (RPM) and slip could be calculated. Equation 2.1 yields the calculation of rotational speed of the WIP, and from equation 2.2 the slip ratio can be calculated:

$$Speed = SPF [Hz] \times 60 \left[\frac{Seconds}{min} \right] \quad (Eq. 2.1)$$

$$Speed = 39.60 [Hz] \times 60 \left[\frac{Seconds}{min} \right] = 2376 RPM$$

$$Slip = \frac{MF [Hz] - SPF [Hz]}{MF [Hz]} \times 100 \% \quad (Eq. 2.2)$$

$$Slip = \frac{39.72 [Hz] - 39.60 [Hz]}{39.72 [Hz]} \times 100 \% = 0.3 \%$$

The curve in figure 2.3 is made from data gathered at the Troll Pilot WIP. It is input to the calculation above. As one can see, there are two distinct peaks, one at 39.60 Hz, and one at 39.72 Hz. These peaks represent the supplied power frequency and the measured acoustic frequency of the operating pump, respectively.

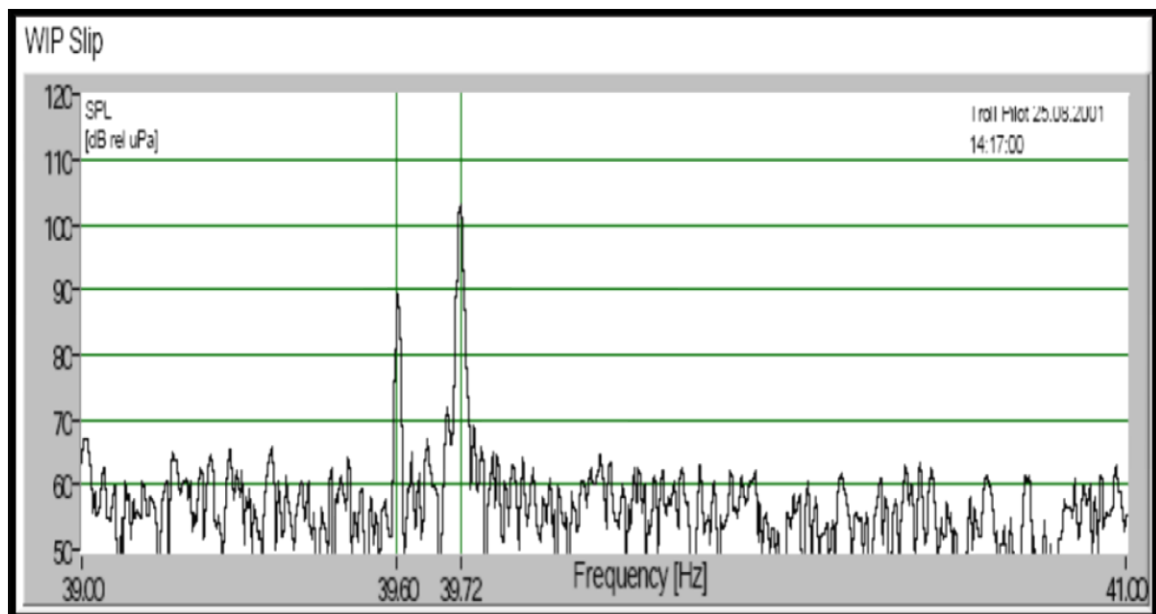

Figure 2.3: WIP slip ratio from Troll Pilot. (Gundersen, 2004)

3. ELECTROMAGNETIC FIELDS IN SEAWATER

This chapter gives a short introduction to the propagation of electromagnetic fields. Unlike acoustic waves, EM waves can move from one propagation medium to another without major signal losses and reflections. This means that EM applications are not subject to any limitations with regards to echoes. An illustration of the EM waves capability to travel in different propagation mediums are given in figure 3.1.

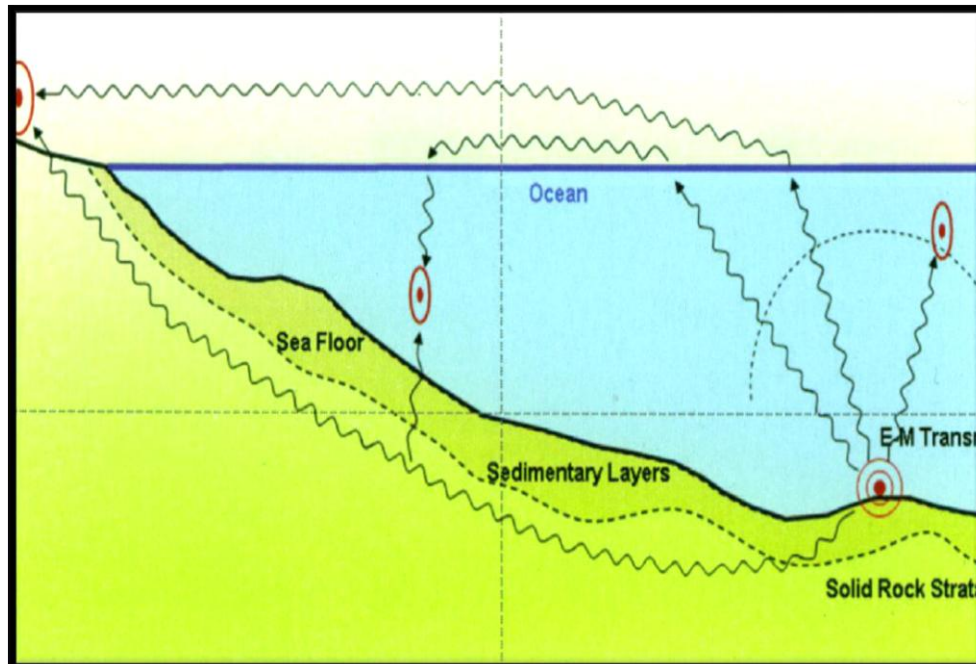

Figure 3.1: EM waves capability to travel through different propagation mediums. (<http://www.wirelessfibre.co.uk>)

Since the early days of the radio, underwater EM communication and field propagation have been investigated and during the 1970's it received an increasing amount of attention. The ocean has got high permittivity and conductivity, thus the EM field propagation in seawater is different from in air. The propagation loss in seawater is high, and increases with the wave's frequency. This propagation loss is affected by conduction of the electric field component through the seawater. (<http://www.wirelessfibre.co.uk>)

The high propagation loss makes communication via EM waves impractical, and prevents it from being an optimal solution. However, because this project only utilizes the UEP, and because the distances over which the waves are needed to travel (from the objects where they are produced and to the sensors) the consideration of EM fields in seawater is applicable, as no major information will be lost.

When propagating through seawater, EM waves are defined through Maxwell's four equations (equation 3.1 – 3.4).

$$\nabla \cdot \mathbf{D} = \rho_f \quad (\text{Eq. 3.1})$$

$$\nabla \cdot \mathbf{B} = 0 \quad (\text{Eq. 3.2})$$

$$\nabla \times \mathbf{E} = -\frac{\partial \mathbf{B}}{\partial t} \quad (\text{Eq. 3.3})$$

$$\nabla \times \mathbf{H} = \mathbf{J}_f + \frac{\partial \mathbf{D}}{\partial t} \quad (\text{Eq. 3.4})$$

In these equations \mathbf{D} = electric displacement vector, ρ_f = free electric load per volume, \mathbf{B} = magnetic field, \mathbf{E} = electric field, \mathbf{H} = magnetic intensity and \mathbf{J}_f = free electric density.

When sufficiently small variations in EM fields are seen with time, the fields are considered to be quasi-static. When this occurs, the second derivative of equation 3.1-3.4 can be neglected compared to the first order derivative. It can be concluded that the quasi-static fields are independent from the propagation medium's dielectric constant. This is considered to be the case in the test pit at Nyhamna, thus it is utilized in the It is assumed that this will be the case in the test pit, thus this feature is used in the signal processing of the EM fields from the OLSCP, as calculations are simplified. (Naxys, 2011)

4. HYDRO ACOUSTICS

Above the water, it is common to utilize electromagnetic waves for most surveying and communications. In seawater however, the most effective method for transferring information is acoustic waves. (Lurton, 2002) The term hydro acoustic is the study of mechanical vibrations, or sound, propagated in water. Hydro acoustics will henceforth be referred to as acoustics. (FederationofAmericasScientists, 2011)

The capacity of sound in water compared to sound in air is connected to the propagation properties of pressure in water, which among other parameters contributes to the speed of sound. Having a sound velocity in water nearly 5 times higher than in air, acoustic waves can reach much higher energy levels and see less propagation loss (for definition see section 4.1.3), than the EM waves. (Lurton, 2002)

4.1 SOUND PROPAGATION IN SEAWATER

Sound waves are basically longitudinal waves, characterized by their back and forth oscillation of fluid molecules in the direction of the wave. As the sound wave passes a certain point, the oscillation results in alternating compression and extension of the molecules. It is the excitation of molecules rather than fluid movement that is moving with the speed of sound and thus, as the molecules do not move far from their initial position, the displacement of fluid particles is zero. (Raichel, 2006) This means that in order for an acoustic wave to propagate, it needs the support of an elastic material, which for this project will be seawater. (Lurton, 2002) The need for support from the propagation medium, results in the sounds lack of ability to successfully transfer from one medium to another. From an acoustic wave hitting the ocean surface, only a small fraction would enter the air, whereas most part of hit would simply be reflected.

The acoustic waves are characterized by the amplitude of the “local motion” of the individual particle in the propagation medium, the corresponding particle velocity and the resulting acoustic pressure. The acoustic pressure can be seen as variations around the hydrostatic pressure. (Lurton, 2002)

When propagating through a medium such as gas or liquid, the behavior of the acoustic waves is controlled by the laws of fluid mechanics. The utilization of a plane wave model is the easiest way to describe the propagation of acoustic waves, (Lurton, 2002) The waves can be described by using the Helmholtz equation (equation 4.1), where p is used for acoustic pressure, t for time, and $c(x,y,z)$ as local propagation velocity in a Cartesian coordinate system with axes x , y and z . (Lurton, 2002)

$$\Delta p = \frac{\partial^2 p}{\partial x^2} + \frac{\partial^2 p}{\partial y^2} + \frac{\partial^2 p}{\partial z^2} = \frac{1}{c^2(x,y,z)} \frac{\partial^2 p}{\partial t^2} \quad (\text{Eq. 4.1})$$

If velocity can be considered as a constant, then $c(x,y,z) = c$, and if propagation only exists in a single direction x equation 4.1 is reduced to equation 4.2.

$$\Delta p = \frac{1}{c^2} \frac{\partial^2 p}{\partial t^2} \quad (\text{Eq. 4.2})$$

From equation 4.1 and 4.2 we can derive an expression for plane waves, by considering a sinusoidal wave of frequency f with constant amplitude. This is valid if the wave's phase only depends on a single Cartesian coordinate, in this case x . (Lurton, 2002)

Acoustic waves, when propagating in seawater, are subject to a number of limitations, where the most important is the propagation loss. Propagation loss is the phenomenon where the amplitude of a wave decreases over the travelling distance from the source. The propagation loss is a combined result of absorption and geometrical spreading. This is described in section 4.1.3.

4.1.1 THE SOUND VELOCITY

The speed of sound is dependent on the medium in which it travels. The more dense the medium, the easier it is for the molecules to transmit the sound energy, and the velocity increases. This is why the speed of sound in water, compared to in air, is much higher. (David A. Bies, 2003) In any conducting material it is found that the speed of sound wave propagation is independent of the frequency. (F. Alton Everest, 2009) The speed of sound in seawater depends on depth (z), salinity (S) and temperature (T). This dependency is presented in a simplified equation (eq. 4.1) by H. Medwin in the book "Fundamentals of Ocean Acoustics" by L. M. Brekhovskikh as below:

$$C = 1449.2 + 4.6T - 0.00029T^3 + (1.34 - 0.010T)(S - 35) + 0.016z \quad (\text{Eq. 4.3})$$

This equation is valid for the following ranges of T , S and z : $T = \{0^\circ\text{C} - 30^\circ\text{C}\}$, $S = \{0\text{‰} - 45\text{‰}\}$ and $z = \{0\text{ m} - 1000\text{ m}\}$. (L. M. Brekhovskikh, 2003) At Ormen Lange the mean temperature is -0.9°C , meaning that the field is outside the range of the equation. However, it can be assumed that any changes in sound velocity can be neglected for the Ormen Lange field. This is due to the facts that the equipment is installed at the same depth (859 m), a narrow range of temperatures ($-1^\circ\text{C} - 4^\circ\text{C}$) and a salinity that is close to constant ($\sim 35\text{‰}$), meaning that any variations in sound velocity will be too small to impact on acoustic detection with the ALVD.

For the test site at Nyhamna, the water in the test pit is expected to be kept at constant temperature by circulation of seawater. Depth and salinity can also be assumed constant. From this, the sound velocity can be assumed constant. With an average sound velocity, the sound waves travel approximately 1480 m in a second. The travelling distances the waves will see in the test pit (less than 30 m) are only

2.02 % of this, meaning that any variations in sound velocity up to ± 10 m/s will result in only minor changes in travelling time. The error of an assumed constant sound velocity is therefore negligible.

In many applications, knowledge of sound velocity profiles is needed. (A sound velocity profile is defined as sound velocity plotted as a function of sea depth.) This could be i.e. in order to optimize detection capabilities. In order to simplify the understanding of acoustic propagation, the sound velocity profile is often assumed to be layered. This is not accurate, as the velocity profile can vary in space due to geographical and environmental anomalies such as i.e. currents. (Lurton, 2002) For the case of Ormen Lange, currents could potentially be an issue. Two of the effects induced by currents are variations in sound velocity and amplitude instabilities. (Lurton, 2002)

4.1.2 WAVELENGTHS AND FREQUENCIES

The range of frequencies used in hydro acoustics is, depending on the application, commonly 10 Hz – 1MHz. A 10 Hz acoustic wave travelling at 1,500 m/s will have a wavelength of 150 m. Similarly a 20 Hz wave at the same velocity will have a wavelength of 75 m. This can easily be calculated from equation 4.2, where λ = wavelength, c = sound velocity and f = frequency. The wide range of frequencies (and therefore wavelengths), corresponds to different physical processes – both for wave propagation, and the acoustic system. (Lurton, 2002) There are four main constraints with regards to frequency selection for a specific application. These are: 1) damping effect of acoustic waves in water, 2) acoustic response of target, 3) the transducers' directional selectivity as a function of increased frequencies, and 4) the physical size of sound sources. (Lurton, 2002)

$$\lambda = \frac{c}{f} \quad (\text{Eq. 4.4})$$

$$\lambda = \frac{1,500 \frac{\text{m}}{\text{s}}}{20 \text{ s}^{-1}} = 75 \text{ m}$$

Hydrophones used for this project are split in two groups, medium and high frequency. They operate within frequency ranges of 500 Hz – 20 kHz and 20 kHz – 500 kHz. As can be noticed this covers half of the range mention at the top of this section. More on hydrophones can be found in section 4.3 and 5.1.

4.1.3 PROPAGATION LOSS

Constraining the amplitude of acoustic signals, propagation loss is a key parameter for acoustic systems. Commonly, propagation loss is referred to as attenuation. This however, is not entirely correct, as attenuation (absorption) is only one adding factor to the complete propagation loss. In general, *geometric spreading*, and *absorption* of

acoustic energy by the medium (here: seawater) are the main sources of propagation loss. (Lurton, 2002)

In his book “An introduction to underwater acoustics – principles and application” Xavier Lurton uses a sphere as example of geometric spreading: “*An acoustic wave propagating from a sound source will spread the transmitted acoustic energy on larger and larger surface. As energy is conserved, the intensity will decrease proportionally to the inverse of the surface*”. (Lurton, 2002) While the energy is preserved, it is spreading over an increasing area, having the sound source as the center of a sphere. This means that the *intensity* or *acoustic energy amplitude* at a specific point gets smaller the further away from the center one gets. The principal of spherical geometric spreading is illustrated in figure 4.1. In the figure, the green circle illustrates the sound source. The yellow and the red circle illustrate the sound moving away from its source. Note that total energy at the outer edge of each circle is constant. This means that a single point at the outer edge of the red circle will have far less energy than at the green circles edge.

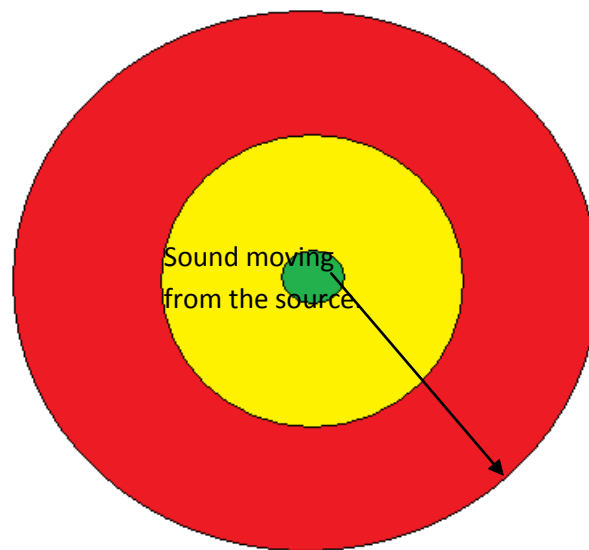

Figure 4.1: Spherical geometric spreading principle (self made after (Lurton, 2002)).

Absorption is a property of seawater, part of the transmitted acoustic energy is absorbed by the seawater, and dissipates (energy decreases) through the seawater's viscosity or chemical reactions. This means that the energy absorbed converts to heat. The absorption is often referred to as *attenuation*. Xavier Lurton further claims that: “*Attenuation is often the most limiting factor in acoustic propagation. (...) In sea water, attenuation comes from*: the viscosity, molecular relaxation of $MgSO_4$ (above 100 kHz) and $B(OH)_3$ ”. (Lurton, 2002) It is possible to calculate a factor for the attenuation,

which depends on the molecular relaxation and depth of the ocean. This factor can be used to correct for attenuation losses. This is however outside of the scope of this thesis.

When evaluating propagation loss, it is common use spherical spreading corrected for attenuation losses as a first approximation. This is only an approximation because geometric spreading cannot be described as spherical alone, but must account for seabed and –surface interfaces as well. In addition one must account for the effect of air bubbles in the seawater (adding extra attenuation), local sound velocity variations and backscattering (see section 4.1.4). (Lurton, 2002)

To a certain degree propagation loss can, like variations in sound velocity, be neglected. This is also due to short travelling distances in the test pit, as well as the assumption that constant distances equal constant propagation loss in the test pit. It is assumed that a distance of at least 1 km is required before it is necessary to consider propagation loss. (Naxys AS (Frank Sæther), 2011)

4.1.4 REFLECTION AND BACKSCATTERING

When the acoustic waves collide with elements in the ocean, the seabed or the surface, reflections and backscattering are generated. The difference between the two is that when the waves hit the “average” bottom or surface of the sea, the echoes come “straight” back towards the sound source, we have reflection. If, however, the waves hit any local objects such as i.e. a whale, or a submarine the echoes will be scattered in all direction as a result of the hit object’s shape. When the echo is scattered in all direction you have backscattering. (Lurton, 2002)

When considering the test pit at Nyhamna where the testing described in this thesis will be performed, there will be echoes. Signals hitting the seawater surface and the pit floor will result in pure reflections, whereas signals hitting pieces of equipment, emergency stairs and the North wall of the pit (which has a rough surface) will result in backscattering and multi-paths (meaning that the hydrophones will receive the sound from many directions). This makes determination of direction towards the sound source difficult. The echoes are expected to be of somewhat smaller amplitude than the primary signals coming directly from the monitoring objects, although this difference will not be enough to separate the two.

4.2 HANDLING ACOUSTICS IN THE TEST PIT

When monitoring in the test pit, the phenomenon described in section 4.1 needs to be handled. The three most important are as following;

1. Variations in the speed of sound
2. Propagation losses
3. Loss of directionality due to echoes

Due to the short distances in the test pit, the speed of sound is assumed to be constant. Any variations due to changes in salinity and temperature are neglected. The sound velocity profile is assumed to be homogeneous over a small area. The assumption of constant sound velocity will give a negligible error in the signal processing.

The propagation loss is assumed to be proportional to the speed of sound over a length of 1 km, and so it is assumed to be negligible over the short distances in the test pit. Like for the speed of sound, this will not add any noticeable error in the signal processing.

The most visible phenomenon in the signal processing is echoes. It is expected that a lot of echoes will be seen in the test pit, as the sound will ricochet of the wall, the floor and the seawater surface. This will result in the sound hitting the hydrophones from every possible direction, by so-called multi-paths. The result of this is that determination of the relative distance and direction to the sound source difficult. The solution to the echo challenge will be to look at a frequency spectrum and its variations over time in the analysis, and correlating this with the known data from the commissioning log. This will assist in getting a sense of direction, and the source of the sound.

4.3 ACTIVE AND PASSIVE SYSTEMS

Acoustic systems can be active or passive. The active acoustic system is identified from its function. The principle is that the equipment transmits a signal, which is propagated through the water, reflected of an object and received by the same system. (Raichel, 2006) In other words, the principle of active acoustics is to make use of echo. This not only done with equipment – some animals, such as whales, have their own built-in “SONAR” (“SOund NAVigation and Ranging”) system. The principle is illustrated by figure 4.2, which shows a whale locating a fish.

The common functions through which all active acoustic equipment can be recognized, is that a signal is generated and transformed from an electrical signal to a sound wave. The sound wave is echoed by the target, picked up by *hydrophones* and transformed back into an electrical signal, which is then processed. (John H. Steel, 2009)

The signal picked up by the hydrophones consists of three components, namely the desired echo from the target, unwanted echoes from elements in the ocean (i.e. seabed, shipwrecks etc.) and the background noise of the sea, which for the northern hemisphere is dominated by shipping. (John H. Steel, 2009)

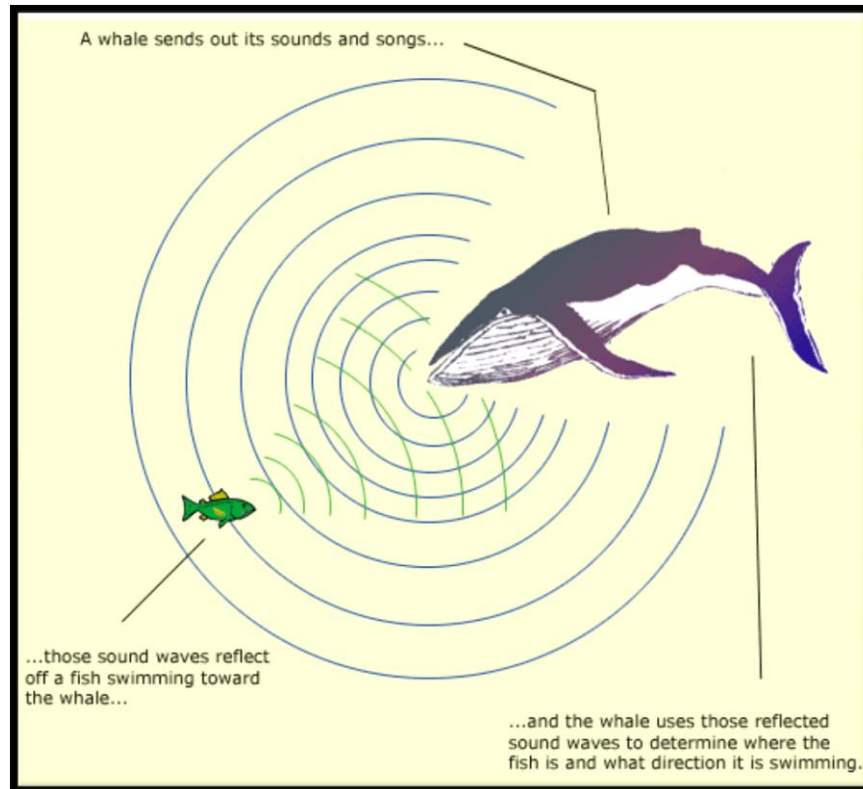

Figure 4.2: Some animals have their own built-in active acoustic system. (exploratorium)

Examples of active acoustic equipment are the SONAR and equipment for echolocation. The technology is, as mentioned above, used mainly by the navy for submarine warfare and detection of landmines and by the fishing industry. In the oil and gas industry, active acoustic systems are used for emergency BOP controls, sand detection and positioning of vessels. One vessel currently using an acoustic positioning system is the drillship West Navigator. (A/S Norske Shell (Wells), 2011)

Contrary to the active systems, the passive systems does not transmit any signals, it just listens. Like for the active system, the hydrophones pick up three different signals; 1) the primary signal from the sound source, 2) unwanted echoes and 3) background noise.

From nature's side, your ear serves as a good example of a passive acoustic system. When having a conversation in a crowded and noisy room, you select what you would like to listen to. This does not mean that you don't pick up all sounds in the room, but you filter out what you're interested in, such as the conversation you are having. In the same way you can also filter the magnitude (i.e. distinguish a whisper from a shout) and determine the direction of a sound. With the right signal processing algorithms, this is something that can be achieved by using hydrophones as well.

A hydrophone represents the listening part of the active sonar, and it is the main core of a passive system. The only difference from a microphone is that it is designed to

function under water. They are designed to transform an acoustic wave into an electrical signal, and are often capable of working in a wide band of frequencies. The latter is due to the lack of need to be tuned to a specific resonance frequency. A single hydrophone will not give you directionality of the sound source, but by arranging a number of hydrophones in an array this is not problematic. (Lurton, 2002) The principle of how to determine the direction of a sound source will be further discussed in its own section, when the specifics of Naxys equipment are investigated.

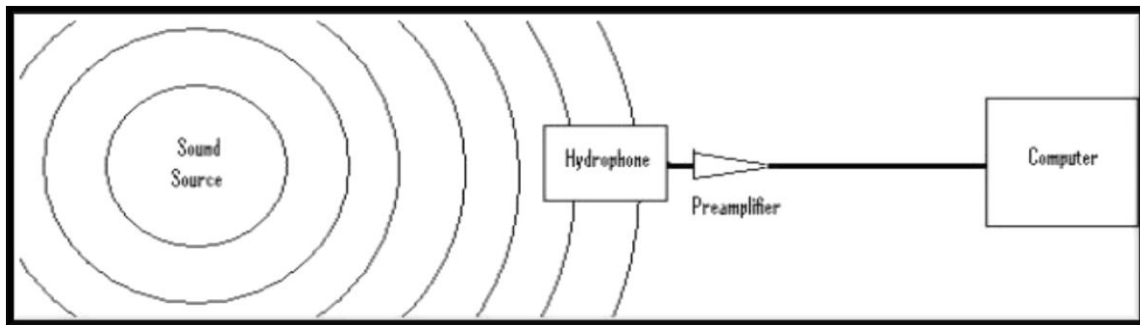

Figure 4.3: The principle of the hydrophone's function. (L. Galli)

5. THE ACOUSTIC LEAK AND VIBRATION DETECTOR

The acoustic monitoring equipment considered here is delivered by Naxys AS. This section provides an overview on the equipments functions, layout and specifications. Since the functional aspect of the full-scale Ormen Lange and the test unit to be used at Nyhamna is approximately the same, the content in this chapter will be on the full scale ALVD. A separate description of the test equipment will be given in section 5.4 and in chapter 10.

Experiences with Naxys' equipment have shown that sounds from subsea installations carry a lot of information. The equipment is currently used for monitoring the water injection pump at Troll Pilot, the export riser base at Åsgard B and for monitoring of both water injection and multiphase pump and the de-sander unit at Tordis. At the Ormen Lange field, the acoustic monitoring system is installed at the subsea templates, where they monitor for leaks and structural vibrations. In the case of any leaks, information on leak location and magnitude can be provided. This is also the case for valve malfunctions and structural vibrations, assuming that they are outside a pre-set threshold. (Abrahamsen J.)

It should be noted that even if the ALVD is currently installed for monitoring of pumps at Tordis and Troll Pilot, the technology is not matured enough to be provided as a remote subsea condition monitoring unit. Through testing in conjunction with the commissioning of the OLSCPP, it can potentially take a step forwards towards such a qualification.

The ALVD system consists of a subsea unit and a topside computer. The subsea unit contains the sensor and the pressure compensated electronic system, for data collection, analysis and communication. The topside computer is equipped with software for user interface and is also used for storage and presentation of the data transferred from the subsea unit. (FMC, Bjørge, & Statoil, 2010)

Figure 5.1 is a general overview of the ALVD system with a topside computer and a subsea unit as installed at the Ormen Lange templates. The acronyms in the figure relates to software, means of communication and signal processing. As an example, TPU means Topside Processing unit, and SEM means Subsea Electronics Module.

The basic system function of the ALVD is that it detects, and record, acoustic energy. The recorded energy pulses are then converted into electric pulses. The pulses are compared to a reference baseline signature. Deviations from the baseline signatures outside a predefined threshold will set of a warning in the user interface. The interface will show the type of alarm – leak or vibration – and in which area of the template the deviations have occurred.

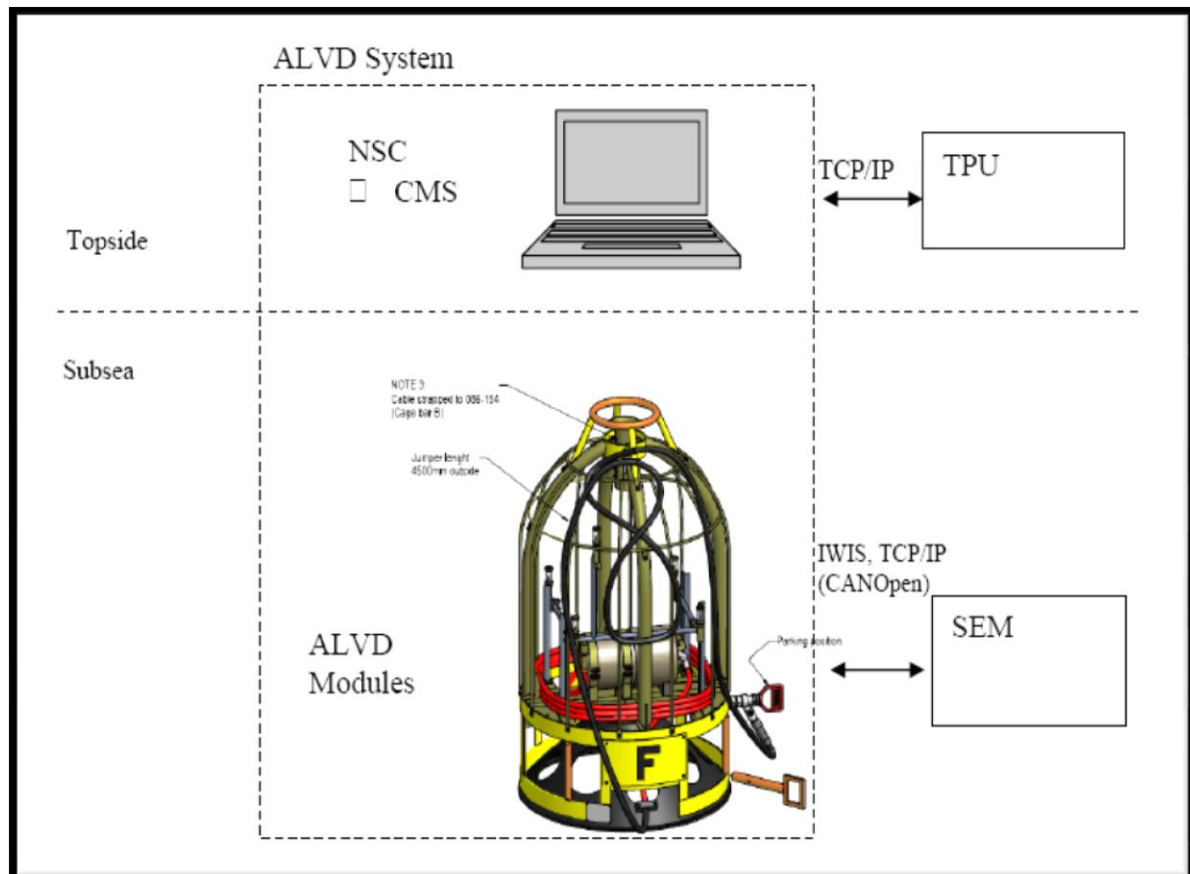

Figure 5.1: General overview of the ALVD system installed at the Ormen Lange templates. (StatoilHydro - Hydro Oil & Energy Projects, 2008)

5.1 HYDROPHONES

The sensors used for acoustic monitoring are hydrophones. As introduced in section 4.3 a hydrophone is a microphone designed for underwater function. Because acoustic energy is unable to travel through mediums with great differences in density, the hydrophones are filled with a density close to water. The hydrophones mounted at the ALVD and to be tested in this project, are filled with oil. The oil prevents water from entering the hydrophones. (Naxys AS, 2011)

In order for a hydrophone to be used in the ocean, it must be “*seaworthy*” meaning that it needs to withstand corrosion, bio fouling and be able to cope with large hydrostatic pressures (pressure at Ormen Lange is approximately 85 bar). Because regular inspection and maintenance is costly and impractical it is also required to be reliable. (Caruthers, 1977) If a hydrophone fails in the ALVD, a message will appear in the user interface.

The hydrophones typically consist of piezoelectric ceramic elements. The elements change dimensions as a result of a mechanical force resulting from the sound pressure. The deformations result in the production of electric fields with magnitude

corresponding to the applied force. As an alternative to using piezoelectric hydrophones, fiber optic sensors can be used. One incentive for this is that it allows submerging only a minimum of electric components. This can avoid problems with water penetrating the electronic containers. In a fiber optic hydrophone the acoustic energy works on the face of the cylinder. The fiber optic fiber is lengthened and shortened due to the sound pressure, and by using light polarization the amplitudes of the acoustic frequencies can be measured. (Haugen & Naxys, 2004) (Gundersen, 2004)

To optimize the sensitivity of the ALVD, sensor arrays working in different ranges of frequencies are configured. This will also provide directionality and proximity sensitivity. There are three ranges of frequencies, low (LF), medium (MF) and high (HF). The low range is dominated by structural vibrations and rotational malfunction. These two are also covered in the medium range, together with valve operation. The high frequency range covers leakage and sand detection. It is also expected that cavitation can be detected within this range. Figure 5.2 shows the frequency ranges and the information that they contain. (Haugen & Naxys, 2004)

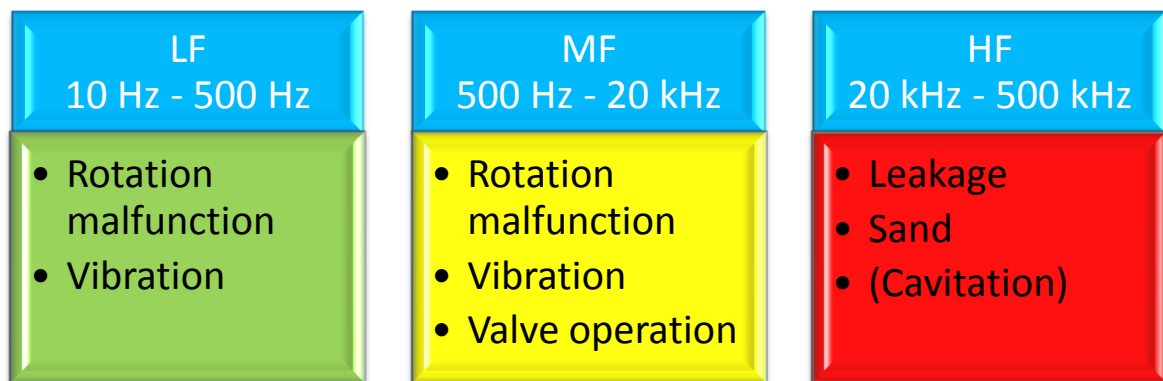

Figure 5.2: Areas of frequencies and the information they contain. LF = low frequency, MF = medium frequency and HF = high frequency. (Haugen & Naxys, 2004)

The typical sensor-array consists of several hydrophones (ALVD's for Ormen Lange has got 12 HF hydrophones and 5 MF hydrophones). The high number of sensors has the potential to produce waste amounts of data that need to be processed. Section 5.2 is an overview on the software and signal processing method used for this monitoring equipment. (Haugen & Naxys, 2004) It is common to apply a redundant system, and for the Ormen Lange ALVD's there are a primary and a secondary system. The primary system consists of both MF and HF hydrophones, and is capable of detecting both leak and vibrations. The secondary/redundant system consists of only HF hydrophones, and is only for leak detection. (FMC, Bjørge, & Statoil, 2010)

5.2 SOFTWARE AND SIGNAL PROCESSING

This section is a high level introduction to the user interface of the software and signal processing used in the ALVD delivered by Naxys AS. It is split into five parts; 1)

a general high level introduction to the system, 2) a description of possible communication lines, 3) a description of the method of analysis, 4) a presentation of the user interface, and 5) directionality and other challenges in signal processing. It should be noted that this description is valid for the full size complete ALVD, but not for the test unit. In the presentation of the test unit in chapter 10, deviations from the description here are presented.

5.2.1 GENEREAL

Topside (*note that topside is here used for both subsea-to-shore and conventional field developments, see definitions*) processing of large data amounts requires high speed transmission. If this is not possible, it should be arranged for local processing of signals. (Haugen & Naxys, 2004) This requirement is met by installing a subsea electronics unit in the ALVD, consisting of a container equipped with software, to process signals. The signals are compared to a baseline signature (*see definitions*). Deviations outside a preset threshold will generate an alarm in the user interface. The local signal processing allows for transmission on a low speed communication system, as the data load to be transmitted decreases. A traditional communication system will also allow for transmission of a smaller selection of raw data to the topside computer for analysis. If an alarm is presented, the last five minutes of raw data are automatically uploaded, along with trend frequency and correlation plots. This is done to make interpretation of the signals nature easier for the operator. (FMC, Bjørge, & Statoil, 2010) (Haugen & Naxys, 2004)

5.2.2 COMMUNICATION

As mentioned in section 5.1 it is common to have a redundant or secondary system. This is demonstrated in figure 5.3. On Ormen Lange ALVD's the primary system uses an IWIS (Intelligent Well Interface Standardization) connection. The secondary system uses a CanBus connection. (FMC, Bjørge, & Statoil, 2010)

An alternative to IWIS and CanBus is to use fiber optic cables. The use of fiber optic cable is becoming more common, and so the capacity to transmit real-time raw data at high speed improves. This implies that the need for subsea processing of the signals can be eliminated, and that as a result all electronics can be placed topsides. This is beneficial with regards to the use of standard modules, and the time and cost efficiency of maintenance and replacement of units. (Haugen & Naxys, 2004)

A second alternative is to use a combination of the two methods, where the signals are partially processed subsea, and then transmitted via fiber optic cable. This will allow for transmitting data with greater detail than what is currently done. This will also allow for transmitting raw data from a longer time period if this is desired.

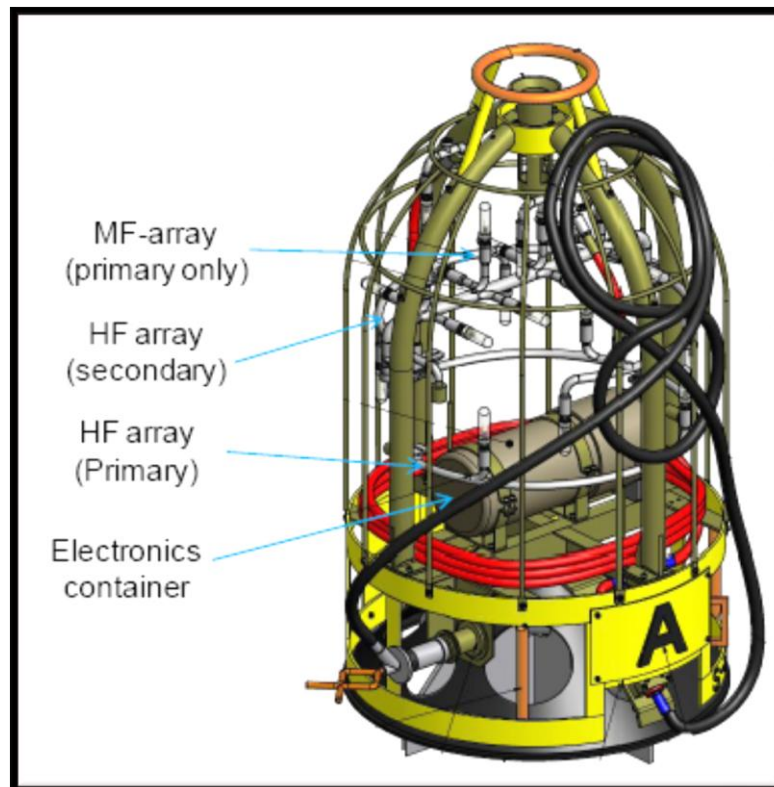

Figure 5.3: An Ormen Lange ALVD unit. The system is complete with IWIS and CanBus connection, and a redundant hydrophone array. (Bjørge and FMC for Statoil Petroleum AS, 2010)

5.2.3 METHOD OF ANALYSIS

The signals are analyzed through Fourier analysis. The mathematics of the Fourier analysis will not be discussed here, but an introduction to the principle will be presented. The Fourier transform is a tool used by scientists and engineers to make a problem more solvable. (Hoffman, 1997)

A complex signal is picked up (in the case of this project as a frequency spectrum), as a function of energy amplitude (A) and time (T). The spectrum is decomposed into individual frequencies that sum up to the initial function by the application of the Fourier transform. The frequencies are then presented as harmonics of the initial signal, plotted as energy amplitude (A) at a specific frequency (f). Ideally this will result in vertical poles. (Hoffman, 1997)

The analysis is done by computer, and because the computer is limited to work with discrete data only, it can only perform numerical Fourier transform with discrete samples. Solving discrete Fourier transforms is time consuming, and due to the complex nature of the acoustic signals that are picked up, it is impractical. An algorithm for solving the transforms much quicker than what can normally be achieved, called Fast Fourier Transform (FFT), is therefore utilized. The principle of solving problems through FFT is demonstrated in figure 5.4.

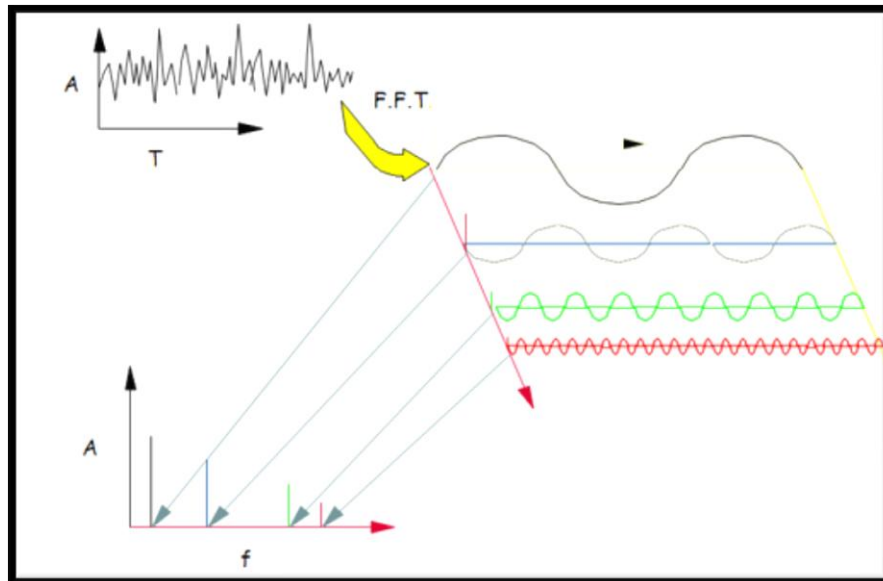

Figure 5.4: Example of the FFT principle. (Automatisering, 2011)

The Fourier analysis makes it possible to identify the acoustic signatures of the different equipment when it is run under normal conditions. These signatures are the baseline signatures, to which signals later on are compared to. Any wear or abnormal conditions should generate an alarm in the user interface.

5.2.4 THE USER INTERFACE

The user interface of the software is page based. This means that the user has the possibility to choose between several pages to different operations. The main pages represent leakage and vibration monitoring respectively. Each of the main pages has got two sub-pages, giving the operator the option between template and graph monitoring.

The graph monitoring option gives the possibility to look at trends over a time or at real time data. The operator can decide on how long a period he/she would like to look at. The template monitoring sub-page shows the monitored template. Figure 5.5 is a snap shot of this sub-page for an Ormen Lange ALVD. The template is divided in up to 15 sections. The sections are typically colored green during normal operation. In the case that an alarm is presented, the color of the sector affected is changed to red. (StatoilHydro - Hydro Oil & Energy Projects, 2008)

5.2.5 DIRECTIONALITY

When the ALVD is installed, the relative position of each hydrophone to the template is known. All the hydrophones pick up identical signals, but at different time, depending on the sound source location. By using the known locations and the time delay, the directionality to the sound source is found. When an alarm is presented, the section (see 5.2.4) affected is marked in red. In addition the user interface presents

the angle at which the source is found. If the exact template layout is known, this makes it possible to determine which piece of equipment that is affected.

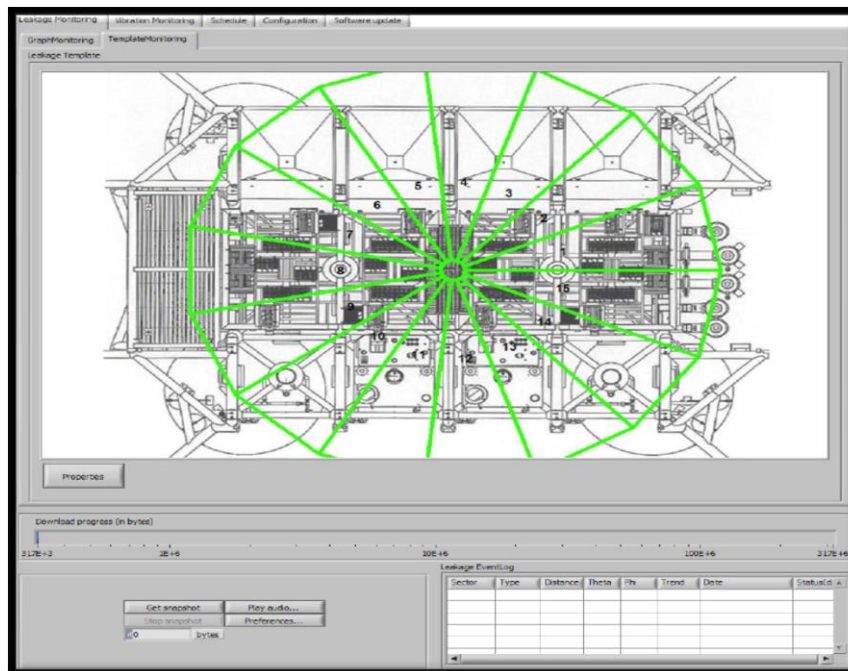

Figure 5.5: Snapshot of the template monitoring page in the user interface for an Ormen Lange ALVD. (StatoilHydro - Hydro Oil & Energy Projects, 2008)

5.3 PHYSICAL DESCRIPTION

This section offers a physical description of the average ALVD unit. Some of the ALVD's specifications are compiled in table 5.1.

Property	Description
Diameter	1 m
Height	~ 1.8 m
Weight	~270 kg
Material	Titanium
Number of hydrophones	17 (12 HF and 5 MF)
Communication types	IWIS and CanBus
ROV installable	Yes. Example: Fishtail connector for CanBus and IWIS (communication) connector.
Power requirement	10 – 30 W
Color	Yellow
Min. leak rate for detection	4 L/min

Table 5.1 Specifications of the ALVD unit for Ormen Lange. (Naxys AS, 2011)

Figure 5.3 shows a regular ALVD unit, as installed at Ormen Lange templates. In figure 5.6, an ALVD unit to be installed at Pazflor, an offshore oil development in Angola, is illustrated. The Pazflor ALVD is equipped with complementary UEP sensors, for combined acoustic and electromagnetic monitoring. Figure 5.7 is a picture from an FAT of an Ormen Lange ALVD at Naxys quay-side in Bergen. The picture gives an indication of the size of an ALVD.

As can be seen in the figures, the frame holding the sensors resembles a cage. The cage is made from titanium, a material selected due to its resistance towards corrosion, light weight and strength. The cage does not only facilitate the sensors and electronics, but also function as a protection structure. For additional protection, a protection cover can be utilized. The sensor arrays and electronics unit are placed inside the cage.

The electronics unit is pressure compensated. The desire to keep the unit as small as possible, the pressure compensation is done by a long hose with sufficient internal volume.

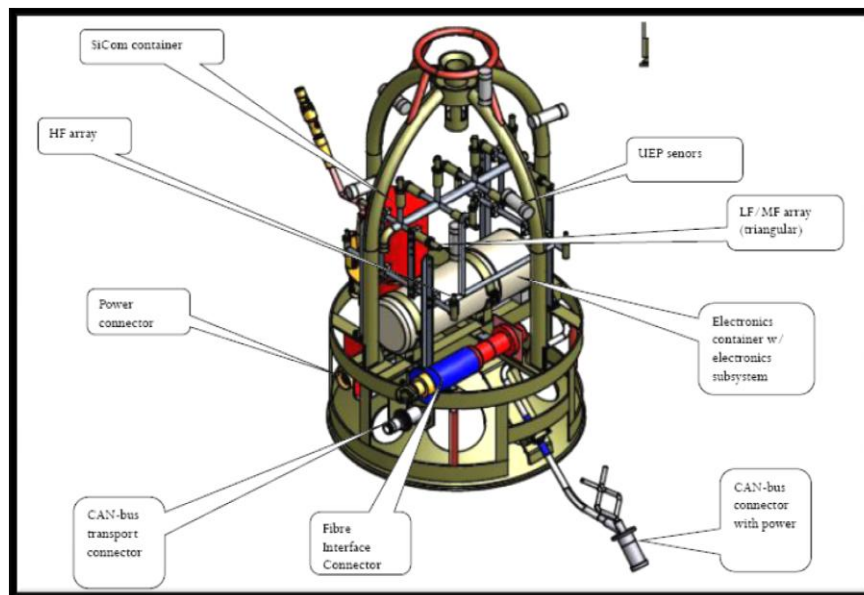

Figure 5.6: An ALVD unit with electromagnetic field sensors (UEP) as will be deployed at Pazflor, an offshore oil field in Angola. (Naxys, 2011)

5.4 TEST UNIT DESCRIPTION

Due to time constraints, a complete ALVD unit will not be built for this project. Instead, a test rig with the same function as the ALVD will be utilized. The equipment described in the main part of this chapter is the “permanent” subsea modules that are installed at Ormen Lange templates. This section introduces the test equipment’s main differences from the ALVD.



Figure 5.7: Picture from ALVD FAT at Naxys Quay side in Bergen. (Naxys, 2011) The picture gives an indication of the physical size of the ALVD unit. The picture gives an indication of the size of the ALVD unit. The bar hanging beneath the unit is a commissioning tool, consisting of a speaker and a hose. The commissioning tool is used to make artificial leak and vibration signatures.

The acoustic test rig will consist of an array of four MF hydrophones. In addition, five satellite HF hydrophones will be used. The satellite arrangement gives the opportunity to place the HF hydrophones close to different components of the OLSCP, which is beneficial for tuning.

The size and weight of the test rig will be less than a complete ALVD. The sensors will be connected by cables directly to a topside computer and data acquisition units, and so there is no need for pressure compensation or electronics unit in the pit. Chapter 10 offers a more detailed description of the test equipment and system layout.

5.5 ALVD LIMITATIONS

There are limitations to the ALVD technology. The main six limitations are (in un-prioritized order);

- 1) Challenges related to acoustic propagation properties as described in chapter 4,
- 2) The technology's novelty (towards extended functions).
- 3) Loss of data during transmission of raw data: as raw data is transmitted, new raw data will not be accumulated in the subsea system until all buffered data has been transmitted.
- 4) The systems sensitivity toward attenuated signals: As a threshold is set, signals with low energy amplitudes may be "missed".
- 5) Signal frequencies below the ambient background noise frequency in the sea,
- 6) Disturbances from ROV's: Experience from operation of ALVD's at Ormen Lange templates have shown that the presence of a ROV can be presented as an alarm for leak or excessive vibration. This is however an easy limitation to overcome, as any ROV operation is bound to be planned, thus operators can be informed of its presence in advance.

5.6 EXPERIENCES FROM SMALL SCALE PUMP FAULT DETECTION TESTS

ALVD systems are currently being used for pump monitoring at Tordis and Troll Pilot, but Naxys specifies that the systems are *not* delivered as condition monitoring units, as they are not currently qualified for this use. By testing the ALVD technology with the intention to extend its use as planned for this project, this qualification can potentially be achieved. The testing described in this thesis is based upon the expectation of ability to detect process characteristics and equipment function/condition through acoustic (and EM) signals. This expectation can be supported by results from previous off-site tests performed by Naxys. Two such tests are presented in this section.

The two tests were performed at Naxys quay-side. In the first test, a small pump was submerged in the sea, and the baseline signature for the healthy pump was recorded. After this, the pump was opened, and fine sand particles were introduced to the bearing. A new signature was recorded, and the curve presented together with the baseline signature in a diagram. Figure 5.8 shows this diagram. The curve for the damaged bearing is presented in red, the baseline signature in blue. As can be seen in the figure, there are differences between the two curves. The frequency range considered is found in the lower MF range described in section 5.1. (Naxys, 2011)

In the second test, the pump was run with corroded impellers. The corrosion led to an imbalance in the pump, which was clearly manifested in the signal curve. In figure 5.9, the curve from the corrosion is presented in red, and the baseline signature in blue. The curves presented are the first harmonics of the base frequencies, isolated during signal processing. The imbalance is indicated by the spike at approximately 40 Hz, which means that LF hydrophones are best suited to detect this failure mode. The curves are the courtesy of Naxys, and the tests have previously been described in Eivind Lyng Soldal's master thesis, University of Bergen, spring of 2009. (Naxys, 2011)

The results from the two tests give an indication that there is a real possibility of getting remote acoustic condition monitoring to yield conclusive results. The tests described here deviates from the planned testing in a number of ways. The first and most important is that in these tests the failure modes were known before testing were done. This will not be the case for testing with the Ormen Lange Subsea Compression Pilot (OLSCP).

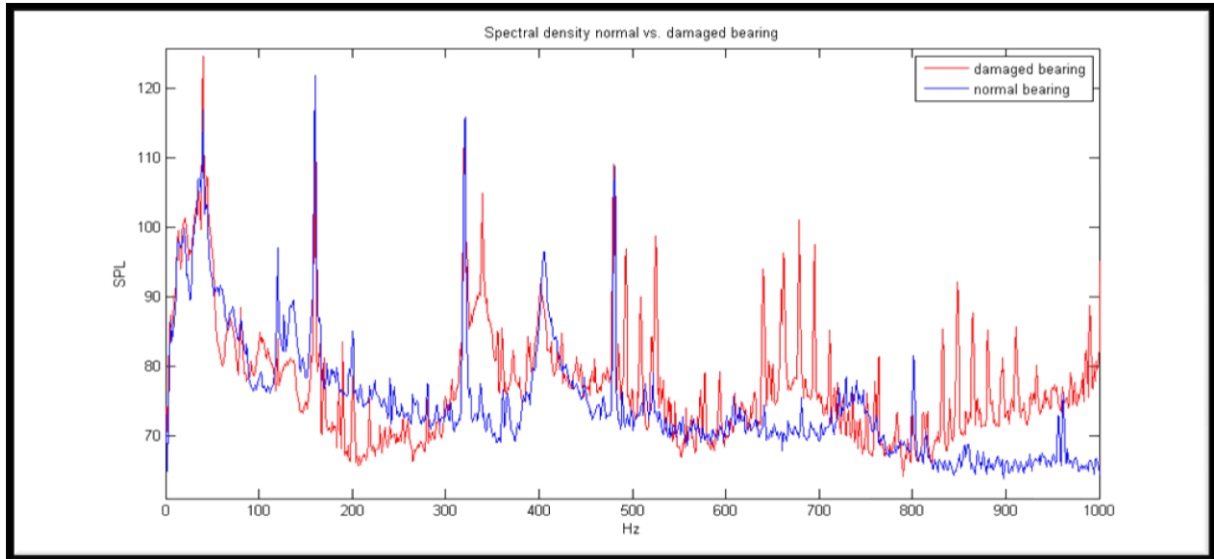

Figure 5.8: The signature of the pump with damaged bearing is presented in red, and compared to the blue baseline signature. (Naxys, 2011)

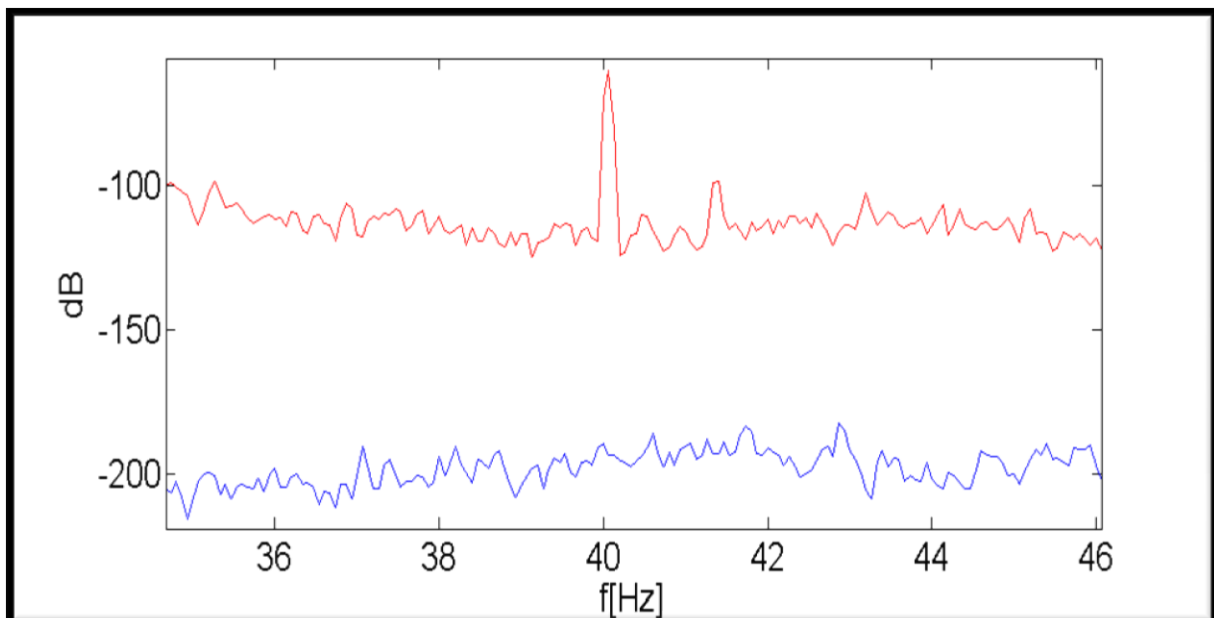

Figure 5.9: The red curve presents the curve from the pump run with corroded impellers, whereas the baseline signature is presented in blue. The spike at 40 Hz indicate impeller imbalance due to the corrosion. (Naxys, 2011)

For planned testing, the commissioning procedures and activities will be known, meaning that instead of fault detection, there will be the possibility to record baseline signatures for all normal operation. In addition, there will be the possibility to record signatures when the processing equipment is pushed outside of its normal operational range. The second difference is that these two tests were performed with a small single pump. In the planned testing, a much larger, complete subsea compression train (see chapter 7) will be monitored. This means that a more detailed signal filtering, based on frequencies, will have to be part of the processing. The third and last, significant difference is that the tests were performed in the sea at the quay-side. This setting offers fewer challenges with regards to echoes, and thus filtering of signals (as mentioned above) than in the test pit.

6. THE EMF SENSING SYSTEM

As a complement to the acoustic sensors, the monitoring unit will also be equipped with electromagnetic field sensors, to detect variations in the electromagnetic flux around the subsea equipment.

The sensors utilized will be of a type called UEP – Underwater Electric Potential. The electromagnetic sensing system consists of six electrodes, one pair in each x-, y- and z- direction. The individual sensor consists of approximately 800,000 carbon fibers in parallel connection. Carbon fibers are selected due to their short stabilization period in seawater, approximately 15 minutes before they are ready for use. The alternatives are Ag/AgCl and zinc electrodes, whose stabilization may take up to a week. Each of the carbon fibers are coated with a thin layer of varnish to keep them insulated from the seawater. In addition, the diameter of each fiber is reduced to a minimum to prevent biological growth. (Naxys, 2011)

As mentioned in chapter 3, the expected variations in the electric fields are small. Due to this, there is a risk that noise frequencies might influence or “contaminate” the measurements during transmission. This challenge is mitigated by installing a small pre-amplifier in the test pit. (Naxys AS (Frank Sæther), 2011)

The UEP sensors are sensitive, and therefore any use of a steel frame is avoided, as steel will conduct electricity and therefore possibly disturb the signals. Instead, a plastic frame, as shown in figure 6.1, will be used. (Naxys AS (Frank Sæther), 2011)



Figure 6.1: UEP sensor frame for installation in the test pit at Nyhamna. (Naxys AS (Frank Sæther), 2011)

7. ORMEN LANGE

The Ormen Lange field is located 120 km to the Northwest of the Norwegian coastline on the Norwegian Continental Shelf, in 850 – 1,000 m of water. The reservoir is found approximately 3,000 m below surface, and covers an area 40 km long, 8-10 km wide. Recoverable reserves are estimated to be about 397 billion Sm³ dry gas and 28.5 billion m³ of condensate. This estimation is based on the assumption that offshore compression will be utilized. (Bernt Bjerkreim, et al., 2009)

The field has been in production since 2007, with Shell as its operator. It is developed with subsea wells, with two 30" export multiphase pipelines tied back to the onshore processing facility at Nyhamna in Aukra. (Håkon Skofteland, ConverTeam, & GE Oil&Gas, 2009) Figure 7.1 is an illustration of the development concept.

The field's main drive mechanism is natural pressure depletion, and it is estimated that the offshore compression station will be needed by 2016 to maintain plateau production and increase the ultimate recovery. (Håkon Skofteland, ConverTeam, & GE Oil&Gas, 2009) (Bernt Bjerkreim, et al., 2009)

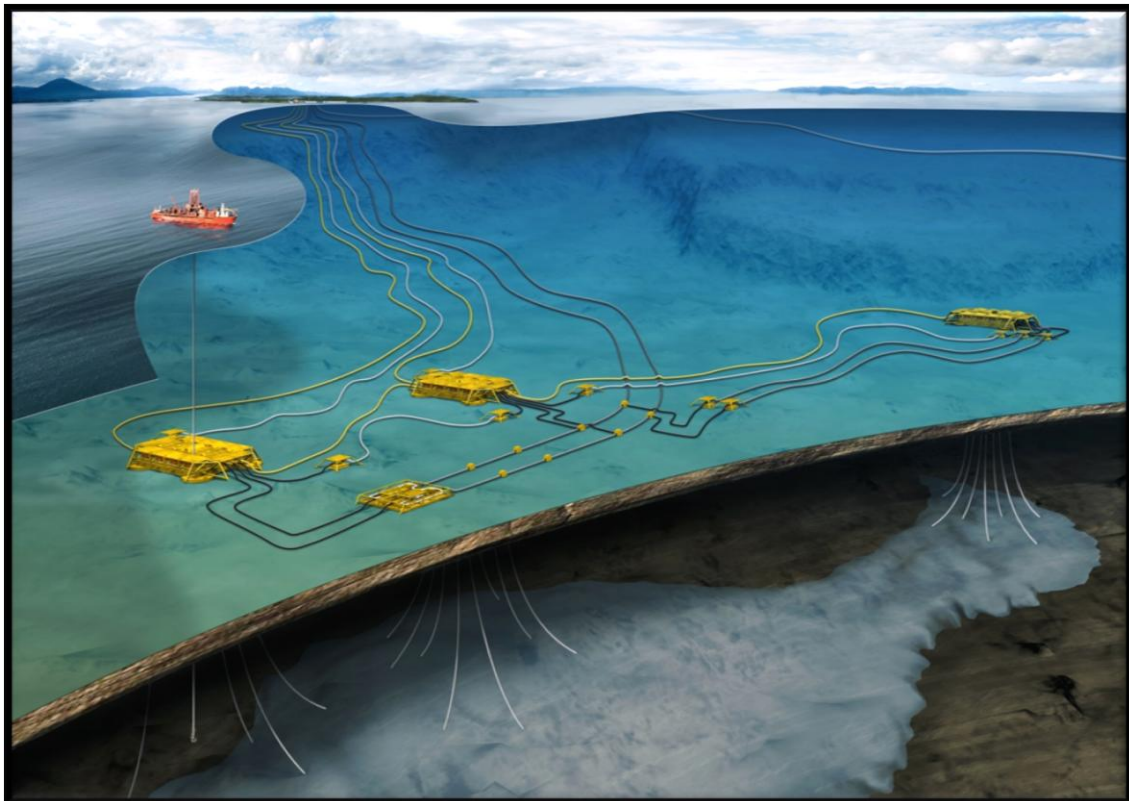

Figure 7.1: Overview of the Ormen Lange field: Subsea production templates and tie-back to onshore process facility. The red boat is the drill ship West Navigator. (ShellPictureDatabase, 2011)

Two solutions are being analyzed in parallel for the offshore compression, a subsea compression station and a floating compression station. It is expected that a decision on which concept that will be used is to be made in 2012. (Bernt Bjerkreim, et al., 2009) This thesis will only introduce the subsea alternative.

The future subsea compression station will consist of four equal compressor trains. Different layouts with regards to setup subsea (i.e. two pair, four single trains or one big station) and proximity to the different templates are being considered, and the final layout is yet to be determined. The third alternative, with one big station holding four trains, is the original design. The original design weighs about 6500 tons, measures 70 m long, 54 m wide and 14 m high, and will be qualified for operation at 900 m depth. (Håkon Skofteland, ConverTeam, & GE Oil&Gas, 2009)

The designers of the compression station needed to look at the possibility of having to do interventions, in addition to the challenges of transport and installation. The solution to these challenges is to let each compressor train consist of modules, each weighing less than 200 tons. The limit of 200 tons is set due to the fact that there are few intervention vessels that have the ability to handle higher weight than this. (Eriksson, 2010)

All subsea equipment must meet requirements of reliability and robustness, and the compression equipment will therefore be tested, large-scale, in an onshore water-filled pit, at Nyhamna. This test project is called “the Ormen Lange Subsea Compression Pilot Project” (OLSCPP).

7.1 THE SUBSEA COMPRESSION PILOT

As stated in the text above, the Ormen Lange Subsea Compression Pilot Project (OLSCPP) is a large-scale test project which will be carried out in a specially built test-pit at the onshore process facility at Nyhamna. The two main objectives of the project are to prove that subsea compression is feasible and to qualify the equipment for use in the Ormen Lange field. If these objectives cannot be met within the timeframe, the floater alternative will be selected.

The test-pit at Nyhamna measures 42x28x14m and is illustrated in figure 7.2. During operation the pit will be filled with seawater. In order to keep a near constant temperature in the pit, the pit is equipped with a system for continuous circulation of seawater. The pit temperature needs to be kept close to constant in order to simulate the operating conditions at the Ormen Lange field. The pilot’s electrical equipment (UPS’s especially) is designed for running in a cool environment, thus the seawater prevents overheating.

The pilot compressor train consists of different pieces of equipment. The main active process units may be identified as the separator with anti-surge cooler, the dry gas

compressor and the multiphase pump. All other equipment may be identified as associated equipment (UPS, VSD's for pump and compressor, circuit breaker, transformer etc). The main equipment is pointed out in figure 7.4, whereas the equipment size is illustrated in figure 7.3. The bus in the centre is at scale, and is added to illustrate the size of the pilot equipment. A single compressor train will (by today's design) weigh approximately 1100 tons, with each module weighing less than 200 tons. (Eriksson, 2010)

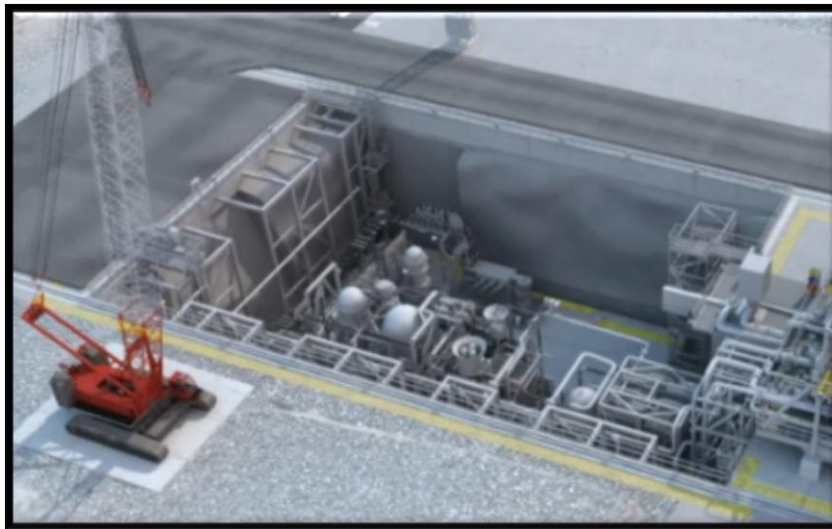

Figure 7.2: The test pit at Nyhamna. (Shell, 2010)

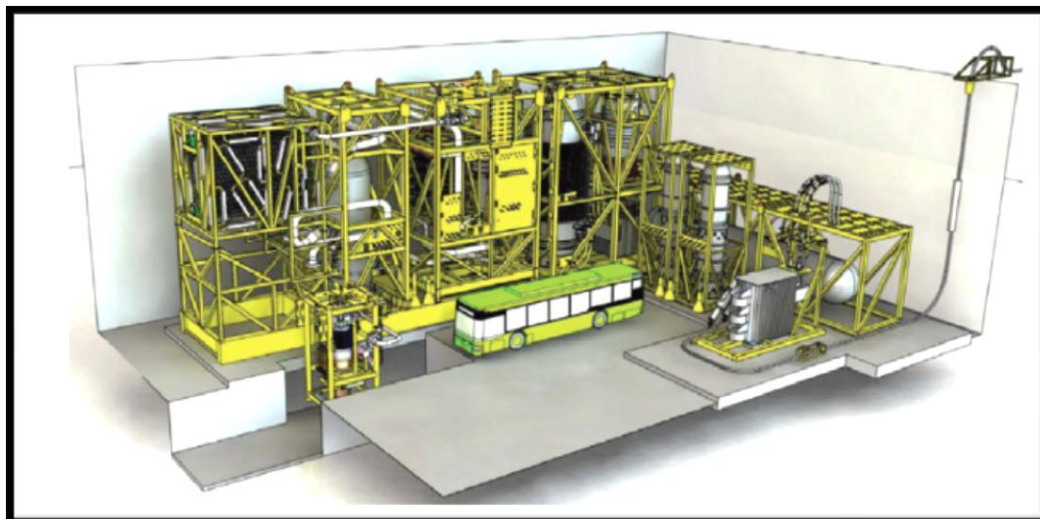

Figure 7.3: Layout of the OLSCPP in the test pit. Notice the bus, which is added to illustrate the size of the pilot equipment. (Eriksson, 2010)

In addition to the equipment sitting in the pit, there is a “topside” equipment module. Storage tanks for condensate, water, MEG and fines (small sand particles as produced from the Ormen Lange field) are all found on the top of this module. They are mixed with the gas to simulate the actual produced well stream from the field.

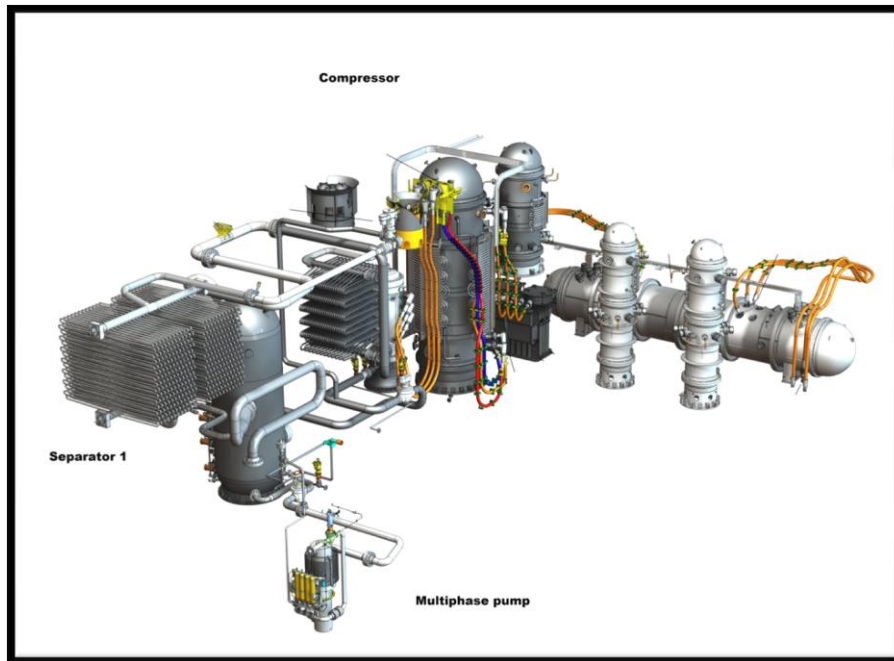

Figure 7.4: The pilot equipment without steel frame. (ShellPictureDatabase, 2011)

The gas, of sales-quality, will be delivered from the process facility. When all fluids (and fines) are mixed, they are led into the 2-phase separator. Thereafter dry gas will be delivered to the compressor, whereas liquid and fines are delivered to the multiphase pump. Liquids and gas will be boosted to the same pressure and remixed, before yet again being separated in the second separator “topsides”. When this is done, the loop repeats itself. Figure 7.5 is a simplified flow diagram, showing the loop in the pit.

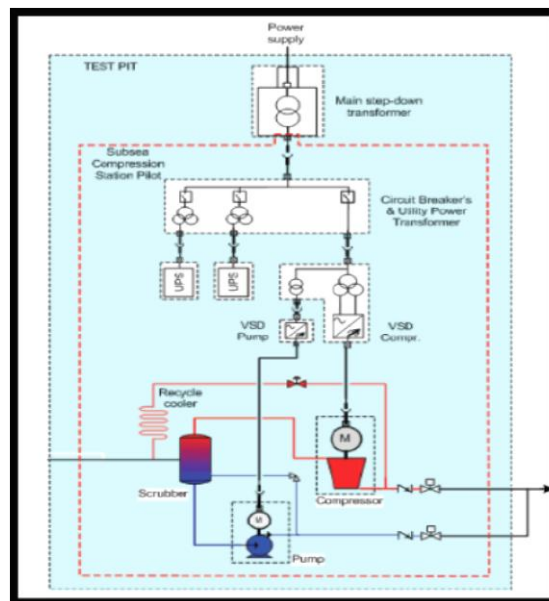

Figure 7.5: Ormen Lange Subsea Compression Pilot flow diagram and overview. (Eriksson, 2010)

7.2 PILOT MAIN ACTIVE PROCESS UNITS

This section describes the various pieces of active process equipment (the pump module, the compressor module and the separator module with anti-surge cooler), which will be located in the pit.

7.2.1 THE PUMP MODULE

The pump module is a 400 kW, vertically oriented multistage centrifugal pump, called LiquidBooster™, delivered by Aker Solutions. The pump is illustrated in figure 7.6. A variable speed drive (VSD) controls the pumps electric motor, and thus the pump. (StatoilHydro, Aker Solutions, 2009)

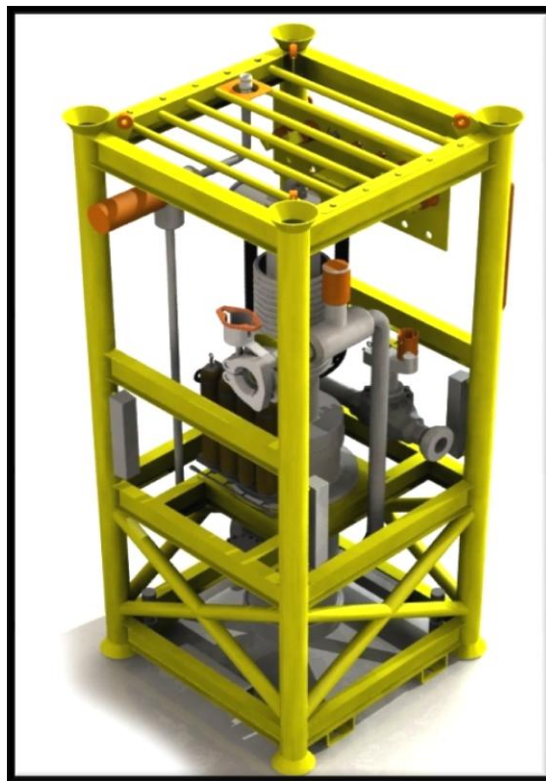

Figure 7.6: The pump module. (StatoilHydro (presentation by Bernt Bjerkreim), 2008)

The pump uses a barrier fluid for cooling, lubrication and leak mitigation. MEG is selected as barrier fluid. The reason for this selection is that MEG is already utilized for flow assurance at Ormen Lange, meaning that no dedicated barrier fluid supply is needed. In addition, there will be a small constant leak of barrier fluid into the

process fluid. MEG is already found in the process fluid, and so there will not be any additional flow assurance risks induced from this leak. (Aarvik, Halvorsen, & Bjerkreim, 2008) The barrier fluid's main purpose of cooling and lubrication is split in four:

1. Cool motor windings.
2. Cool and lubricate motor bearings.
3. Cool and lubricate pump bearing drive end bearing.
4. Cool and lubricate mechanical seal between coupling chamber and pump.

The barrier fluid system will, at all times, have an overpressure compared to the process fluid towards the coupling chamber/electrical motor, to avoid process fluid leaking into the pump. This overpressure will be 10 bar at all times, and is supported by a pressure and volume regulator. The pressure and volume regulator also accommodates volume changes resulting from variations in temperature and/or pressure. (StatoilHydro, Aker Solutions, 2009)

The pump will go through extensive tests with high sand rates to prove its efficiency and reliability during subsea operation. (Håkon Skofteland, ConverTeam, & GE Oil&Gas, 2009) The pump module is designed to handle liquid production for all operational conditions, including the ability to handle continuous sand production in the liquid flow from the separator. The lightest liquid (pure gas condensate) that will be pumped has a density of approximately 615 kg/m³, and will be produced during turn-down production at low rates. The heaviest liquid will be pumped during intervention, when MEG is used for hydrocarbon flushing. (Aarvik, Halvorsen, & Bjerkreim, 2008)

Table 7.1 presents selected parameters for the subsea pump. The specifications are gathered from the pump module detailed specification document developed by Statoil and Aker Solutions.

Description	Specification
Design water depth	900 m
Design life time	30 years
Design Pressure for pump, motor casings,/cooling coils	345 bara (internal pressure)
Pumped medium	Condensate, formation water and MEG
NPSHA	4 m – NPSHR at least 1 m less than NPSHA.
Rated motor voltage	2.5 kV
Solids concentration & size	25-150 ppm & < 40 µm
Rated shaft power	400 kW
Power frequency	7 – 67 Hz

Table 7.1: Selected design parameters (StatoilHydro, Aker Solutions, 2009).

For optimal NPSH (Net Positive Suction Head) the pump is vertically arranged, with the first impeller at the lowest location. The first stage consists of a double suction impeller, which reduces the NPSHR (NPSH Required). This reduces the NPSHR compared to a single suction impeller. This enables the pump to handle the low NPSHA (NPSH Available) resulting from a short and winding pump inlet.

7.2.2 THE COMPRESSOR MODULE

The compressor module includes a 12.5 MW motor-compressor designed for subsea operation. The compressor module is illustrated in figure 7.7. A selection of the compressor modules specifications are given in table 7.2.

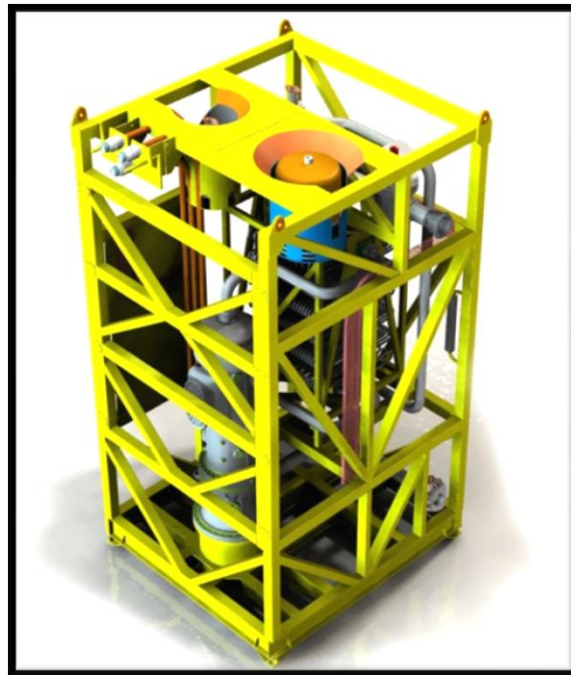

Figure 7.7: The compressor module. (StatoilHydro (presentation by Bernt Bjerkreim), 2008)

The incentive to keep the footprint of all equipment as small as possible dictated a vertical configuration for the compressor as well. This also brings along other advantages, such as the possibility of utilizing gravity to separate any liquid or fine that might enter the compressor, and that the motor can be placed above the compressor unit. This configuration prevents potential carry-over liquids from the separator to leak into the motor. The motor and compressor unit are separated by a barrier system, which ensures a clean operating environment for the electric motor.

The electric motor is equipped with low voltage magnetic bearings. (Håkon Skofteland, ConverTeam, & GE Oil&Gas, 2009) The magnetic bearings are results from an incentive to remove wearing parts. They are called Active Magnetic Bearings (AMB's), and are designed for a minimum of five emergency landings from full speed

and at any operational load without immediate need for maintenance. (Aarvik, Halvorsen, & Bjerkreim, 2008) There are three AMB's are installed in the compressor. The position of the rotor is controlled by controlling the current in the AMB's, based on information from position sensors. This is done by an electronic control system. The control system will also dictate the stiffness and damping of the shaft support. (Aker kværner, 2007)

Above the electric motor, an electric fan circulates process gas between the stator windings and the rotor for cooling. The gas is kept cool by an external cooler, consisting of a welded assembly of piping. The cooler is required to be able to cool the motor at both the Ormen Lange seabed and in the test pit at Nyhamna. (Aker kværner, 2007)

During commissioning and start-up with limited speed and power, the compressor motor is designed to run with nitrogen. During normal operation it will run with process gas. The cooling system requires special attention during commissioning and start-up, as nitrogen only has half the thermal capacity of methane at constant pressure. (Methane is the main component of the Ormen Lange gas, and will therefore dictate the thermal capacity of the process gas). (Aarvik, Halvorsen, & Bjerkreim, 2008) (Aker kværner, 2007)

Description	Specification
Design water depth	900 m
Design life time	30 years
Design pressure	205 bara (internal pressure)
Compressed medium	Gas
Rated rotational speed	10160 rpm
Rotational speed range	3048 rpm – 10668 rpm (30%-105%)
Rated power at motor shaft end	12.5 MW

Table 7.2: This is a selection of the compressor module's specifications. (Nuovo Pignone for AKER Kværner, 2009)

7.2.3 THE SEPARATOR MODULE

The 2-phase separator is designed as a vertical unit. This is, like for the compressor, resulting from the incentive to keep the footprint as small as practically possible. A selection of specifications is given in table 7.3, whereas figures 7.8 and 7.9 illustrate the separator.

Description	Specification
Design water depth	900 m
Design life time	30 years
Separated medium	Gas, liquid, solids (even though it is a 2-phase separator).
Height	7 m

Inner diameter	3 m
Level detection	Nucleonic system with conventional system for redundancy

Table 7.3: Selected design specifications for the subsea separator. (Aarvik, Halvorsen, & Bjerkreim, 2008)

The separator's liquid level is monitored by a nucleonic system. There is also a conventional level monitoring system for redundancy. The nucleonic level system is controlled by the pumps VSD.

Ormen Lange is expected to produce gas, condensate, water and fines. This means that slugs are expected to occur. As a result of these expectations, the separator has got the required volume to function as a slug catcher. (StaoilHydro, 2008) (Håkon Skofteland, ConverTeam, & GE Oil&Gas, 2009) The separator is also designed to separate liquids and solids from the gas, in order to avoid excessive erosion in the compressor. For the same reason it is also designed to limit carry-over of liquids to the compressor.

Avoiding clogging or accumulation of solids in the separator is important for limiting the carry-over. Clogs or solid accumulation could potentially (partially) block the liquid outlet, causing the liquid level in the separator to rise out of control. This again could lead to compressor failure. To avoid this, liquid is continuously recycled into the bottom of the separator. (Aarvik, Halvorsen, & Bjerkreim, 2008)

To keep the separator's retention time as short as possible, the inlet is optimized to maintain the natural separation in the piping.

7.2.4 THE ANTI-SURGE COOLER MODULE

During shutdown and start-up, the outlet gas from the compressor will be recycled. This is done in order to keep the compressor running in the event of an unforeseen shutdown, and to be able to perform shutdown and start-up in a safe manner. The recycled gas needs to be cooled before it re-enters the separator. This is done by the anti-surge cooler module. (Aarvik, Halvorsen, & Bjerkreim, 2008) The anti-surge cooler module is illustrated in figure 7.10.



Figure 7.8: The separator vessel during construction. (ShellPictureDatabase, 2011)

The anti-surge cooler module is designed for 9 MW heat dissipation to the surrounding seawater. This performance may degrade over time due to biological growth and mineral deposition. (Håkon Skofteland, ConverTeam, & GE Oil&Gas, 2009) The anti-surge cooler is also designed to handle full recycle flow at compressor maximum continuous speed (105 %). (StaoilHydro, 2008)

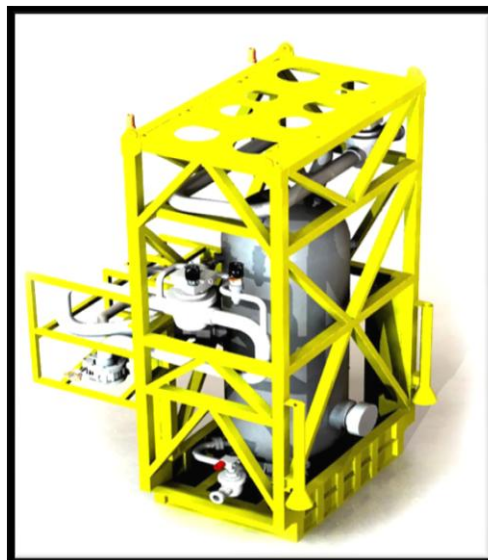

Figure 7.9: The separator module. (StatoilHydro (presentation by Bernt Bjerkreim), 2008)

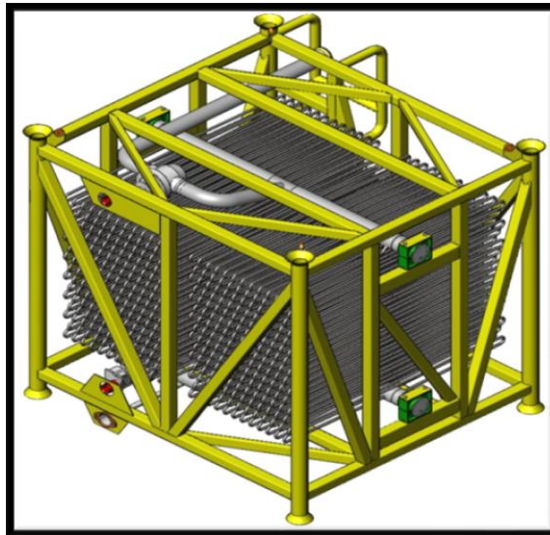

Figure 7.10: An illustration of the anti-surge cooler module. (StatoilHydro (presentation by Bernt Bjerkreim), 2008)

7.3 FAILURE MODES

In this section, a selection of failure modes for the active compression pilot equipment identified through Failure Modes Effect and Criticality Analysis (FMECA) will be given. The failure modes listed are the ones most likely to be detectable through acoustic monitoring. For most of the failure modes selected, there is no original detection method incorporated. Table 7.4-7.7 represents presents the failure modes for the different active process equipment. The tables contain five columns, of which two present the failure modes and cause. The next two will present original detection method incorporated into the compression pilot and comments related to acoustic detection. The fifth column offers a number for each failure mode. The failure modes relating to each component will be listed below the components name.

Most of the failure modes presented here, are in the FMECA's and FMEA described as low probability or medium/low probability failures. This means that the likelihood of the failures to occur is believed to be very low, although not completely unlikely. Most of the failures that are identified as potentially detectable by acoustic methods are leak and vibration related, as can be seen from the tables.

7.3.1 FAILURE MODES FOR THE SEPARATOR AND ANTI-SURGE COOLER

For the separator, most failure modes are related to leakages either into or out of the compression pilot system. Any leakages out of the system can be detected by acoustic monitoring, as proved from existing ALVD technology. Leakage of liquid into the gas outlet can potentially be identified as carry-over to the compressor. Partially clogged pipes and cavities are potentially detectable as high frequency acoustic energy, not

unlike a leak. This is due to turbulence resulting from a pressure drop over the partially clogged area.

No.	Failure mode	Cause	Original detection	Comment
Pressure vessel				
1.	Leakage, causing HC leakage to sea	Mechanical failure	None	Leakages can be detected by acoustic monitoring, although not before failure has occurred. (Proved for existing ALVD technology)
2.	Leakage, causing seawater in the compressor	Mechanical failure above cyclone	None	Carry-over to the compressor can potentially be detected as increased compressor load. If detected at an early stage, severe compressor damage may be avoided.
3.	Leakage, causing HC to sea/seawater in compressor	Over-pressure	Detectable through p. transmitter	As in 1. and 2.
4.	Nozzles, potentially causing loss of instruments	Hydrates, fouling, scale, foreign objects	Possible abnormal readings,	A partially plugged nozzle could potentially be detected with high frequency sensors – much like a leakage.
5.	Mechanical failure of separator skirt – causing leakage of HC to sea, and potential secondary system damages.	Shock and/or vibrations	None.	Assuming that the vibrations causing the failure are outside the normal frequency range for the separator, an alarm will be set off. Leakage to sea is detectable.
Interfaces				
6.	No sealing in gaskets and flanges, causing leakage	Improper installation, vibration	None	The cause is detectable, meaning that the failure mode can be avoided, assuming vibrations are outside the separator range. If leakage occurs, it is detectable.
Vane inlet				
7.	Vane cavity clogged	Solids, scale	None	A partially clogged cavity might be detectable by HF sensors (like a leak).
Demisting cyclones				
8.	Leakage from support plates, causing liquid in gas outlet	Shock, Vibration	None	Potentially detectable as in 2. Cause detectable.
9.	Gas leakage into the cyclone box causing liquid in gas outlet	Shock, vibration	None	As in 8.
10.	Leakage from drain nozzles	Shock, vibration	None	As in 8.

Table 7.4: Selected failure modes for the separator module suitable for acoustic detection. (Aker Kværner, 2008)

The failure modes that are potentially detectable by acoustic monitoring of the anti-surge cooler are all leak related. The potential leaks are reported as most likely to result from mechanical failure rather than shocks and vibrations. However, shocks and vibration may lead to mechanical failure and therefore leaks, thus vibration monitoring can still prove valuable as early warning of known causes for failure. As presented in chapter 5, the acoustic monitoring system provides vibration monitoring through the medium frequency hydrophones.

No.	Failure mode	Cause	Original detection	Comment
1.	Leakage from header causing seawater ingress/HC discharge – unable to run anti-surge	Mechanical failure	None	Acoustic leak detection proven.
2.	Leakage from cooler pipes, causing seawater ingress/HC discharge	Mechanical failure	None	As in 1.
3.	Leakage from inlet Pup piece causing seawater ingress/HC discharge	Mechanical failure	None	As in 1.
4.	Leakage from outlet Pup piece causing seawater ingress/HC discharge	Mechanical failure	None	As in 1.

Table 7.5: Selected failure modes for the anti-surge cooler suitable for acoustic detection. (Aker Kværner, 2008)

7.3.2 FAILURE MODES FOR THE PUMP MODULE

The FMECA for the pump module resulted in a long list of potential failure modes. The selection presented in table 7.6, only includes failure modes without an existing method of detection planned for the pilot. Some failures are not suitable for acoustic detection, but by electromagnetic detection. These are also presented in this table. The EM detectable failure modes are related to grounding failure in the electrical motor. Most failure modes detectable by acoustics are related to vibrations. For these failures the mechanism or cause will be detected, and not the failures themselves.

In the FMECA the pump is split into four main components, namely the centrifugal pump, the electrical motor, the pump module and the instrumentation and control unit. The four components are highlighted in green in table 7.6. Each item belonging to the individual component is highlighted in blue

	Failure mode	Cause	Original detection	Comment
Component: Subsea centrifugal pump				
No.	Pump rotor assembly			
1.	Excessive imbalance leading to vibrations or reduced lifetime of bearings.	Wear, foreign objects.	None	Can be detected by acoustic monitoring, as demonstrated in figure 5.8 in chapter 5.
	Pump shaft			
2.	Reduced cross section leading to fatigue of shaft.	Corrosion, erosion or wear.	None	Could potentially be detected by acoustic monitoring. If reduction of cross section is unevenly distributed, this will be presented as an imbalance.
	Pump impellers			
3.	Reduced performance	Broken vanes	None	Can be detected by medium/low frequency hydrophones, as variations in vibration pattern will occur. (This failure mode can also be detected by an accelerometer mounted to the pump, although such monitoring is not planned for.)

4.	Reduced performance	Low NPSHA	None	As in 3.
5.	Reduced performance that may lead to complete breakdown.	No or low liquid supply	None.	As in 3.
	Pump inner case, anti rotation knives			
6.	Reduced performance and loose parts	Loose knives	None	As in 3. Loose parts will alter the vibration patterns.
	Pump case wear Rings			
7.	Wear causing reduced performance	Vibrations	None	As in 3.
8.	Loss of fixation to inner casing	Foreign objects, wear	None	Foreign objects are detectable by acoustics, like other loose parts they will lead to variations in the vibration patterns.
	Pump outer barrel and end cover arrangement			
9.	Small leakage – leading to condensate leakage to sea	Static seal deformation	None	Any leakage that is within the detection range given in chapter 5 is detectable.
	Pump radial bearing			
10.	Mechanical damage at non-drive end causing vibrations and reduced lifetime of bearings.	Foreign objects, loss of cooling and loss of lubrication.	None	As in 8 and 3. In addition, variations in vibration patterns due to other causes than foreign objects are detectable.
11.	Mechanical damage at drive end causing vibrations and reduced lifetime of bearings.	Loss of cooling and loss of lubrication	None	As in 3.
	Pump thrust bearing			
12.	Mechanical damage causing vibrations and reduced lifetime of bearings.	Loss of cooling or lubrication	None	As in 3.
Component: Electrical motor				
	Motor rotor assembly			
13.	Excessive imbalance causing vibrations and reduced lifetime of bearings	Wear	None	As in 3.
	Motor stator windings			
14.	Grounding failure	Damaged insulation, bad insulation connection	None	Detectable by EM. The pump is designed to tolerate ground fault.
15.	Short circuit	Damaged insulation, bad insulation connection	None	Detectable by EM.
	Motor radial bearing			
16.	Mechanical damage at non-drive end causing vibrations and reduced lifetime of bearings	Loss of cooling or lubrication	None	As in 3.
17.	Mechanical damage at non-drive end causing vibrations and reduced lifetime of bearings	Loss of cooling or lubrication	None	As in 3.
Component: Pump module				
	Discharge check valve			

18.	Limited seat leakage of gas, potentially causing backflow	Damaged seat sealing surface, foreign objects or internal loose parts	None	As in 3, if caused by foreign object or internal loose parts. Gas leakage can potentially be detected.
	Discharge/Suction/Minimum flow insulation valves			
19.	Leakage to sea	External leakage	None	As in 9.
	Minimum flow valve			
20.	Leakage to sea	External leakage	None	As in 9.
	Clamp connection			
21.	Leakage to sea	Damaged seal surface, misalignment outside tolerance	None	As in 9.
Component: Instrumentation and control				
	Accumulators			
22.	Leakage of nitrogen to sea.	Bladder failure	None	As in 9.

Table 7.6: Selected failure modes suitable for acoustic and EM detection for the subsea pump module. (Aker Kværner, 2008)

7.3.3 FAILURE MODES FOR THE COMPRESSOR MODULE

For the compressor, the failure modes potentially suitable for acoustic detection are mostly related to corrosion and erosion. These two causes mechanical weaknesses and imbalances. Imbalances can in many cases be detected by acoustics, as have been demonstrated in chapter 5.6. Mechanical weakness is a failure mode which cannot be detected, but whose cause might be detectable. One of these causes is the presence of sea water in the compressor. Table 7.7 below offers an overview of the failure modes that have been identified as potentially suitable for acoustic detection.

No.	Failure mode	Cause	Current controls	Comment
Compressor impellers				
1.	Corrosion – causing loss of efficiency from reduced impeller thickness	Process gas composition	Vibration monitoring (accelerometers) and efficiency monitoring.	Potentially also detectable by remote acoustic monitoring. Remote system can potentially verify intrusive system.
2.	Corrosion – causing imbalance from reduced impeller thickness	Process gas composition	Vibration monitoring (accelerometers)	As in 1.
3.	Corrosion – causing mechanical weakness from reduced thickness	Sea water (maintenance problems)	None	Potentially detectable by remote acoustic monitoring.
4.	Corrosion – causing imbalance from reduced impeller thickness	Water due to condensation	Vibration monitoring (accelerometers)	As in 1.
5.	Corrosion- causing imbalance from reduced impeller thickness	Sea water (maintenance problems)	Vibration monitoring (accelerometers)	As in 1.
6.	Erosion – causing	Sand/liquids	None	As in 3. Acoustics are used for sand

	mechanical weakness from reduced impeller thickness	in the process gas		detection in other assets, and so sand in the compressor should be detectable.
7.	Erosion – causing loss of efficiency from reduced impeller thickness	Sand/liquids in the process gas	Performance monitoring system	As in 6.
8.	Erosion – causing imbalance from reduced impeller thickness	Sand/liquids in the process gas	Vibration monitoring (accelerometers)	As in 1.
Drainage				
9.	Plugging – causing fill up of liquid and damaging rotating equipments	Presence of foreign object in drain pipe	None	As in 3.
Rotor				
10.	Corrosion – causing imbalance from reduced thickness	Water due to condensation / seawater (maintenance problems)	Vibration monitoring (accelerometers)	As in 1.
11.	Erosion – causing imbalance from reduced thickness.	Sand/liquid ingestion	Vibration monitoring (accelerometers)	As in 1.
12.	Erosion – causing mechanical weakness from reduced thickness	Sand/liquid ingestion	None	It is likely that sand (and potentially liquid) ingestion can be detected.
Diaphragms/Diffuser/Flow path				
13.	Erosion - causing mechanical weakness from reduced thickness	Sand/liquid in the process gas	None	As in 6.
14.	Erosion – causing loss of efficiency and reduced thickness	Sand/liquid in the process gas	Performance monitoring	As in 6.
Bottom bearing				
15.	Erosion – causing damage of the can, potential consequent failure of the bearing	Sand/liquids in the process gas	Mechanical protection provided	As in 6. In addition, bearing failure can be detected, as shown in chapter 5.6.
16.	Corrosion- causing bearing failure.	Process gas composition, condensation	Canned bearings provided	Bearing failure can be detected as shown in chapter 5.6.
17.	Degradation of bearing due to contaminants – potentially leading to severe damage as result of vibrations during landing	Presence of contaminants	Mechanical protection provided	As in 16.
Intermediate seals				
18.	Increased clearance – causing excessive gas leakage flow to the motor	Vibration	Mechanical protection provided.	As in 1. Changes in vibration patterns are detectable.
Delivery and suction flanges				
19.	Gasket failure (delivery flange) – causing leak of process gas in the sea	Defect of material, incorrect assembly	1. Delivery gas pressure 2. Delivery gas pressure, pressurization control and commissioning	Any leak to the sea, above the limit set in table 5.1, can be detected.

20.	Gasket failure (suction flange) – causing slight ingestion of seawater in the process gas (demand of maintenance).	Defect of material, incorrect assembly	1. Low point drain system 2. Low point drain system, pressurization control and commissioning.	Leaks into the system can potentially be detected by a remote acoustic system, although this has not yet been attempted.
21.	Gasket failure (suction flange) – causing massive ingestion of sea water in the process gas (demand of maintenance).	Defect of material, incorrect assembly	1. None 2. Pressurization control and commissioning	As in 20. It is likely that the bigger the leak, the easier it is to detect.

Table 7.7: Compressor failure modes potentially suitable for acoustic detection. (GE O&G, 2006)

7.4 OTHER ISSUES OF INTEREST

Discussions with discipline engineers working at the OLSCPP identified a set of issues that the engineers recommended considered with regards to acoustic monitoring. The issues presented do not have a dedicated detection method. The issues are presented in table 7.8. The discussions took place in January 2011.

Equipment	Issue	Consequence	Comment
Pump: MEG cooling and barrier system.	During tests MEG gelling (due to heat) occurred.	A gelled cooling fluid will not cool the pump sufficiently, and possibly increase resistance to pump functions	Increased resistance should lead the pump to an increase in power consumption, and vibrations. Hence this should be detectable by acoustic and EM signature.
Pump: Short inlet, with many bends	Due to the compact design of the pump module, the inlet pipe has many bends. This means that laminar flow is hard to obtain and there is a possibility of getting cavitation in the pump.	Cavitation leads to extensive wear (pitting) on motor impellers, potentially causing imbalance.	Impeller wear can be detected by acoustic signature. Desire to observe cavitation before wear occurs, can possibly be detected by acoustic signature.
Compressor: Carry-over	Carry-over from separator to compressor	The compressor is designed as a dry-gas compressor. Liquid will reduce the performance, and wear/damage the compressor.	This is probably hard to detect by acoustics, but liquid in the compressor would probably lead to an increase in power consumption and possibly an increase in EMF.
Separator: Blocked pipe	Hydrates in flow recycle line.	Hydrate formation may lead to (partially) blockage of the pipe	Blockage of the pipe can probably be detected by acoustic signature (due to increase in fluid velocity and pressure drop, although it might not be possible by remote sensors.
Separator:	High retention volume	Pump wear	Do slugs of different densities

Slugs	and different densities of processed fluid may lead to slugs of different densities going into the pump		make different sound, if so, can an acoustic signature be established, and does this correlate to the EMF of the pump?
-------	---	--	--

Table 7.8 Issues identified for the OLSCPP equipment by discipline engineers.

It can be noted for these issues, as for the failure modes, that testing of the monitoring equipment in the pilot test pit, not necessarily answers the question if they can be acoustically monitored.

7.5 COMPRESSION PILOT INTEGRATED CONDITION MONITORING

Condition-based monitoring is the planned maintenance strategy for the future subsea compression station. Due to this, the OLSCP is equipped to facilitate for this during the pilot test as well. Since the OLSCP is a test object, there is an incentive to obtain as much data about the equipment and processes during testing as possible. (Eriksson, 2010)

Since the OLSCP is a prototype, the logging requirements will be much higher than for plants in normal operations. During two years of operation, it is expected that the monitoring system planned for the pilot will generate approximately 250 Tb of data, or approximately 1 million data per second. (Eriksson, 2010)

The data obtained during the pilot testing can be used for design verification and troubleshooting before the future compression station is manufactured. Amongst the data stored there are electric currents and voltages, structural vibrations, pressure and temperatures. All of the data is stored, and can be brought forward for analysis and visualization. (Eriksson, 2010) The structural vibrations are recorded using structurally mounted accelerometers at the steel frame. (Eriksson, 2010) All the sensors used are of known technology, thus the recordings can be used to verify (or contradict) recordings done by remote acoustic monitoring equipment.

7.6 PILOT PROJECT TIMELINE

This section presents some key milestones from the OLSCPP's schedule, with comments on what they mean for the remote monitoring project. Table 7.9 presents them as they looked in January 2011, when planning of the remote acoustic monitoring project began. The OLSCPP has been delayed over the spring of 2011, and so the new schedule (as it looks in the beginning of May 2011) is presented in table 7.10. The slippage in the OLSCPP schedule affects the remote monitoring project phases as described in section 10.5.

Date	Activity	Comment
April 30 th 2011	Pilot mechanically complete at Nyhamna.	Sensing equipment needs to be installed.
May 7 th 2011	Test Pit Water Filling	
May 13 th 2011	Seawater circulation test	Opportunity to calibrate to ambient noise in pit.
May 15 th 2011	Condensate pump initial testing	Opportunity to tune in the normal working signatures
May 22 nd 2011	Quick run on compressor on N2	Opportunity to calibrate
May 25 th 2011	1 st slug generation test	Opportunity to calibrate
May 28 th 2011	Draining of pit	Shut down at Nyhamna. Opportunity to adjust equipment.

Table 7.9: A selection of milestones with comments, from the OLSCPP schedule, as of January 2011.

Month	Activity	Comment
April 20 th -27 th 2011	Subsea condensate pump EFAT	Offsite monitoring test, in the pump test pit at Aker Solution Tranby.
August 15 th 2011	Pilot mechanical completion	Sensing equipment needs to be installed during July 2011.
September 1 st 2011	Water filling of pit	
September 15 th	Pilot commissioning	Opportunity to tune in the normal working signatures

Table 7.10: This table presents milestones from the Compression Pilot schedule, as of June 2011.

8. THE PROJECT

This chapter will give an overview of why the actual equipment was selected for testing, and how the work process for the project has been laid out. Some of the content has been mentioned earlier in the thesis.

8.1 CONCEPT SELECTION

The idea of testing remote leak and vibration technology with the aim of extending it into equipment monitoring was born at a brain storming session with members of Shells Subsea Hardware Team in November 2010. It is based on the perceived fact that while subsea equipments are being developed towards a higher level of complexity and utility, the monitoring systems have not received the same increasing attention. A consequence of subsea equipment's increased complexity is that the number of potential elements to go wrong also increases. If monitoring technology is not developed to meet the increasing complexity, a situation of increased intervention frequency, increased downtime and increased spare inventories might develop.

The decision of testing an acoustic and electromagnetic sensing system in conjunction with the OLSCPP was made after a feasibility check with the test and commissioning manager of the OLSCPP and Naxys, the equipment provider. The decision was supported by a number of elements, some of which are listed below.

1. The government's requirement to have a leak detection system in place subsea, and the potential for increased functionality.
2. Current business relationship between Norske Shell A/S and Naxys AS – the technology is known, but will be put to new use.
3. Naxys experience from pumps at subsea fields (i.e. Tordis and Troll Pilot) and from small scale tests have been promising with regards to the system's monitoring capability.
4. DNV's recognition that passive acoustic systems can potentially be used for valve and choke operation monitoring and for function monitoring of rotating equipment. (DNV, 2010)

The government requires the operators in the North Sea to have a subsea leak detection system in place. Increased functionality, where Naxys leak detection unit could function as a condition monitoring unit as well would give the opportunity to "kill two birds with one stone". It should however be noted that such a new monitoring system would first and foremost be a secondary system, as the industry is likely to have higher confidence in conventional (non-remote and intrusive) sensing systems, which will be used as primary systems, at least for developments in the near future. This opens for the possibility to use a remote system for verification of the primary system, which in turn may prevent unnecessary equipment retrieval as result of a primary sensor failure.

Shell is currently using Naxys ALVD system at the Ormen Lange templates, for leak and vibration monitoring, and is through that familiar with the monitoring equipment. It is recognized that all equipment and processes have got an acoustic and electromagnetic baseline signature when operating in normal condition, and that by comparing this to the signatures recorded at any given time, the equipments condition can be determine. This is in compliance with the two criteria for successful condition monitoring as described by B.K.N Rao (see 2.1).

Naxys experience with pump monitoring at Tordis IOR and Troll Pilot, and small scale tests (see 5.6) does not qualify their ALVD system for condition monitoring of pumps. However, it raises the expectation that it is possible, and even plausible to believe, that the system can be used for condition monitoring. From Tordis IOR, Naxys have experienced that electromagnetic sensing can be used to assist in acoustic signal processing, for better determination of directionality. Electromagnetic sensors can also detect ground or short-circuit/open-circuit related failures.

The selection of test object is described in the introduction to this thesis (chapter 1). A summary of the selection criteria for the OLSCPP as test object is presented here;

1. The OLSCPP will be commissioned and tested in a shallow test pit on land. This eliminates the need to deploy an expensive vessel to install the monitoring equipment. It also eliminates the need for expensive communication lines from the sensors to the topside computer. The local network at Nyhamna offers the possibility to remotely operate the monitoring equipment, reducing travelling time and costs.
2. The OLSCPP offers complexity and size, which will enable testing the equipments capability to monitor several pieces of equipment at one time, and establish whether there are any limitations to this.
3. The commissioning of the OLSCPP will generate a detailed log, to which the recorded EM and acoustic signatures can be correlated. By comparing timestamps improved understanding of what each change in signature means can be obtained.
4. The commissioning of the OLSCPP will run the different equipment through its entire operational range, allowing for improved tuning of baseline signatures.

In addition to the criteria listed above, the concept selection was supported by an investigation into which other remote subsea monitoring systems on the market. As it turned out, no remote systems were found to be available. Current sensors are commonly non-remote and/or intrusive. Examples of such are the ClampOn technology for corrosion/erosion detection and Acoustic Emission (AE) sensors for crack detection, as well as temperature and pressure sensors. The conventional sensors are typically limited to monitoring for one specific condition, and not the overall equipment condition or process function. This means that the more it is desired to monitor for, the more sensors are needed. As stated above it is perceived

that the acoustic/EM system can potentially offer a more complete monitoring system, which will reduce the necessary number of sensors.

8.2 PROJECT PLANNING PROCESS

This section gives a high level overview to how the project planning process has been. Figure 8.1 presents this overview, showing some of the steps that have been taken during the planning. The project planning has been carried out in cooperation with Naxys and engineers working on the Compression Pilot. Aker Solution is a contractor working close to the “pilot team” and has also been involved in the planning.

The monitoring project is being planned during the spring of 2011. The planning started in February, during which month the project scope was developed, and objectives for the project were set. The function of the monitoring equipment was investigated, through documents on functional design, user manuals and FAT/EFAT procedures. A demonstration of the equipment function was given during FAT of an Ormen Lange ALVD. During the FAT leaks and vibrations were simulated, and detected by the ALVD. Understanding the equipments function and limitations has proven to be valuable when setting the test success criteria’s for the onsite testing at Nyhamna.

During March, one of the steps was to understand the Compression Pilot. This understanding was achieved through reading functional specification documents, and conversations with discipline engineers from the Pilot team. In addition, site visits were made to Aker Solution in Egersund where the Compression Pilot was being stored and worked on. A visit to the test site at Nyhamna was also made.

Initially, the monitoring project was intended to be a small study, running in parallel with the OLSCPP commissioning activities. However, regulations and requirements at Nyhamna – for both work management and equipment – created a need for a closer interface with the OLSCPP. At this point, the monitoring *study* turned into a monitoring *project*. This close interface meant that a Plant Change Request (PCR) needed to be made for the test site, and that a Decision Review Board (DRB) needed to approve the installation and the budget. In addition, arrangements had to be made in order to get the equipment into the “as-built” drawings for the test site. The DRB approved the installation and testing after being presented with a business case for the project, convincing it of the potential benefits from the testing.

The equipment installation procedures were prepared in April as part of the Scope of Work document. The Scope of Work document also states details on who will be performing the work, equipment specifications and system layout. This document was of importance since Aker Solutions used it to produce job cards for the installation in May. A Project Execution Plan (PEP) was also made. The PEP gives details on lines of the communication, change management, HSE and Q and roles and

responsibilities. It also gives instructions on the test procedure. In the end of April and beginning of May the Compression Pilot's subsea pump was to undergo its EFAT. This was an opportunity to do some pre-testing of the monitoring equipment. Arrangements for this were made, and the testing is described in chapter 9.

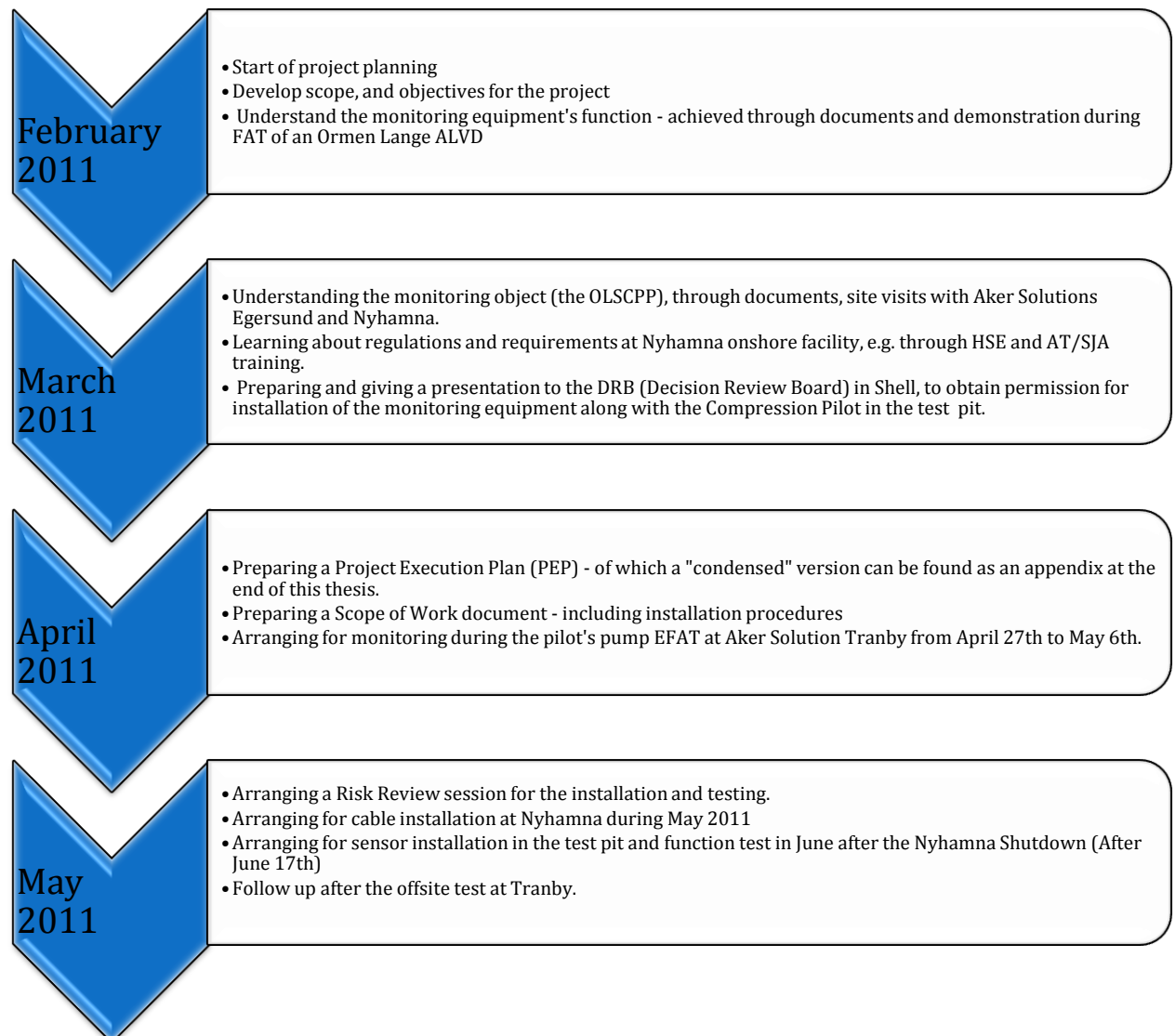

Figure 8.1: The project planning process during the spring of 2011.

In the beginning of May, project risks were evaluated, and a risk review will be held in June, after the shutdown at Nyhamna. In order to perform any work at Nyhamna work permits and safe job analysis must be obtained and gone through (see chapter 10). The risk review ensures that all safety aspects are considered and taken care of, and is by that important for the quality assurance of the project. During May, cables from the test pit to the instrumentation cabin will be installed. The installation is executed upon job cards prepared by Aker. Aker will also prepare job cards for the

installation of the remaining part of the equipment, which will be installed during the summer, after the Nyhamna shutdown in June has ended.

8.3 PROJECT BUDGET

As with everything else, projects do not come for free. The project's cost is split between Norske Shell A/S and Naxys AS. Figures for the project budget will not be presented here, as this is Shell proprietary information.

The budget for the project is relatively low. The main contributors to the budget are work hours and equipment costs.

The first phase budget includes all equipment and planning costs, and therefore the cost of a second phase will be significantly lower than the costs of the first phase. Even so, the dividing of the testing into two phases with separate budgets reduces the cost of a potential failure to meet any of the success criteria.

8.4 PROJECT TIMELINE

Because the monitoring project is subjected to changes in the OLSCPP's timeline (see section 7.6), a detailed timeline for the overall project cannot be given. However, important milestones in the planning and testing project currently known (as of June 2011) is presented in figure 8.2.

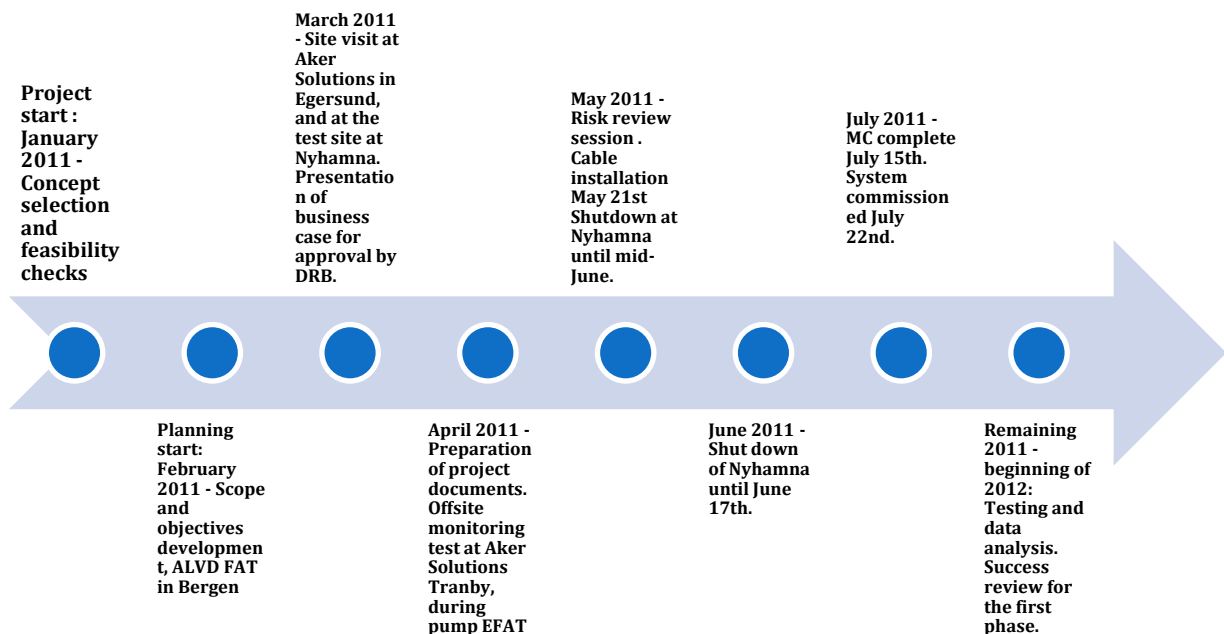

Figure 8.2: The project timeline as of May 2011.

The installation job cards are prepared in June and will determine a more detailed installation schedule. However, it is given from the monitoring equipment's simplicity that the installation is fairly simple to execute, and that it should not require a whole

lot of work hours. So far, it is planned to use no more than maximum 24 work hours. This is subject to changes as the OLSCP activities may make it impossible to install everything in two “runs” (i.e. land cables as one run, and the remaining equipment in one). Due to the high probability for changes, the detailed schedule will not be reported here. It can be noted in figure 8.2 that the system is to be commissioned at July 22nd, and that all mechanical completion will be on July 15th.

9. AN OFFSITE PUMP MONITORING TEST AT TRANBY

Due to time and cost constraints, the only offsite testing performed before equipment installation at Nyhamna was performed during the Compression Pilot's pump EFAT (Extended Factory Acceptance Test) at Aker Solutions at Tranby, Lier. Figure 9.1 shows the pump module in the test pit, without the pump, and gives an indication of the test setup. Naxys has previously performed a similar type of testing at the same facilities, when applying acoustic and electric monitoring of a water injection pump (for Tyrihans).

The equipment used during monitoring of the pump EFAT is the same as will be used for monitoring of the Compression Pilot. Descriptions of the test unit are found in section 5.4 and in chapter 10.

During the pump EFAT the pump will be submerged into a test pit, and run through a 100 hour full load test, also including leak-tests and barrier fluid consumption of the pump. As an example of what is being done through the 100 hour test is that the pump is taken from minimum to maximum flow at given RPM "steps", i.e. 1000 and 1800 RPM. The EFAT log will be used for correlation of the recorded data from the monitoring equipment.

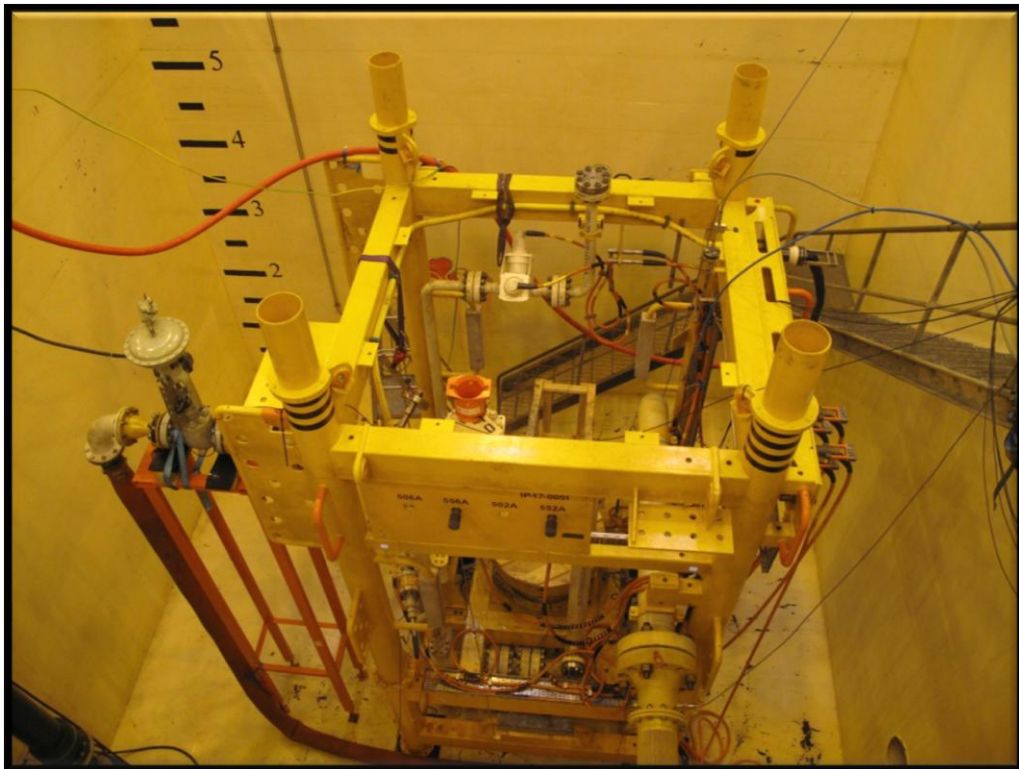

Figure 9.1: Compression Pilot condensate pump module without pump in test pit at Aker Solutions facilities in Tranby, Lier for 100 hour full load test.

The intention was to present some of the results from the offsite monitoring test at Tranby, to further demonstrate the perceived capability of the monitoring system. However, upon the delivery of the thesis, the data was still not analyzed.

10. TESTING AT NYHAMNA

The work put in to the Project Execution Plan (PEP) is significant, but as it is viewed as a proprietary document it cannot be published as a part of this thesis. As a substitute for the actual document, this chapter will describe the testing to be performed at Nyhamna from an organizational point of view. Some of the information belonging to the PEP is also to be found in chapter 8. Issues like HSE, quality assurance, risks, system layout and test execution are described here. Management of change, budget *details*, and communication lines containing names and phone numbers to involved parties are also part of the document, but will not be reproduced.

In addition to this chapter and chapter 8, a “condensed” version of the PEP is added as an appendix at the end of the thesis.

10.1 HSE AT NYHAMNA

The onshore process facility at Nyhamna processes the entire Ormen Lange well stream, before exporting gas to Great Britain via pipelines. There is a lot of activity and processes going on at the facility at all times, thus all personnel must undergo HSE training specific for the area in order to enter. The HSE training consists of two courses, one on the HSE regulations at Nyhamna, and one on work permits and safe job analysis (AT/SJA) requirements.

The HSE regulations at Nyhamna require all personnel entering the site to wear a full PPE-kit (Personal Protective Equipment kit). This kit consists of non-flammable work clothes, hard-hat, safety goggles, ear-cover, gloves and steel-toe-shoes. In addition all personnel on site are to carry a radio, to ensure that they will hear any warnings or messages in the case of an incident. The HSE rules also require proper safety gear to be used when working at heights above 1.8 m.

At a gas processing plant, there is always a risk of escaped gases. This requires that all equipment brought into the area to be EX-certified. Due to this, it is prohibited to bring cameras, cell-phones, laptops etc into the area. The monitoring sensors and equipment to be submerged in the pit does not need to be EX-certified, as the water will act as a seal towards any leaked gas. The test computer and data acquisition units will be placed in an instrumentation cabin (S120). This cabin is classified as EX-proofing for all equipment placed inside. Any welding or “warm work” required during assembly of the compression pilot or maintenance elsewhere at the processing plant needs to be performed in an over-pressured habitat. The over-pressure prevents any leaked gas from entering the warm work area, thus the explosion risk is mitigated. In addition to over-pressure, gas measurements are constantly performed to ensure that it is safe to work in the area.

Transportation of personnel at the processing facility is done by walking or bicycling. In addition there is a shuttle bus, transporting workers from the main office building to the work site. If driving is necessary, a special permit for entering the area with a car has to be obtained. Even with such a permit, transportation can only be done at the outer roads, at safe distance from the plants main processing equipment. If transportation near or to this equipment is necessary, the car has to be equipped with a gas sensor and an automatic engine kill-switch.

The test pit is classified as a “closed area”. This means that due to limited escape routes in the case of an incident, a maximum of twenty persons can be present in the test pit at any given time. A safety officer at the site is responsible for knowing how many persons are in the pit at all times. At the Nyhamna test site the safety officer uses a set of cards hanging on to walls, to keep track of the workers. The set contains only twenty cards. When a worker enters the pit, the safety officer moves a card from one wall to another. Then, when the worker leaves the pit, the card is moved back.

No work will be performed without a work permit, a safe job analysis and a proper job card describing the procedures/actions. All work is to be performed by staff holding the right skill for the task at hand.

In addition to site-specific HSE requirements at Nyhamna, the general HSE rules and guidelines within Shell have to be met.

10.2 QUALITY ASSURANCE

Quality needs to be considered when executing a project. Quality can have various definitions, but is here defined as a combination of things;

1. The project is delivered at specifications
2. The project is meeting the requirements and regulations
3. The project is value adding

To ensure that the project is delivered at specifications and that all requirements and regulations are met, competence from different parts of Shell is gathered. What this means is that i.e. cables are approved by a Technical Authority before procurement, and that installation procedures are reviewed and evaluated for safety. In addition all documents produced and information gathered through the project is marked with the OLSCPP project number and stored at the same location, to ensure that it is easy to control at a later time should this be necessary.

The most difficult issue of these three is to evaluate the value of the project. If considering three potential outcomes (beyond the criteria for success), the project can be either;

1. 100 % successful, resulting in a new monitoring tool with proven capability of failure mode identification, early fault detection and performance monitoring.
2. 100 % unsuccessful, resulting that no type of extended function of the ALVD is found to be realistic. This alternative will still increase knowledge on the existing ALVD function that can be used for improvement.
3. Something in between the two, this can result in any extended function such as e.g. early fault detection, verification of primary data, recognition of process characteristics or detection of gradual performance loss.

It is clear that both result 1 and 3 in this list will add value, as they will result in extended function potentially capable of major savings in terms of intervention cost, time and safety improvement. It is more difficult to argue this for result 2. However, the improved knowledge of the existing ALVD function can be used to optimize sensitivity and level of detail through improvement of processing algorithms. This again can be used for improved directionality and detection of smaller leakages than what the system is currently capable of.

10.3 REQUIREMENTS AND REGULATIONS

As stated above, meeting requirements and regulations is important for the quality assurance of the project. Important requirements are summed up in table 10.1 below, along with comments on exceptions and alternative solutions where suitable. The regulations are the total “package” of official regulations (i.e. concerning transport/shipping of equipment) and site specific regulations concerning project execution and access to the area. Table 10.1 does not include issues related to HSE and AT/SJA training, section 10.1 describes these, nor does it include official regulations/legislation with regards to transport/shipping.

Requirement	Comment
All equipment needs to be EX – certified.	Exception for submerged equipment and equipment placed in EX-proof cabins, conditional upon the equipment being shut off when dry/cabin is open.
Land cable must be halogen free, self-extinguishing and mud/oil resistant.	No exceptions.
Land cable needs to follow cable trenches from the test pit to the cabin S120	No exceptions.
Subsea cable needs to be secured in the pit	Subsea cable will follow cable gates coming into the pit. At the pit floor the cable will be fixed by weights.
Equipment needs to be secured	Concrete weights will be added to the equipment

in the pit.	structures to keep them in place.
Work on the compression pilot is prioritized	No exceptions.
Instrumentation cabin (S120) is to be shut when equipment is powered, to maintain EX integrity.	Equipment is controlled and data retrieved remotely via network connection. As an alternative, data can also be stored on an external hard disk and transported by e.g. mail from Nyhamna to Naxys in Bergen.

Table 10.1: Requirements and exceptions for the project

10.4 RISKS

The risks for the project are low. This statement is based on a risk review, considering the monitoring equipment and its impact on the monitoring object, HSE, quality and costs. Below follows a selection of risks:

1. Emissions:

If the hydrophones are damaged (i.e. cut during installation), a small quantity of oil (max. 2 dl) can leak into the test pit. This is considered a low risk, as the PPE required for presence at the test pit will be sufficient to protect personnel, and as the oil leak is sufficiently small to be easily cleaned up in the dry pit. No other emissions can result from the monitoring equipment.

The test site location does not require vessel mobilization, which reduces shipping and installation related emissions.

2. Lifting:

Small and lightweight monitoring equipment reduces the required number of lifts to a minimum, and no heavy lifting is required. To reduce the number of lifts even further, it is suggested that the monitoring equipment is lifted into the pit in a work basket.

3. No interface:

The monitoring will be fixated by weights in the pit, to avoid the circulating seawater current to disturb the Compression Pilot. In addition, there is no other interface with the Compression Pilot, meaning that it will not interfere with it in any way.

4. Limited time for installation (see section 10.8):

If equipment is not ready in time, the opportunity to install is lost. This is one of the larger risks.

5. Stable network (see section 10.8):

This is also one of the larger risks, as valuable data can be lost if the network connection is lost.

Beyond the risks listed here, all of the limitations listed in chapter 11 can be stated to be risks of the project. Even so, the risks are considered to be low.

10.5 SYSTEM LAYOUT AND INSTALLATION

The system layout is shown in figure 10.1. The drawing shows the approximate location of the sensing equipment in the test pit. The squared “box” labeled S120 illustrates the EX-certified instrumentation cabin, in which two data acquisition units and a computer will be installed. The power supply in S120 will be four 230 V sockets, and network connection will also be provided.

From S120 three land cables (type DRAKA RFOU(i) 250 V) will be routed through cable trenches to the pit. The cables have a length of 90 m each, and meet the requirements given in table 10.1. At the edge of the pit, the cables will be terminated in junction boxes (type EXE GFG745), in which they will be spliced to the three subsea cables (type Macartney 4622). Like the land cables, the subsea cables are each 90 m long.

One of the subsea cables will be connected to five high frequency hydrophone satellites, by a cable mould type connection. The other two subsea cables have will be terminated to the medium frequency array and the UEP sensor array by SubConn connectors. The subsea cables will follow existing cable trays coming into the pit, and will be secured by weights in the pit.

The satellite hydrophones will be mounted on single stands, with approximate heights of 1 m. In the medium frequency array, the hydrophones will be mounted in a small steel frame, measuring approximately 1 m x 0.3 m x 0.5 m. The UEP sensor frame is made from plastic. This is to ensure that the frame does not conduct any electric signals to the sensors (see chapter 6). The monitoring equipment will be fixed in place by concrete bases. The fixation of cables and equipment is necessary due to the circulation of seawater in the test pit.

Figure 10.1 shows the proposed system layout for the monitoring equipment. The MF array and the UEP sensors are placed approximately in the centre of the test pit. This is to minimize the effects of acoustic echoes, and to ensure as equal proximity to each component in the OLSCP as possible. The HF satellites will be placed close to the different components. This is partly due to the fact that they will be listening for leaks, cavitation, sand and liquid presence. This will also help optimizing the recording of baseline signatures.

As can be seen in the figure, the UEP sensor array will be connected to a pre-amplifier canister. This will amplify the variations in the electric field detected, and transmit to the data acquisition boxes in S120, which in turn will feed the signals to the computer. A simplified block diagram showing the basic setup is presented in figure 10.2

As stated earlier, Aker will produce the job cards for equipment installation on contract from Shell. The installation will be executed upon the job cards by Aker or other contractors familiar with the test site. Naxys personnel will supervise the installation, as they are more familiar with the monitoring equipment than the other contractors.

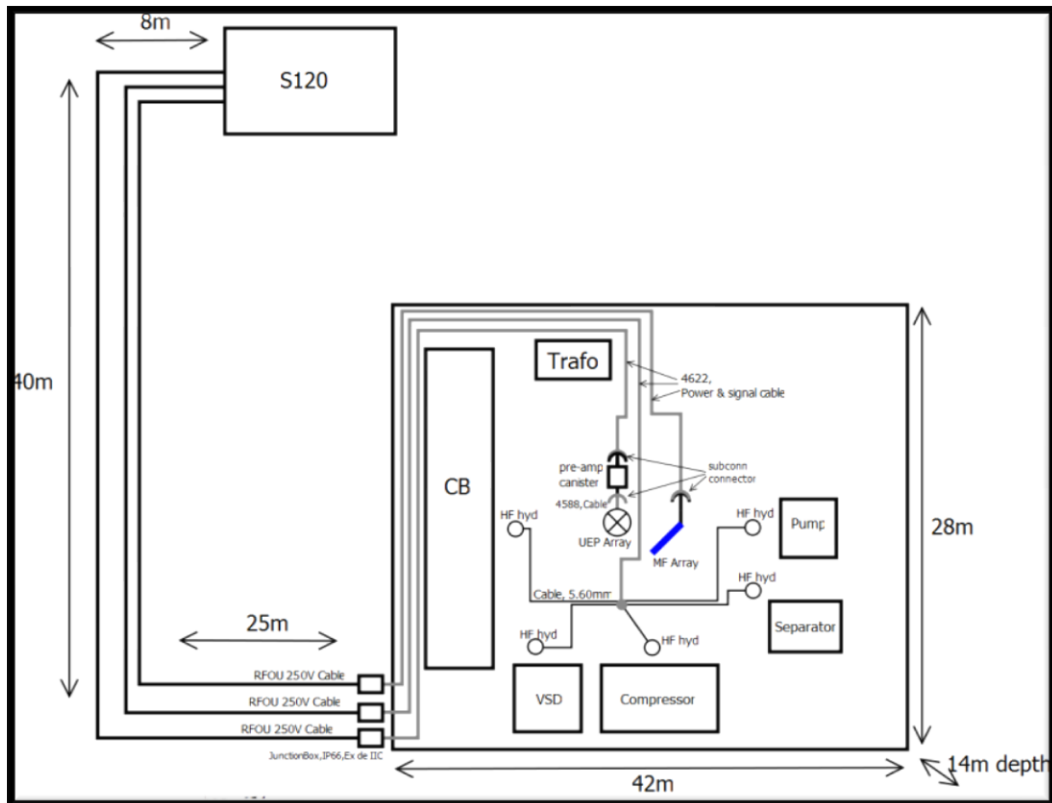

Figure 10.1: Proposed system layout for the monitoring equipment at the Nyhamna test site. It should be noted the illustration of the OLSCP components and their location in the test pit is an approximation.

10.6 TEST EXECUTION

The testing of monitoring equipment is intended to be performed in two phases, where the execution of a second phase is dependent on a successful first phase. The criteria for success are presented in section 10.7.

The first phase is intended to be a “basic function proving phase”, through which it will be checked whether or not baseline signatures from the test object (the Compression Pilot) equipment can be recorded and established in the test pit, and to perform real-time tuning during the commissioning activities. It is planned that the first phase will last from start-up of the OLSCPP and last through all of the commissioning activities.

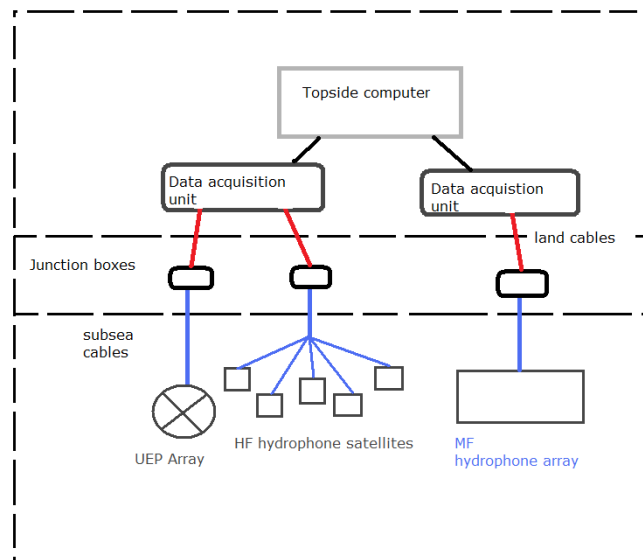

Figure 10.2: Simplified block diagram, showing the basic setup of the monitoring equipment.

The second phase is intended to be more of a “technology improvement phase”, where the possibility to improve filtering and analysis algorithms enhanced tuning and management of secondary effects will be explored. Phase 2 will be subject to a funding review, and is contingent on a successful first phase in order to be executed. It will be run after all of the OLSCPP commissioning activities are done, and the OLSCPP is run under normal conditions. It is not unlikely that the OLSCPP will be run outside of its intended operational envelope at the end of the testing period. This is something that might induce failure of pilot components, giving the possibility to record signatures or equipment failure in the pit.

The system will produce a waste amount of data, in the region of 8 Tb/two weeks. The recorded data will have to be correlated with the commissioning activities in order to be able to extract the most “valuable” data for immediate analysis. This method for data extraction will reduce the workload. The analysis and operation of the monitoring equipment will be remotely performed by Naxys in Bergen. This will be arranged by granting third party access to the local network at Nyhamna. Remote operation reduces the travelling costs, time and emissions, and it is desired that an as large as possible amount of the work is performed by this method.

Due to the large data amount generated, a “clean-up” algorithm is developed. This algorithm will delete data from the computer at a weekly basis, to ensure that there is capacity to store the data generated at all times. The use of a clean-up algorithm requires that the data are continuously downloaded and stored at external hard drives. By getting the updated log of the commissioning activities, analysis will be

performed continuously during the first phase. This will ease the reviewing task at the end of phase 1.

10.7 TEST SUCCESS CRITERIA

As described in section 10.6, the second phase is contingent on a successful first phase in order to receive funding. This, of course, implies that success criteria for the first phase have to be established before the testing begins. The success criteria for phase 1 are split in two elements, covering successful correlation to the OLSCPP commissioning activities and successful data management. These two elements should result in baseline signatures for equipment operational envelopes, identification of processes and results to be presented. Below is a further description of the first phase success criteria.

- 1) Successful correlation with commissioning activities, which should result in the following:
 - a) Establishment of baseline signatures for the operational envelopes of the different equipment. The baseline signatures will be used for comparison in the second phase, and also assist in determining alarm thresholds.
 - b) RPM and slip recognition – this is to be verified by the commissioning log
 - c) Positive identification of flow characteristics, such as e.g. slugs and fines in the OLSCP system. The presence of induced slugs and fines are also to be verified by the commissioning log.
- 2) Successful management of the data generated through:
 - a) Extraction of correct data, at the right time. This data will correlated with the commissioning log, and will be used to generate the baseline signatures.
 - b) Sufficiently effective “clean-up” algorithms to ensure that there is enough storage for the data generated at any given time.
 - c) Successful signal differential from background noise and secondary effects, such as echoes.
 - d) Presentation of analyzed data for a second phase funding review.

Assuming that the first phase success criteria have been met, and that a second phase will be performed, suggestions for second phase criteria for success are made. The suggestions are based on the assumption that all elements in the first phase success criteria are met. The suggestions are given below:

1. Improving algorithms – for better handling of signal super positioning and other secondary effects.
2. Setting sufficient alarm thresholds.
3. Comparing operational signatures of the OLSCP equipment with the baseline signatures established during the first phase.

It should be noted that the second phase success criteria are merely suggestions and that they may be changed if deemed insufficient upon the first phase review.

10.8 CHALLENGES AND LIMITATIONS

There are challenges and limitations related to the project execution. From the view of equipment installation, challenges are related to the limited time windows. The installation will be performed at short notice, even if they are scheduled. This is due to the continuously developing schedule of the OLSCPP. The installation will also be executed in steps, as OLSCPP activities executed at the same time will be having priority.

From the equipment side, the cable lengths represent a new challenge. Naxys has never performed tests using total cable lengths of 180 m for transmission of analog signals before. There are worries that the signal integrity will be affected over these lengths, as transmitted voltages are low (maximum 15 V). Signals from the UEP sensors will be amplified to keep this effect at the minimum for the electromagnetic measurements. However, the effect of cable lengths on acoustic signals is still unknown.

The vibration monitoring will be done by medium frequency hydrophones. These record frequencies in the range from 500 Hz – 20 kHz in which rotational malfunctions, excess vibrations and valve operations are commonly found. However, if incipient malfunctions are to be found in a lower range (10 Hz – 500 Hz) this information will not be recorded by the test setup.

Network stability will be an issue when controlling the system and extracting data remotely. The use of an automatic clean-up algorithm to ensure sufficient storage for the data generated at all times, the data needs to be extracted on a scheduled basis. The result of a network failure could potentially result in the loss of valuable data during the time through which the network has failed.

The success of the monitoring project will also rely on getting a detailed commissioning log from the Compression Pilot. If, for some reason, the log is not properly kept or it is not handed over, correlation of acoustic and electromagnetic signatures with the different commissioning activities will be difficult. In addition to this, time stamps on the recorded signatures should be synchronized with time stamps on the commissioning log. If any mix-up should occur here, confusion and misinterpretation could be the result.

11. BENEFITS AND LIMITATIONS

This chapter sums up different benefits and limitations related to the testing of monitoring equipment described in this thesis. The perceived benefits and limitations are identified through study of equipment and physics, and the project planning process. They are by such *not* based on test results.

The benefits are presented in two sections, the first section is related to the test concept – herein the test object (the OLSCPP) and monitoring equipment - , whereas the second section will be perceived benefits from a potential success.

11.1 CONCEPT RELATED BENEFITS

This section gives the benefits related to the monitoring equipment, the test object and the general test concept. A short description is given to each element in the list.

1. The test location:
The testing will be done in a test pit on land. This gives closer proximity to the test facility and increased availability/accessibility to the test monitoring system, as no vessel is required for installation or potential interventions. Of course, shipping, installation and intervention costs are reduced by this.
2. The test object:
The Compression Pilot is complex, and will run through different modes of operation during its commissioning. This gives the possibility to monitor several pieces of equipment, both simultaneously and individually, and also to develop the filtering algorithms of the signal processing.
3. The commissioning log:
A log will be generated from the commissioning of the OLSCP. This log will contain information on vital functions, such as RPM's, vibration frequencies, fluid flow rates and more, all of which will be marked with a time stamp. The information offers a unique opportunity to correlate the recorded acoustic and electromagnetic signals to exact operations. This can help prove that RPM and slip recognition by the monitoring system is possible. As the log will contain vibration frequencies from the OLSCP accelerometers, this can be used for verification towards acoustically detected vibrations.
4. Qualified technology:
The technology selected for testing is already qualified for subsea use. The project does not require new technology to be developed, but aims at extending the function of the existing technology by applying new algorithms to the signal processing. This reduces the time to and cost of preparing the monitoring equipment for testing.

5. Remote connection:

The operation of the monitoring equipment will be done remotely by Naxys in Bergen. This will reduce travelling cost, time and emissions. The number of site visits will be reduced to a minimum. This is also desired from an HSE point of view.

6. Low risk:

The project is considered to be low risk due to;

- No expected emissions from the monitoring system. However, a small amount of oil can leak from the hydrophones and into seawater in the test pit, if they are cut or damaged in other ways. Standard Nyhamna required PPE is considered as sufficient protection for personnel.
- The monitoring system will not give any form of radiation.
- The equipment used is all small and lightweight (maximum 50 kg), meaning that no heavy lifting will be required during installation. Because the components are small, all equipment can be put in a work basket and lifted in one operation.
- The equipment will be weighed down in the pit, to ensure that the current from circulating seawater does not affect it. Concrete blocks will be used for this.
- The equipment does not require any interface to the Compression Pilot and will not disturb the commissioning activities.

Risk adding factors are described under “limitations”.

7. (Relatively) low cost:

The project will be carried out at a relatively low cost. If successful, a new subsea monitoring technique can be developed without major spending.

8. Remote system:

The monitoring system does not require any physical interface to the Compression Pilot. This, and the fact that the equipment will be weighed down rather than bolted to the pit floor, makes it easy to move the equipment “out of the way” if necessary. It also means that the sensors will be equally focused to each of the pilot’s active components (see chapter 7).

11.2 PERCEIVED BENEFITS FROM SUCCESSFUL TESTING

This section presents the perceived benefits gained from successful testing. These benefits are built on the assumption that a new subsea condition monitoring technique is developed as a result of the test. Some of these benefits are also described in chapter 2 – Condition monitoring. The reason for their inclusion here is that they apply both when a condition monitoring unit is utilized as the only, primary system, and when the condition monitoring unit is added as a secondary system.

1. Improved equipment knowledge:
This can help to optimize the performance of the processing equipment and assist in the maintenance management. This can result in:
 - Reduction in intervention costs
 - Reduction in unplanned interventions
 - Reduction in maintenance frequency
 - Additional time to plan interventions

2. Early fault detection:
If a fault is detected early enough, operational parameters such as e.g. RPM and flow rate can be tuned to push the equipment away from the failure mechanism, in order to perform maintenance in benign conditions at a later time. This is especially true for any vibration induced failure modes, as RPM and flow rate will influence on the vibration frequency of the equipment. The opportunity to mitigate the immediate need for intervention during the months of harsh conditions is valued from an HSE point of view – heavy modules in heavy waves impose a higher risk than in the more benign environment during the summer – and from a cost perspective.

If tuning cannot be done for the specific failure detected, isolation (shutdown) of the equipment and intervention at an early stage can prevent secondary damages to other pieces of processing equipment.

3. Verification of primary system:
In most cases a primary monitoring system consisting of conventional sensors will be in place, and the acoustic system used as a redundant system. This means that the acoustic system can work as a secondary diagnostic tool to verify data from the primary system, and also to confirm sensor failure in the primary system. If a primary sensor fails, verification from the acoustic system might be enough to avoid retrieval of functioning equipment.

4. Multifunction:
The acoustic system will combine the “government required” leak detection system with condition monitoring, increasing the range of function of one system. The monitoring system will be capable of monitoring several pieces of equipment at any given time, a feature which reduces the need for difficult technical solutions with regards to cabling and interfaces.

5. Detection of performance loss:
The monitoring system will be able to trend the data gathered. Comparison of trended data with baseline signatures will make it possible to detect gradual performance loss, potentially over a shorter time period than what is currently possible.

6. Post-installable:

The monitoring system will be post-installable, meaning that it can be retrofitted at existing subsea structures. In addition, because the system's function will depend on signal filtering and analysis, the unit can be updated remotely, without retrieval.

11.3 TEST CONCEPT RELATED LIMITATIONS

The limitations presented here include the risk adding factors from the test concept. Disadvantages related to a future subsea condition monitoring system (given successful testing) are described in section 11.4. As for the benefits, the limitations are listed with a short description.

1. Unknown signal integrity:

For the testing at Nyhamna, total cable lengths of 180 m will be utilized. The monitoring equipment has yet to be tested with lengths of this magnitude, and there are worries that the length will influence on the signal integrity. The current that will run through the cables are very low voltage, making the signals vulnerable for interference.

2. Dependant on information:

The method of testing implies that the result is dependent on getting high resolute information from the commissioning log. This means that communication with the OLSCPP commissioning team is required to be well handled during the entire project. If, for some reason this information is not delivered, the project is deemed to be unsuccessful.

3. Limited time window for installation:

Installation will happen at short notice. If for some reason the equipment is not ready to be mobilized when required, the opportunity to install will be lost. This is one of the larger risks to the project. The time windows are limited due to the fact that the completion of the OLSCPP has priority, thus the installation of the monitoring equipment will be executed "in between".

4. Dependant on stabile network:

Because a clean-up algorithm will be used to ensure sufficient storage for the data generated during testing, and because data extraction will be performed remotely, the project is dependent on stabile network. This is also one of the larger risks to the project, as the result of lost network connection can be loss of valuable data. As means to mitigate this risk, data can also be stored on external hard disks and transmitted by mail.

5. No failure induction:

It is given that no failures (e.g. bearing failures) will be induced to the OLSCP. This means that fault detection cannot be proven, unless something "goes

wrong” during the OLSCP commissioning or testing. However, induction of slugs and introduction of fines will be part of the commissioning activities, and will be found in the log.

6. Acoustic propagation properties:

Reflections and backscattering in the test pit makes determination of sound source impossible. This means that the commissioning log will be important in order to analyze the signals. The short distances in the pit will also make it difficult to separate echoes from the primary signal coming directly from the OLSCP components.

The speed of sound influences the signal processing. Changes in salinity and temperature in the test pit can lead to variations in the speed of sound. However, in signal processing the speed of sound is assumed to be constant over a small area. This gives a negligible error to the signal processing.

7. No low frequency hydrophones:

Vibrations in the range from 10 Hz – 500 Hz will not be recorded, as there will not be utilized any low frequency hydrophones. Thus, information found in this range will be lost.

11.4 LIMITATIONS OF FUTURE SYSTEM

Limitations related to a future condition monitoring system are presented in this section.

1. Loss of data:

When transmitting raw data, new data will not be accumulated in the subsea system until all buffered data has been transmitted. This means that there is potential to lose important data and information of failures.

2. Reaction to disturbances:

As explained in chapter 5, the presence of ROV's near the subsea structure monitored by an ALVD can result in false alarms. This limitation is easy to overcome, as ROV presence will be known.

3. Location requirement:

The monitoring system will require to be installed centrally in order for one system to monitor an entire structure. The system will be vulnerable to signal shading, as this will decrease the ability to determine the sound source.

4. Fault recognition:

In order to recognize a failure mode, the system is dependent on having a database with signatures for different failures to compare with. Even with such a database the identification of a certain failure mode can be difficult. However, even if a specific failure mode cannot be identified, it can still be

detected that a failure is present.

5. Echoes:

The system will be subject to echoes from the structure itself, although the effects of this when testing ALVD at Ormen Lange templates have been demonstrated to be minimal.

6. Ambient background noise:

It will not be possible to isolate signal frequencies below that of the ambient ocean background noise with the current filtering algorithms. Information found at these frequencies is therefore currently unavailable.

12. RECOMMENDATIONS FOR FURTHER STUDIES

Before deciding on further studies, it is suggested that results from the Nyhamna testing is reviewed. If it is decided that testing is to be continued for further proving and verification of the system's capability, this can be done in two ways:

The first, systematic method will be to perform more narrow experiments, where failure modes are introduced to different types of processing equipment. The failure modes selected for introduction should come from studies of FMECA/FMEA of the equipment – meaning that there should be a possibility for the introduced failure mode to actually occur in operated equipment. The failures can then be introduced in two ways, either by direct introduction (e.g. such as putting sand in a roller bearing) or by introduction of the failure mechanism. Experimenting with different types of equipment and failure modes should give a further understanding of the range of function the monitoring system has capability for, and which failure modes it is unable to detect. In addition to failure modes, different processes can be introduced and monitored for. Cavitation is one of the processes this should be done for due to its large effect.

The second method assumes that subsea compression is qualified and selected as concept for the Ormen Lange Future Compression. In such a case, the monitoring system can be deployed as a test unit, and meet the requirement for subsea leak detection at the same time. However, this method will be subject to the same limitation as the test unit at Nyhamna – no failure modes will be intentionally induced to the future compression station.

Out of the two methods, the first is more likely to yield comprehensive and conclusive results on how well the monitoring system is capable of performing. It is also the only method to determine which failure modes that are within the range of detection capability for the system. However, the systematic method will be much more costly than the second.

13. DISCUSSION

As described initially in this thesis, the overall objective is to evaluate the benefits of performing an extended function test of acoustic (complemented by electromagnetic) sensing technology for use as a diagnostic tool for subsea processing equipment and operational characteristics in conjunction with the Ormen Lange Subsea Compression Pilot Project (OLSCPP). By studying the current function of the technology to be tested, the physics involved and the test object failure modes, benefits and limitations have been identified.

The fact that no failure modes will be intentionally introduced in the OLSCPP makes it impossible to achieve 100 % success (as it is defined in section 10.2), as positive failure mode identification cannot be proven by the testing described. This can only be achieved through methodical and systematical testing with specific failure modes for different types of processing equipment (as briefly described in chapter 12). There is confidence that the monitoring project will result in extended function of the monitoring technology tested. This can be in terms of performance loss monitoring, verification of primary data or the detection of malfunction.

If detection of gradual performance loss, i.e. performance monitoring is obtained, it can be developed into a helpful tool in terms of maintenance and intervention planning. It can offer the possibility to plan for early intervention or to decide on postponing intervention until it can be executed in benign conditions in the months of April – November. The opportunity to improve the planning can help mitigate long periods of shutdown due to equipment breakdown during the remaining time of the year when intervention is more difficult.

If the outcome of testing is 100 % unsuccessful (see 10.2), the project can still be claimed to be value adding. This is due to the increased knowledge that will be obtained about the existing function of the ALVD, which can be used to increase sensitivity and level of detail towards detection of small leakages.

The use of the Compression Pilot as test object helps to keep the costs of the project low, as no designated processing equipment will have to be procured for the testing. However, this of course limits the monitoring project to operate within the boundaries of the OLSCPP, thus limiting the project from methodical testing. The fact that the Compression Pilot will be commissioned during the test period, offers a one in a kind opportunity to record signatures and correlate them with known data, which will help identify the range of monitoring capability. Thus, the testing can be used for deciding whether further funding for systematic and methodical testing towards failure mode detection and identification is to be recommended.

When studying the failure modes for the active components of the OLSCP, the failure modes identified as suitable for acoustic detection are seen to have low or medium probability of occurring. However, most of these are not monitored for, meaning that a system capable of detecting them can be valuable.

BIBLIOGRAPHY

- A/S Norske Shell (Wells). (2011, 04 18). Discussion with engineers in Wells department. .
- Aarvik, A., Halvorsen, V. G., & Bjerkreim, B. (2008). *Subsea compression functional requirements (doc.id. 37-1b-NHT-x15-00018, StatoilHydro)*.
- Abrahamsen, J. H. (2007). Ormen Lange Subsea Condition and Leakage Monitoring SPE 108970. *Offshore Europe 2007*. Aberdeen: Society of Petroleum Engineers.
- Abrahamsen, J. (n.d.). <http://www.worldoil.com/April-2007-Norway-Acoustic-diagnostics-improve-condition-leakage.html>. Retrieved 02 03, 2011
- Aker kværner. (2007, April 3rd). (Subsea compressor) functional design document (doc.id 37-1Y-AKS-M85-71201-0001).
- Aker Kværner. (2008, May 19th). FMECA for Pump Module - Ormen Lange Condesate Pump (doc.id. 37-1Y-AKS-F15-71202-0001). unpublished.
- Aker Kværner. (2008, March 14th). FMECA of Seperator and Cooler Module (doc.id. 37-1Y-NHT-B45-5322442). unpublished.
- Automatisering*. (2011, January 12). Retrieved March 11, 2011, from <http://www.automatisering.org>:
<http://www.automatisering.org/default.asp?menu=6&id=7303>
- Bernt Bjerkreim, S. F., StatoilHydro, B. N., Shell, H. S., Akersolution, H. G., Vetcogray, A. T., GE oil and gas, M. P., et al. (2009). Ormen Lange Subsea Compression Pilot. *Offshore Technology Conference - OTC 20028*. Houston, Texas 4-7 May: Offshore Technology conference.
- Bjørge and FMC for Statoil Petroleum AS. (2010, October 7th). Hydrophone error detection system - Software technical specification (doc.id. 37-1x-FMC-X50-00018). unpublished.
- Caruthers, J. W. (1977). *Fundamentals of Marine Acoustics ISBN 0-444-41552-1*. Elsevier Scientific Publishing Company.
- David A. Bies, C. H. (2003). *Engineering Noise Control: Theory and Practice (3rd edition) ISBN-0-415-26714-5*. Spon Press.
- DNV. (2010). *Recommended Practice - Selection and use of subsea leak detection system DNV-RP-F302* . Det Norske Veritas.
- Eriksson, K. G. (2010). Control System and Condition Monitoring for a Subsea Gas Compressor Pilot (Scada 10-39) ISBN: 978-0-906940-52-4. *Subsea Control and Data Aquisition (SCADA) conference, June 2-3, 2010* (pp. 39-50). Newcastle, United Kingdom: Society of Underwater Technology.

exploratorium. (n.d.). <http://www.exploratorium.edu/theworld/sonar/sonar.html>. Retrieved January 28 at 12:50 p.m., 2011, from <http://www.exploratorium.edu>.

F. Alton Everest, K. C. (2009). *Master Handbook of Acoustics (5th edition)* ISBN-978-0-07-160332-4. The McGraw-Hills Companies Inc.

FederationofAmericasScientists. (2011, January 28). <http://www.fas.org/man/dod-101/navy/docs/fun/part08.htm> accessed 10:26 28.01.2011. Retrieved January 28, 2011, from <http://www.fas.org>.

FMC, Bjørge, & Statoil. (2010). *Hydrophone error detection system - Software technical specification DOC.ID: 37-1x-FMC-X50-00018*. unpublished - internal document.

GE O&G. (2006, February 3rd). Reliability Study - Ormen Lange Subsea Compressor train - mean time to failure evaluation doc.id. 8999583. unpublished.

Gundersen, S. S. (2004). *Acoustic Condition Monitoring of Subsea Multibooster*. Trondheim: NTNU M.Sc Thesis.

Haugen, S. A., & Naxys. (2004). *Akustisk overvåkning av undervannsinstallasjoner - konseptstudie for Statoil*. Naxys - Doc.id. 066-005-005.

Hoffman, F. (1997). *An introduction to fourier theory*. Retrieved 02 03, 2011, from http://lanoswww.epfl.ch/studinfo/courses/cours_dynsys/extras/Hoffman%281997%29_An_Introduction_to_Fourier_Theory.pdf

<http://www.wirelessfibre.co.uk>. (n.d.). Retrieved March 14, 2011, from <http://www.wirelessfibre.co.uk/Content/press/articles/Hydro%20International%20Dec%2006.pdf>

Håkon Skofteland, M. H., ConverTeam, m. P., & GE Oil&Gas, M. C. (2009). Ormen Lange Subsea Compression Pilot - Subsea Compression Station. *Offshore Technology Conference - OTC 20030*. Houston, Texas 4-7 May: Offshore Technology Conference.

ISO 13372:2004. (2004). *Condition monitoring and diagnostics of machines - Vocabulary*. International Organization of Standardization.

ISO 17359:2003. (2003). *Condition monitoring and diagnostics of machines - general guidelines*. International Organization for Standardization.

John H. Steel, S. A. (2009). *Measuremetn techniques, sensors and platforms: A derivative of encyclopedia of ocean sciences* ISBN 978-0-08-096487-4. Elsevier.

Johnson, P. D. (2002). *Principles of Controlled Maintenance Management* ISBN 0881733547. Fairmont PR.

L. Galli, B. H. (n.d.). *Boat Source-Level Noise in Haro Strait: Relevance to Orca Whales*. Retrieved 02 02, 2011, from <http://www.coloradocollege.edu/dept/ev/research/faculty/OVALitems/FinalRptWeb/finalAll.html>.

- L. M. Brekhovskikh, Y. P. (2003). *Fundamentals of Ocean Acoustics* ISBN-0-387-95467-8. Springer Verlag.
- Lurton, X. (2002). *An Introduction to underwater Acoustics - Principles and Applications* ISBN 3-540-42967-0. Chichester, United Kingdom: Praxis Publishing Ltd.
- Mechefske, C. K. (2010, september 13). Lecture on Machine Condition Monitoring and Fault Diagnostic Online document:
<http://me.queensu.ca/courses/MECH826/documents/MECH826-Week01-MaintenanceStrategies.pdf> Accessed 8:30 a.m. January 27th 2011. Queen's University Mechanical Engineering.
- Medwin, H. (1975). *Journal of Acoustical Society of America* Vol. 58 , 1318-1319.
- Naxys AS (Frank Sæther). (2011, 04 19). E-mail correspondance.
- Naxys AS. (2011, Jan 20). presentation at Naxys workshop by J. Abrahamsen. .
- Naxys. (2011). Communication with Naxys - spring of 2011.
- Norton, M., & Karczub, D. (2003). *Fundamentals of Noise and Vibration Analysis for Engineers* ISBN 0521499135. University Press, Cambridge.
- Nuovo Pignone for AKER Kværner. (2009, june 6). Compressor detailed specification (Doc.id. 37-1Y-AKS-M50-71201-0004. Unpublished - internal document.
- Peter J. Tavner, L. R. (2008). *Condition Monitoring of Electrical Rotating Machines* ISBN - 978-0-86341-739-9. London, United Kingdom: The Institution of engineering and technology.
- Raichel, D. R. (2006). *The science and applications of acoustics* ISBN-10: 0387260625. Springer Science+Business Media, Inc.
- Rao, B. (1996). *Handbook of Condition Monitoring* ISBN - 1-856-17-234-1. Oxford, United Kingdom: Elsevier Advanced Technology.
- Shell (Director). (2010). *Animation: Subsea Compression Test Facility - Walk through test site pilot* [Motion Picture].
- ShellPictureDatabase. (2011). Misc. Ormen Lange Pictures.
- Smith, A. (2006). *Acoustic Monitoring of 316 L and Duplex Stainless Steel Pipeline (Report no. O-1904, Lloyd's register EMEA)*.
- StaoilHydro. (2008, October 10th). Subsea Compression Functional Requirements doc.id. 37-1B-NHT-X15-00018. *unpublished* .
- StatoilHydro - Hydro Oil & Energy Projects. (2008, February 4th). ALVD User Manual Doc.Id.: 37-1B-FMC-X04-00069 Rev. 02I. *Unpublished* .

StatoilHydro (presentation by Bernt Bjerkreim). (2008, April). Subsea Compression Pilot - Ormen Lange Offshore. unpublished.

StatoilHydro, Aker Solutions. (2009). *Ormen Lange Subsea Compression Station Pilot - Pump Module detailed Specification Ormen Lange Condensate Pump (doc.id. 10000405448-PDC-000)*.

ABBREVIATIONS

- **ALVD:** *Acoustic Leak and Vibration Detector, a monitoring unit delivered by Naxys AS to (amongst others) Ormen Lange.*
- **AMB:** *Active Magnetic Bearing*
- **AT/SJA:** *Arbeidstillatelse/Sikker Jobb Analyse (Work Permit/Safe Job Analysis)*
- **EFAT:** *Extended Factory Acceptance Test*
- **FAT:** *Factory Acceptance test*
- **FMEA:** *Failure Mode Effects Analysis*
- **FMECA:** *Failure Mode Effects and Criticality Analysis*
- **HSE:** *Health, Safety and Environment*
- **MEG:** *Mono ethylene glycol, commonly used for flow assurance (gas hydrate prevention). For the OLSCPP also used as a cooling barrier fluid in the LiquidBooster™ pump.*
- **MPF:** *Measured Power Frequency*
- **NPSH:** *Net Positive Suction Head*
- **NPSHA:** *Net positive Suction Head Available*
- **NPSHR:** *Net Positive Suction Head Required*
- **OLSCP:** *The Ormen Lange Subsea Compression Pilot.*
- **OLSCPP:** *The Ormen Lange Subsea Compression Pilot Project, a large scale qualification test project for subsea process equipment performed at the premises of the onshore process facility at Nyhamna this year (2011).*
- **PEP:** *Project Execution Plan*
- **PPE:** *Personal Protective Equipment*
- **RPM:** *Revolutions per minute.*
- **SPF:** *Supplied Power Frequency*
- **UEP:** *Underwater Electric Potential*
- **VSD:** *Variable speed drive.*
- **WIP:** *Water Injection Pump*

DEFINITIONS

- **Acoustic Intensity:** *Acoustic energy amplitude.*
- **Baseline signature:** *The acoustic or electric “fingerprint” of healthy equipment or processes when running under normal operational conditions, i.e. the equipment’s basic trends during normal operation.*
- **CanBus:** *Communication line enabling controls and equipment to communicate without a host communication.*
- **Condition monitoring:**
- **Footprint:** *Area needed to install equipment at pit floor/seabed.*
- **Hertz:** $1 \text{ Hz} = 1 \text{ s}^{-1}$
- **Infrasonic:** *Utilization of sound frequencies below the human hearing limit, 20 Hz. For humans to perceive these frequencies the sound pressure must be sufficiently high.*
- **IWIS:** *Intelligent Well Interface Standardization*
- **Operational characteristics:** *Process behaviors such as cavitation, slugging flow and sand production.*
- **Permittivity:** *Permittivity is a term for the dielectric constant, a measure of how much resistance is encountered when forming an electric field in vacuum, and therefore of how easy it is to establish electric flux in a material.*
- **Slip ratio:** *Performance loss [%], causing loss in flow. Performance loss is caused by fluid flowing back through pump clearances towards the inlet. Slip will increase with clearance size and pressure, and decrease as viscosity increases. Slip ratio can be calculated based on supplied electric frequency and the measured acoustic from the equipment, as shown in section 2.4.*
- **Sound velocity profile:** *Sound velocity plotted as a function of sea depth.*
- **Spatial change:** *Change in space; for sound velocity profiles this means that at a certain depth z_1 at specific x_1 and y_1 the sound velocity might be different from the sound velocity at z_1 , x_2 and y_2 .*
- **Topside:** *In this thesis, it is not differentiated between topside and landside, as the difference between the two only depends on type of field development and not the monitoring equipment properties.*

LIST OF FIGURES

Figures are listed after the chapters that they are found in and followed up by a reference no. for the actual figure. An example is Figure 4.1 which refers to the first figure in chapter 4.

- **Front page:** View of the onshore gas processing plant at Nyhamna – the subsea compression test site can be seen in the left lowermost corner. (Shell, 2010)
- **Figure 2.1:** The maintenance strategies, as divided by Peter J. Tavner. (Self made after (Peter J. Tavner, 2008))
- **Figure 2.2:** The different groups of condition monitoring techniques. (Based on (Rao, 1996)). The technology considered in this thesis can be said to combine vibration and noise monitoring into one technique, where vibrations are indirectly monitored by utilizing vibration induced noise frequencies.
- **Figure 2.3:** WIP slip ratio from Troll Pilot (Gundersen, 2004)
- **Figure 3.1:** EM waves capability to travel through different propagation mediums. (<http://www.wirelessfibre.co.uk>)
- **Figure 4.1:** Spherical geometric spreading principle (self made after (Lurton, 2002)). **Figure 4.2:** Some animals have their own built-in active acoustic system. (exploratorium)
- **Figure 4.3:** The principle of the hydrophone's function. (L. Galli)
- **Figure 5.1:** General overview of the ALVD system installed at the Ormen Lange templates. (StatoilHydro - Hydro Oil & Energy Projects, 2008)
- **Figure 5.2:** Areas of frequencies and the information they contain. LF = low frequency, MF = medium frequency and HF = high frequency. (Haugen & Naxys, 2004)
- **Figure 5.3:** An Ormen Lange ALVD unit. The system is complete with IWIS and CanBus connection, and a redundant hydrophone array. (Bjørge and FMC for Statoil Petroleum AS, 2010)
- **Figure 5.4:** Example of the FFT principle. (Automatisering, 2011)
- **Figure 5.5:** Snapshot of the template monitoring page in the user interface for an Ormen Lange ALVD. (StatoilHydro - Hydro Oil & Energy Projects, 2008)
- **Figure 5.6:** An ALVD unit with electromagnetic field sensors (UEP) as will be deployed at Pazflor, an offshore oil field in Angola. (Naxys, 2011)
- **Figure 5.7:** Figure 5.7: Picture from ALVD FAT at Naxys Quay side in Bergen. (Naxys, 2011)The picture gives an indication of the physical size of the ALVD unit. The picture gives an indication of the size of the ALVD unit. The bar hanging beneath the unit is a commissioning tool, consisting of a speaker and a hose. The commissioning tool is used to make artificial leak and vibration signatures.
- **Figure 5.8:** Pump The signature of the pump with damaged bearing is presented in red, and compared to the blue baseline signature. (Naxys, 2011)
- **Figure 5.9:** The red curve presents the curve from the pump run with corroded impellers, whereas the baseline signature is presented in blue. The spike at 40 Hz indicate impeller imbalance due to the corrosion. (Naxys, 2011)

- **Figure 6.1:** UEP sensor frame for installation in the test pit at Nyhamna. (Naxys AS (Frank Sæther), 2011)
- **Figure 7.1:** Overview of the Ormen Lange field: Subsea production templates and tie-back to onshore process facility. The red boat is the drill ship West Navigator. (ShellPictureDatabase, 2011).
- **Figure 7.2:** The test pit at Nyhamna. (Shell, 2010)
- **Figure 7.3:** Layout of the OLSCPP in the test pit. Notice the bus, which is added to illustrate the size of the pilot equipment. (Eriksson, 2010)
- **Figure 7.4:** The pilot equipment without steel frame. (ShellPictureDatabase, 2011)
- **Figure 7.5:** Ormen Lange Subsea Compression Pilot flow diagram and overview. (Eriksson, 2010)
- **Figure 7.6:** The pump module. (StatoilHydro (presentation by Bernt Bjerkreim), 2008)
- **Figure 7.7:** The compressor module. (StatoilHydro (presentation by Bernt Bjerkreim), 2008)
- **Figure 7.8:** The separator vessel during construction. (ShellPictureDatabase, 2011)
- **Figure 7.9:** The separator module. (StatoilHydro (presentation by Bernt Bjerkreim), 2008)
- **Figure 7.10:** An illustration of the anti-surge cooler module. (StatoilHydro (presentation by Bernt Bjerkreim), 2008)
- **Figure 8.1:** The project planning process during the spring of 2011.
- **Figure 8.2:** The project timeline as of May 2011.
- **Figure 9.1:** Compression Pilot condensate pump module without pump in test pit at Aker Solutions facilities in Tranby, Lier for 100 hour full load test.
- **Figure 10.1:** Proposed system layout for the monitoring equipment at the Nyhamna test site. It should be noted the illustration of the OLSCP components and their location in the test pit is an approximation.
- **Figure 10.2:** Simplified block diagram, showing the basic setup of the monitoring equipment.

LIST OF TABLES

Tables are listed in the same way as the figures.

- **Table 5.1:** Specifications of the ALVD unit for Ormen Lange. (Naxys AS, 2011)
- **Table 7.1:** Selected design parameters (StatoilHydro, Aker Solutions, 2009).
- **Table 7.2:** This is a selection of the compressor module's specifications. (Nuovo Pignone for AKER Kværner, 2009)
- **Table 7.3:** Selected design specifications for the subsea separator. (Aarvik, Halvorsen, & Bjerkreim, 2008)
- **Table 7.4:** Selected failure modes for the separator module suitable for acoustic detection. (Aker Kværner, 2008)
- **Table 7.5:** Selected failure modes for the anti-surge cooler suitable for acoustic detection. (Aker Kværner, 2008)
- **Table 7.6:** Selected failure modes suitable for acoustic and EM detection for the subsea pump module. (Aker Kværner, 2008)
- **Table 7.7:** Compressor failure modes potentially suitable for acoustic detection. (GE O&G, 2006)
- **Table 7.8:** Issues identified for the OLSCPP equipment by discipline engineers.
- **Table 7.9:** A selection of milestones with comments, from the OLSCPP schedule, as of January 2011.
- **Table 7.10:** A selection of milestones with comments, from the OLSCPP schedule, as of May 2011, in less detail than table 7.9.
- **Table 8.1:** Simplified project budget.
- **Table 10.1:** Requirements and exceptions for the project

EQUATIONS

All equations mentioned or described in this thesis are gathered in this section.

1. For calculation of RPM and slip ratio (chapter 2):

$$Speed = SPF [Hz] \times 60 \left[\frac{Seconds}{min} \right] \quad (Eq. 2.1)$$

$$Speed = 39.60 [Hz] \times 60 \left[\frac{Seconds}{min} \right] = 2376 RPM$$

$$Slip = \frac{MPF [Hz] - SPS [Hz]}{MPF [Hz]} \times 100 \% \quad (Eq. 2.2)$$

$$Slip = \frac{39.72 [Hz] - 39.60 [Hz]}{39.72 [Hz]} \times 100 \% = 0.3 \%$$

2. Maxwell's four equations for propagation of electromagnetic waves through seawater (chapter 3):

$$\nabla \cdot \mathbf{D} = \rho_f \quad (Eq. 3.1)$$

$$\nabla \cdot \mathbf{B} = 0 \quad (Eq. 3.2)$$

$$\nabla \times \mathbf{E} = -\frac{\partial \mathbf{B}}{\partial t} \quad (Eq. 3.3)$$

$$\nabla \times \mathbf{H} = \mathbf{J}_f + \frac{\partial \mathbf{D}}{\partial t} \quad (Eq. 3.4)$$

In these equations \mathbf{D} = electric displacement vector, ρ_f = free electric load per volume, \mathbf{B} = magnetic field, \mathbf{E} = electric field, \mathbf{H} = magnetic intensity and \mathbf{J}_f = free electric density

3. Helmholtz' equation used for acoustic wave propagation (chapter 4):

$$\Delta p = \frac{\partial^2 p}{\partial x^2} + \frac{\partial^2 p}{\partial y^2} + \frac{\partial^2 p}{\partial z^2} = \frac{1}{c^2(x,y,z)} \frac{\partial^2 p}{\partial t^2} \quad (Eq. 4.1)$$

If velocity can be considered as a constant, then $c(x,y,z) = c$, and if propagation only exists in a single direction x equation 4.1 is reduced to equation 4.2.

$$\Delta p = \frac{1}{c^2} \frac{\partial^2 p}{\partial t^2} \quad (Eq. 4.2)$$

4. Equation for calculating the sound velocity in the ocean (chapter 4):

$$C = 1449.2 + 4.6T - 0.00029T^3 + (1.34 - 0.010T)(S - 35) + 0.016z \quad (\text{Eq. 4.3})$$

This equation is valid for the following ranges of T, S and z: T = {0°C - 30°C}, S = {0‰ - 45 ‰} and z = {0 m - 1000 m}.

5. Equation for calculating wavelengths (chapter 4)

$$\lambda = \frac{c}{f} \quad (\text{Eq. 4.4})$$

$$\lambda = \frac{1,500 \frac{m}{s}}{20 s^{-1}} = 75 \text{ m}$$

λ = wavelength, c = sound velocity and f = frequency.

APPENDIX 1: PROJECT EXECUTION PLAN

The following 10 pages contain a “condensed” version of the Project Execution Plan. Note that the document in this appendix is not the full project execution plan, but a modified version where proprietary information has been removed.

Removal of proprietary information is due to the desire to keep the thesis unrestricted.



A/S Norske Shell E&P Ormen Lange

Title

Project Execution Plan

Acoustic and EM Monitoring for Ormen Lange

0	08.06.2011	For information	Beate Midtun		Bruce Wilson	Bruce Wilson
Rev.	Date	Reason for Issue	Author	Org. Unit	Verified	Approved
Doc. No				Owner		
Discipline				Doc. Type		
Process				Level		
Area Code				System Code		
Tag No.				Project Code		

	A/S Norske Shell E&P Ormen Lange	
	Doc. No.	
	Page 100 of 10	
	Rev : 0	Rev. Date: 08.06.2011

1.0 Objective

The objective of the project is to extend the function of the acoustic leak and vibration detection (ALVD) technology currently in use at Ormen Lange templates. The aim is to develop the technology into a remote – functioning secondary diagnostic tool for equipment already monitored and to provide first hand information on equipment function and processes for which no means of monitoring currently exists. The objective is based on the perceived need to make corresponding advances in monitoring technology as the complexity of subsea developments increases. The acoustic technology will be complemented by electromagnetic (EM) sensors, for “triangulation” with the aim of enhancing the level of resolution in the diagnostic picture.

Testing of the monitoring equipment will be performed in the test pit for the Ormen Lange Subsea Compression Pilot, a target selected due to its complexity, and due to the fact that the commissioning will result in a detailed log of time-stamped activities and induced processes. Another influencing factor is that the pilot will be commissioned and tested in a shallow test pit on land reducing, costs and minimizing technical challenges of testing the monitoring equipment simultaneously. Small monitoring units will be installed in the test pit to monitor system commissioning. Correlation between the detected signals and the commissioning log will assist in matching the individual signatures to the correct equipment and processes.

The purpose of this document is to give a high level introduction to the project scope, schedule and work management. The organization of the project (herein roles and responsibilities, management of change and communication) as well as budget and HSE & Q will be presented here.

2.0 Scope

The scope of the project is split in two: one technical part and an organizational part. The technical part of the scope includes scope of work for installation and execution of the testing, whereas the organizational part includes framework, assurance and risk aspects, interfaces and communication.

Technical

A high level scope of work for the installation and test execution is presented here. Figure 1 shows the layout of the test equipment. A desktop computer and two data acquisition units (DAQ's) are to be installed topside in the instrumentation cabin S120. The DAQ's will provide signal connection to the computer and provide power for the sensing equipment in the test pit. One DAQ will be connected to five satellite high frequency hydrophones and a UEP array, whereas the other DAQ will be connected to a medium frequency hydrophone

	A/S Norske Shell E&P Ormen Lange	
	Doc. No.	
	Page 3 of 10	
	Rev : 0	Rev. Date: 08.06.2011

array. The connection is made by cables.

Three cables will be routed from S120 to the edge of the pit through lidded cable culverts. These cables are of type DRAKA RFOU(i) 250 V. This type is a combined signal and power cable. It is halogen-free, self-extinguishing and mud/oil resistance as required for use at Nyhamna. The appropriateness of its use is verified by the Technical Authority (TA2) for Nyhamna.

At the edge of the pit, the DRAKA cables will be spliced to Macartney 4622 cables via junction boxes. Junction boxes are EXE certified and are also verified by the TA2. The subsea cables are routed into the pit via existing cable trays. At the pit floor, the cables will either follow existing cable trays or be weighed down. The subsea cables are then connected to the sensing equipment as follows:

- High frequency hydrophones have a molded connection to a cable.
- A medium frequency hydrophone array is connected to one cable through a “SubConn” connector.
- UEP (Underwater Electric Potential) array is connected to a pre-amplifier by a SubConn connector. The pre-amplifier is then connected to the subsea cable with a second SubConn connector.

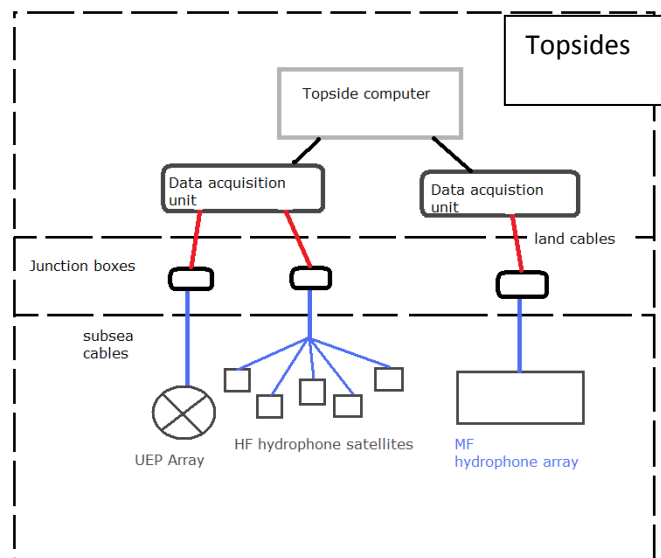



Figure 1: Simplified test system block diagram.

	A/S Norske Shell E&P Ormen Lange	
	Doc. No.	
	Page 4 of 10	
	Rev : 0	Rev. Date: 08.06.2011

To keep each piece of equipment in place at its respective location, concrete weights will be added for additional stability. Beyond that, the equipment is completely remote and requires no physical interface with the compression pilot. The equipment will be located such that the two arrays are placed in the centre of the pit, whereas satellite hydrophones are installed in proximity to the respective components of the Compression Pilot. This is illustrated in Figure 2.

Once the equipment is installed, there is need for a function test. During the function test, power needs to be turned on so that the connection with sensors (i.e. signal detection) can be verified. This is done by tapping each hydrophone with a finger; thereafter the hydrophone's response in the user interface is verified.

As the pit is filled with water, the system is energized and, as the Compression Pilots commissioning activities are executed, real-time tuning of the monitoring equipment is performed. Detected signatures will be processed, analyzed and correlated against the commissioning log. The processed signatures will be subject to review. As the Compression Pilot will be extensively monitored (by conventional integrated sensors), and the data from this monitoring can also be used for correlation and verification of the signatures detected by acoustics and electromagnetics.

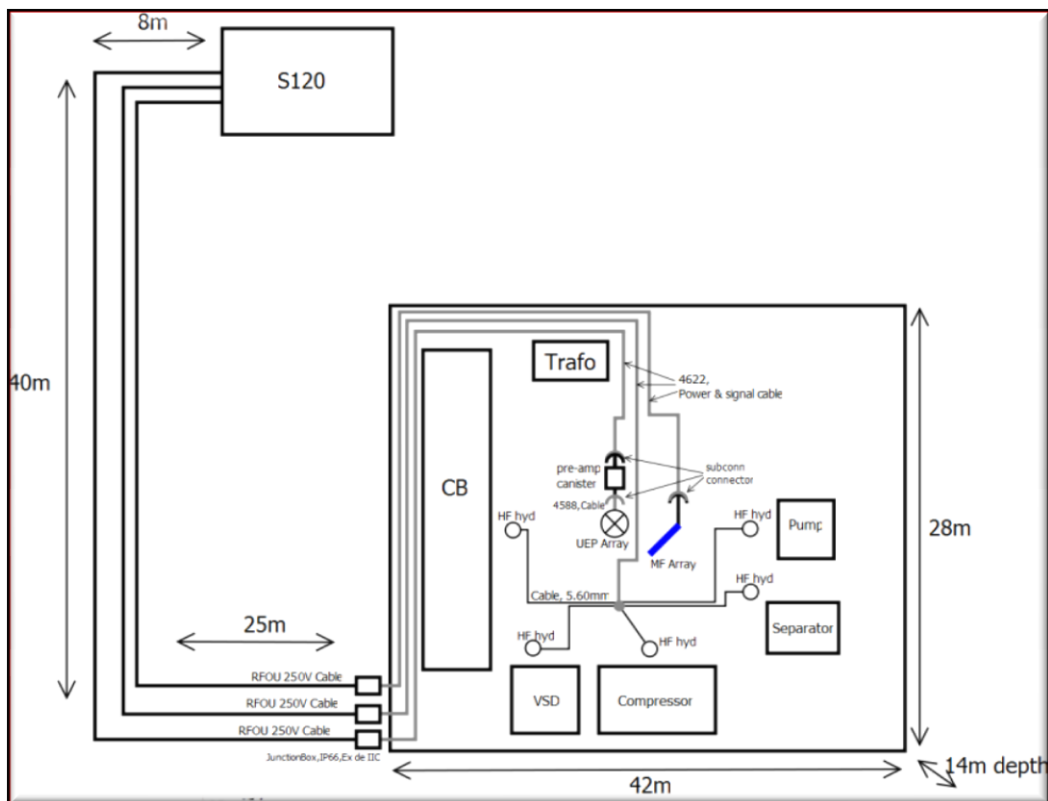



Figure 2: Approximate system layout for the monitoring project.

	A/S Norske Shell E&P Ormen Lange	
	Doc. No.	
	Page 5 of 10	
	Rev : 0	Rev. Date: 08.06.2011

Due to the vast amount of data generated from the monitoring system (4 Tb/Week), a “clean-up” algorithm will be utilized to ensure sufficient storage for the generated data at all times. As a result of this, data will have to be extracted on a scheduled basis to avoid losses. The system will be setup for remote control and operation. However, the amounts of data will be too large for remote extraction and will have to be physically collected on external hard disks.

Project organization

An important element of the acoustic monitoring project is that it takes place within the framework of the Ormen Lange Subsea Compression Pilot. Equipment and activities of the monitoring project are to be carried out within in the regulations of the Compression Pilot. The appropriateness of all equipment and activities is to be checked and verified before installation and test execution.

All risk aspects need to be addressed. The major concern is the possibility of impacting the Compression Pilot in anyway. The probability of this happening considered to be minimal, but this cannot be assumed. All work will be executed in accordance with the regulations for the gas processing facility at Nyhamna.

All installation work will be based upon a job-card system. Aker Solution will produce the job cards on behalf of Shell. The installation will be performed by contractors at Nyhamna, supervised by a Naxys representative. Function testing will be executed by Naxys personnel.

Data extraction, signal processing and system operation will be handled by Naxys. Granting Naxys access to the local network at Nyhamna will enable them to control the system remotely. Regular interface is required between Naxys, the Shell project representative and Pilot commissioning personnel to communicate test procedures and gathered data that can be used to correlate acoustic/UEP readings with data measured from integrated sensors.

3.0 Schedule

The project schedule is – with the exception of cable delivery - dependent on the Compression Pilot’s schedule, as this has priority. The installation schedule is thus subject to changes, meaning that the equipment needs to be ready for installation at short notice. Figure 3 shows a schematic timeline with expected cable delivery date, cable installation, mechanical completion and commissioning. Start-up of the testing will be at the water-filling of the test pit, the date of which is currently uncertain.

	A/S Norske Shell E&P Ormen Lange	
	Doc. No.	
	Page 6 of 10	
	Rev : 0	Rev. Date: 08.06.2011

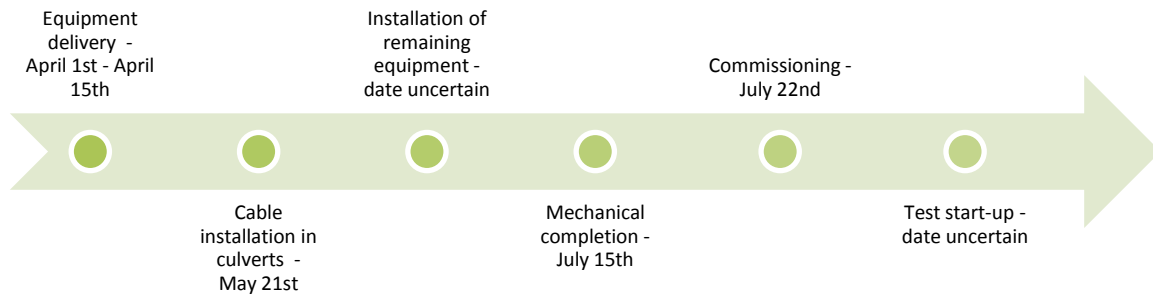

Figure 3: Installation schedule for the monitoring system.

The testing will be performed through both the commissioning and test phase of the Compression Pilot.

4.0 Roles and Responsibilities

The responsibilities are split between Shell and Naxys.

Shell’s responsibilities:

It is Shells responsibility to provide the main part of the funding necessary to the project. Accommodation of installation and test execution, including access to test site and personnel as necessary, are also among Shells responsibilities.

Aker will produce job cards based on installation procedures prepared by Naxys, on contract from Shell. It is Shell’s responsibility to interface with Aker.

The Pilot commissioning team shall provide information on the commissioning activities of the Compression Pilot, to which the recorded signals will be correlated. Regular interface meetings and “lookaheads” will facilitate information transfer.

“Acceptance criteria” are to be defined by Shell, based on a perception of the monitoring equipments capability. This will require Naxys to demonstrate a clear correlation between remote and direct measurements or discernible trends in equipment behavior that are supported by other indirect means.

Shell shall review preliminary test results to decide whether or not to extend the studies for the duration of the Compression Pilot test period.

	A/S Norske Shell E&P Ormen Lange	
	Doc. No.	
	Page 7 of 10	
	Rev : 0	Rev. Date: 08.06.2011

Naxys’ responsibilities:

Naxys is responsible for providing equipment as specified. For equipment that needs to be procured, such as cables and connectors, Naxys will order this upon a P.O. from Shell. The cost of procurement will be split as agreed between Shell and Naxys.

Naxys shall provide the installation procedures. The procedures will be used by Aker to produce job cards, with the additional support from Naxys as required.

Naxys shall supervise the installation of equipment, and perform the installation when required. Necessary function tests are to be performed by Naxys. It is also Naxys responsibility to undergo the necessary HSE and AT/SJA courses needed for access at Nyhamna. Access to the courses is to be provided by Shell.

Naxys will have the responsibility to manage the data effectively. This shall include the processing and analysis of recorded data. As this will be done remotely, Naxys shall develop a contingency strategy to recover data in the event of a lost network connection.

The final responsibility of Naxys will be to report the results from testing at a scheduled basis, in a way suitable for Shell to base a review on.

Organization:

The organization of the project is described by the chart in figure 4. Communication will flow across the organization. The project manager will have to approve decisions concerning changes subject to change management procedures and economics. The delivery lead will report to both the project engineer and the project manager. The project manager will communicate with the Compression Pilot Team Manager.

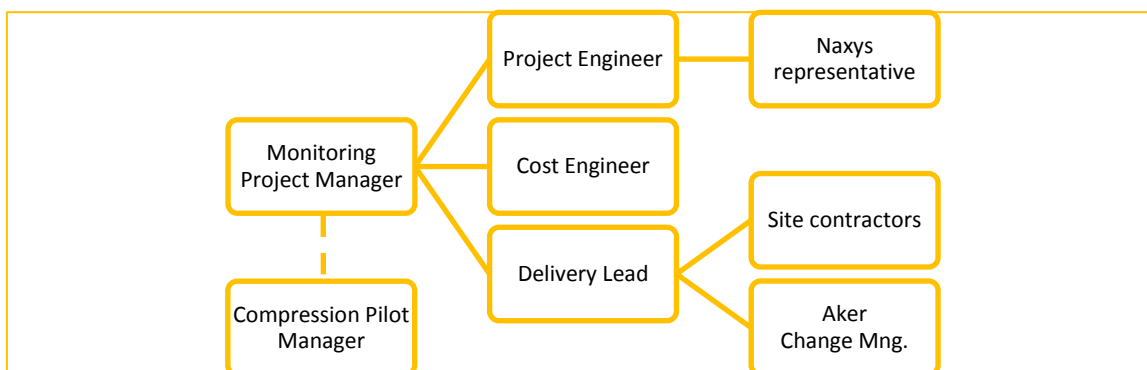



Figure 4: Organization chart for the project.

	A/S Norske Shell E&P Ormen Lange	
	Doc. No.	
	Page 8 of 10	
	Rev : 0	Rev. Date: 08.06.2011

5.0 Management of Change (MOC)

The purpose of the MOC process is to assure that any changes to facilities and projects (*in this case the compression pilot project & test site*) receive the technical review and necessary authorization *before* implementation, and to assure that the implementation is done in such a manner that any incidents involving people, environment, assets or reputation are avoided. To achieve this, all risks/hazards need to be identified, and plans for mitigation of these must be made. Changing involving the following are subjects to the MOC process:

- Alters in design/purpose of design
- Difference in approved key operational limits
- Changes in operational procedures which falls outside the design parameters.

For the remote acoustic monitoring project, no changes are to be executed without the approval of the project manager or delivery lead. All changes are required not to impact the Compression Pilot.

6.0 Budget

Budget details for the study are Shell proprietary information and are withheld in this version of the document.

7.0 Risks

The project is executed at low risk. The risk giving most concern for the project is the potential for impacting the Compression Pilot. The probability of this is considered to be minimal, but this cannot be assumed. Measures to assure that no impact occurs will have to be considered. The claim of low probability of impact is based on the monitoring equipment's remoteness to the target, as no interfaces will be required. A risk assessment will be carried out in fulfillment of project assurance requirements.

The monitoring equipment is lightweight, thus no heavy lifting is required. To prevent damage or interference with the Compression Pilot equipment, the monitoring equipment and cables will be fixed in the pit. Concrete weights will be added to the equipment to give stability, whereas cables will either follow existing cable trays or be weighed down by concrete. Given the method of fixing the cables, the number of lifts will be kept at a minimum. This is also achieved by using a workbasket for lifting several components at a

	A/S Norske Shell E&P Ormen Lange	
	Doc. No.	
	Page 9 of 10	
	Rev : 0	Rev. Date: 08.06.2011

time. As for components small/light enough to be held in one hand, these can be carried in to the pit.

There are no emissions to be expected from the sensing equipment. However, if hydrophones are damaged, there is a risk of spilling (oil type hydrophones). Hydrophones should be handled with care, and be protected against sharp edges, knives etc. In any case, the proper MSDS (Material Safety Data Sheet) should be at site with the equipment, and potential risk evaluated before installation. The required PPE (Personnel Protective Equipment) for entering the facility at Nyhamna will provide sufficient protection for the personnel.

There are two major risks to the project resulting from the system setup. The first is that the system will rely on a stable network connection. If connection is lost, valuable data will be lost in the process. This risk will be reduced by the development of a contingency strategy for the event of lost connection. The second major risk is that the signal integrity for transmitting analog signals through long cables is unknown. For the UEP array the risk is reduced by using a pre-amplifier before signal transmission. Each hydrophone contains a small, built-in amplifier, thus they do not need to be connected to an external amplifier in the pit.

8.0 HSE and Quality

HSE

A number of requirements and observations have been made to ensure that the HSE aspect is well looked after. Before personnel may enter the processing facility at Nyhamna, HSE and AT/SJA training is required. The HSE course defines the PPE required for personnel entering the test site. If oil leakage from a damaged hydrophone occur, this PPE is sufficient to protect the personnel, as the magnitude of the leak will be minimal. All personnel entering the test pit for installation work are required to participate in a specific "Pit Entry" course describing emergency routines and other regulations.

The monitoring equipment is lightweight, thus no heavy lifting is required. To mitigate damage to the Compression Pilot equipment, the monitoring equipment and cables will be fastened in the pit. The installation of the monitoring equipment is more or less straight forward. Regardless, installation procedures will be produced to ensure correct installation and that all aspects are covered. It is important to use personnel with the right skills and qualification for jobs like cable installation and lifting operations, as this will avoid faulty/incorrect installation and other incidents. Installation of the Macartney subsea cable will require working at height, when routing the cable from the junction box to the pit floor. For this work, the measures to be taken are described in the Nyhamna HSE requirements.

	A/S Norske Shell E&P Ormen Lange	
	Doc. No.	
	Page 10 of 10	
	Rev : 0	Rev. Date: 08.06.2011

Quality

The purpose of the quality management is to ensure that the project is in full compliance with all technical requirements, and that technical integrity is maintained and verified throughout the entire project. Here quality assurance is defined as a combination of the following three elements;

1. Project delivered at specifications
2. Project meeting the requirements and regulations
3. Project is value adding

The two first will be met through gathering of competence from different parts within the Shell organization such as technical authority and discipline engineers. Consultancy from Naxys and other contractors will also be used.

The project will add value through improved knowledge on the functional capabilities of the ALVD, with a view to enhancing the range of application. In addition it will yield the possibility to extend the monitoring function into performance and/or condition monitoring.