

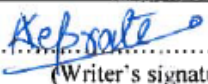

University of
Stavanger

Faculty of Science and Technology

MASTER'S THESIS

Study program/ Specialization: Offshore Technology, Marine & Subsea Technology	Spring semester, 2014 Open / Restricted access
Writer: Arvind Keprate	 (Writer's signature)
Faculty supervisor: Dr. Daniel Karunakaran, Ph.D. (University of Stavanger)	
External supervisor(s):	
Thesis title: Appraisal of Riser Concepts for FPSO in Deepwater	
Credits (ECTS): 30	
Key words: FPSO, Flexible Riser, SCR, SLWR, FSHR, HRT, SHR, BSR, Deepwater, Static, Dynamic, Fatigue	Pages: 173 + enclosure: 47 Stavanger, 30 th June 2014 Date/year

Front page for master thesis
Faculty of Science and Technology
Decision made by the Dean October 30th 2009

Abstract

With oil and gas reserves moving into deeper waters Floating Production Units (FPUs) have been widely used for production purpose. Selection of FPU for deepwater field development is a complicated task is mainly governed by factors like water depth, location of field (remoteness), environmental conditions, deck space requirements, storage requirements and offloading requirements etc. Amongst all the available FPU alternatives ship shaped FPSO has undoubtedly dominated the concept selection and are generally used in marginal and remote fields lacking pipeline infrastructure.

Selecting riser concept for FPSO stationed in deepwater has posed challenges due high hydrostatic pressure and large vessel payload. The condition is worsened if besides deepwater, FPSO is also stationed in harsh environmental conditions. Under such conditions FPSO is subjected to large offsets and dynamics which are directly transferred along the riser length to its base unless riser is uncoupled from the FPSO.

One of the major factors governing the riser concept selection for deepwater FPSO is the geographical location and weather conditions prevalent there. For example free hanging flexible riser has been mostly used in moderate environments of offshore Brazil while concepts like Steel Catenary Riser (SCR) and Hybrid Riser Tower (HRT) are dominant in calm weather conditions of West of Africa (WoA).

Flexible risers in various configurations are currently the most widely used concept with turret moored FPSO in water depth up to 1500m. This can be accounted to their flexibility which allows them to accommodate large vessel offsets and also to be spooled on reels/carrousel for storage and installation purposes. But other factors like requirement of large diameter to increase collapse resistance, tendency to birdcage, large cost and increased weight limits its use beyond 2000m.

For past decade on of the alternatives to flexible riser for spread moored FPSO in deepwater benign environments has been SCR. SCR is not only a cheaper option but also permits use of large diameter sizes as required to withstand high hydrostatic pressure at larger depths. However SCRs are yet to find its application with deepwater FPSO in moderate to harsh environments due to their reduced fatigue life at hang-off and Touch Down Zone (TDZ). One way of improving the fatigue life of SCR is by changing the riser configuration from catenary to wave shaped (SLWR) by adding buoyancy to it and such a configuration is installed with turret moored FPSO (1780m) in offshore Brazil.

Two overcome the disadvantage of coupled riser systems like SCR, un-coupled riser concepts namely Hybrid Riser Tower (HRT), Single Hybrid Riser (SHR) and Buoyancy Supported Riser (BSR) have been installed. Fairly new un-coupled riser concepts like Grouped Single Line Offset Riser (SLOR), Catenary Offset Buoyant Riser Assembly (COBRA) and Tethered Catenary Riser (TCR) are being studied and developed for deepwater application.

Till date there is no FPSO stationed in water depths exceeding 1000m in Norwegian Continental Shelf (NCS). Case study is performed at the end of thesis with the aim of recommending suitable riser concept which can be hooked to internal turret moored FPSO stationed in 1500m water depth and harsh environmental conditions of Northern Norwegian

Sea. Based on the literature review lazy wave configuration of flexible riser and Steel Lazy Wave Riser (SLWR) have been considered as a viable riser concept.

Main aim of this case study is to compare the two riser concepts on basis of vessel payload, fabrication cost and installation cost while the scope of study involves performing static, dynamic and fatigue analysis of both the riser systems by using Orcaflex. At the end of thesis an effort has been made to come up with suitable conclusions and recommendations based on the work done in this thesis.

Keywords: FPSO, Flexible Riser, SCR, SLWR, FSHR, HRT, SHR, BSR, Deepwater, Static, Dynamic, Fatigue

Acknowledgement

This thesis is part of the requirement to complete my MS degree in Marine and Subsea Technology, Faculty of Science and Technology, University of Stavanger. The writing process is carried out at Stavanger office of EMAS AMC AS since January 2014 and was completed in end of June 2014.

At the very outset I am highly grateful to my supervisor, Dr. Daniel Karunakaran, Ph.D. for his continuous support and encouragement which helped me in successful completion of this master thesis. I would like to thank him for disseminating valuable knowledge about risers which guided me throughout writing of the thesis. It was an honor working with him.

I would also like to owe my sincere gratitude to EMAS AMC AS and its employees Bjørn Stokka, Emmanuel Solomon and Odd H Knudsen for being so supportive. Many thanks to GE Wellstream and Hutchinson Engineering Group for providing me with valuable cost details used in the case study.

Next I would like to thank my classmates Adekunle Peter Orimolade and Mohammed Ali Mohammed for their valuable inputs and knowledge sharing which helped me in writing the thesis. Also thanks a lot to my friends in India Flt Lt. Kunal Sharma, Dr. Himang Jharaik, Er. Tushar Modgil, Er. Sachin Bhardwaj and Er. Nikhil Sharma for adding humor to my life. I wish all of you best of luck for the future. May all of you achieve great laurels in your life.

I would like to say many thanks to my cute nieces Prachi and Ashi, nephews Anshi and Panshul, sisters Neena, Disha and Sandeepa, brother-in-laws Ranjeet and Susheel, sister-in-law Sanjana, mother-in-law and father-in-law in India for being a source of motivation, love and encouragement to me.

Many thanks to my beautiful, understanding and supportive wife Shailja Keprate who always stood by me throughout this thesis work. Her smile, words and prayers were the source of encouragement for me. Thanks a lot for believing in me.

At last I owe everything and dedicate this thesis to my hardworking parents in India who held my hand during my first step as a kid and since then never left it. Thanks for making me what I am today.

Above all my sincere gratitude and love to Lord Shiva for blessing me and keeping me on right track.

I would like to write the wordings which have always motivated me:

*“You may be lucky enough to get SUCCESS once,
But holding on to it requires AIMED HARDWORK”*

Stavanger, 30th June 2014

Arvind Keprate

Nomenclature

Greek Characters

α_c	Parameter accounting for strain hardening and wall thinning
α_{fab}	Fabrication factor
γ_A	Accidental load effect factor
γ_c	Resistance factor to account for special conditions
γ_E	Environmental load effect factor
γ_F	Functional load effect factor
γ_m	Resistance factor for material and resistance uncertainties
γ_{SC}	Resistance factor for safety class
$\zeta(t)$	Periodic function of irregular wave
$\zeta_{a1/3}$	Significant wave amplitude
ζ_{an}	n wave amplitude
ν	Poisson's ratio
ρ	Water density
ρ_i	Density of the internal fluid
σ_ζ^2	Variance of the water surface elevation
ω_p	Angular spectral frequency
η	Usage factor
σ_e	Von Mises Equivalent Stress
$\sigma_1, \sigma_2, \sigma_3$	Principal Stress
σ_y	Material minimum yield strength

Symbols

A	Cross section area
A_i	Internal cross-sectional area
A_ω	Normalizing factor
CD	Drag coefficient
CA	Added mass coefficient
Ca	Allowable stress factor
Cf	Design case factor
D	Nominal outside diameter
D _{fat}	Accumulated fatigue damage (Palmgren-Miner rule)
f ₀	Initial ovality
f _n	Natural frequency
f _s	Vortex shedding frequencies
g	Acceleration of gravity
h	Height
H _{1/3}	Significant wave height (H _s)
k	Characteristic dimension of the roughness on the body

KC	Keulegan Carpenter number
kg	kilogram
kN	kilo Newton
m	meter
$m_0\zeta$	Area under the spectral curve
$m_1\zeta$	First order moment (static moment) of area under the spectral curve
$m_2\zeta$	Second order moment (moment of inertia) of under the spectral curve
MA	Bending moment from accidental loads.
ME	Bending moment from environmental loads
MF	Bending moment from functional loads
Mk	Plastic bending moment resistance
mm	millimeter
MN	Mega Newton
$m_n\zeta$	nth order moment under spectral density
MPa	Mega Pascal
pb	Burst resistance
pc	Resistance for external pressure (hoop buckling)
pd	Design pressure
pe	External pressure
pel	Elastic collapse pressure (instability) of a pipe
pi	Internal (local) pressure
pie	External (local) pressure
pinc	Incidental pressure
pld	Local internal design pressure, defined by
pli	Local incidental pressure
pmin	Minimum internal pressure
pp(t)	Plastic collapse pressure
ppr	Resistance against buckling propagation
Re	Reynolds number
Rk	Generalized resistance
s	Second
$S(\omega)$	Spectral Density
S0	Nominal stress range
SA	Load effect from accidental loads (vector or scalar)
SE	Load effect from environmental load (vector or scalar)
SF	Load effect from functional loads (vector or scalar)
SJ (ω)	JONSWAP spectrum
SP	Pressure loads
$S\zeta(\omega)$	Wave energy spectrum
t	time
t1	Minimum required wall thickness for a straight pipe without allowances
tcorr	Internal and external corrosion allowance
Te	tons

TeA	Effective tension from accidental loads
TeE	Effective tension from environmental loads
TeF	Effective tension from functional loads
tfab	Absolute value of the negative tolerance
Tk	Plastic axial force resistance
tnom	Nominal wall thickness
Tp	Wave peak period
Tw	True wall tension
Tz	Wave zero-crossing wave period

Abbreviations

ABS	American Bureau of Shipping
AISI	American Iron and Steel Institute
ALS	Accidental Limit State
API	American Petroleum Institute
ASTM	American Society for Testing and Materials
BSR	Buoyancy Supported Riser
CFA	Carbon Fibre Armor
CFC	Carbon Fibre Composite
COBRA	Catenary Offset Buoyant Riser Assembly
COR	Concrete Offset Riser
CP	Cathodic Protection
CRA	Corrosion Resistance Alloy
CVAR	Complaint Vertical Access Riser
DA	Dynamic Application
DFF	Design Fatigue Factor
DICAS	Differentiated Compliance Anchoring System
DNV	Det Norske Veritas
DOF	Degree of Freedom
DP	Dynamic Positioning
DSR	Deep Steep Riser
DTS	Distributed Temperature System
E&P	Exploration and Production
EWT	Extended Well Testing
FAT	Factory Acceptance Test
FE	Finite Element
FFRP	Flexible Fiber Reinforced Pipe
FLS	Fatigue Limit State
FPS	Floating Production System
FPSO	Floating Production Storage and Offloading
FPU	Floating Production Unit
FSFR	Free Standing Flexible Riser
FSHR	Free Standing Hybrid Riser

GoM	Gulf of Mexico
GOR	Gas Oil Ratio
HAT	Highest Astronomical Tide
HDPE	High Density Poly Ethylene
HIC	Hydrogen Induced Cracking
HP/HT	High Pressure/High Temperature
HRT	Hybrid Riser Tower
ID	Internal Diameter
IMA	International Maritime Associates
IPB	Integrated Production Bundle
ISO	International Organization for Standardization
JONSWAP	Joint Operation North Sea Wave Project
LAT	Lowest Astronomical Tide
LF	Low Frequency
LRA	Lower Riser Assembly
LRFD	Load and Resistance Factor Design
MBR	Minimum Bending Radius
NCS	Norwegian Continental Shelf
OCTG	Oil Country Tubular Goods
OD	Outer Diameter
OHTC	Overall Heat Transfer Coefficient
OTC	Offshore Technology Conference
PA	Poly Amide
PVDF	Polyvinylidene Fluoride
RAO	Response Amplitude Operator
SA	Static Application
SCF	Stress Concentration Factor
SCR	Steel Catenary Riser
SHR	Single Hybrid Riser
SLOR	Single Line Offset Riser
SLS	Serviceability Limit State
SLWR	Steel Lazy Wave Riser
SMYS	Specified Minimum Yield Stress
SPM	Single Point Mooring
SWR	Steep Wave Riser
T&C	Threaded and Coupled
TCR	Tethered Catenary Riser
TDP	Touch Down Point
TDZ	Touch Down Zone
TLP	Tension Leg Platform
TSJ	Tapered Stress Joint
TTR	Top Tensioned Riser
ULS	Ultimate Limit State

URA	Upper Riser Assembly
USD	United States Dollar
UTA	Upper Tendon Assembly
VIV	Vortex Induced Vibration
WD	Water Depth
WF	Wave Frequency
WSD	Working Stress Design

Table of Contents

Abstract	1
Acknowledgement	3
Nomenclature.....	4
List of Table	14
List of Figures	16
1. INTRODUCTION	19
1.1 Background	19
1.2 State of the art.....	20
1.3 Purpose and Scope	23
2. FLOATING PRODUCTION SYSTEM	25
2.1 Definition and Components.....	25
2.2 FPSO	27
2.2.1 General	27
2.2.2 Mooring System	27
2.2.3 Current Trend	29
2.2.4 Evolution and Future	31
2.2.5 Advantages.....	32
2.3 Discussion and Conclusion.....	33
3. RISER SYSTEM	34
3.1 Definition and Description	34
3.2 Riser System Design Consideration	35
3.3 Riser System Challenges	37
3.3.1 General	37
3.3.2 Deepwater Challenges	37
3.3.3 Harsh Environmental Challenges	38
3.3.4 Challenges Due to FPSO.....	40
3.4 Discussion and Conclusion.....	42
4. RISER CONCEPT IDENTIFICATION & ASSESMENT	43
4.1 Review	43
4.2 Identification & Assessment.....	43

4.2.1	Region Wise.....	44
4.2.2	Mooring Type	48
4.3	Discussion and Conclusion	50
5.	FLEXIBLE RISER.....	51
5.1	Definition and History.....	51
5.2	Configuration.....	53
5.2.1	Free Hanging Catenary.....	55
5.2.2	Lazy Wave	56
5.2.3	Pliant (Tethered) Wave.....	57
5.3	Construction.....	58
5.3.1	Bonded Metallic Pipe	58
5.3.2	Unbonded Metallic Pipe	59
5.3.3	Unbonded Hybrid Composite Pipe	64
5.3.4	Unbonded Nonmetallic Pipe.....	66
5.4	Components	67
5.4.1	End Fitting.....	67
5.4.2	Riser Hang-Off Structures	68
5.4.3	Bend Stiffener	68
5.4.4	Bend Restrictor	69
5.4.5	Riser Base.....	69
5.4.6	Connector	69
5.4.7	Other Components	70
5.5	Design	70
5.5.1	General.....	70
5.5.2	Failure Modes of Unbonded Metallic Flexible Riser System	72
5.5.3	Loads and Load Cases.....	75
5.5.4	Design Criteria	77
5.6	Current Trend & Future.....	79
5.7	Advantages and Limitations	85
5.7.1	Advantages.....	85
5.7.2	Limitations.....	86
5.8	Discussion & Conclusion	87

6.	RIGID METALLIC RISER.....	88
6.1	Definition and History.....	88
6.2	Configuration.....	88
6.2.1	Steel Catenary Riser (SCR)	89
6.2.2	Steel Lazy Wave Riser (SLWR).....	89
6.2.3	Weight Distributed SCR.....	89
6.3	Components	91
6.3.1	Riser Pipe.....	91
6.3.2	Flex joint.....	92
6.4	Design	94
6.4.1	WSD Methodology - API-RP-2RD	94
6.4.2	LRFD Methodology – DnV-OS-F201	96
6.5	Current Trend & Future.....	102
6.6	Advantages & Limitations	104
6.6.1	Advantages.....	104
6.6.2	Limitations.....	105
6.7	Discussion & Conclusion	106
7	HYBRID RISER	107
7.1	Definition and History.....	107
7.2	Configuration.....	108
7.2.1	1st Generation Hybrid Riser	108
7.2.2	2 nd Generation Hybrid Riser	109
7.2.3	3 rd Generation Hybrid Riser.....	110
7.2.4	Buoyancy Supported Riser	112
7.3	Components	113
7.3.1	Foundation	113
7.3.2	Base Assembly	115
7.3.3	Riser Strings	116
7.3.4	Buoyancy Tank	116
7.3.5	Upper Riser Assembly/ Gooseneck Assembly.....	117
7.3.6	Flexible Jumper	118

7.4	Design	118
7.5	Current Trend & Future.....	119
7.6	Advantages & Limitations	125
7.6.1	Advantages.....	125
7.6.2	Limitations	126
7.7	Discussion & Conclusion	126
8	CASE STUDY	127
8.1	Purpose and Scope	127
8.2	Analysis Methodology.....	127
8.2.1	General	127
8.2.2	Waves	128
8.2.3	Wave Energy Spectrum	129
8.2.4	Current	130
8.2.5	FPSO Motions	131
8.2.6	Response Amplitude Operator (RAO)	132
8.2.7	Hydrodynamic Coefficients	132
8.2.8	Global Analysis	134
8.2.9	Time Domain Fatigue Analysis	136
8.3	System Overview.....	137
8.4	Environmental Condition	138
8.5	Vessel Data.....	139
8.6	Riser Properties	140
8.7	Static Analysis	142
8.7.1	Steel Lazy Wave Riser.....	142
8.7.2	Lazy Wave Flexible Riser.....	145
8.8	Dynamic Analysis	147
8.8.1	Steel Lazy Wave Riser.....	147
8.8.2	Lazy Wave Flexible Riser.....	149
8.9	Fatigue Analysis	150
8.9.1	General	150
8.9.2	SLWR Fatigue Parameter.....	151
8.9.3	SLWR Fatigue Result- First Order Wave Effect.....	152
8.9.4	SLWR Fatigue - VIV.....	155

8.9.5	Flexible Riser Fatigue	156
8.10	Comparison	159
8.10.1	General	159
8.10.2	Vessel Payload.....	159
8.10.3	Cost	160
8.10.4	Recommendation.....	163
8.11	Discussion and Conclusion	163
9	CONCLUSION & RECOMMENDATION	164
9.1	Conclusion	164
9.2	Recommendation	165
10	REFERENCE	167
10.1	Literature Reference.....	167
10.2	Internet Reference.....	172
	APPENDIX A – Worldwide Deepwater FPSO Riser Concept	174
	APPENDIX B – Wave Spectrum Models & Cost Details	177
	APPENDIX C – Detailed Analysis Result.....	181
	APPENDIX D – Orcaflex Software Description	214

List of Table

Table 1.1 - Worldwide Deepwater Projects with FPSO and their Riser Concepts	22
Table 2.1 – Spread Moored vs Turret Moored FPSO	28
Table 2.2 - Phases of Deepwater FPSO in Offshore Brazil [Brandao & Henriques, 2007].....	31
Table 3.1 - Region Specific Environmental Conditions	39
Table 3.2 - Typical Deepwater FPU Natural Periods [DNV-RP-F205, 2010]	40
Table 4.1 - Number of Worldwide Deepwater FPSOs with their Riser Concepts.....	44
Table 4.2 - Number of Deepwater FPSOs with their Riser Concepts in Various Locations	47
Table 4.3 - Number of Worldwide Deepwater FPSOs with their Riser Concepts and Mooring Type	48
Table 4.4 - Comparison of Riser Concepts for Spread Moored FPSO [Marcoux and Legras, 2014].....	48
Table 4.5 - Comparison of Riser Concepts for Turret Moored FPSO [Marcoux and Legras, 2014].....	49
Table 5.1 - Historical Milestones of Flexible Pipe.....	51
Table 5.2 - Classification of Standard Unbonded Flexible Pipe [API RP 17B, 2008].....	59
Table 5.3 - Characteristics of Typical Carcass Materials [Palmer and King, 2004]	61
Table 5.4 - Characteristics of Typical Inner Pressure Sheath Materials [Palmer and King, 2004]	62
Table 5.5 - Comparison of Various Materials Used for Making Tensile Armor [Do & Lambert, 2012]...64	
Table 5.6 - Failure Modes for Structural Design of Unbonded Flexible Pipe [API RP 17B, 2008].....	73
Table 5.7 - List of Failure Modes of Components of Riser System [API RP 17B, 2008].....	75
Table 5.8 - Recommendations on Annual Probabilities of Occurrence for 20 Year Service Life	76
Table 5.9 - Example of Load Case Matrix for FPSO Application	76
Table 5.10 - Flexible Pipe Layer Design Criteria [API Specification 17J, 2008]	77
Table 5.11 - Flexible Pipe Layer Design Criteria [API RP 17B, 2008]	79
Table 5.12 – Comparison of Competitors in Unbonded Flexible Pipe Market.....	79
Table 5.13 – Technology Status of Unbonded Flexible Risers in terms of Max. WD	80
Table 5.14 – Technology Status of Unbonded Flexible Risers in terms of Max Allowable Pressure.....	81
Table 5.15 – Technology Status of Unbonded Flexible Risers in terms of Max. ID	82
Table 6.1 – Historical Milestones of Steel Riser	88
Table 6.2 – Comparison of TSJ vs Flex Joint.....	93
Table 6.3 – Usage Factors of WSD format [API-RP-2RD, 1998]	95
Table 6.4 – Load Effect Factors [DNV-OS-F201, 2010]	96
Table 6.5 – Safety Class Classification [DNV-OS-F201, 2010].....	96
Table 6.6 – Safety Class Resistance Factor [DNV-OS-F201, 2010].....	97
Table 6.7 – Material Resistance Factor [DNV-OS-F201, 2010]	97
Table 6.8 – Design Fatigue Factor [DNV-OS-F201, 2010]	100
Table 6.9 – Simplified Design Check for Accidental Loads [DNV-OS-F201, 2010]	101
Table 6.10 – Example of SLS for Production Risers with Surface Tree [DNV-OS-F201, 2010].....	101
Table 6.11 – Material/Configuration Combination Studied in RPSEA Project [Royer et al, 2013]	104
Table 7.1 – Historical Milestones of Hybrid Riser	107
Table 7.2 – Industry Specification for FSHR [Sworn, 2005]	118
Table 8.1 - Offshore Regions and their Wave Spectrum.....	130

Table 8.2 – Surface Roughness [DNV-RP-C205, 2010]	133
Table 8.3 – Typical Analysis Technique and its Application [DNV-OS-F201, 2010]	135
Table 8.4 – Wave Data [Karunakaran & Baarholm, 2013]	138
Table 8.5 – Current Data [Karunakaran & Baarholm, 2013]	139
Table 8.6 – Hydrodynamic Coefficients [Karunakaran & Baarholm, 2013].....	139
Table 8.7 – Soil Properties [Karunakaran & Baarholm, 2013].....	139
Table 8.8 – Vessel Offset Data	140
Table 8.9 – Steel Riser Properties [Karunakaran & Baarholm, 2013].....	140
Table 8.10 – Properties of Buoyancy Module for SLWR.....	141
Table 8.11 – Flexible Riser Properties	141
Table 8.12 – End Fitting Properties.....	141
Table 8.13 – Bend Stiffener Properties	142
Table 8.14 – Properties of Buoyancy Module for Lazy Wave Flexible Riser	142
Table 8.15 – Load Cases	142
Table 8.16 – SLWR Static Analysis Result.....	144
Table 8.17 – Lazy Wave Flexible Riser Static Analysis Result	146
Table 8.18 – SLWR Dynamic Analysis Result	148
Table 8.19 – Lazy Wave Flexible Riser Dynamic Analysis Result.....	150
Table 8.20 – Minimum Fatigue Life at Various Locations of SLWR	152
Table 8.21 – Fatigue Analysis Scheme [Dhaigude and Sharma, 2104]	159
Tabell 0.1 - Worldwide Riser Concepts with Deepwater FPSO [Offshore Magazine, August 2013]	176

List of Figures

Figure 1.1 – FPU Types for Deepwater Field Development [Offshore Magazine, May 2013]	19
Figure 1.2 - Trend in Water Depth for Offshore Production [Offshore Magazine, May 2013]	20
Figure 2.1 - General Schematic of Floating Production System (FPS)	25
Figure 2.2 - Deepwater Floater Options	26
Figure 2.3 - Internal & External Turret Mooring System for FPSO [National Oilwell Varco, 2013]	28
Figure 2.4 - FPU's percentage distribution for year 2010 [Oil & Gas Journal, 2010]	29
Figure 2.5 - Worldwide Distribution of FPSO Vessel [Offshore Magazine, August 2013]	29
Figure 2.6 - FPSO in Deepwater (>600m) at Various Location	30
Figure 2.7 - Forecast of FPU's percentage distribution for 2012-2016 [E&P Magazine, 2011]	32
Figure 3.1 - Elements of FPS Riser System [Balmoral Offshore Engineering Catalogue, 2012]	34
Figure 3.2 - Deepwater Challenges on Riser	38
Figure 3.3 - Region Specific Environmental Challenges	39
Figure 3.4 - Natural Period of Floaters vs Wave Period [Uppu, 2012]	41
Figure 4.1 - Installed Riser Concepts with FPSO in Deepwater	43
Figure 4.2 - Number of Deepwater FPSOs with their Riser Concepts in Offshore Brazil	45
Figure 4.3 - Number of Deepwater FPSOs with their Riser Concepts in Offshore Nigeria	46
Figure 4.4 - Number of Deepwater FPSOs with their Riser Concepts in Offshore Angola	47
Figure 4.5 - Number of Spread Moored FPSO with its Riser Concepts (Worldwide)	49
Figure 4.6 - Number of Turret Moored FPSO with its Riser Concepts (Worldwide)	50
Figure 5.1 - Year vs Number of Flexibles Installed [Offshore Magazine, November 2010]	52
Figure 5.2 - Cumulative Number of Flexible Risers Installed in NCS [4Subsea, 2013]	53
Figure 5.3 - Flexible Riser Complaint Configurations [Offshore Magazine, November 2010]	54
Figure 5.4 - Free Hanging Riser Configuration	55
Figure 5.5 - Lazy Wave Riser Configuration	56
Figure 5.6 - Pliant Wave Riser Configuration	57
Figure 5.7- Cross-section of Bonded Flexible Riser [Antal et al, 2003]	58
Figure 5.8 - Cross-section of Coupling Used with Bonded Flexible Riser [Antal et al, 2003]	58
Figure 5.9 - Cross-section of Family of Unbonded Flexible Riser [NKT Flexibles Boucher, 2012]	59
Figure 5.10 - Cross-section of Family III Flexible Riser [NKT Flexibles Boucher, 2012]	60
Figure 5.11 - Structure of Conventional Carcass and K-Profile Carcass [Nielsen et al, 2011]	61
Figure 5.12 - Typical Pressure Armor Profiles Used in Unbonded Flexible Pipe [API RP 17B, 2008]	62
Figure 5.13 - Typical CP System of Flexible Pipe [Palmer and King, 2004]	63
Figure 5.14 - Specific Strength of Materials Used for Making Tensile Armor [Do & Lambert, 2012]	64
Figure 5.15 - Comparison of Typical Cross-section of Flexible Riser [Bernard et al, 2013]	65
Figure 5.16 - Typical Cross-section of Flexible Fiber Reinforced Pipe [Bryant et al, 2007]	66
Figure 5.17 – Typical Topside End Termination of Flexible Riser [NOV, 2013]	67
Figure 5.18 - Cross-section of Typical End Fitting [NOV, 2013]	67
Figure 5.19 – Typical Bend Stiffener [BMP, 2013]	68
Figure 5.20 – Typical Bend Restrictor [BMP, 2013]	69

Figure 5.21 – Typical Riser Base Structure [Offshore Energy Today, 2012].....	69
Figure 5.22 – Distributed Buoyancy Modules [Trelleborg Brochure, 2013]	70
Figure 5.23 – Water Depth Capability of Unbonded Flexible Risers [Offshore Magazine, Nov 2010].....	80
Figure 5.24 – Internal Pressure Capability of Flexible Risers [Offshore Magazine, Nov 2010]	81
Figure 5.25 – Cross-Section of IPB Riser used in Dalia field [Technip Brochure, 2013].....	83
Figure 5.26 – Free Standing Flexible Riser System Overview [Lupi et al, 2014].....	84
Figure 6.1 – Weight Distributed SCR [Karunakaran et al, 2005].....	90
Figure 6.2 – Weight Distributed SCR using Clump Weight [Foyt et al, 2007]	90
Figure 6.3 – Main Steps of the Hydroforming Process [BUTTING Catalogue, 2008].....	91
Figure 6.4 – Mechanically Lined BuBi® Pipe [BUTTING Catalogue, 2008]	92
Figure 6.5 – Flex Joint and its Flexible Element [Hutchinson Catalogue, 2010].....	93
Figure 6.6 – Different Variants of Flex Joint [Hutchinson Catalogue, 2010].....	94
Figure 6.7 – Water Depth Capabilities of Steel Risers with Years of Starting Operation.....	102
Figure 6.8 – Compliant Vertical Access Riser Concept [Martins et al, 2012].....	103
Figure 7.1 – Bundled Hybrid Riser in Grand Banks Block 388 [Tellier & Thethi, 2009]	108
Figure 7.2 – Girassol HRT field arrangement [Subsea 7, 2013].....	109
Figure 7.3 – Cross section of 2 nd Generation HRT and Foam Modules [Rouillon, 2002].....	110
Figure 7.4 – 2 nd and 3 rd Generation HRT [Tellier & Thethi, 2009].....	110
Figure 7.5 – SHRs Installed with External Turret FPSO [Tellier & Thethi, 2009]	111
Figure 7.6 – Cross-section of SHRs used in Kizomba A & Kizomba B [Tellier & Thethi, 2009].....	112
Figure 7.7 – BSR Arrangement and its Subsurface Buoy [Subsea 7, 2013].....	112
Figure 7.8 – Typical SHR arrangement and its Components [Eyles & Lim, 2006].....	113
Figure 7.9 – Typical SHR Foundation Arrangement & its Flexible Joint [Eyles & Lim, 2006].....	114
Figure 7.10 – Typical Lower Riser Assembly of SHR [Eyles & Lim, 2006]	114
Figure 7.11 – Base Assembly of SHR [Eyles & Lim, 2006]	115
Figure 7.12 – Jumper Offtake Position Relative to Buoyancy Tank [Tellier & Thethi, 2009].....	116
Figure 7.13 – Different Types of Buoyancy Tank [Subsea 7, 2013]	117
Figure 7.14 – Different Types of Buoyancy Tank [Subsea 7, 2013]	118
Figure 7.15 – Water Depth Capabilities of Hybrid Riser with Years of Starting Operation	120
Figure 7.16 – Grouped SLOR vs SLOR Field Layout & Jumper Tieback [Subsea 7, 2013]	120
Figure 7.17 – Grouped SLOR Top Arrangement [Karunakaran et al, 2007].....	121
Figure 7.18 – Typical COBRA Riser Arrangement [Karunakaran and Baarholm, 2013].....	122
Figure 7.19 – Schematic of Subsurface Buoy of TCR [Legras, 2013]	123
Figure 7.20 – Deep Steep Riser Arrangement, 3D Artistic View [Lupi et al, 2014]	124
Figure 8.1 - Regular Wave Profiles [Chakrabarti, 2005].....	128
Figure 8.2 - Time Histories and Associated Spectral Shapes [Chakrabarti, 2005]	128
Figure 8.3 - Time History of Random Wave	129
Figure 8.4 – Wave Spectrum.....	129
Figure 8.5 – FPSO Motions in Sea [AT-Marine Oy, 2010].....	131
Figure 8.6 – Relationship between FPSO Motions and Waves [Journee and Massie, 2001].....	131
Figure 8.7 – Drag Coefficients for Fixed Circular Cylinder for Steady Flow [DNV-RP-C205, 2010].....	133
Figure 8.8 – Added Mass Coefficient as Function of Kc for Cylinder [DNV-RP-C205, 2010].....	133
Figure 8.9 – Effective Weight and Tension [Barltrop, 1998]	134

Figure 8.10 – S-N Curves in Seawater with Cathodic Protection [DNV-RP-C203, 2010]	137
Figure 8.11 – Lazy Wave Riser Configuration Used in Case Study	138
Figure 8.12 – SLWR Riser Configuration for Static Analysis	143
Figure 8.13 – SLWR Effective Tension for Static Analysis	143
Figure 8.14 – SLWR Bending Moment for Static Analysis	144
Figure 8.15 – Lazy Wave Flexible Riser Configuration for Static Analysis.....	145
Figure 8.16 – Lazy Wave Flexible Riser Effective Tension for Static Analysis.....	145
Figure 8.17 – Lazy Wave Flexible Riser Normalized Curvature for Static Analysis.....	146
Figure 8.18 – Wave Profile for 3 Hours.....	147
Figure 8.19 – SLWR Effective Tension for Dynamic Analysis	147
Figure 8.20 – SLWR LRFD Utilization for Dynamic Analysis	148
Figure 8.21 – Lazy Wave Flexible Riser Effective Tension for Dynamic Analysis	149
Figure 8.22 – Lazy Wave Flexible Riser Curvature for Dynamic Analysis	149
Figure 8.23 – Representative Sea State for Fatigue Analysis.....	151
Figure 8.24 – Fatigue Wave Probability per Direction	151
Figure 8.25 – Minimum Fatigue Life of Steel Lazy Wave Riser for Various Wave Directions.....	152
Figure 8.26 – Fatigue Life of Steel Lazy Wave Riser near Hang - Off Location	153
Figure 8.27 – Fatigue Life of Steel Lazy Wave Riser in Sag Bend Region	153
Figure 8.28 – Fatigue Life of Steel Lazy Wave Riser in Hog Bend Region.....	154
Figure 8.29 – Fatigue Life of Steel Lazy Wave Riser near TDP.....	154
Figure 8.30 – Cross Flow and Inline Flow Vibration [Bai & Bai, 2005]	155
Figure 8.31 – Deepwater Riser Subjected to VIV	155
Figure 8.32 – Slipping of Helical Armors during Bending of Flexible Pipe [Skeie et al, 2012]	156
Figure 8.33 – Critical Hotspots and Helix Position for Fatigue Analysis [Skeie et al, 2012].....	157
Figure 8.34 – Response Models for Cross-Sectional Analysis [Dhaigude and Sharma, 2104]	158
Figure 8.35 – Comparison of Vessel Payload for Single Lazy Wave Flexible Riser & SLWR	160
Figure 8.36 – Comparison of Fabrication Cost for Single Lazy Wave Flexible Riser & SLWR.....	161
Figure 8.37 – Comparison of Installation Cost for Single Lazy Wave Flexible Riser & SLWR.....	162
Figure 8.38 – Comparison of Total Cost for Single Lazy Wave Flexible Riser & SLWR	162

1. INTRODUCTION

1.1 Background

Offshore oil and gas industry marked its beginning in late 1940s and at that time the wells were consistently tied back to fixed platforms. However with the exploration moving to deep and remote areas the use of fixed platforms became impractical because of techno-commercial reasons, which marked an era of Floating Production Systems (FPS).

World's first floating platform was a semi-submersible deployed in 1975 on the Argyll field located in UK sector of the North Sea. Two years later, the first oil Floating Production Storage and Offloading (FPSO) was stationed at 117m water depth in Shell's Castellon field, and then few years later Tension Leg Platform (TLP) and Spar platforms joined the fleet of Floating Production Unit (FPU) [Offshore Technology, 2008]. As the time progressed continuous advancements took place in the FPU sector and today different types of FPUs are being used for deepwater field development as shown in Figure 1.1.

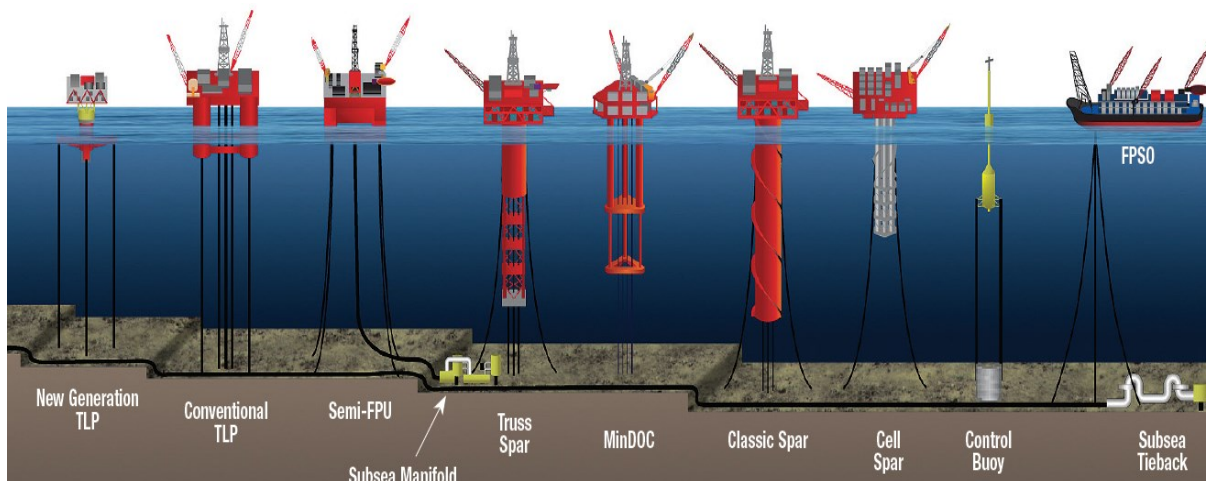

Figure 1.1 – FPU Types for Deepwater Field Development [Offshore Magazine, May 2013]

Note: Cylindrical FPSO (Sevan) has also joined the FPU fleet.

Selection of FPU for deepwater field development is a complicated act as it is mainly governed by factors like water depth, location of field (remoteness), environmental conditions, deck space requirements, storage requirements and offloading requirements etc. Keeping all these factors in mind the most favorable FPU alternative for deepwater fields located in remote and harsh climatic areas is undoubtedly the ship shaped FPSO.

Designing risers for FPSO in deepwater has posed a serious challenge due to the high hydrostatic pressures and huge vessel payloads. The most common riser concepts for deepwater benign environments are free hanging flexible riser, Steel Catenary Riser (SCR) and Hybrid Riser Tower (HRT) [Karunakaran et al, 1996].

The condition is exacerbated for deepwater FPSO stationed in moderate to harsh environments. This is due to its large offset and high dynamic response which renders concepts like Top Tensioned Risers (TTRs), free hanging flexible riser and SCRs non practical. To cope up with this situation offshore industry has focused on concepts like lazy wave flexible riser, Steel Lazy Wave Riser (SLWR), Single Hybrid Riser (SHR) and Buoyancy Supported Riser (BSR) [Marcoux and Legras, 2014].

1.2 State of the art

In the year 2000 total oil production from offshore accounted for 22% of global production 1% of which came from deep water. In 2010, these figures had surged to 33% and 7%, respectively and by 2015 the latter is expected to reach 11% [E&P Magazine, 2011]. Also the average depth of installing subsea wells has seen a tremendous increase from about 200m in early 90s to about 1000m today [Saipem Brochure, 2013]. Hence in terms of water depth the offshore industry has continuously reached to new frontiers since its inception as can be seen from Figure 1.2.

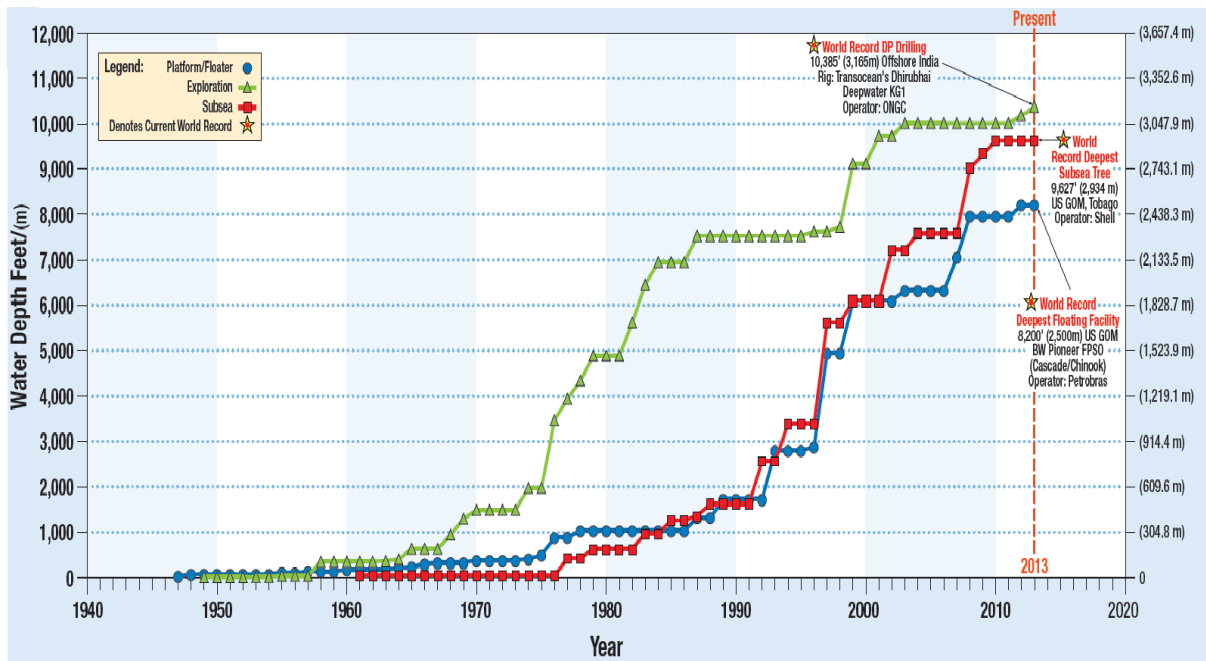

Figure 1.2 - Trend in Water Depth for Offshore Production [Offshore Magazine, May 2013]

As of now the deepest floating facility is BW Pioneer FPSO which is stationed at 2500m water depth in US Gulf of Mexico (GoM). Though this is the first and only FPSO in this area till now (Shell is planning to install deepest FPSO at 2900m for Stones field in US GoM), but in other deepwater oil producing countries like Angola, Brazil and Nigeria FPSOs are the preferred floater units. Most of the deepwater FPSOs used in Angola and Nigeria are spread moored due to the benign environmental conditions prevailing in the region. However offshore Brazil is characterized by moderate and directional environment for which turret moored FPSOs are the obvious choice.

The environmental conditions not only decide the mooring type of FPSO but it also plays a significant role in riser concept selection. For example in deepwater the coupled riser concept like free hanging flexible riser is mostly suited for calm to moderate weather conditions, however moderate to harsh weather conditions demand the use of SLWR and uncoupled riser concepts like SHR and BSR.

World's first dynamic riser was a flexible pipe which was used with semi-sub at 120m on Enchova field in 1977 [Fraga et al, 2003]. Later on flexible risers were used with FPSOs and currently are the most widely used concept with turret moored FPSO in water depth up to 1500m. This can be accounted to their flexibility which allows flexible riser to accommodate large vessel offsets and also to be spooled on reels/carrousel for storage and installation purposes. Being a proved technology and ability to re-use them is an added advantage.

But other factors like requirement of large diameter to increase collapse resistance, tendency to birdcage, large cost and high vessel payload its use beyond 2000m. To overcome these disadvantages use of unbonded hybrid composite riser and unbonded non-metallic riser seems to be one of the alternatives for deep and ultra- deep water because of their high strength to weight ratio and anti-corrosive properties. Also to meet the thermal requirements for better flow assurance of certain projects like Dalia and Pazflor, Integrated Production Bundle (IPB) are being used [Technip Brochure, 2013].

For past decade one of the alternatives to flexible riser for spread moored FPSO in deepwater benign environments has been SCR. SCR is not only a cheaper option but also permits usage of large diameter sizes as required to withstand high hydrostatic pressure at larger depths. Though SCR was first installed in 1994 with Auger TLP but its first application with FPSO (1000m water depth) was in year 2004 for Shell's Bonga field in Nigeria. Since then only two more SCRs have been installed with FPSO in Erha and AKPO fields both of which are again in offshore Nigeria.

However SCRs are yet to find its application with deepwater FPSO in moderate environments (offshore Brazil) and harsh environments (US GoM & Norwegian Sea). The reason for this can be accounted to SCR's deteriorated performance due to extensive dynamic motions of the FPSO which causes enormous bending and cyclic stress at hang off area and TDZ of SCR thereby resulting in its fatigue damage and reduced life.

One way of improving the fatigue life of SCR particularly in moderate and harsh environments is to separate FPSO invoked motions from TDZ of the riser. This is achieved by changing the riser configuration from catenary to wave shaped (SLWR) by adding buoyancy to it. The first and only SLWR till now was installed in 2009 for Shell's BC-10 field with turret moored FPSO stationed at 1780 m water depth in offshore Brazil. Shell is also planning to install the same riser concept in the Stones field with FPSO stationed at 2900m in US GoM. This will be the world's deepest stationed FPSO once it is on site [Marcoux and Legras, 2014].

According to research done by Petrobras "Steel Lazy Wave Riser (SLWR) is the most adequate configuration for the bow turret-moored FPSO's in deep water due to its structural behavior and costs when compared to other configurations" [Saliés, 2003]. However it suffers from some disadvantages like high vessel payload (though less than flexible & SCR), requirement of high quality welds, sophisticated weld testing techniques, high cost and complex installation due buoyancy modules etc.

To overcome the disadvantage of coupled riser systems fairly new un-coupled riser concepts namely Free Standing Hybrid Riser (FSHR) and Buoyancy Supported Riser (BSR) have been developed. Both of these concepts are particularly suited for deepwater in almost any kind of environment and they offer following enhancement when compared to coupled risers:

- Reduced payload on the FPSO.
- Less TDP movement hence better fatigue performance which means weld requirements are not so stringent.
- Ability to construct and install in the field prior to FPSO arrival.

First hybrid riser had bundled tower arrangement (HRT) which was installed in 1988 in Grand Canyon Block 29 (US GoM). It was hooked up to a semi-sub stationed at 460m and was later on decommissioned, refurbished and re installed in Gardens Bank 388 (US GoM)

with a semi-sub in 1994. Its first use with a FPSO was in 2001 for Girassol field (1400m) offshore Angola. This configuration was then installed in 2007 for two separate projects namely Rosa and Greater Plutonio, with spread moored FPSO in offshore Angola.

HRT generally consists of a single vertical tower encapsulating export production, gas lift, water injection and service risers. The vertical tower has a layer of syntactic foam buoyancy which helps it to stand perpendicularly on seafloor. An alternate FSHR arrangement is Single Hybrid Riser (SHR) which unlike bundle HRT utilizes a single steel riser to transport well fluids from the seabed to the FPU thereby mitigating the risk of failure of entire riser in case structural core fails. This configuration was first used with FPSO Kizomba A in 2004 at 1180m water depth, offshore Angola and since then has been used in FPSOs Kizomba B (Angola), PSVM (Angola), Usan (Nigeria) and BW Pioneer (US GoM) in depths ranging from 850m to 2500m [Offshore Magazine, August 2013].

Besides lowering the vessel payloads and improving the fatigue life FSHR comes with an added advantage of smaller subsea footprint and ability to pre install them therefore improving the project schedule. However it is an expensive and difficult to design solution as it requires a number of complicated bottom assemblies and components which limits its use as a preferable concept [Karunakaran and Baarholm, 2013].

The latest addition to hybrid riser family is Buoyancy Supported Riser (BSR) concept which is patented by Petrobras and was developed by Subsea 7 for pre salt fields of Santos Basin where water depth exceeds 2100m. It has been successfully installed since 2012 in Guara Sapinhua and Lula NE pre salt fields in offshore Brazil and consists of a large sub-surface buoy anchored to the seabed by eight tethers, two on each corner of the buoy [Subsea 7, 2013]. The buoy acts as an interface to the SCR coming from seabed and flexible jumper connected to the FPSO, which absorbs the host vessel motions thereby reducing TDP motion of SCR. This concept offers additional advantage over FSHR as it does not require heavy assemblies and foundations which are complex to design and difficult to install.

A summary of deepwater FPSOs along with the riser concept is given below in Table 1.1.

Field Name	Field Operator	Region	Water Depth (m)	FPSO Mooring	Riser Concept
Marlim	Petrobras	Brazil	780	Internal Turret	Free Hanging Flexible Riser
Block 17-Acacia,	Total	Angola	780	Spread	Lazy wave Flexible Riser-IPB
Bonga	Shell	Nigeria	1000	Spread	Steel Catenary Riser
MA-D6	Reliance Industries Limited	India	1200	Internal Turret	Pliant Wave Flexible Riser
Girrasol & Rosa	Total	Angola	1400	Spread	Hybrid Riser Tower
Agbami OPL 216,217	Nigerian National Oil Corporation	Nigeria	1462	Spread	Free Hanging Flexible Riser
BC-10	Shell	Brazil	1780	Internal Turret	Steel Lazy Wave Riser
Guara Sapinhua	Petrobras	Brazil	2100	Spread	Buoyancy Supported Riser
Cascade & Chinook	Petrobras America	US GoM	2500	Internal Turret	Single Hybrid Riser

Table 1.1 - Worldwide Deepwater Projects with FPSO and their Riser Concepts

Most of the aforementioned riser concepts are being constantly reviewed and continuous research is going to improve their performance and design. For e.g. Tethered Catenary Riser (TCR) a novel riser concept is an improved version of already field proven BSR. TCR whose components are almost similar to BSR uses a buoy which is tethered by a single pipe tendon anchored by suction pile to the seabed [Legras, 2013]. Hence it has edge over BSR in terms of simpler tethering mechanism along with easier installation method.

Another new un-coupled riser concept called as Catenary Offset Buoyant Riser Assembly (COBRA) is the improved variant of “Catenary Bundle Riser” which was developed by Subsea 7 in early 2000. COBRA consists of a catenary riser section with a long, slender buoyancy module on top which is tethered down to seabed [Karunakaran and Baarholm, 2013]. Both TCR and COBRA which are yet to be field proven are apt for FPSO in deepwater harsh environment and offer all the benefits of an un-coupled riser system. In addition both concepts allow larger step-out distance between FPSO and subsea well which makes them a promising concept for deepwater harsh environments [Karunakaran and Baarholm, 2013].

The latest evolution in the riser family suitable for deep and ultra-deep water is Free Standing Flexible Riser (FSFR) which is similar to Free Standing Hybrid Riser (FSHR) except that the vertical section of riser which is a rigid pipe in case of FSHR is replaced by a flexible pipe due to its ease of installation and reduced top assembly requirements [Lupi et al, 2014]. Also a research program for RPSEA project was started in August 2012 in which various riser concepts for vessels with high dynamic response (Semi-Sub & FPSO) in ultra-deep water are being compared. The study is expected to be completed in August 2015 and the results of study will be interesting to see [Royer et al, 2013]

1.3 Purpose and Scope

Before defining the goals and scope of thesis it is important to define the word deepwater as different standards have different range of water depths which implies to term deepwater. For example according to API RP 17A deep water is considered generally ranging from 610m (2000 ft) to 1830m (6000 ft), while according to NORSOK D-001 (REV 3) the range varies from 600m to 3000m. However for this thesis the definition of deepwater as given in NORSOK D-001 (REV 3) will be considered. The main goals of this thesis are:

- To identify the riser concepts which are installed till date with FPSO in deepwater.
- To assess the identified riser concepts on features like configuration, construction, strength, dynamic performance, design etc.
- To discuss current trend. Future of riser concepts and to identify gaps in technology which hinder the application of few riser concepts in deepwater.
- To recommend the most feasible riser concept for disconnectable turret moored FPSO in deepwater and harsh environments of Northern Norwegian Sea.

The thesis will be carried under the limelight of the various challenges faced by riser system design due to deepwater and harsh environments. The main scope of the thesis includes:

- Literature review of the riser concepts installed and feasible with FPSO in deepwater.
- Perform case study which involves doing static, dynamic and fatigue analysis of the feasible riser concepts hooked to internal turret moored FPSO located at 1500m water depth in harsh environmental conditions of Northern Norwegian Sea.
- Case study further involves comparing the riser concepts on parameters like vessel payload, fabrication cost and installation cost.
- Suitable conclusions and recommendations will be made at the end of thesis.

The structure of the thesis is presented below in tabular form:

Ch 1. Introduction
<ul style="list-style-type: none"> • Gives a brief view of background and state of the art in the field of deepwater riser concepts for FPSO. Also includes the problem statement, purpose and scope of the thesis work.
Ch 2. Floating Production System
<ul style="list-style-type: none"> • It discusses the components of floating production system and various types of floater units. It also discusses the current trend, evolution and future of FPSOs worldwide. Finally the advantages offered by FPSO have been listed.
Ch 3. Riser System
<ul style="list-style-type: none"> • This chapter defines the riser system and its design requirements. It then discusses various types of riser system challenges.
Ch 4. Riser Concept Identification & Assessment
<ul style="list-style-type: none"> • This chapter identifies and assesses the various riser concepts installed with deepwater FPSOs worldwide. The assessment is done on two basis namely region wise and mooring type of FPSO.
Ch 5. Flexible Riser
<ul style="list-style-type: none"> • This chapter gives a brief definition and history of flexible risers. Thereafter it discusses its configuration, construction, ancillary components and design. It then throws light on current trend, future, advantages and limitations of flexible risers.
Ch 6. Rigid Metallic Riser
<ul style="list-style-type: none"> • This chapter gives a brief definition and history of rigid metallic risers. Thereafter it discusses its configuration, ancillary components and design. It then throws light on current trend, future, advantages and limitations of rigid metallic risers.
Ch 7. Hybrid Riser
<ul style="list-style-type: none"> • This chapter gives a brief definition and history of hybrid risers. Thereafter it discusses its configuration, components and design. It then throws light on current trend, future, advantages and limitations of hybrid risers.
Ch 8. Case Study
<ul style="list-style-type: none"> • A case study is done where an internal turret moored FPSO is considered in harsh environment of Northern Norwegian Sea. The aim of case study is to find a suitable riser concept which can be hooked to FPSO stationed in 1500m water depth in harsh environmental conditions of Northern Norwegian Sea.
Ch 9. Conclusion & Recommendation
<ul style="list-style-type: none"> • Suitable conclusions and recommendations based on the literature review and analysis is made in this chapter.
Ch 10 . Refernces
<ul style="list-style-type: none"> • List of refernces used while writing the thesis is mentioned.

2. FLOATING PRODUCTION SYSTEM

2.1 Definition and Components

It is a system which consists of sub-systems and production facilities to gather, process, store and distribute the produced fluid from offshore oil and gas fields. It has been utilised in shallow waters of 15m and also in deep water with depths more than 2500m. A general schematic of Floating Production System (FPS) with its primary components is shown below in Figure 2.1.

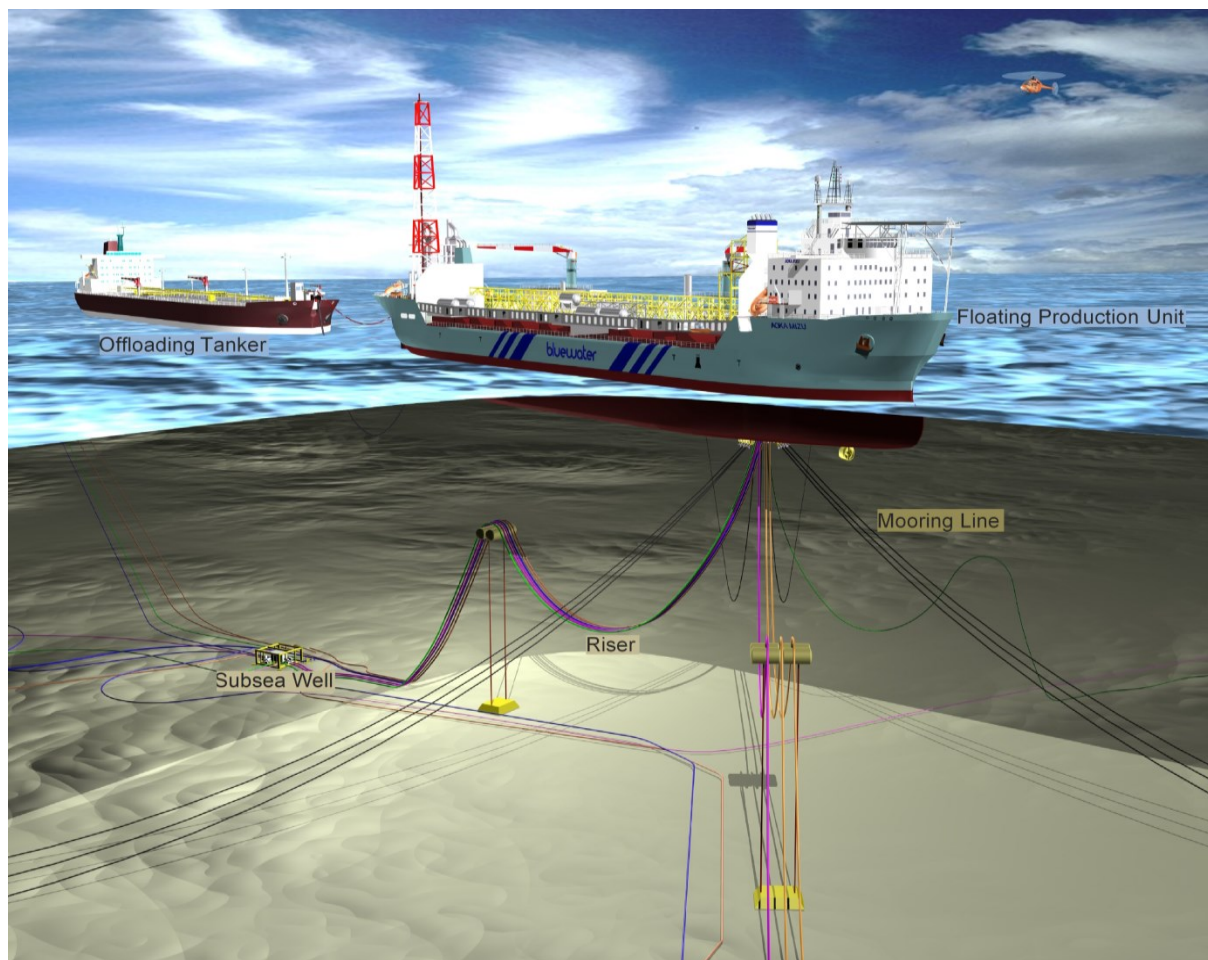

Figure 2.1 - General Schematic of Floating Production System (FPS)

The primary components of FPS as depicted in Figure 2.1 are:

- Well System:** The subsea well system is used with FPSO. The transportation of produced fluid between well and FPSO is done via subsea flowlines and risers. Different kinds of well configurations which can be used are single wells, manifold/cluster arrangement and template systems.
- Export and Storage Facilities:** The export facilities consist of export riser, and export pipelines which are used to transport stored oil either to onshore storage facility or to offshore loading buoy/ tanker via hoses.

- Mooring System:** It is used for station keeping of the FPU and comprises of anchors, mooring lines, fairleads, tuggers and winches. Various types of mooring systems are used in offshore industry based on the type of mooring line and its configuration. Most commonly used mooring systems are: steel chain catenary, wire catenary and taut polyester line. Anchors provide the holding power to FPSO either by embedding into the seabed or by sheer mass or combination of the two. Three main types of anchors are piled anchors, drag embedment anchors and suction anchors.
- Riser System:** It is used to transport fluid from the seabed to the top of the FPU and vice versa. Regardless of its function it is classified as tensioned riser, compliant riser and hybrid riser. Various materials like flexible, metallic and composite are used to manufacture risers which are used in various configurations like free hanging, wave shape and riser towers.
- Floater Unit:** It consists of either a specialized unit performing particular functions like production/ storage or a multipurpose unit like FPSO which is capable of performing several functions together. Different types of floater units used in offshore industry are shown in Figure 2.2.

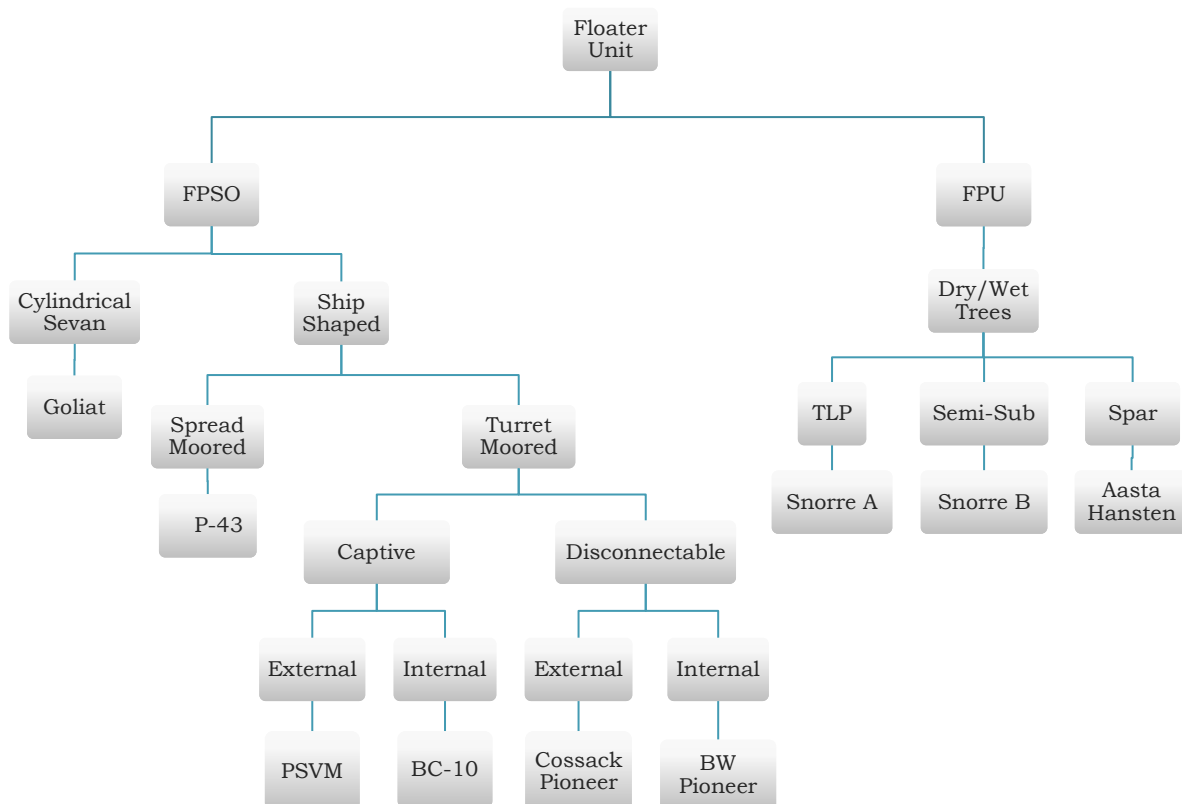

Figure 2.2 - Deepwater Floater Options

Different floater units have different response to sea wave energy and thus can be categorized as units with low dynamic response like TLP/Spar and units with high dynamic response like Semi-Sub/ FPSO. Ship shaped FPSO is the most widely used concept in offshore industry hence next section provides a brief discussion about them.

2.2 FPSO

2.2.1 General

FPSO is a floating facility installed above or close to an offshore oil and gas well to receive, process, store and export hydrocarbons via pipeline or offload it to a shuttle tanker. Out of the floater units stated in Figure 2.2; ship shaped FPSO has undoubtedly dominated the concept selection. This can be accounted to their easy installability and ability to store crude which permits their use in remote areas lacking pipeline infrastructure. Also the advantage of using them for Extended Well Testing (EWT) and pilot production to gather important reservoir data cannot be neglected. Some of the advantages offered by FPSO have been discussed in section 2.2.4 of this thesis.

2.2.2 Mooring System

In deepwater, FPSOs are stationed mostly using a mooring system which could either be spread mooring or turret mooring. The main factor governing the type of mooring system is the environmental conditions prevailing in the region. For example most of the FPSOs in West of Africa (WoA) are spread moored as the conditions over there are calm (Hs of 5m and Tp of 17s), while most of the FPSOs in offshore Brazil are captive turret moored which suits its moderate environments (Hs of 11m and Tp of 16s). The two mooring systems are discussed under:

Spread Mooring System: This system consists of a FPSO tethered to number of mooring lines (generally 12 to 22) anchored to seabed. The mooring lines are connected to both sides of the bow and stern of the FPSO in such a way that it maintains the fixed orientation of the vessel during its production lifetime. The heading of the vessel is dependent on the most severe environmental conditions prevalent in the region which makes it an obvious choice for calm and mono directional weather conditions of WoA. The risers for spread moored FPSO are connected to the port or starboard (or both sides) of the vessel depending upon the field layout and number of risers to be connected.

A different variant of spread mooring called as DICAS (Differentiated Compliance Anchoring System) was developed and patented by Petrobras in mid 90s for Campos Basin where FPSO encounters frequently changing weather from North East direction and highly extreme environment from South West. DICAS is modification of the conventional spread mooring system, in the sense that mooring lines at bow and stern have different stiffness which allows the vessel to weathervane up to some extent without the use of turret, thus providing storage, schedule and cost benefits over turret moored FPSO.

Turret Mooring System: This system is based on the concept of Single Point Mooring (SPM) which uses a mechanical structure called turret as the connection point of mooring lines and risers on the FPSO. The turret allows the vessel to weathervane freely around it, such that vessel orients itself into the most prevailing weather direction. Hence this system is favorable for multi directional moderate to harsh environments.

The turret can either be located within the hull of FPSO or it can be placed on the structure projecting out from the bow of the FPSO. The former one is called as internal turret system while the latter one is external turret system. External turret provides more storage capacity and schedule benefits over internal turret as the turret and vessel can be fabricated at same time in different fabrication yards for external turret FPSO. However the risers connected to external turret have higher heave response when compared to internal turret.

Turret (internal or external) of the FPSO can either be disconnected or remain fixed to the FPSO. The former configuration permits FPSO to disconnect and leave the site in case of emergency and hurricanes like in US GoM, Western Australia while the latter option requires FPSO to be stationed at the field for entire production life. The riser payload capacity of disconnectable turret is less than captive (permanent) turret since the turret has to carry the entire loads of riser, umbilical and mooring lines when disconnected from the FPSO.

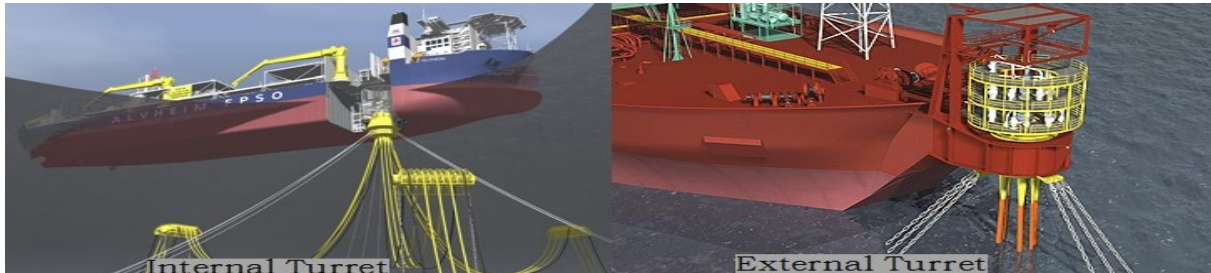

Figure 2.3 - Internal & External Turret Mooring System for FPSO [National Oilwell Varco, 2013]

When compared to spread mooring system, turret mooring offers advantages like lower loads on the mooring lines and more optimum offloading direction of the vessel. Further turret mooring system offers an added advantage in deepwaters of efficiently using the seafloor space, hence requiring shorter flowlines which renders better flow assurance and cost benefits. However turret moored FPSO has lower payload capacity than spread moored due to bearings at turret swivel interface which limit its load capacity. Some of the other differences between the two mooring system are stated in Table 2.1.

Characteristic	Spread Moored	Turret Moored
Vessel Orientation	Fixed	360 degree weathervaning
Environment	Mild to moderate, one directional	Moderate to extreme, multi directional
Field Layout	Not suitable for congested field.	Fairly adaptable and suitable for congested seabed.
Riser Number & Arrangement	Suitable for large riser numbers with capability of additional tie ins.	Suitable for medium riser numbers with moderate expansion capabilities.
Station Keeping Performance	Large number of anchor legs, offset is variable.	Less number of anchor legs, offset is minimized.
Vessel Motions	Varies from small to large depending upon relative direction of vessel and environment.	Motions are less as the vessel orients itself into the most suitable environmental direction.
Riser Connection	Risers are hanging from the porch on port/starboard side of FPSO	Turret provides the connection point for the risers.
Offloading Performance	Depends on vessel/environment orientation.	Better as the FPSO is aligned with the mean environment.
Storage Capacity	Large storage capacity available.	Storage is reduced for internal turret moored FPSO.

Table 2.1 – Spread Moored vs Turret Moored FPSO

2.2.3 Current Trend

According to International Maritime Associates (IMA) Inc.'s floating production report there were 250 FPU's worldwide in 2010 compared to 117 units in service in 2005, and 119 units in service in 2000. The 250 FPU's included 155 FPSO's, 42 semi-subs, 22 TLPS, 18 spars, 8 production barges, and 5 Floating Storage and Regasification units [Oil & Gas Journal, 2010]. The percentage distribution of various FPU's for 2010 is depicted in Figure 2.4.

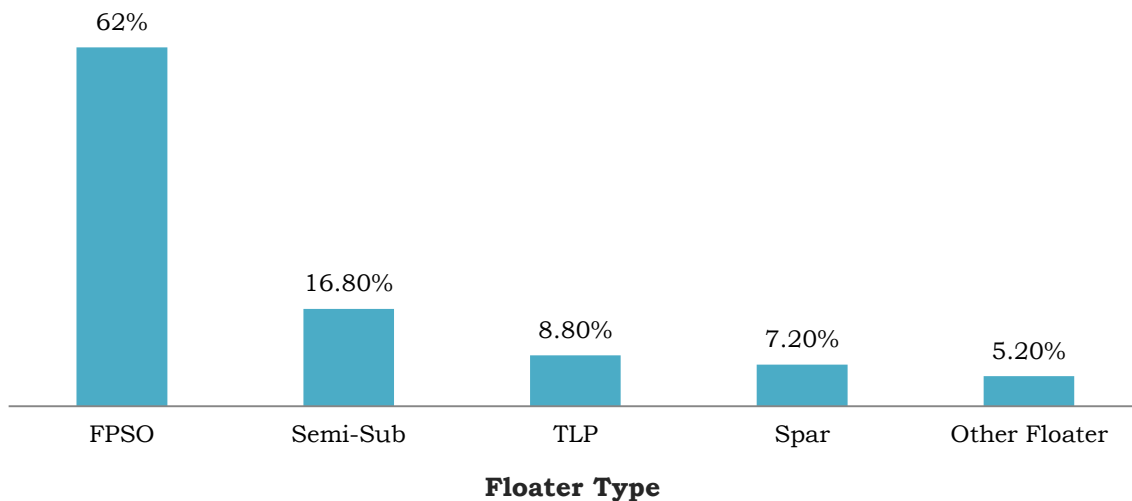

Figure 2.4 - FPU's percentage distribution for year 2010 [Oil & Gas Journal, 2010]

Figure 2.4 clearly depicts that FPSOs dominated the FPU market till 2010 and this dominance continued in 2013 as well and the number of operating FPSO's became 147, with maximum number of 37 in WoA followed by 28 units in offshore Brazil as can be seen from Figure 2.5.

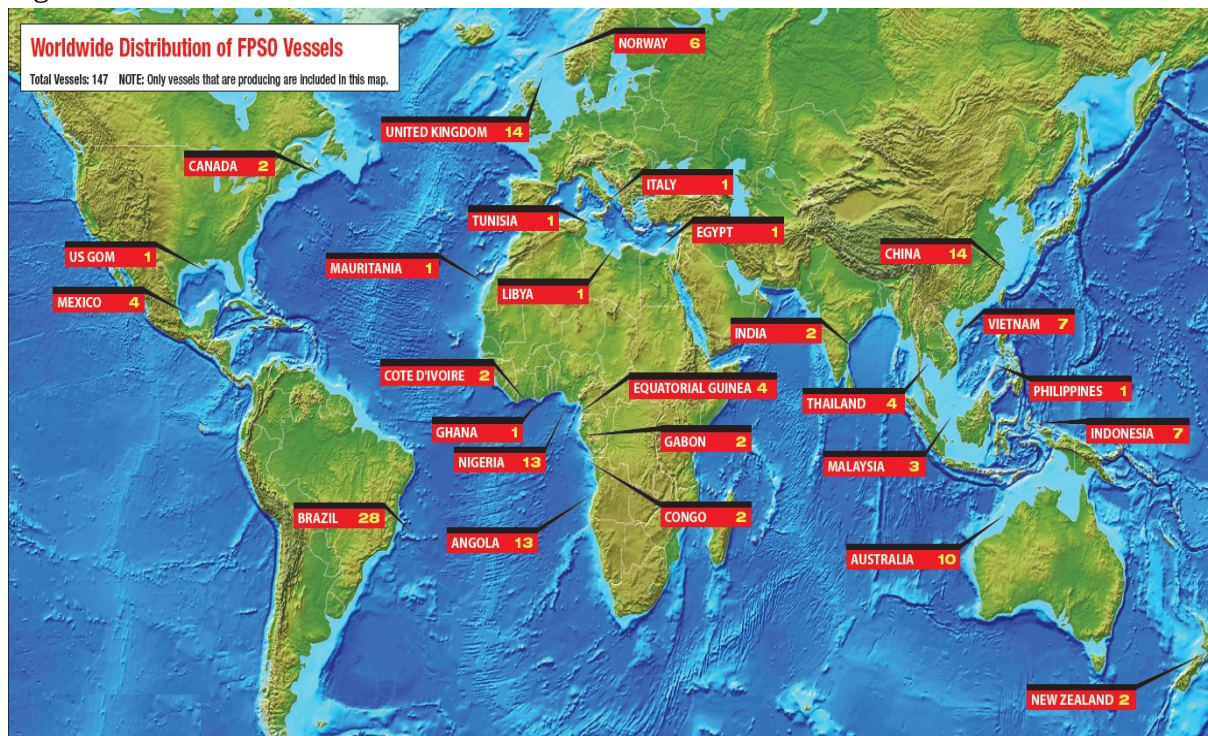

Figure 2.5 - Worldwide Distribution of FPSO Vessel [Offshore Magazine, August 2013]

Most of the FPSOs in South East Asia and South China Sea are in shallow to medium water depths. For e.g. all the 14 FPSOs in offshore China are stationed between 15m to 135m water depth. Similarly in North Sea these are utilized mostly for mid water depths. But this trend is not followed in offshore Angola and Brazil where nearly 77% and 88% of the FPSOs are stationed in water depth greater than 600m respectively.

Tabell 0.1 in Appendix A shows the main characteristics of worldwide FPSOs operating in deepwater (> 600m). A summary of Tabell 0.1 is presented in Figure 2.6.

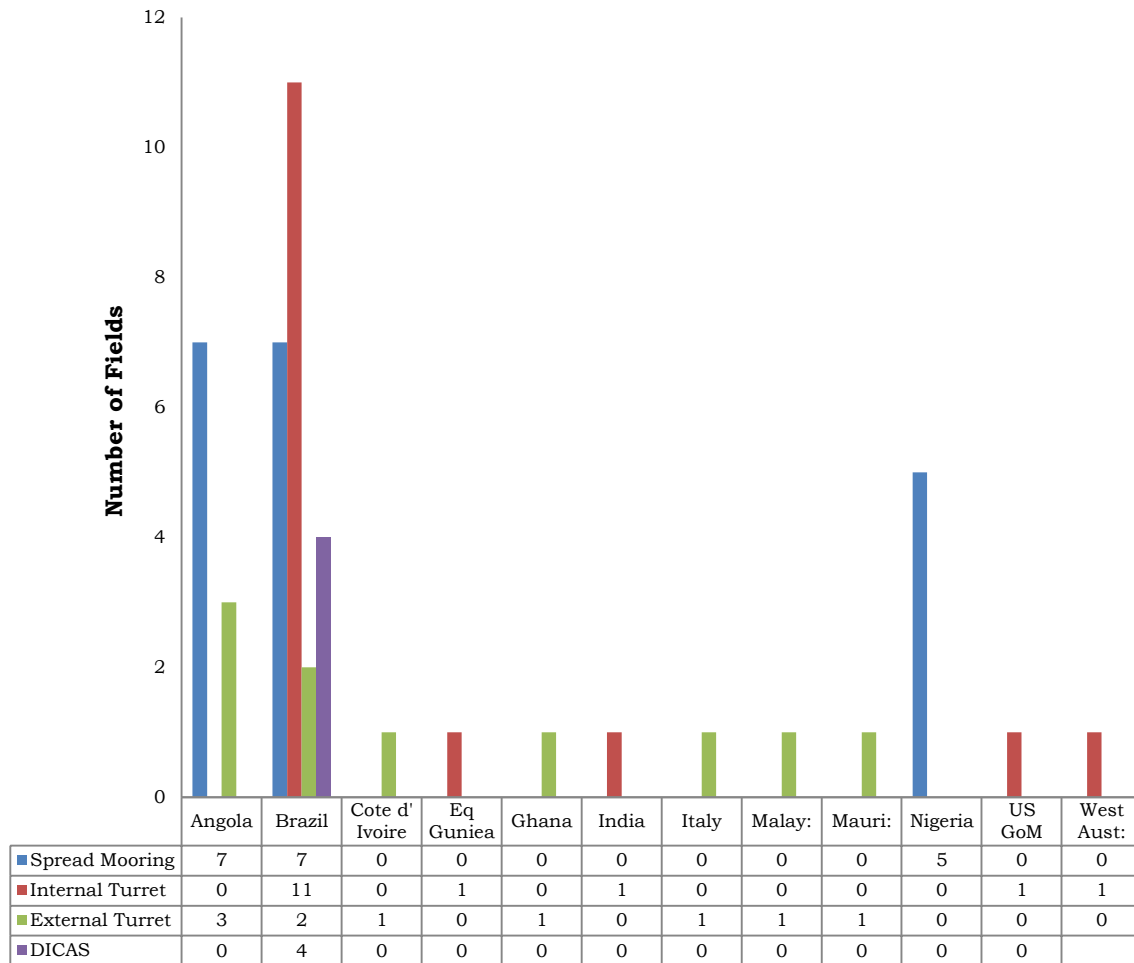

Figure 2.6 - FPSO in Deepwater (>600m) at Various Location

Key Findings: A close look at Figure 2.6 indicates that for benign environments of Angola and Nigeria, spread moored FPSO has been utilized the most and there is no internal turret moored FPSO in these regions.

In the moderate and multi directional environment of Brazil turret moored FPSOs dominate which allow 360 degree weathervaning of the FPSO. A special case of spread mooring called as DICAS also allows FPSOs to weathervane to some extent and is used in Brazil only.

The internal turret used on FPSOs stationed in hurricane prone areas of India, US GoM and Western Australia is of disconnectable type which can be disengaged from the FPSO in case of extreme storms, thus setting FPSO free to leave the site.

2.2.4 Evolution and Future

At present Petrobras leads the deep water FPSO industry amongst offshore field operators. It first used FPSO in the year 1979 and ever since then the company has been actively engaged in evolution of this floating vessel [Brandao & Henriques, 2007]. This evolution in Brazilian deepwater FPSO industry can be divided into three phases and Table 2.2 lists the main attributes in which FPSO saw changes during this evolution.

CHARACTERISTIC	PHASE		
	I-1979 to 1993	II-1995 to 2001	III-2002 to 2006
Size & Capacity			
Processing Capacity (bpd)	< 60,000	~ 100,000	180,000
Ship Size	Panamax, Aframax	VLCC	VLCC
Gas Compressors	Moto - Compressor (<600,000m ³ /d)	Turbine Compressor (1-2 MMm ³ /d)	Moto - Compressor (2 MMm ³ /d)
Main Generation	Steam Boilers + Moto Generator (<1MW)	Steam Boilers or Turbine Generator (5-10MW)	Turbine Generator (23 MW)
Water Treatment	Very Limited	Full With Some Bottlenecks	Full
Water Injection Capacity	None	Full With Some Bottlenecks	Full
Cargo Handling	2 Cranes	3 Canes	3 Cranes + Monorail
Contract Requirements			
Strategy	Internal Procurement	1 EPC, Lump Sum Contract	3 - 5 EPCs
Design Life	5 - 10 Years	20 Years	25 Years
Conversion Philosophy	Limited Refurbishment of Existing Equipment	Full Refurbishment of Existing Equipment	Full Replacement of Equipment
Design Concept			
Mooring	Single Point Mooring on Tower/Buoys	Turret Moored	Turret/Spread Moored
Subsea Arrangement	Satellite Wells or Small Subsea Manifolds	Large Subsea Production and Injection Manifolds	Satellite Wells Directly Connected to the FPSO
Plant Support	Skids Supported Over Ship Deck	Skids Mounted Over "Pancake"	Modules Over Stools
Materials (Piping & Vessel)	Mainly Carbon Steel	FRP, CU-Ni and CCS	Duplex Stainless Steel
Control of Ship Motions	Existing Bilge Keel	Existing Bilge Keel	Bilge Keel Enlarged & Extended
Offloading System	Floating Hoses in Water	Submerged Hoses Stored in Cradles Along Deck	Floating Hoses Stored in Reels

Table 2.2 - Phases of Deepwater FPSO in Offshore Brazil [Brandao & Henriques, 2007]

At present the fourth phase of the evolution is going on in the Brazilian FPSO industry and P-57, P-58 and P-63 FPSOs are the outcome of this phase. In the fourth phase more efforts are being put in optimizing the design and layout of FPSO as it seems to be the most widely used concept in offshore industry in the future.

This premise is bolstered by the forecast made in new edition of the Douglas-Westwood's report which claims that "a total of 134 FPS will be installed worldwide from 2012 to 2016 with a global Capex of approximately USD 68 billion, 80% of which will be directed towards FPSO installations" [E&P Magazine, 2011]. The forecasted percentage distribution of 134 FPSU to be installed in the period 2012-2016 is shown below in Figure 2.7.

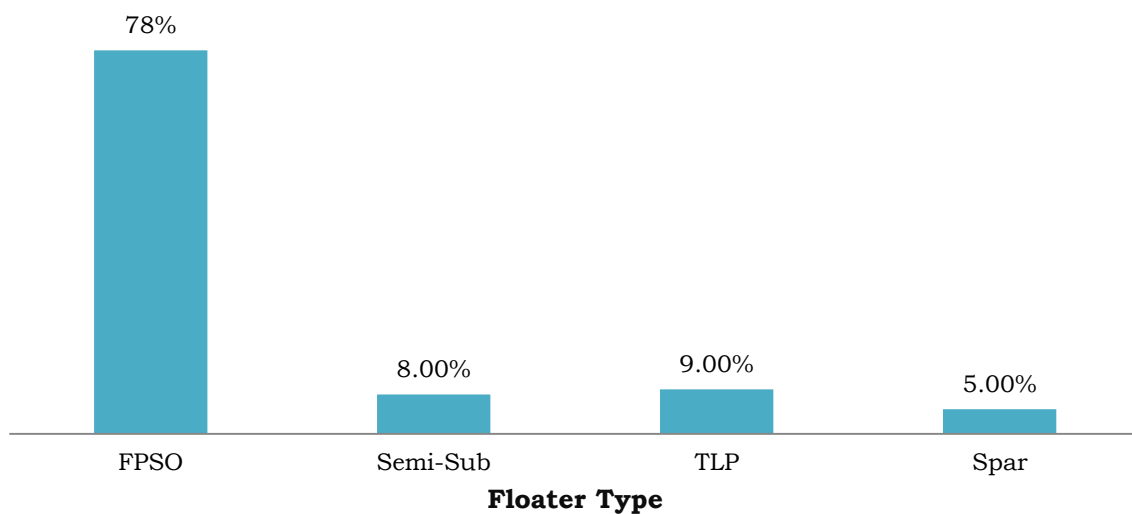

Figure 2.7 - Forecast of FPSUs percentage distribution for 2012-2016 [E&P Magazine, 2011]

The data and discussion presented in section 2.2.3 and 2.2.4 indicate that FPSO has been and will be the most widely used floater unit for offshore field development especially in deepwaters. However its use in US GoM is limited due to the extensive pipeline in the region which negates the requirement of onsite storage.

2.2.5 Advantages

Some of the reasons which make FPSO as the most widely used FPSU option are:

1. In areas which lack pipeline infrastructure, FPSO offers lower Capex as it uses shuttle tankers (which can be leased) in comparison to construct new export pipeline which is the only option with other FPSU alternatives.
2. Since FPSO is a mobile unit so it can be easily moved to another location in case of subsurface surprises at one location.
3. Time difference between the discovery and first oil is least if the field is developed with FPSO.
4. It is a very adaptable concept as it offers large deck space and possibility for future expansion infrastructure.
5. FPSO is the most preferred concept in harsh weather conditions because of its ability to weather wane and quickly disconnect in case of an emergency. This feature is however possible only for turret moored FPSO and to some extent for DICAS moored FPSO.

6. It can be used in Extended Well Testing (EWT) and pilot production to collect necessary information about the field, such as drilling data, reservoir parameters and fluid properties.
7. Most of the FPSOs are modification and refurbishment of the old VLCC, thereby giving cost and schedule benefits to the operator.

2.3 Discussion and Conclusion

The key conclusions which can be made from the chapter are:

1. FPSOs have been utilized in water depths ranging from 15m to 2500m and have dominated the FPU market till now. Even in the future the same trend is expected to continue.
2. With the passage of time FPSOs have seen evolution and transformation in terms of features like size, capacity, contract requirements and design concept etc.
3. It is a common practice to use spread moored FPSO for benign environments of WoA and turret moored FPSO for moderate to harsh environment prevailing in Brazil and US GoM respectively.
4. FPSOs are typically suited for marginal and remote fields which lack adequate pipeline infrastructure.

3. RISER SYSTEM

3.1 Definition and Description

Riser system is defined as the interface between a static subsea facility and the dynamic Floating Production Unit (FPU) at the sea surface. During its operational life time it should not only maintain fluid and pressure containment but also it should be structurally and globally stable [API RP 2RD, 1998]. Figure 3.1 shows essential functional elements of the riser system.

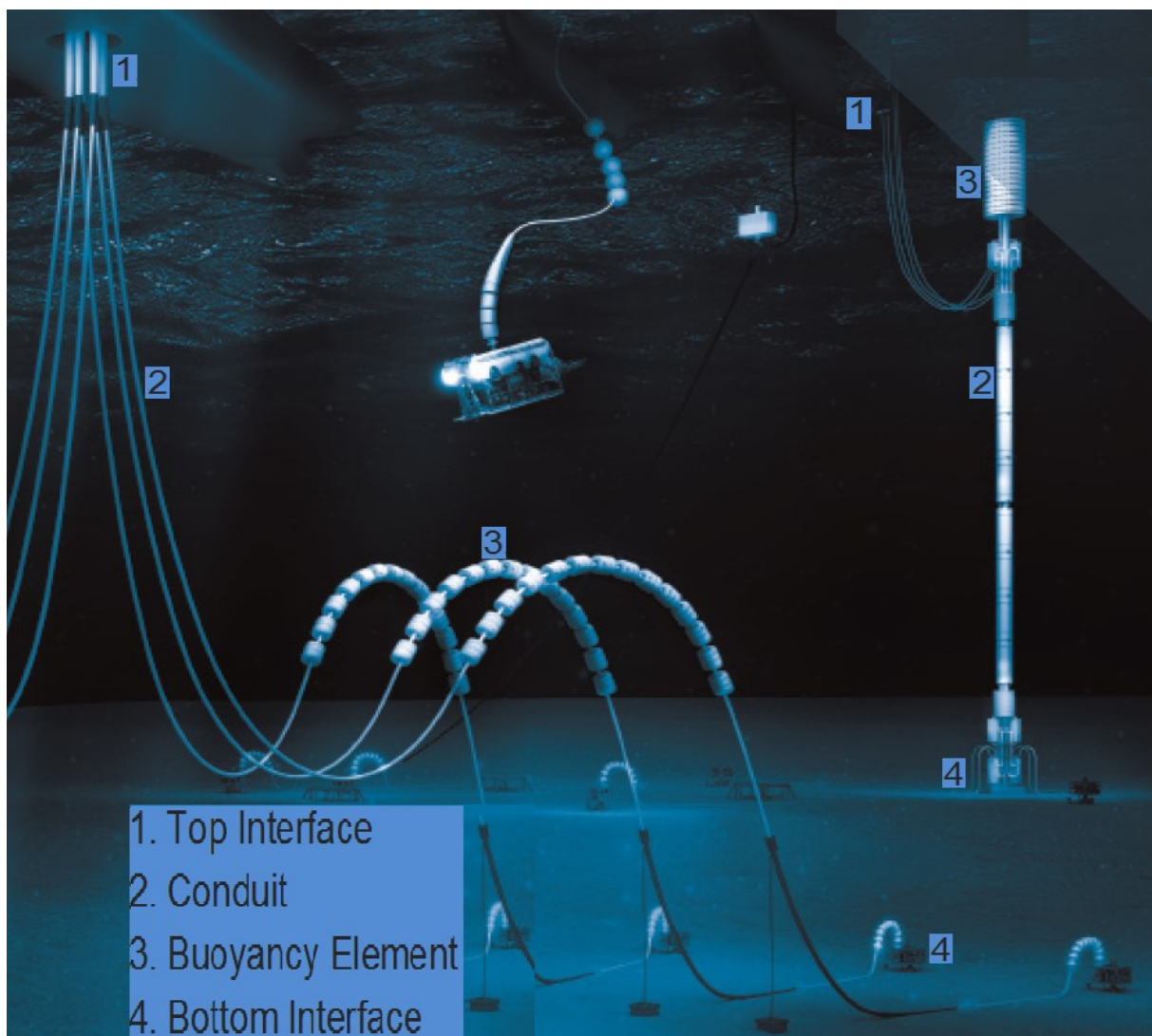

Figure 3.1 - Elements of FPS Riser System [Balmoral Offshore Engineering Catalogue, 2012]

From Figure 3.1 the two essential features of riser system are:

- 1. Riser Body:** The conduit marked as 2 is the riser body which depending upon the project requirements can be made of metal or flexible pipe. Its main purpose is to transfer produced fluid between the subsea facility and FPU at sea surface. Additionally it can also serve as a mooring element.

Metal pipe is generally a classic API 5L pipe which can either be segmented or continuous. The segmented pipes are of lengths (about 12m) which can be easily handled, transported and installed. Once these small segments reach the installation site these are then either welded or joined with the help of mechanical connectors on the deck of installation vessel to the desired length.

The continuous pipes on the other hand are either towed or transported in reeled form on vessels to the site. The towed pipes are upended at the site whereas the reeled pipes are uncoiled and installed. Like continuous metal pipes, flexible pipes which mostly have unbonded metallic structure are also transported in big reels/carrousel and on reaching site these are uncoiled and installed from installation vessel.

2. System Interface: While designing riser system, designer should not only focus on the design of the riser body but he must also pay attention to the top and bottom interface of the riser with FPSO and seabed respectively. At both these locations all the components and equipments must be present which are required for connection, installation, operation, maintenance and removal of the riser body [API RP 2RD, 1998]. All of these components should be designed to withstand all kinds of riser loads, to maintain fluid containment and system integrity during all the phases.

3.2 Riser System Design Consideration

Riser system design is covered by number of industry specifications and international standards. All of these are based on four fundamental design aspects:

- Load and Environmental Conditions
- Analysis Methodology
- Design Criteria and
- Materials

The design of risers is based on the limit state which according to DNV-OS-F201 is “the state beyond which the riser or part of the riser no longer satisfies the requirements laid down to its performance or operation”. Thus the main objective of design is not to exceed the required failure probability by identifying all possible modes of failure.

Though all the designers have same design objective but the designing methods can vary. Some of the commonly applied design methods as stated in DNV-OS-F201 are:

1. Load and Resistance Factor Design (LRFD) Based Design
2. Working Stress Design (WSD) Based Design
3. Reliability Based Design
4. Design by Testing

Amongst these design methods first two are the basis of the very important riser design codes namely API RP 2RD (WSD) and DNV-OS-F201 (LRFD). While for designing unbonded flexible risers API Specification 17J employing WSD methodology is used, the design of rigid (metallic) risers may follow recommendations of API RP 2RD (WSD) or of DNV-OS-F201 which adopts the new LRFD format. The design format of these two codes is discussed next.

LRFD Based Design: As stated in DNV-OS-F201 “the fundamental principle of LRFD method is to verify that factorized design load effects do not exceed factored design

resistance for any of the considered limit states”. The general LRFD format for design criteria where it is possible to separate load effects and resistance is:

$$S_d (S_p; \gamma_F.S_F; \gamma_E.S_E; \gamma_A.S_A ;) \leq R_k / (\gamma_{SC}.\gamma_m.\gamma_c)$$

Where:

S_d = Design load

S_p = Pressure loads

S_F = Load effects from functional loads

S_E = Load effects from environmental loads

S_A = Load effects from accidental loads

γ_F = Load effect factor from functional loads

γ_E = Load effect factor from environmental loads

γ_A = Load effect factor from accidental loads

R_k = Generalized resistance

γ_{SC} = Resistance factor to take account into the safety class

γ_m = Resistance factor account for material and resistance uncertainties

γ_c = Resistance factor to account for special conditions

The format clearly shows that this approach uses different safety factors for load effects and associated resistance. It also considers different limit states which can be divided into following categories:

- **Serviceability Limit State (SLS):** The condition to fulfill this limit state is that the riser should maintain its functionality during the entire service life. The functionality in case of production riser is to transfer well fluid between subsea well and FPU without leakage.
- **Ultimate Limit State (ULS):** The condition to fulfill this limit state is that the riser should maintain its structural integrity not necessarily functionality during its entire service life. For operating condition this limit state corresponds to the maximum resistance to applied loads with 10^{-2} annual exceedance probability [DNV-OS-F201, 2010].
- **Accidental Limit State (ALS):** The condition to fulfill this limit state is that the riser should maintain its structural integrity not necessarily functionality even when it is subjected to accidental loads.
- **Fatigue Limit State (FLS):** The condition to fulfill this limit state is that the riser should maintain its structural integrity not necessarily functionality even when it is subjected to cyclic loads which can cause its fatigue damage.

WSD Based Design: As stated in DNV-OS-F201 “it is a design format where the structural safety margin is expressed by one central safety factor or usage factor for each limit state.” The general WSD format for design criteria where it is possible to separate load effects and resistance is:

$$S_d(S) \leq \eta.R_k$$

Where:

η is called as usage factor which takes care of the uncertainties in load effects and resistance. It is also called as Allowable Stress Factor or Design Factor in some WSD codes.

It is clear from the format of these two methods that WSD is a conservative approach while on the contrary LRFD approach is a more consistent design method. In the past most of the riser systems were based on WSD approach but now designers are showing propensity toward LRFD approach as the design based on this approach is more accurate and hence economical. The most updated edition of API RP 2RD also talks about the LRFD approach which shows growing popularity of this approach.

Detailed design of unbonded flexible riser using WSD format is in chapter 5 while design of metallic rigid riser employing LRFD format is discussed in chapter 6 of this thesis.

3.3 Riser System Challenges

3.3.1 General

Oil & Gas industry is embarking its journey towards more challenging fields which are characterized by:

- Water depths up to 4000m.
- Harsher environments like Barents Sea.
- Pressures up to 20000 psi.
- Temperatures beyond 170 degree Celsius.
- Sour service and CO₂ conditions.
- Complex flow assurance conditions.

However since in this thesis the focus is on appraising riser concepts for FPSO in deepwater and finding a suitable riser concept for deepwater harsh environments which can be used with FPSO, so challenges related to only three parameters namely deepwater, harsh weather and FPSO will be discussed.

3.3.2 Deepwater Challenges

At present deepest FPSO is stationed at 2500m water depth in Cascade and Chinook field (US GoM). Shell has also planned to develop Stones field (US GoM) with a FPSO which will be stationed at 2900m water depth. Designing risers for such deepwater fields is a daunting task due to the various challenges posed by deepwater:

- **High Riser Weight:** Increase in water depth correspondingly increases the riser weight which imposes following challenges:

- I. Increased riser weight means high top tension requirements during installation of the riser which limits the number of appropriate installation vessel.
- II. For coupled riser concept increased riser weight imposes large vessel payloads thereby reducing the load carrying capacity of the FPSO.
- III. Top section of riser is under combined influence of tension and bending loads and hence prone to fatigue. Increase in riser weight means increase in tension loads and fatigue.

- **High Hydrostatic Pressure:** Calculations show that for every 1m increase in water depth the external hydrostatic pressure increases by 0.1 bar. So riser section installed at

2000m would be facing 200 bar of external hydrostatic pressure which can cause collapse of the riser if it is not designed properly. To prevent the collapse thick walled risers (rigid) are required which are costly to fabricate. Thus with the increase in water depth both complexity and cost of the riser increases.

- **Increased Heat Loss:** Due to increase in water depth the length of the riser also increases which means that surface area of heat loss increases hence causing more thermal losses.

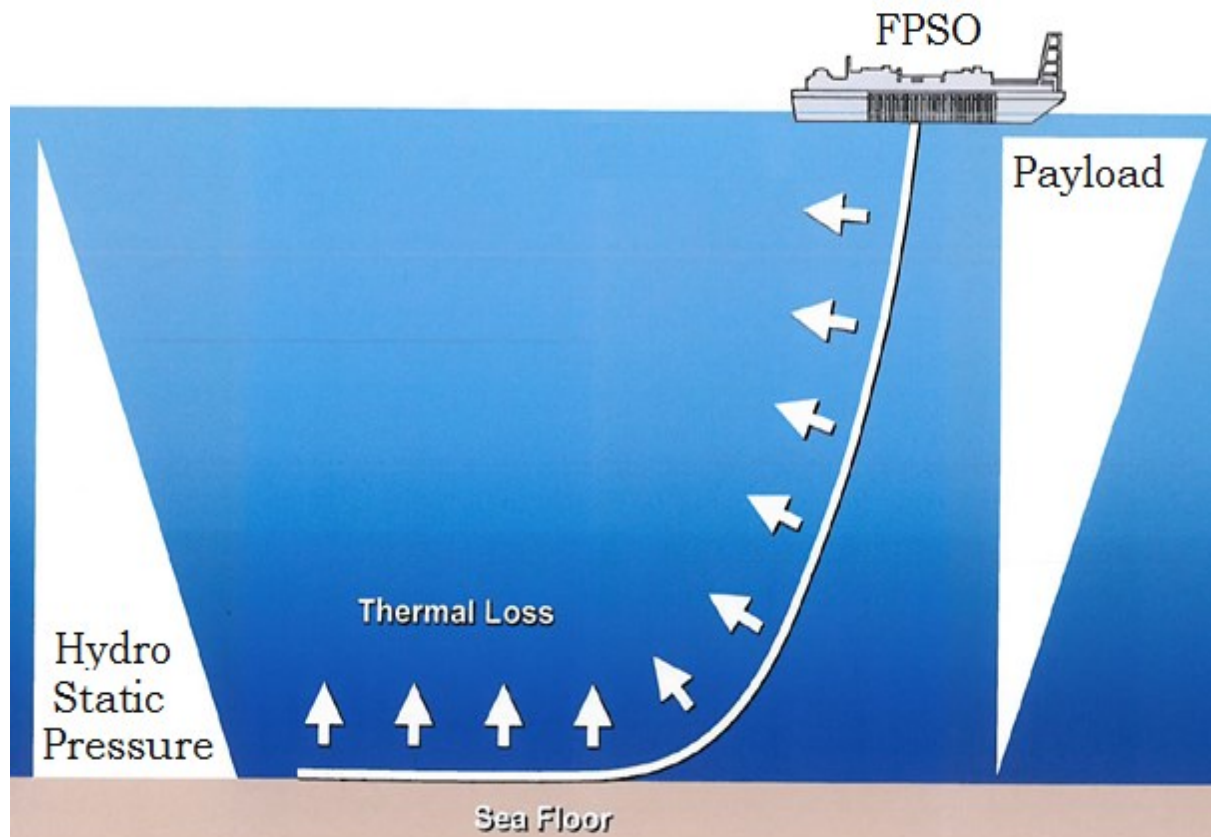

Figure 3.2 - Deepwater Challenges on Riser

- **Increased Riser Spread:** SCRs require a radial spread of 1 to 1.5 times of the water depth they are installed at [Howells and Hatton, 1997]. So with the increase in water depth the corresponding SCR spread increases which can become a hassle in congested fields.
- **Increased Pressure Gradient:** As the water depth increases the pressure difference between entry and exit of the riser fluid. If this fluid is a gas then it leads to its expansion and subsequent cooling due to Joules Thompson effect which increases the chances of hydrate formation thereby causing flow assurance issues.

3.3.3 Harsh Environmental Challenges

Environmental conditions vary from one region to another, with benign environments common in WoA while harsh conditions prevail in Northern Norwegian Sea, Western Australia and US GoM. Table 3.1 shows various environmental parameters prevalent in different deepwater regions of the world.

Characteristic	Category of Environment					
	Benign	Benign	Moderate (Winter Storm)	Moderate	Extreme (Hurricane)	Extreme
Region (Field Name)	Nigeria (Erha)	Angola (CLOV)	US GoM	Brazil (Sao Paulo)	US GoM	North Norwegian Sea
Water depth (m)	750-2000	1000-1400	2000	2200	2000	1500
100 Year Hs (m)	3	5	8.8	11.6	15.8	17
100 Year Tp (s)	14.5	15	7.5	16.3	15.4	18.8
100 Year Surface Current (m/s)	1.35	2	2.2	1.05	2.2	1.65

Table 3.1 - Region Specific Environmental Conditions

From Table 3.1 it can be seen that offshore Nigeria and Angola are characterized by benign sea condition with unidirectional swells (small wave height and large period waves). For Brazil the waves come from many directions and are generally having moderate significant height, and currents. However Northern Norwegian Sea and US GoM (during hurricane) experience extreme wave heights and periods. Environmental challenges in world's major offshore oil and gas production regions have been shown in Figure 3.3.



Figure 3.3 - Region Specific Environmental Challenges

The challenges related to harsh environmental conditions from riser design point of view are [Karunakaran et al, 2005]:

- Large Vessel Offsets:** FPSOs can undergo large excursions in harsh environments. For the coupled risers this can be problematic as they can undergo excessive tension/compression in extreme cases, thus causing riser to fail. Also riser concepts like

SCR and free hanging flexible which are suitable for benign to moderate environmental conditions becomes impractical in harsh environments.

- **High Dynamic Response:** Coupled riser concepts like free hanging flexible and SCR are subjected to high dynamic response from the FPSO motions in extreme environments. Such a massive response could cause compression of the riser at TDZ and also clashing of light weight risers with adjacent risers/mooring lines.
- **Increased Vessel Payloads:** It is known that the loads imposed by riser on FPSO increases by about two times in harsh environments conditions due to massive dynamic response of the riser [Howells and Hatton, 1997].
- **Critical in Fatigue Performance:** SCRs with high thermal insulation tend to be very light in water and thus under harsh environments are subjected to high dynamics which makes them prone to fatigue during their operational life.

3.3.4 Challenges Due to FPSO

Selecting a riser concept for FPSO is considered challenging as compared to doing the same for other FPU's like TLP or Spar. This is mainly because of two reasons:

- **Considerable FPSO Motions:** Besides the above mentioned challenges, riser design and concept selection considerably depends upon the motion characteristics of the FPU to which they are to be connected. All the FPU's have their periods of horizontal motions (surge, sway & yaw) greater than 100s; hence they are 'soft' in horizontal plane. But they have considerably varying periods of motions in vertical plane (roll, pitch & heave) as shown in Table 3.2.

Mode	Natural Period (seconds)			
	Semi-Sub	FPSO	TLP	Spar
Surge	>100	>100	>100	>100
Sway	>100	>100	>100	>100
Yaw	>100	>100	>100	>100
Roll	30-60	5-30	< 5	50-90
Pitch	30-60	5-12	< 5	50-90
Heave	20-50	5-12	< 5	20-35

Table 3.2 - Typical Deepwater FPU Natural Periods [DNV-RP-F205, 2010]

As can be seen from Table 3.2 that for FPSO natural periods of pitch and heave varies between 5s to 12s while natural period of roll lies varies from 5s to 30; hence all three lie in the same frequency range of wave energy. For FPSO the most considerable mode is heave as large strokes of about 40m can be experienced during extreme conditions which render Top Tensioned Risers (TTRs) impractical with FPSO.

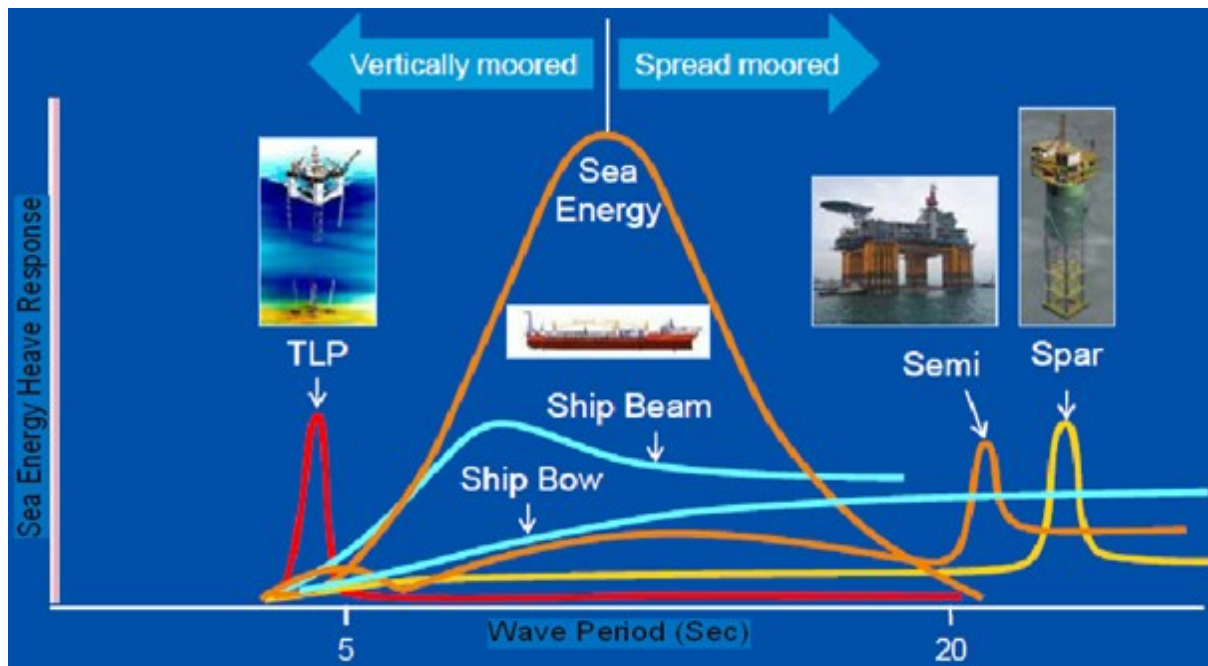

Figure 3.4 - Natural Period of Floaters vs Wave Period [Uppu, 2012]

Figure 3.4 clearly depicts that amongst all the FPU's, only heave period of FPSO lies in the same spectrum of the sea energy. If the wave period matches with the natural heave period of the FPSO then resonance would occur thereby causing severe FPSO motions and enormous riser response which is problematic for the reasons already discussed.

One way to reduce riser dynamics is to mitigate FPSO motion by using bilge keels and Dynamic Positioning (DP) system while another way to accommodate such massive vessel offsets and motions is to use more compliant riser configuration (like lazy wave flexible /SLWR) or uncoupled riser system (like SHR/HRT/BSR), both of which are challenging riser concepts from design and installation point of view.

- **Space Limitation for Riser Accommodation:** Another challenge particularly on turret moored FPSO is limited space within the turret which can cause congestion of risers and mooring lines. This can be problematic during installation and operation phase as clashing may occur between the close spaced risers and mooring lines.

Besides above mentioned challenges due to deepwater, harsh environments and FPSO, some of the major factors which must be taken into account while selecting riser concept for FPSO are:

- Type of mooring on FPSO i.e. spread moored or turret moored.
- Location of turret in FPSO.
- Characteristics of produced fluid (sour or sweet).
- Nature of reservoir i.e. HP/HT.
- Flow assurance and thermal requirement.
- Field layout, subsea footprint and configuration.
- Seabed condition and interaction.
- Ease of installation and installation schedule.
- Capex and Opex.
- Pigging requirements.

3.4 Discussion and Conclusion

The key conclusions which can be made from the chapter are:

- 1.** Design of unbonded flexible riser is based on WSD methodology stated in API codes while design of rigid risers may follow recommendation of API-RP-2RD (WSD) or of DNV-OS-F201 employing LRFD format.
- 2.** Just like FPU selection, riser concept selection also depends upon the location where it is to be installed. For e.g. riser concept for WoA which is characterized by benign environmental conditions is different from offshore Brazil which has moderate climatic conditions.
- 3.** Designing risers for FPSO stationed in deepwater harsh environment is a daunting task as for such conditions riser is subjected to huge dynamics which is critical for reasons like huge vessel payload, fatigue etc.

4. RISER CONCEPT IDENTIFICATION & ASSESMENT

4.1 Review

Owing to the challenges due to deepwater, harsh environment and FPSO, selecting the riser concept for the same is a daunting task. Tabell 0.1 in Appendix A presents a review of riser concepts which has been installed worldwide with FPSOs in deepwater till now.

4.2 Identification & Assessment

Based on the data of Tabell 0.1, riser concepts which have been used with FPSO in deepwater are shown in Figure 4.1.

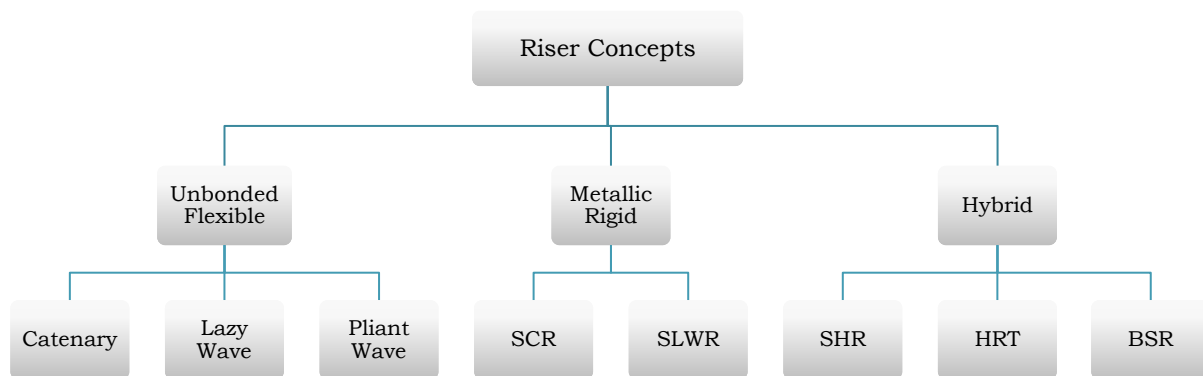

Figure 4.1 - Installed Riser Concepts with FPSO in Deepwater

Note: SHR includes single line riser and concrete Offset Riser (COR)

These riser systems can be categorized into two groups:

➤ **Coupled Riser:** The risers which are directly connected from FPSO to seabed such that host vessel motions are directly transferred to the riser segment and the TDZ, are called as coupled riser. These include:

- Catenary or Free Hanging Unbonded Flexible Riser
- Lazy Wave Unbonded Flexible Riser
- Pliant Wave Unbonded Flexible Riser
- Steel Catenary Riser (SCR)
- Steel Lazy Wave Riser (SLWR)

➤ **Un-coupled Risers:** The riser concepts in which the subsurface buoy acts as an interface between the rigid riser (vertical or catenary) connected to seabed and the flexible jumper attached to FPSO, such that most of the vessel motion is taken by jumper thereby making rigid portion of the riser free from vessel motions are called as uncoupled riser concepts. These include:

- Hybrid Riser Tower (HRT)
- Single Hybrid Riser (SHR)
- Buoyancy Supported Riser (BSR)

In order to find the region where the identified riser concepts are installed, the data of Tabell 0.1 has been summarized in Table 4.1. The table shows the number of worldwide deepwater FPSOs with their riser concept.

Coupled					Uncoupled			Country
Catenary Flexible	Lazy Wave Flexible	Pliant Wave Flex.	SCR	SLWR	SHR	HRT	BSR	
4	1	-	-	-	3*	2*	-	Angola -10
20	1	-	-	1	-	-	2	Brazil -24
1	-	-	-	-	-	-	-	Cote d'Ivoire -1
1	-	-	-	-	-	-	-	Eq Guinea -1
-	-	1	-	-	-	-	-	Ghana -1
-	-	1	-	-	-	-	-	India -1
1	-	-	-	-	-	-	-	Italy -1
-	1	-	-	-	-	-	-	Malaysia -1
-	1	-	-	-	-	-	-	Mauritania -1
1	-	-	3	-	1	-	-	Nigeria -5
-	-	-	-	-	1	-	-	US GoM -1
-	1	-	-	-	-	-	-	Western Australia -1
28	5	2	3	1	5	2	2	Total = 48

Table 4.1 - Number of Worldwide Deepwater FPSOs with their Riser Concepts

Note: * Rosa and Girrasol HRT are attached to the same FPSO, and 2 HRTs & 1 SHR installed with CLOV- FPSO are not included here as the field is still under development with first oil expected in mid-2014.

It is clearly visible from Table 4.1 that flexible riser in catenary configuration has been the most widely concept for deepwater field development in the world till now. Further riser assessment shall be done in two parts: region wise and mooring type.

4.2.1 Region Wise

For the assessment purpose the regions are divided into following four parts:

- **Brazil:** In Brazil most of the fields in the Campos Basin are under 1500m water depth and have been developed by flexible riser in catenary configuration. This is because of its ability to accommodate large bending curvature which blesses flexibles with dual benefits of easy installation and tendency to adjust large vessel offsets. Also they can be easily recovered, inspected, repaired, re-laid and connected in new sites, thus providing the best means of producing in short time [Neto et al, 2001].

However the Brazilian fields in water depth excess of 1500m have not been developed by using free hanging flexible riser. This is because of its enormous weight which tends to induce high top tensions and high vessel payloads. To overcome these drawbacks a more compliant riser configurations like lazy wave flexible/steel risers or uncoupled riser concepts like Buoyancy Supported Riser (BSR) are required. This can be seen in BC-10 (>1700m) field and recently developed pre salt fields of Santos Basin which are in water depths exceeding 2000m. These fields have utilized SLWR and BSR concepts respectively due to benefits like reduced top tension, less vessel payloads, lower TDP movement, improved fatigue life and better thermal performance.

Key Identification: The key identification for offshore Brazil is that majority of deepwater FPSOs have coupled riser concepts of which free hanging flexible riser dominate. Only two pre salt fields in Santos Basin have used the novel uncoupled BSR concept.

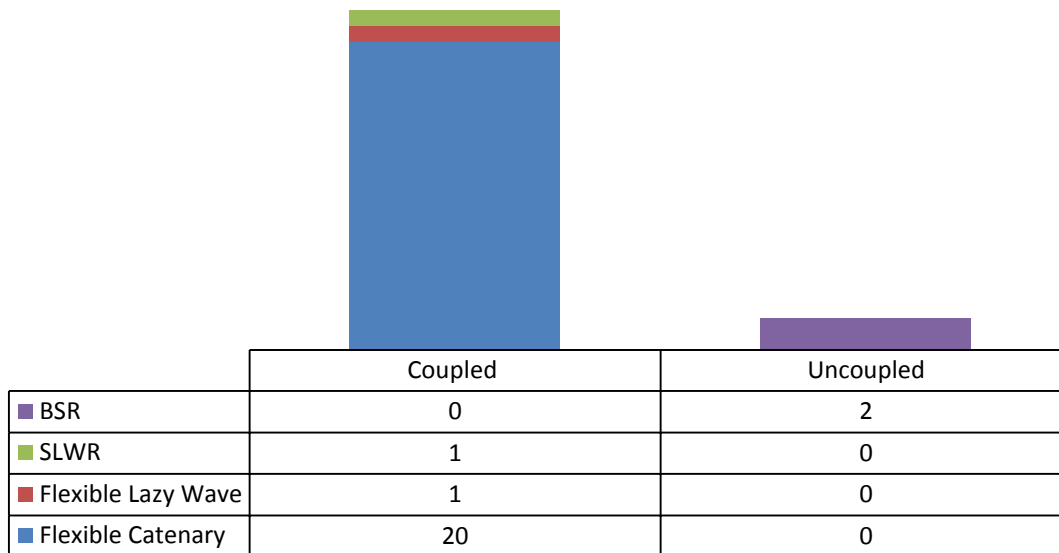

Figure 4.2 - Number of Deepwater FPSOs with their Riser Concepts in Offshore Brazil

- Nigeria:** The environmental conditions in Nigeria are relatively calm with one directional swells dominating the sea. For such benign environment spread moored FPSOs are obvious choice and since all the deepwater fields are in water depth less than 1500m so catenary risers seems to be preferred riser configuration. This statement is validated by the data shown in Tabell 0.1 which depicts that all the 5 FPSOs are spread moored and 4 of them use catenary riser configuration (1 flexible & 3 SCR).

SCR was first used with FPSO in Bonga field in 2004 and since then it has been used in two more fields Erha and AKPO, all three of which lie in offshore Nigeria. As a matter of fact it is clearly visible from Table 4.1 that in entire world only offshore Nigeria has SCRs coupled with FPSO. The primary reason for this can be accounted to the calm metocean conditions, simplicity in design and cost efficiency of SCR; while other reasons could be project specific. For e.g. some of the reasons why SCR was chosen as suitable concept for AKPO field are [Gueveneux, 2010]:

- To make bidding process easier as more number of contractors had ability to fabricate and install SCR as compared to other available concepts like flexibles, HRT and SHR.
- Flow assurance conditions didn't demand the use of Pipe in Pipe option and could be met by using wet insulation which favored SCR over IPB, HRT and SHR.
- The involvement of local content was maximum in case of SCR, as most of the pre fabrication work could be done at existing Nigerian yards. This would not be possible in case of flexible risers as they are manufactured by contractors at their factories none of which is in Nigeria.

Since SCR is subjected to fatigue damage at hang off and TDZ so in the past it could not be used in deepwaters with FPSO. However the use of metallurgical clad pipes at the critical fatigue prone area of SCR allowed it to be used for first time in Bonga project. These pipes

had a layer of Inconel 825 alloy which was 3mm thick and was coated inside of conventional X65 pipe. These pipes had mechanical strength of X65 pipe and corrosion resistant properties of Inconel 825 thereby improving the resistance against fatigue due to sour service condition and permitting SCR to be used with FPSO in deepwater fields.

Key Identification: The key identification for offshore Nigeria is that majority of deepwater FPSOs have coupled riser concepts of which three are SCRs and one is free hanging flexible. Only one recently developed field (Usan) has used the uncoupled SHR concept.

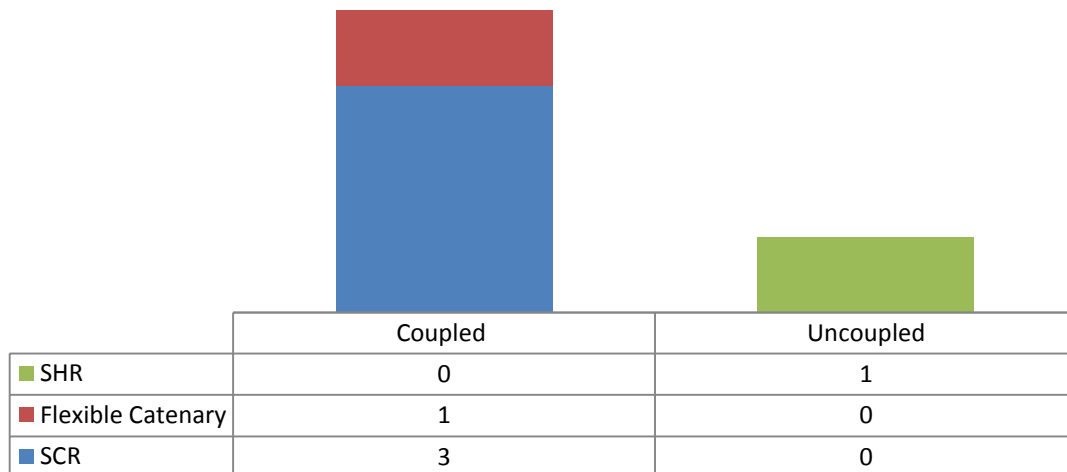

Figure 4.3 - Number of Deepwater FPSOs with their Riser Concepts in Offshore Nigeria

- **Angola:** Just like Nigeria the environmental conditions in Angola are benign and one directional, hence 70% of deepwater FPSOs are spread moored while the rest 30% have external turret. Also 50% FPSOs used coupled riser concepts (4 free hanging flexible riser and 1 lazy wave flexible riser), while rest 50% used uncoupled riser concepts (3SHR and 2 HRT).

HRT was first installed with FPSO in Girrasol field in 2001 and six years later it was installed in Rosa and Greater Plutonio. Till now only these three fields have utilized this uncoupled riser concept and another field being developed in the same region is CLOV which also utilizes 2 HRTs and 1 SHR.

SHR was first installed with FPSO Kizomba A in 2004 and a year later with FPSO Kizomba B. The same concept has been recently used in Angola with external turret FPSO PSVM at 2000m water depth.

The region also boasts of the world's first Integrated Production Bundle (IPB) which was installed for Dalia field in 2006. Five years later the same concept was used with Pazflor FPSO but in lazy wave configuration. The main advantage of IPB is to offer highly efficient active heating and temperature monitoring system for better thermal performance and flow assurance [Technip, 2013].

Key Identification: The key identification for offshore Angola is that the riser concepts installed with deepwater FPSOs are equally divided between coupled and uncoupled. Only this part of world uses HRTs with FPSOs in deepwater fields. This is due to mild

environmental conditions which allow HRTs to be towed to offshore site from the onshore construction site without significant fatigue damage as opposed to fields located in moderate and harsh environmental conditions.

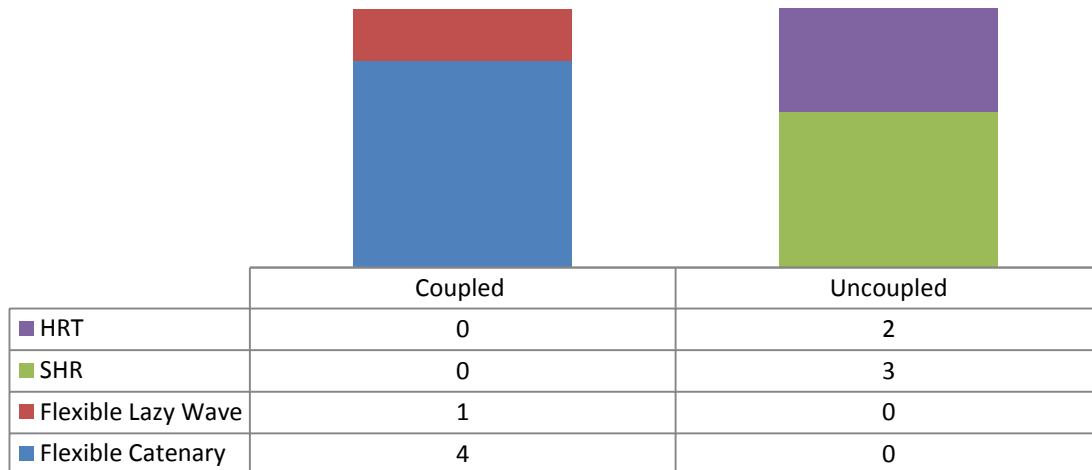

Figure 4.4 - Number of Deepwater FPSOs with their Riser Concepts in Offshore Angola

- **Rest of World:** Table 4.2 shows the number of deepwater FPSOs with their riser concepts in various locations.

Country	Coupled			Un Coupled
	Flexible Catenary	Flexible Lazy Wave	Flexible Pliant Wave	SHR
Cote d' Ivoire	1	0	0	0
Eq Guniea	1	0	0	0
Ghana	0	0	1	0
India	0	0	1	0
Italy	1	0	0	0
Malaysia	0	1	0	0
Mauritania	0	0	0	0
US GoM	0	0	0	1
West Australia	0	0	0	0

Table 4.2 - Number of Deepwater FPSOs with their Riser Concepts in Various Locations

Unbonded flexible riser in coupled configurations like catenary, lazy wave and pliant wave are dominant in rest part of the world. Only US GoM uses SHR concept which is connected to internal turret of the FPSO stationed at 2500m water depth in a location where frequent hurricanes come. At the time of extreme storms turret can be disconnected from FPSO thus bearing all the load of risers and moorings. Since a riser concept which would impose least amount of loads on turret during disconnection time was required, so the obvious choice for this situation was uncoupled SHR.

4.2.2 Mooring Type

Riser design and concept selection is also dependent on the type of mooring system used for station keeping of FPSO. Table 4.3 summarizes the data of Tabell 0.1 to show the relation between FPSO mooring and riser concepts.

Coupled					Uncoupled			Mooring Type
Catenary Flexible	Lazy Wave Flexible	Pliant Wave Flex.	SCR	SLWR	SHR	HRT	BSR	
11	2	-	3	-	3	2	2	Spread Moored -23
11	1	1	-	1	1	-	-	Internal Turret -15
6	2	1	-	-	1	-	-	External Turret -10

Table 4.3 - Number of Worldwide Deepwater FPSOs with their Riser Concepts and Mooring Type

Note: Table 4.3 depicts the number of deepwater FPSOs with a particular riser concept. For e.g. at present there are 3 FPSOs in the world which have SCR concept installed with it.

Spread Mooring: Table 4.3 clearly depicts that with spread moored FPSO both coupled and uncoupled riser concepts are used. Generally if small number of risers are to be connected to the spread moored FPSO then depending upon water depth and technical requirements coupled riser concepts like flexible /SCR can be used (as done in Agbami and Bonga respectively). However if the number of risers to be connected to the FPSO is large then uncoupled riser concepts like HRT/BSR can be used (as done in Girrasol and Guara Sapinhoa respectively). Table 4.4 compares the riser concepts which have been installed with spread moored FPSO.

Characteristic	Coupled Risers		Uncoupled Risers		
	Flexibles	SCR	SHR	HRT	BSR
Number of risers (low<10; high >12)	Limited by FPSO pitch/roll & layout	Limited by FPSO pitch/roll & layout	Limited by layout for large numbers	Possibility of large numbers	Possibility of large numbers
Thermal Insulation Requirements (OHTC)	Limited due to light weight (>3 W/m ² K)	Limited due to light weight (>3 W/m ² K)	Large (<3 W/m ² K)	Large (<3 W/m ² K)	Limited due to light weight (>3 W/m ² K)
Riser Load on FPSO	Large	Large	Small	Small	Small
Installation before FPSO arrival	No	No	Yes	Yes	Yes
Possibility for Future Expansion	Less	Less	More	More	More
Long Lead Components	Flexible Pipe	Flex joint	Flex joint	Flex joint	Tension System
Requirement for a Fabrication Yard	No	No	No	Yes	No
Local Content	Limited	Limited	Limited	Large	Limited

Table 4.4 - Comparison of Riser Concepts for Spread Moored FPSO [Marcoux and Legras, 2014]

Key Identification: The key identification for spread moored FPSOs is that both coupled and uncoupled risers can be used with it efficiently, however the former one takes the major share in water depths less than 1500m, as can be seen from Figure 4.5.



Figure 4.5 - Number of Spread Moored FPSO with its Riser Concepts (Worldwide)

Turret Mooring: Turret-moored FPSO generally allow better utilization of the seabed especially in deep water. Table 4.3 indicates that coupled risers are preferred over uncoupled risers however latter concept allowing larger vessel offset. For harsh weather environments turret moored FPSO having disconnecting capabilities is the preferred option and the only feasible option for such FPSO is uncoupled riser (as in Cascade & Chinook).

Table 4.5 compares the riser concepts which have been installed with turret-moored FPSO.

Characteristic	Coupled		Uncoupled
	Flexibles	SLWR	SHR
Number of risers (low<10; high >12)	Limited by FPSO pitch/roll & layout	Limited by FPSO pitch/roll & layout	Limited by layout for large number of risers
Thermal Insulation Requirements (OHTC)	Limited due to light weight (>3 W/m ² K)	Limited due to light weight (>3 W/m ² K)	Large (<3 W/m ² K)
Riser Load on FPSO	Large	Large	Small
Installation before FPSO arrival	No	No	Yes
Possibility for Future Expansion	Less	Less	More
Long Lead Components	Flexible Pipe	Flex joint	Flex joint
Requirement for a Fabrication Yard	No	No	No
Local Content	Limited	Limited	Limited

Table 4.5 - Comparison of Riser Concepts for Turret Moored FPSO [Marcoux and Legras, 2014]

Key Identification: The key identification for turret moored FPSOs is that coupled riser concepts are mostly used with turret moored FPSO in mild to moderate environments and water depths up to 1500m. However for harsh environments and water depths exceeding 1500m uncoupled risers can be used efficiently.

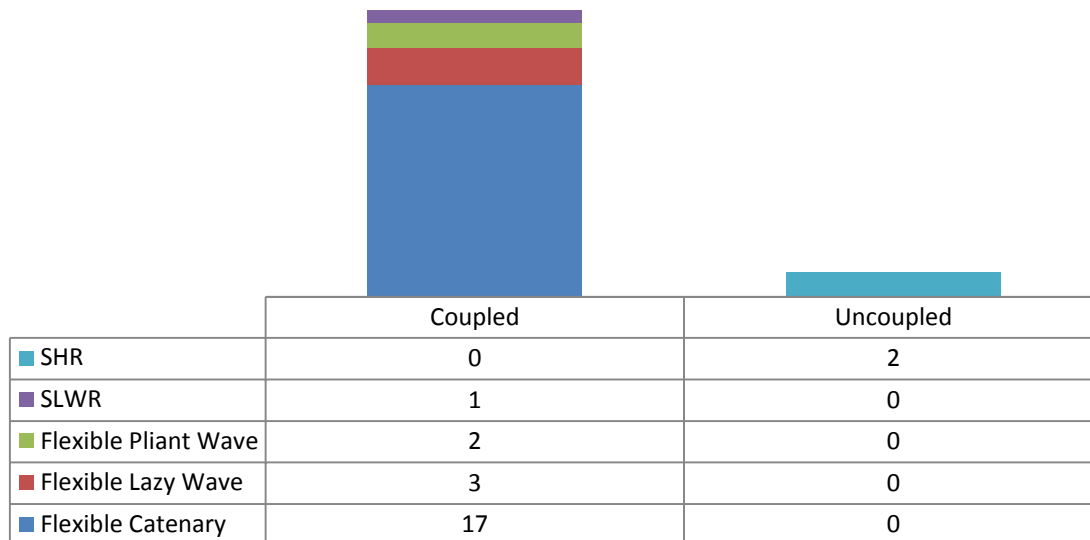

Figure 4.6 - Number of Turret Moored FPSO with its Riser Concepts (Worldwide)

4.3 Discussion and Conclusion

The key conclusions that can be made from the chapter are:

1. The data and discussion presented in this chapter indicates that variety of riser concepts have been used with FPSO in deepwater. While coupled riser concepts like free hanging flexible have dominated the field development in deepwater (<1500m) and moderate environments of Brazil, the riser concepts like SCR, HRT and SHR are mostly installed in benign environments of WoA.
2. Spread moored deepwater FPSOs have both coupled and uncoupled riser concepts hooked to it, while former one takes majority of the share in water depths less than 1500m.
3. Most of the riser concepts hooked to turret moored deepwater FPSO are of coupled nature.
4. It is hard to define the particular regions of application of the various riser concepts, since large number of factors affects its performance. It must be pointed that while making decision on the type of the riser system to be used FPSO it is important to consider all operational constraints and both Capex/Opex of the complete Floating Production System and not just of the FPSO.

Note: From chapter 4 it can be said that flexible riser, rigid metallic riser and hybrid riser are the concepts which have been used with deepwater FPSOs worldwide. Hence these riser concepts will be discussed next in detail in chapters 5, 6 and 7 respectively.

5. FLEXIBLE RISER

5.1 Definition and History

According to API Spec 17J “flexible riser is an assembly of a flexible pipe body and end fittings connecting a platform/buoy/ship to a flowline, seafloor installation or any other platform in various configurations like catenary or wave etc.” The same specification defines flexible pipe as “the pipe body comprising of layered materials that form a pressure-containing conduit and has ability to compensate large deflections without a significant increase in bending stress.”

The technology of flexible pipe was first used for transporting fuel way back during World War II. But first “un-bonded” flexible pipe to be used in offshore industry was developed by Coflexip (now Technip) in 1972, by using the patented technology of the Institut Français du Pétrole (IFP), France. IFP wanted to replace the conventional rigid drill pipe with the flexible hose which could sustain high pressures of 15000psi [Sparks, 2007]. But the attempts of IFP to use novel pipe technology for flexible drilling system failed and it gave the offshore oil and gas industry a new concept of flexible pipe which could be used for static (flowline) and dynamic (riser) application. The key historical milestones for flexible riser are presented in Table 5.1.

Flexible Type	Area of Application	Year	Reference
Riser	World’s first dynamic riser, in Enchova field, offshore Brazil.	1977	Fraga et al, 2003
Riser with Heat Tracing	First flexible riser with heat tracing on Conoco’s Udang field in Indonesia.	1978	Technip Brochure, 2013
Lazy Wave Riser	First Lazy Wave flexible riser configuration used on the Conoco’s Geisum field, offshore Egypt.	1986	Tillinghast et al, 1987
Riser	First dynamic flexible riser system installed on Balmoral field in UK North Sea.	1986	Technip Brochure, 2013
Riser	First use of flexible riser in Norwegian sector of North sea with FPSO Petrojarl1 in Oseberg.	1986	Gisvold, 2006
IPB Riser	First installation of novel Integrated Production Bundle (IPB) risers at WD of 1360m on Total’s Dalia field in Angola	2006	Technip Brochure, 2013
Smoothbore Riser	First installation of Smoothbore risers on Statoil’s Åsgard field in Norwegian Sea	2007	Technip Brochure, 2013

Table 5.1 - Historical Milestones of Flexible Pipe

In 1970s flexible risers were primarily used for moderate environments of offshore Brazil, but by 1980s they were also being used in harsh environments prevailing in North Sea. Figure 5.1 shows the number of flexible risers installed worldwide from period 1995 to 2005, which depicts the dominance of flexible pipe technology in offshore industry.

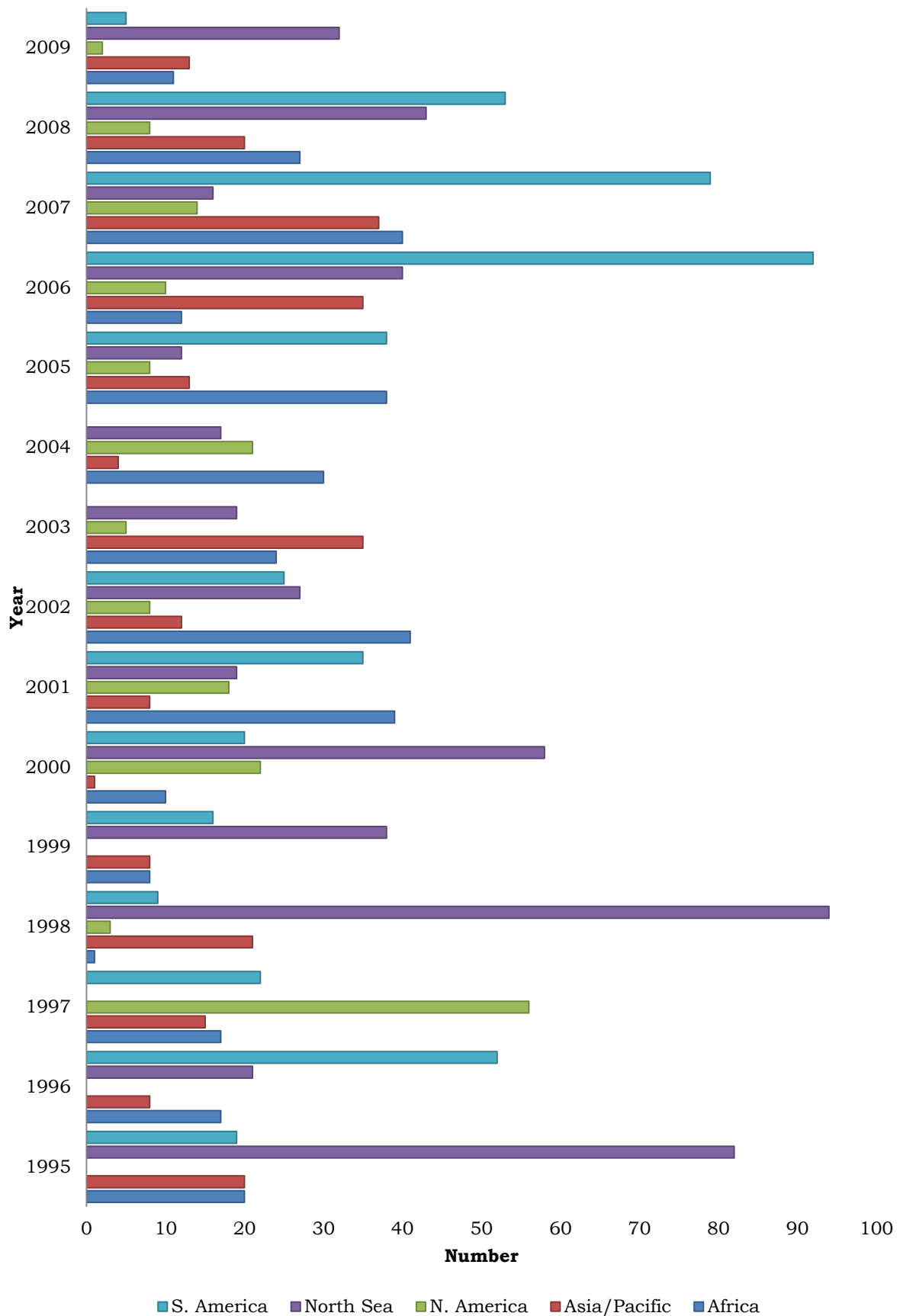

Figure 5.1 - Year vs Number of Flexibles Installed [Offshore Magazine, November 2010]

Figure 5.1 clearly depicts that South America (Brazil) and North Sea have dominated in the use of flexible riser technology.

The first use of flexible pipe on Norwegian Continental Shelf (NCS) was as a flowline on the seabed in 1986. In the same year flexible riser connected to FPSO Petrojarl1 marked the beginning of flexible riser industry in NCS. This was followed by their use as risers which connected the subsea infrastructure to the Snorre TLP in year 1992 [4Subsea, 2013]. Since then these have been widely used as risers in NCS with 326 of them installed till 2013 as can be seen from Figure 5.2.

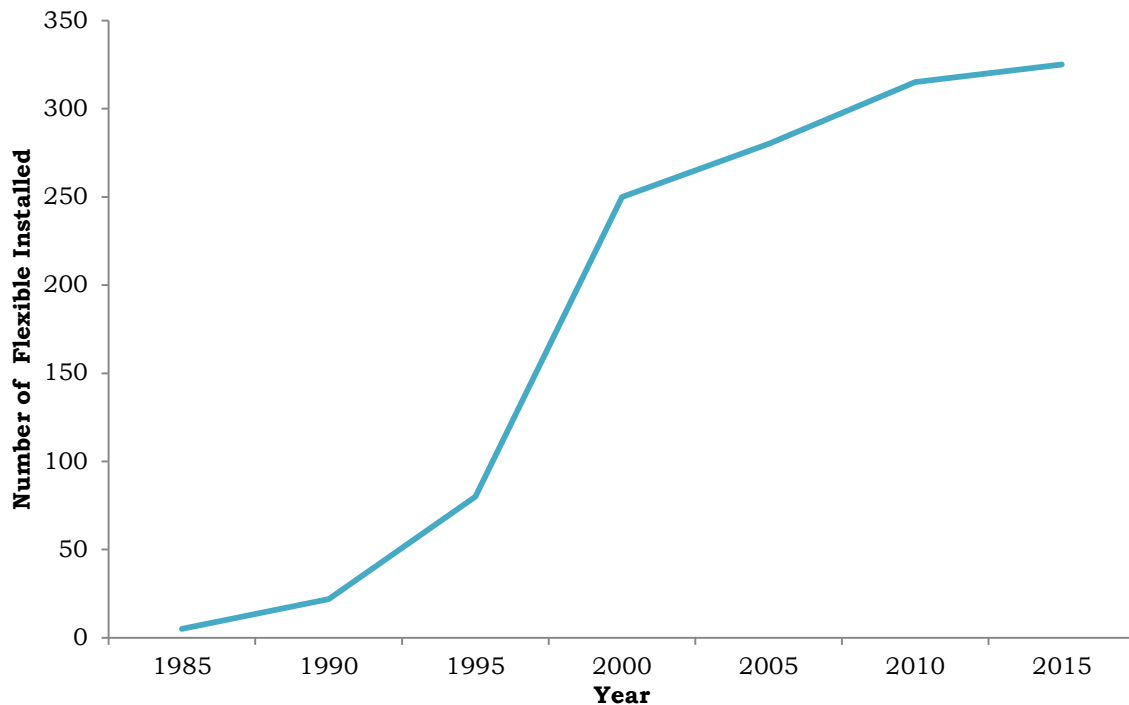

Figure 5.2 - Cumulative Number of Flexible Risers Installed in NCS [4Subsea, 2013]

From Figure 5.2 it can be seen that flexible risers were first installed in Norwegian sector of North Sea in 1986. Ever since then the number of flexible riser installation has increased with most prolific growth occurring from period 1995 to 2000. However it must be noted that most of the risers installed in Norwegian sector of North Sea are in water depth less than 600m.

Till 2010 three main suppliers of flexible pipe namely Technip, Wellstream and NKT had installed 9500, 2500 and 1500km of flexible pipe worldwide respectively [4Subsea, 2013].

5.2 Configuration

Flexible risers when used with FPU's must have a configuration which should be compliant enough to absorb floater motions without the use of heave compensation system [DNV-OSS-302, 2003]. The factors which influence design of configuration are water depth, hang-off location, field layout, ID requirement, minimum service life, mooring layout, environmental data and the host floater motion characteristics [Bai & Bai, 2005].

In offshore industry flexible risers can be installed in variety of configurations as depicted in Figure 5.3.

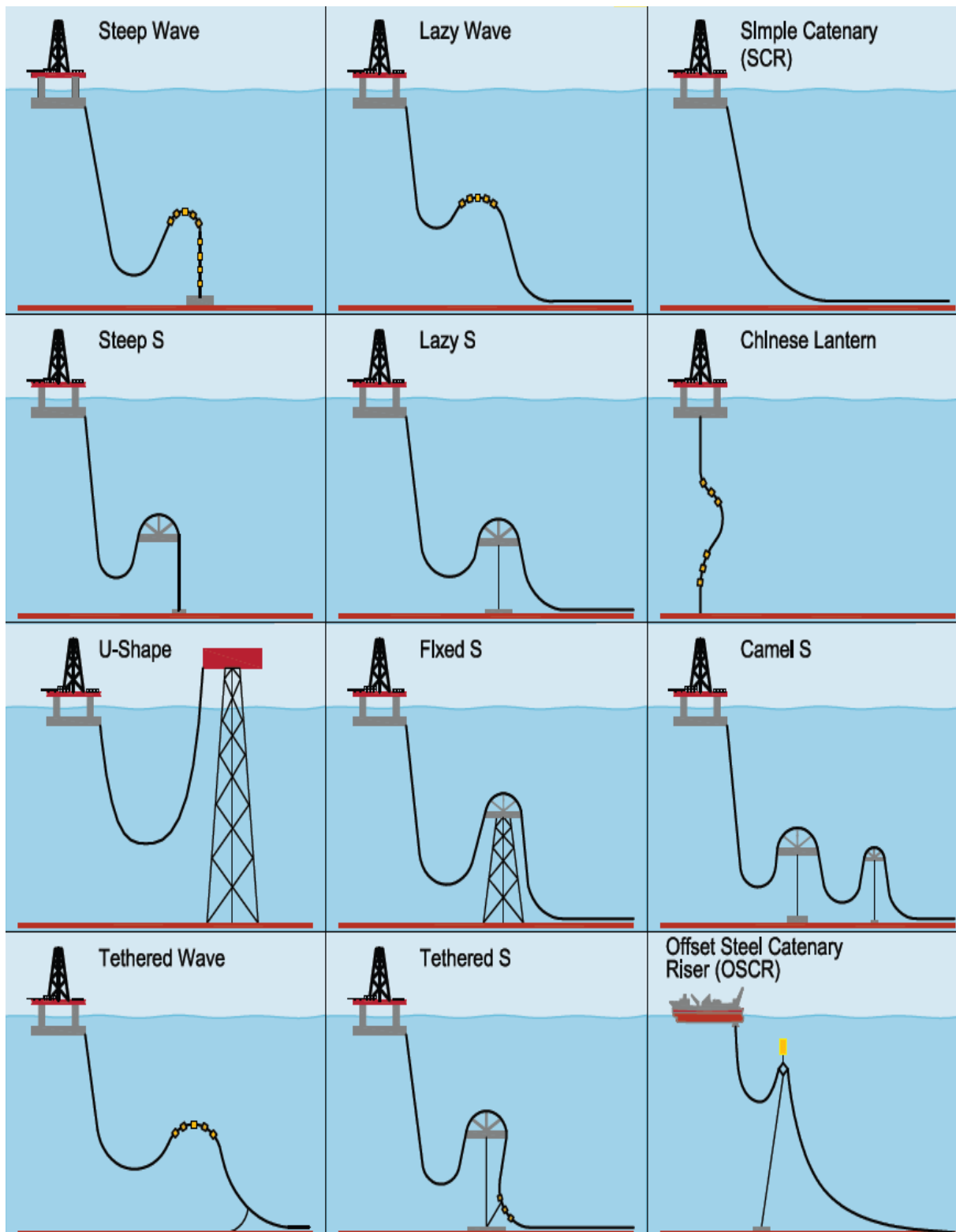

Figure 5.3 - Flexible Riser Complaint Configurations [Offshore Magazine, November 2010]

The complaint configurations have ability to change their geometry in order to accommodate the host vessel offsets. Based on discussion in chapter 4 of this thesis, it can be said that for FPSO stationed in deepwater only three configurations namely free hanging, lazy wave and pliant wave have been used. Each one of these are discussed separately next.

5.2.1 Free Hanging Catenary

As defined in API RP 17B “Riser configuration that spans the water column in a catenary shape modified by the bending stiffness of the riser.” This configuration is easiest and cheapest to install as least amount of subsea infrastructure is required for this configuration. Owing to these benefits this is a suitable configuration for deepwater FPSO stationed in mild to moderate environments. As an example 16 flexible risers are hanging freely from the porch of spread moored FPSO Agbami stationed at 1462m in WoA.

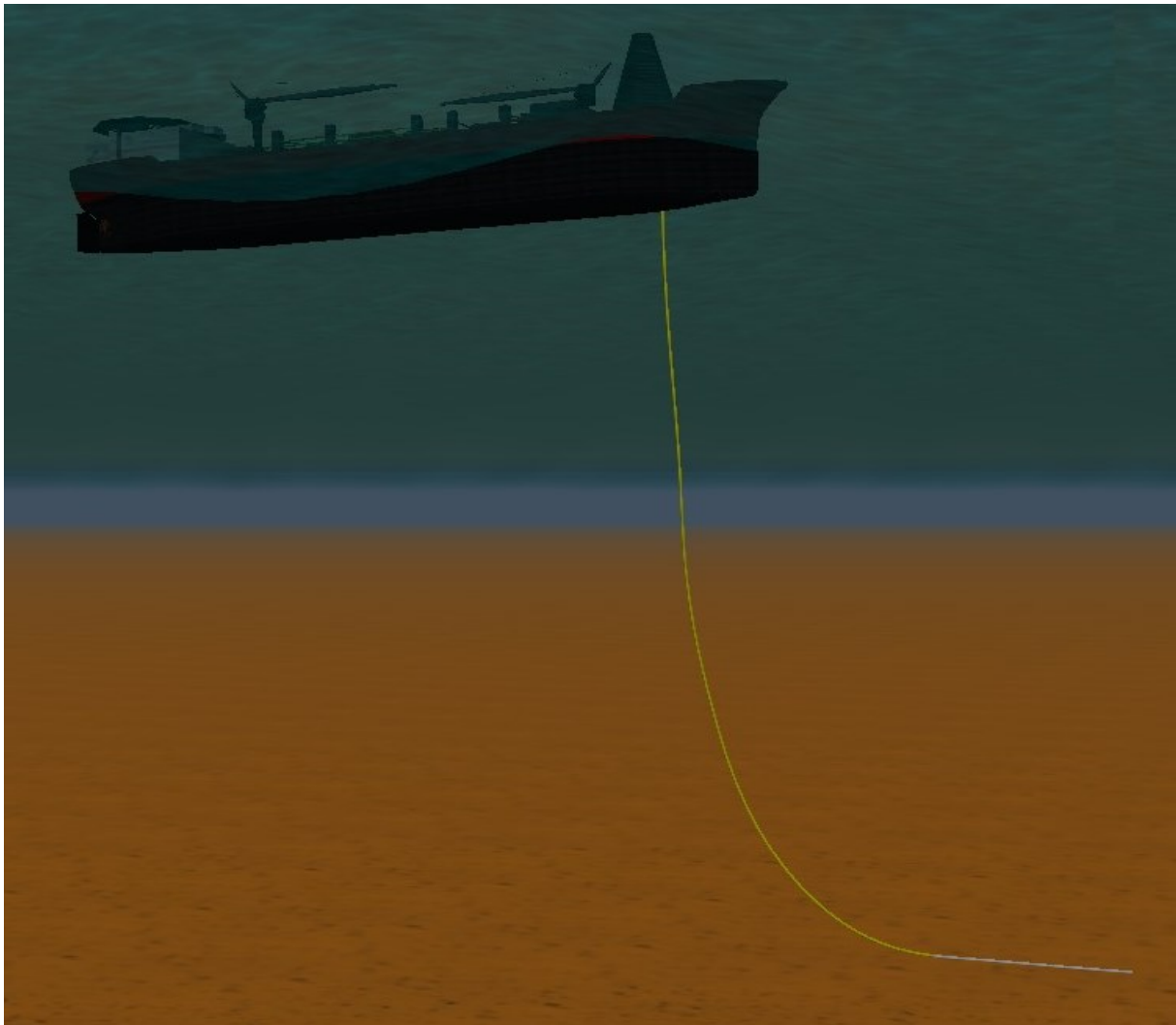

Figure 5.4 - Free Hanging Riser Configuration

Advantages:

- Simple concept with minimal subsea infrastructure.
- Easy and cheap to install.

Disadvantages:

- Lower fatigue life and high bending stress at TDP.
- High vessel payload.
- Possibility of steel tensile armor “birdcaging”.
- High top tension requirements in deepwater.
- Possibility of snatch loads at TDP.

5.2.2 Lazy Wave

As defined in API RP 17B “Free hanging catenary modified by a section with distributed buoyancy modules.” Since in harsh environments free hanging catenary is not feasible so it becomes necessary to decouple the host vessel response from the riser portion at seabed interface by employing distributed buoyancy modules along the specified length of the riser. This is one of the preferred configurations for deep waters as it allows vessel offsets up to 30% of water depth.

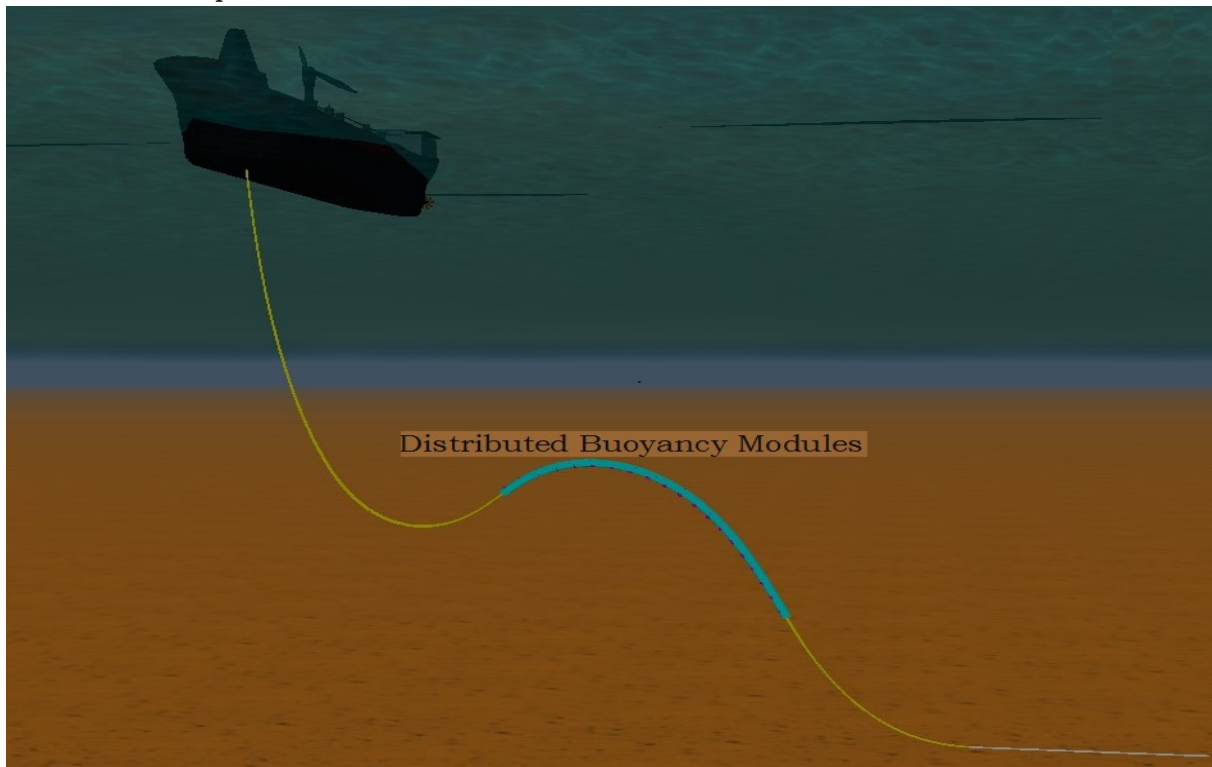

Figure 5.5 - Lazy Wave Riser Configuration

Buoyancy modules are made from syntactic foam which have low water absorption ability. However with the passage of time it loses its buoyancy hence the wave configuration is made more compliant to accommodate for 10% loss of buoyancy due to buoyancy modules [Bai & Bai, 2005].

Advantages:

- Due to decoupling of vessel motions from Touch Down Zone (TDZ) of riser, the fatigue life of riser at TDP is improved and vessel payload is reduced.
- Preferred to Steep Wave as it requires minimum structures on seabed.
- More compliant than Lazy S-configuration, which makes it suitable for harsher environments as it allows larger vessel offsets. [Anderson and Connor, 2012].

Disadvantages:

- Expensive than free hanging catenary due to usage of buoyancy modules.
- Configuration changes considerably with the change in bore content density.
- The probability of riser clashing increases in case of large transverse currents. In order to prevent clashing of adjacent risers and buoyancy modules the heading between them should be approximately 10 degree. This heading requirement puts a restriction on number of risers that can be adjusted with the mooring system [Anderson and Connor, 2012].

5.2.3 Pliant (Tethered) Wave

It is a Lazy Wave which is tied back to the subsea well located below the host vessel. Contrary to lazy wave in which the tension of the riser is transferred to the TDP, this configuration utilizes tether and anchor to take all the riser tension from its TDP.

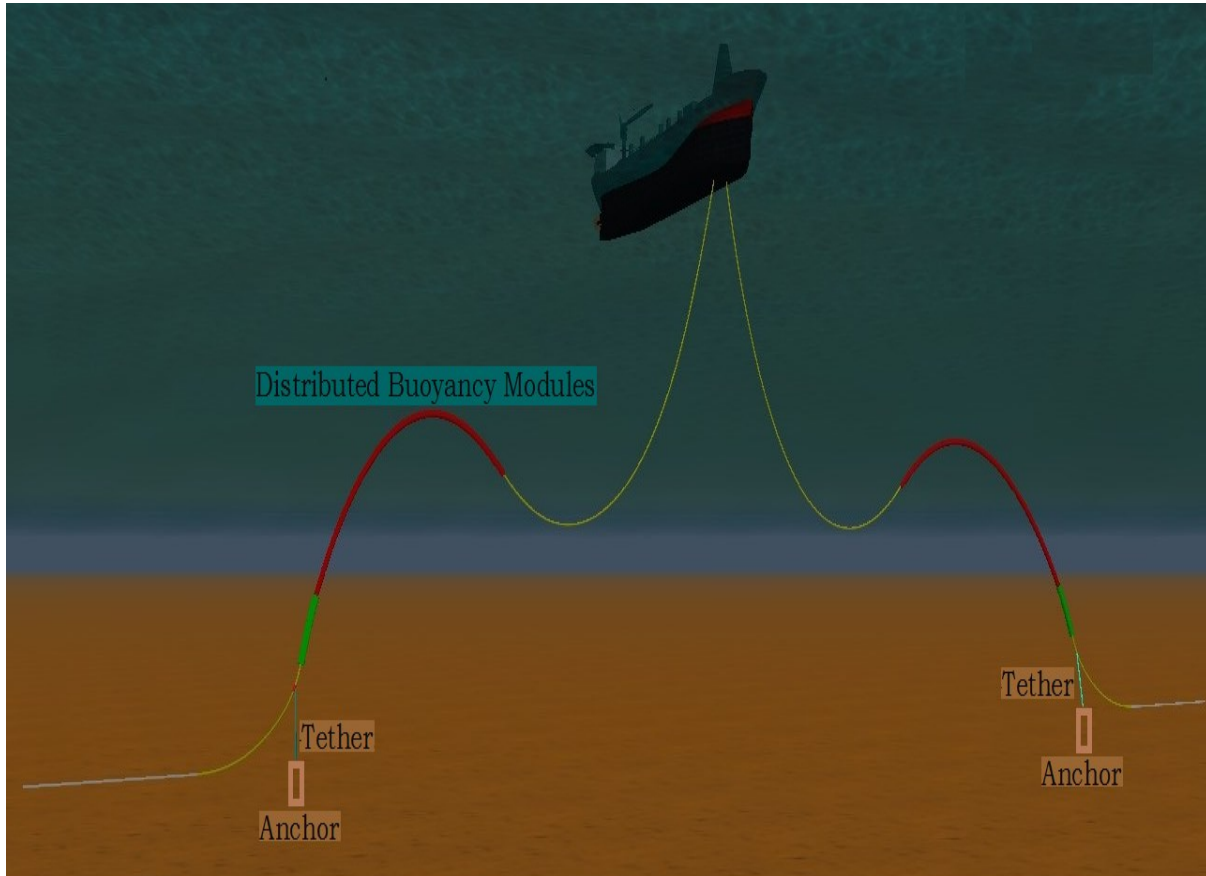

Figure 5.6 - Pliant Wave Riser Configuration

Advantages:

- It allows use of variety of liquids having different density as it is less prone to change in bore content density when compared to Lazy Wave [Bai & Bai, 2005].
- It also permits large vessel motions without overstressing of the riser.
- The fatigue life at TDP is improved as the vessel motion is transferred to tether.
- Less vessel payload.
- It does not require bend stiffener and separate riser base as it is connected directly to the well.
- Well intervention can be done through host vessel as the riser is connected to the subsea well located in close vicinity of the vessel.

Disadvantages:

- Installation and formation of configuration is complex.
- Challenge is faced to control the curvature of the riser at the position where it is tethered to the anchor.
- Requires additional tethering arrangement and clamp which adds to cost and installation complexity. Hence should be used only when other configurations are not possible.

5.3 Construction

The mechanical performance of a flexible riser is dependent on the way various layers in its wall interact with each other. If the different layers of pipe are bonded to each other such that no relative motion exists between them then it is called as bonded pipe. However if the pipe is having separate layers of metal and polymers which are allowed to have a relative motion between them, then it is called as unbonded pipe. These are discussed separately with more details on unbonded metallic pipes since these are mostly used in offshore industry.

5.3.1 Bonded Metallic Pipe

This pipe was standardized between 1996 to 2002 by API Spec 17K which defines it as “a flexible pipe where the steel reinforcement is integrated and bonded to a vulcanized elastomeric material. Textile material is included in the structure to obtain additional structural reinforcement or to separate elastomeric layers.” The structure of typical bonded pipe is shown in Figure 5.7 while Figure 5.8 shows its coupling.



Figure 5.7- Cross-section of Bonded Flexible Riser [Antal et al, 2003]



Figure 5.8 - Cross-section of Coupling Used with Bonded Flexible Riser [Antal et al, 2003]

The bonded pipes which follow specifications of API 17K can be used for transporting liquids like water, oil and for gases as well. These are generally used as jumpers and offloading lines in small lengths. Since this type of pipe has a limited scope as deepwater riser so it will not be discussed further.

5.3.2 Unbonded Metallic Pipe

In this pipe there are different layers of steel and polymer which are not bonded to each other and allow relative movement between them. This pipe was standardized between 1994 to 1997 by API Specification 17 J and it is constructed in a way to have low bending stiffness coupled with high axial tensile stiffness. Because of its high bending flexibility it can be wound on to reels with typical core diameter of 3-5m and OD of 9-10m which facilitates its storage, transportation and installation [Andresen et al, 2005].

Generally, flexible pipe is a tailored product which can have different layer combinations for the composite wall, depending upon its application. However API RP 17B has tried to standardize this by defining three flexible pipe families which have different composite wall structure as can be seen from Table 5.2.

			Product Family I	Product Family II	Product Family III
Layer Num.	Structural Layer	Layer Function	Smooth Bore Pipe	Rough Bore Pipe	Rough Bore Reinforced Pipe
1	Internal Carcass	Prevent Collapse			
2	Internal Pressure Sheath	Internal Fluid Integrity			
3	Pressure Armour	Hoop Stress Resistance			
4	Intermediate Sheath	External Fluid Integrity	Optional		
5	Tensile Armour	Tensile Stress Resistance			
6	Outer Sheath	Mechanical Protection			
Color Code Legend					
Layer is Present			Layer is Absent		

Table 5.2 - Classification of Standard Unbonded Flexible Pipe [API RP 17B, 2008]

The typical cross-section of different unbonded flexible pipe classes is shown in Figure 5.9.

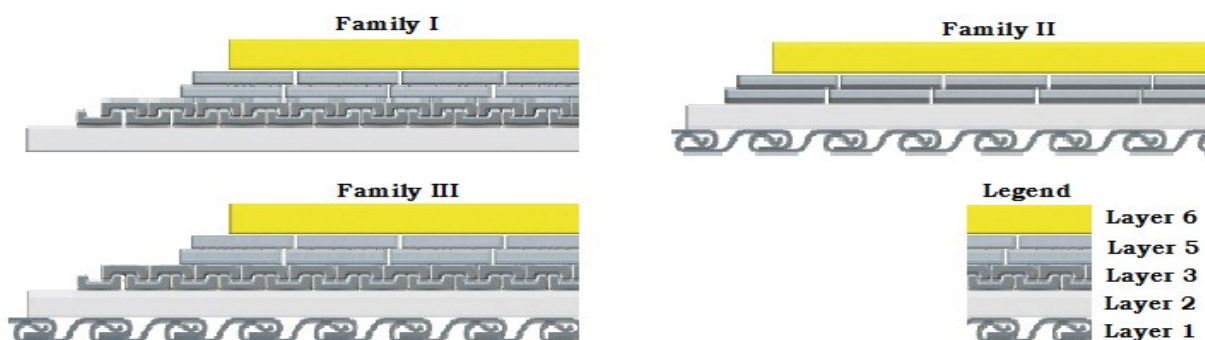

Figure 5.9 - Cross-section of Family of Unbonded Flexible Riser [NKT Flexibles Boucher, 2012]

Besides the main layers shown in Figure 5.9, additional layers like tapes, anti-wear and thermal insulation may be present in the composite wall structure of the flexible pipe, depending upon project specific needs. Figure 5.10 shows various layers of a typical unbonded flexible riser.

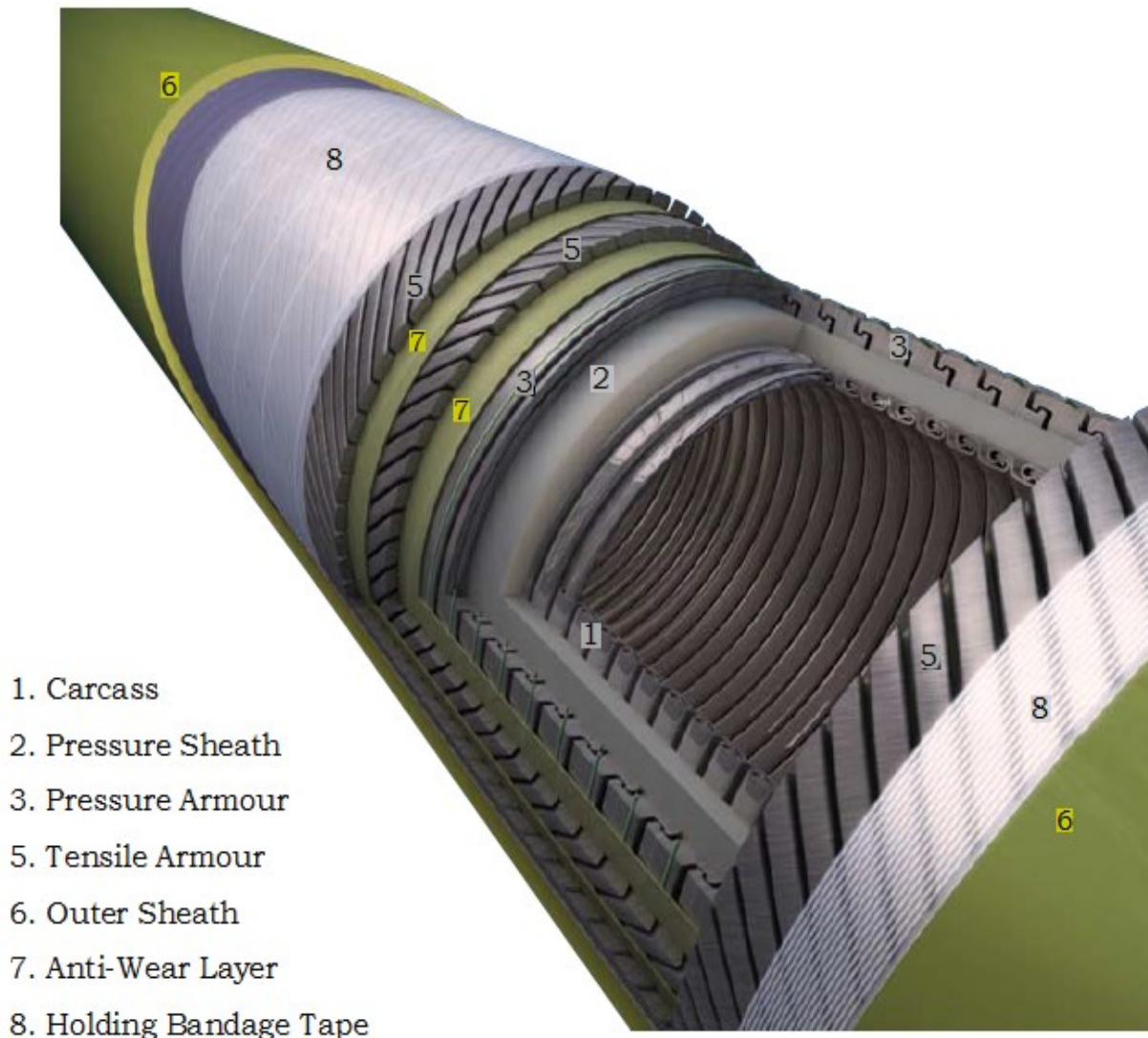

Figure 5.10 - Cross-section of Family III Flexible Riser [NKT Flexibles Boucher, 2012]

Various layers along with their functions are defined below:

Layer 1 - Carcass: “An interlocked metallic construction which forms the innermost layer of rough bore pipes and provides it with the necessary support in radial direction to resist external loads.” Thus this layer provides the necessary collapse resistance to withstand external loads arising due to crushing and hydrostatic pressure.

The pipe having carcass as innermost layer is termed as roughbore pipe/riser and the conventional carcass is an interlocked strip which is obtained by cold forming of flat stainless strip. However when flexible riser is to be used in deepwaters then the conventional carcass is replaced by K-profile carcass as shown in Figure 5.11. This profile has much higher radial compression capacity which enormously increases its collapse resistance and makes it suitable for deepwater application [Nielsen et al, 2011]. The

additional benefit of K-profile carcass is that it alleviates the singing phenomenon previously experienced by flexibles having conventional carcass used for transporting dry gas.



Figure 5.11 - Structure of Conventional Carcass and K-Profile Carcass [Nielsen et al, 2011]

The material of the carcass depends upon the required corrosion resistance and varies from grades AISI 304L/ AISI 316L for less corrosive environments to duplex/super duplex for highly corrosive environments [Andersen et al, 2005]. Table 5.3 shows the composition of various steel grades used for manufacturing of carcass [Palmer and King, 2004].

Material	Composition (maximum %)					Mechanical Properties
	Carbon	Manganese	Nickel	Chromium	Molybdenum	UTS (Mpa)
4130 CS	0.33	0.9	-	0.8-1.2	0.15-0.2	621
304 SS	0.03	2	8 -10	17-19	-	540
304L SS	0.03	2	9 -11	17-19	-	490
316 SS	0.07	2	10 -12.5	16-18	2-2.5	560
316L SS	0.03	2	10.5 -13	16-18	2-2.5	510
Duplex SS	0.03	0.2	4.5 - 6.5	21-23	2.5-3.5	790

Table 5.3 - Characteristics of Typical Carcass Materials [Palmer and King, 2004]

However carcass is not present in all the flexible pipe structures and the minimum Gas Oil Ratio (GOR) beyond which it is considered obligatory is 300 [Palmer and King, 2004]. The pipe thus formed without carcass as its innermost layer is termed as smoothbore and finds its use for transporting stabilized crude and water injection. The first smoothbore riser was manufactured by Technip for Åsgard field in the year 2006. The novel design not only eliminated the singing and vibration issues in the initially installed roughbore riser but it also mitigated the pressure losses [Crome et al, 2007].

Layer 2 - Internal Pressure Sheath: “A polymeric layer which acts as a leak proof barrier and provides internal fluid integrity.” Generally it is an extruded single layer but it can even be multi layered with extra layers acting as sacrificial layer and thermal barriers. The most commonly used polymer for manufacturing it includes particular grades of polyethylene (HDPE), polyamide (PA11) materials and polyvinylidene fluoride (PVDF) materials with maximum allowable design temperatures of 65, 95 and 130 degree Celsius [Andersen et al, 2005].

Table 5.4 shows features of the typical materials used to manufacture inner pressure sheath.

Material	Density (kg/m ³)	Thermal Tolerance (degree C)	Thermal Conductivity (W/m degree C)	Tensile Strength (MPa)	Bending Modulus (MPa)
Nylon 11	1050	Oil - 100 Water - 65	0.33	350	300
HDPE	940	Water - 65	0.41	800	700
Fluorocarbon	1600	Oil - 130	0.19	700	900
PVDF	-	Water - 130	0.19	700	900

Table 5.4 - Characteristics of Typical Inner Pressure Sheath Materials [Palmer and King, 2004]

Layer 3 - Pressure Armour: “An interlocked metallic construction which provides the necessary strength in radial direction to withstand loads due to internal fluid and external factors (hydrostatic and crushing).” If the inner carcass has tendency to fail at higher buckling modes then this layer can be designed to increase the collapse resistance of the pipe thereby preventing the carcass failure.

The layer also structurally supports the internal-pressure sheath and armor wires have a lay angle close to 90 degrees [API Spec 17J, 2008]. Generally the material of armor wires are various low-alloy carbon steel grades having yield strength in range of 800 to 1000MPa [Andersen et al, 2005]. The armor wires can be interlocked to each other in three shapes namely C, T and Z as shown in Figure 5.12.

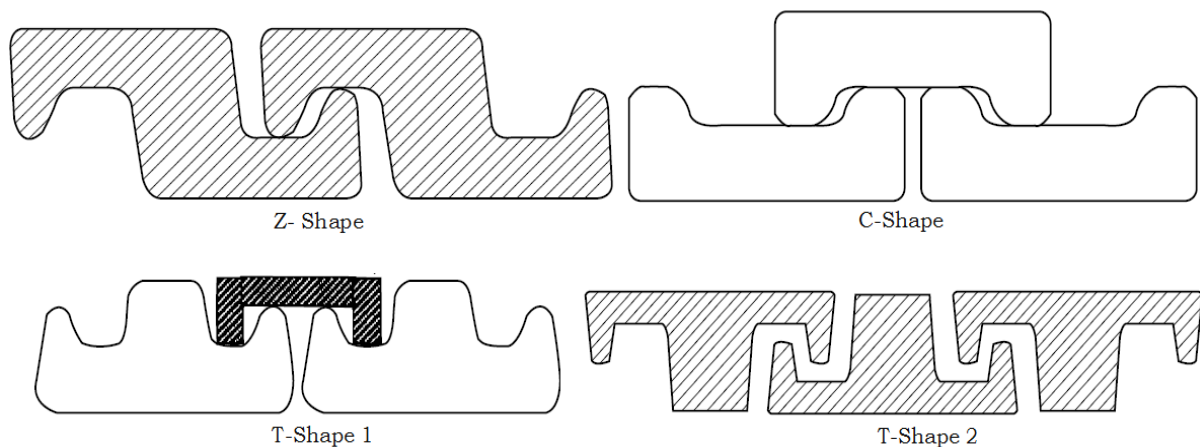

Figure 5.12 - Typical Pressure Armor Profiles Used in Unbonded Flexible Pipe [API RP 17B, 2008]

Initially, the pressure armor had a Z-shaped cross-section and it was termed as Zeta spiral. However, Coflexip proposed new hoop spiral wire geometry called as T-wire or Teta spiral which is less vulnerable to fatigue crack initiation than the Zeta spiral. With T-wire profile larger and stronger hoop spirals can be made which will enable dynamic risers to be used in higher pressure and deeper water [Offshore Magazine, January 2012]. But Teta spiral tends to increase the weight of riser their by increasing vessel payloads and top tension requirements.

The C-shaped profile was developed by a cable manufacturer named Furukawa from Japan and is now used by NKT Flexibles since 1996 [4Subsea, 2013].

Layer 4 - Intermediate Sheath: As stated in API Spec 17J “it is an extruded polymer layer located between internal pressure and outer sheaths, which may be used as a barrier to external fluids in smooth bore pipes or as an anti-wear layer”. The main purpose of this layer is to allow the pipe to be installed in empty conditions [Andersen et al, 2005].

Layer 5 - Tensile Armor: “An interlocked metallic construction, which provides the necessary tensile strength in axial direction to withstand all kind of tensile loads. The tensile loads may occur due to riser weight, end cap effects or external sources”. The metallic wires have a lay angle typically between 20 degrees and 55 degrees, and generally have a rectangular cross-section, but sometimes depending upon the needs round or profiled wires may be used [API Spec 17J, 2008].

The wires are cross wound in pairs so that axial tension and pressure do not generate enormous twisting in pipe. Generally the material of armor wires are various low-alloy carbon steel grades having yield strength in range of 700 to 1500Mpa [Andersen et al, 2005]. These wires are welded to end fitting in an electrically conductive manner in order to ensure that the Cathodic Protection (CP) system protects the entire pipeline length from being corroded.

Layer 6 - Outer Sheath: According to API Spec 17J “it is a polymer layer used to protect the pipe against penetration of seawater and other external environments, corrosion, abrasion and mechanical damage, and to keep the tensile armors in position after forming.” It is normally made from the extrusion of specific grades of polyethylene(MDPE) or polyamide (PA 11) materials with former one being used for static applications while the latter is used for dynamic applications [Andersen et al, 2005].

In case of damage to outer sheath it is necessary to prevent the corrosion of the underlying steel wires. This is achieved by using a cathodic protection (CP) system which consists of number of bracelet anodes on the pipe near the end fitting which are electrically connected together as shown in Figure 5.13 [Palmer and King, 2004].

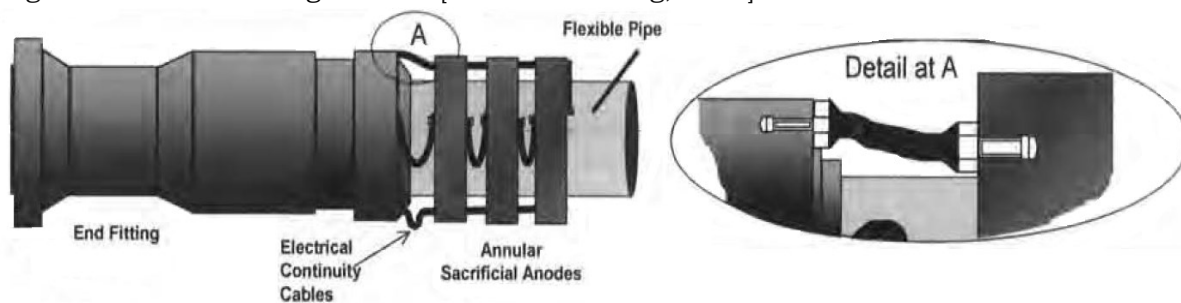

Figure 5.13 - Typical CP System of Flexible Pipe [Palmer and King, 2004]

Layer 7 - Anti-Wear Layer: “A non-metallic layer which is placed between various metallic layers of the riser to prevent their abrasion and thereby improving fatigue life of the riser”. These are 1mm to 3mm thick and are typically made from polymeric tapes (PA & or PA 11) [Andersen et al, 2005].

Layer 8 - Holding Bandage Tape: This layer is a typical fiber reinforced polymer tape generally wound around the outer tensile layer with high lay angle for risers operating in deepwater. Its main purpose is to keep the radial movement of the tensile armor in specified limits [Andersen et al, 2005].

5.3.3 Unbonded Hybrid Composite Pipe

The conventional unbonded metallic flexible pipe when used in free hanging configuration in water depths greater than 1500m tend to be very heavy thus inducing high top tension loads which becomes a critical issue for installation vessel and the FPU. One way to reduce top tension at such depths is to replace simpler free hanging configuration with more expensive lazy wave configuration by using number of buoyancy modules.

Another way is to use hybrid flexible riser having Carbon Fibre Armors (CFAs) in place of steel armored flexible pipe. CFA offers dual benefits of being resistant to H₂S and higher strength to weight ratio when compared to steel armors, thus making it suitable for sour service fields in deepwater.

Industrious Research and Development (R&D) in Carbon Fibre Composite (CFC) material has shown that it is 5 times lighter and it has 2 times higher resistance when compared to high strength steel as shown in Table 5.5.

Armor Material	Ultimate Tensile Strength (UTS)	Percentage Elongation at Break	Modulus of Elasticity	Density
High Strength Carbon Steel	≤1400MPa	≥5	210GPa	7.8
Sour Service Steel	≤850MPa	≥10	210GPa	7.8
Carbon Fibre Composite	≥3000MPa	≥1.8	160GPa	1.7

Table 5.5 - Comparison of Various Materials Used for Making Tensile Armor [Do & Lambert, 2012]

Due to higher UTS and lower density, the specific strength (ratio of UTS to Density) of CFC is also much higher than the various steel grades used for the construction of steel armor, as can be seen in Figure 5.14.

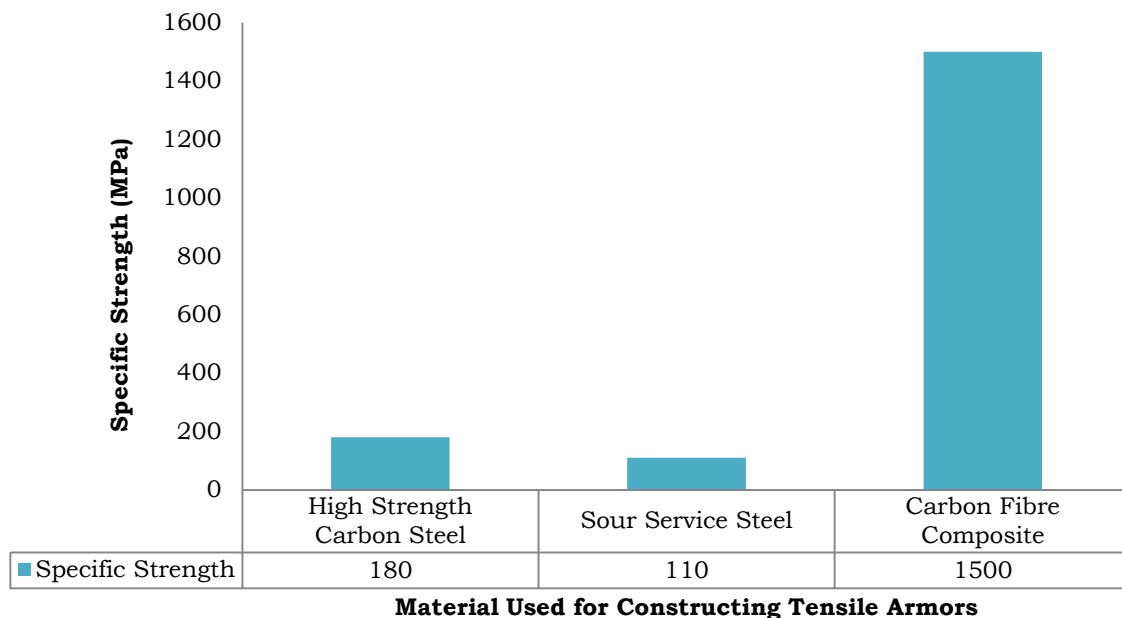

Figure 5.14 - Specific Strength of Materials Used for Making Tensile Armor [Do & Lambert, 2012]

The higher specific strength makes CFC material a suitable alternative to be used in place of steel for constructing tensile armors for flexible riser which can be used as free hanging catenary configuration even in ultra-deep water field developments. The free hanging CFA flexible riser consists of 2 parts, with the top part made of composite riser while rest of the

riser section made from conventional steel armored flexible riser [Do & Lambert, 2012]. The reason of doing so is due to inability of CFA material to withstand compressive loads which are enormous on the seabed.

Though at present the price of composite material is much higher than steel, but the overall cost of CFA riser free hanging configuration is less than the conventional riser in lazy wave configuration. This can be accounted to absence of the buoyancy modules in the former riser system, which however are inherently used in latter riser system to give the desired wave shape. It must be mentioned here that free hanging CFA risers also come with ease of installation when compared to lazy wave configuration of steel armored flexible risers.

The design philosophy and design criteria for composite risers are discussed in DNV-RP-F202 which also discusses its analysis methodology. The basic structural layers of the composite riser are similar to conventional riser, with the only difference of steel armor being replaced by Carbon Fiber Armor as shown in Figure 5.15.

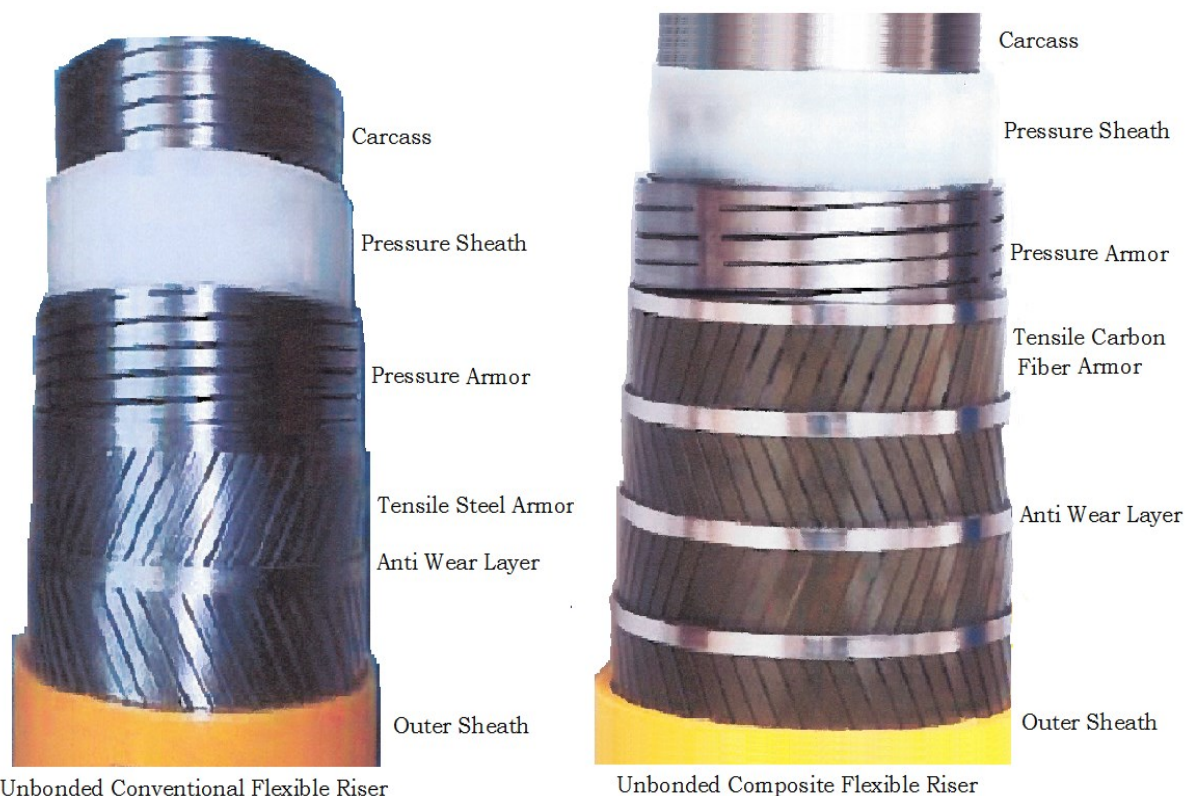

Figure 5.15 - Comparison of Typical Cross-section of Flexible Riser [Bernard et al, 2013]

The advantages offered by CFA flexible riser over steel armored riser can be summarized as:

- Lighter weight
- Better fatigue performance
- High resistance to corrosion
- Easy to install
- Higher strength to weight ratio
- Suitable for sour service conditions.

Owing to these advantages CFA riser seems to be promising alternative for deep and ultra-deep waters.

5.3.4 Unbonded Nonmetallic Pipe

This is a DeepFlex patented product which replaces metallic reinforcement in conventional unbonded metallic pipes with the extruded layers of polymer which is in turn reinforced with unbonded laminated glass fiber tape [Bryant et al, 2007]. The commercial name for this pipe is Flexible Fiber Reinforced Pipe (FFRP®) and it has following advantages over the conventional flexible pipe:

- High resistance to corrosion.
- Better fatigue performance.
- Superior flow assurance as pressure drop is less.
- Resistant to H₂S and CO₂.
- Ability to withstand higher pressure and temperature.
- Ability to construct in long continuous lengths.
- Better thermal performance as U-value is 30% lower than conventional pipe [Bryant et al, 2007].
- Combination of high strength and low weight allows it to be installed beyond 3000m.
- Less weight means less vessel payloads and less installation cost.

This patented product comes in two structure categories namely Standard FFRP and Free venting FFRP. The former one is generally used for water injection application while the later one is used as a production riser. Figure 5.16 shows typical structure of the free venting FFRP.

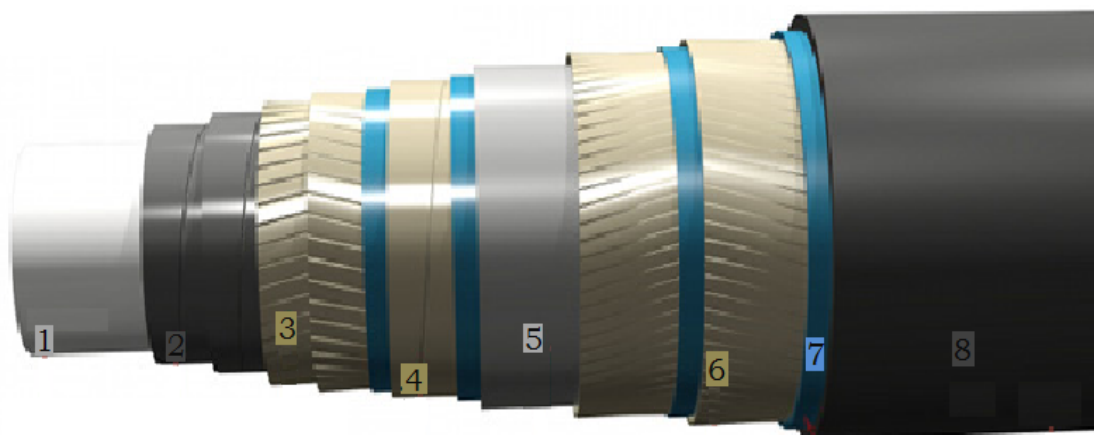

- | | |
|---------------------------------|-----------------------------------|
| 1. Liner Extrusion | |
| 2. Anti-Extrusion Layer | |
| 3. Pressure Reinforcement Layer | 6. Pressure/Tensile Reinforcement |
| 4. Hoop Reinforcement | 7. Anti -Wear Layer |
| 5. Membrane Extrusion | 8. Jacket Extrusion |

Figure 5.16 - Typical Cross-section of Flexible Fiber Reinforced Pipe [Bryant et al, 2007]

FFRP is a novel concept which suits the deepwater industry but right now there are no standards and codes dedicated to this product. However circa January 2012 DeepFlex and Petrobras have joined hands to perform a qualification testing program of this pipe which is being witnessed and certified by DNV. Also Annex H has been added to draft of 5th edition of API RP 17B which is expected to be out later this year [Kalman et al, 2013].

5.4 Components

For proper functioning of the riser system, different kinds of components are used along with the flexible riser pipe. These components ensure that the riser system fulfills its design criteria during all the operations and performs its desired function of transporting fluid without failure. Figure 5.17 shows typical topside head of flexible riser.

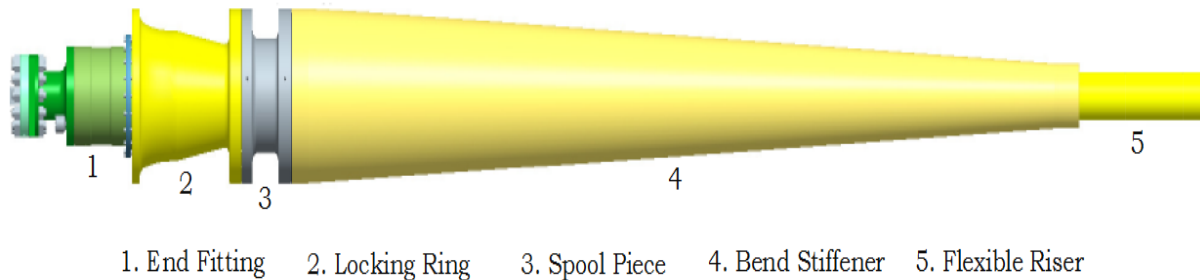

Figure 5.17 – Typical Topside End Termination of Flexible Riser [NOV, 2013]

Depending upon the riser configuration following components may become the part of the riser system:

5.4.1 End Fitting

Irrespective of which type of unbonded flexible riser is used to transport fluid between seabed and FPU, there is always a requirement of a mechanical device which acts as an interface between flexible riser body and rigid connector which is called as end fitting. It is a special tailored device whose design and construction depends upon the family of flexible riser with which it is to be used. Irrespective of this, the functions performed by all the end fittings are [Cleveland, 2004]:

- To terminate all the layers of the flexible pipe into end connector.
- To transfer all the axial loads and bending moments from the pipe to the connector.
- To provide leak proof and pressure tight interface between flexible pipe and rigid connector.
- To act as a gas relief system which permits the venting of gas entrapped within the pipe annulus due to permeation effect.

Mostly this device is made from AISI 4130 low alloy steel and the terminations can have various design like flanges, hubs etc. [Cleveland, 2004]. It is generally integrated part of the pipe which may either be manufactured during pipe construction or it may be installed at site. Figure 5.18 shows a typical end fitting with flexible pipe terminated in it.

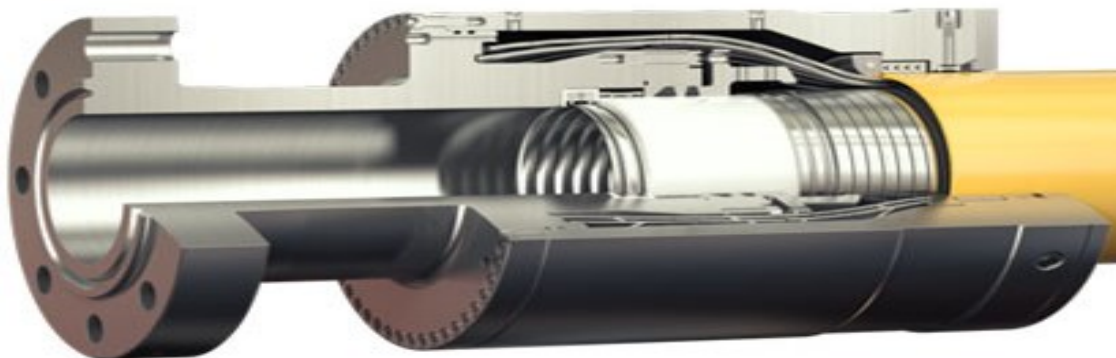

Figure 5.18 - Cross-section of Typical End Fitting [NOV, 2013]

The body of end fitting has following components [Clevelario, 2004]:

- a. **End Body:** It transfers all kinds of loads from the flexible pipe to the connecting flange.
- b. **Outer Casing:** It acts as mechanical protection and also transfer loads between pipe and connector.
- c. **Sealing System:** It consists of two gaskets where first gasket serves as main seal against the fluid and second gasket ensures redundancy. Its main purpose is to provide fluid containment.
- d. **Gas Venting System:** Generally it consists of 3 vent ports distributed evenly around the circumference of end fitting. Its main purpose is to control the pressure inside the annulus by venting the permeated gas.
- e. **Inner Liner and Carcass Holder System:** It is a locking mechanism which terminates the carcass and inner liner in the end fitting. Similar to this system there are other locking mechanisms for termination of other layers of the flexible riser.

Besides these components end fittings have different kinds of coatings like epoxy etc.

5.4.2 Riser Hang-Off Structures

As defined by API RP 17B “it is a structure for supporting a riser at the connection to a platform.” Besides supporting the riser they also facilitate transfer of riser loads during operation to the host platform. Depending on the position of the connection, hang off assemblies can be categorized as external or internal. In external connection the riser is generally hanging from the upper deck level and is imposed to axial, bending and shear loads. While in case of internal connection the riser passes through the I-tube and is connected to its top. For this arrangement the connection is subjected to axial loads only but the MBR of riser at the entry of I tube should be maintained by using bend limiters.

5.4.3 Bend Stiffener

A cone shaped ancillary component that supports the flexible pipe and also increases its bending stiffness in local areas is called bend stiffener. It further prevents over-bending of the pipe in dynamic and static applications and ensures that the pipe does not exceed its designed minimum bending radius (MBR) for the defined tension/angle combinations. The most common area of application of bending stiffener is at the top interface of the flexible riser with stiff end fitting.

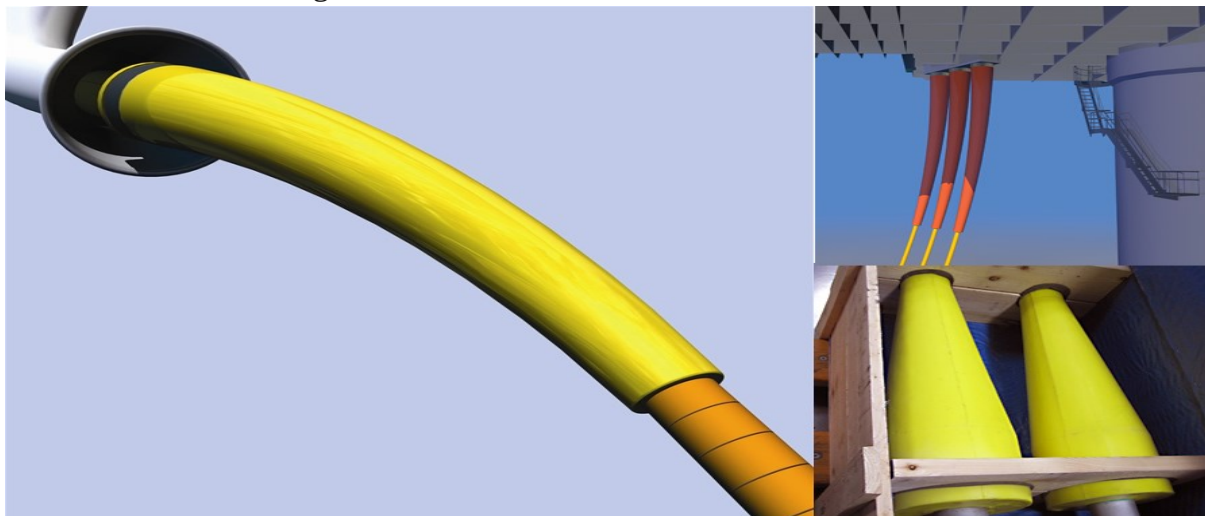

Figure 5.19 – Typical Bend Stiffener [BMP, 2013]

5.4.4 Bend Restrictor

A mechanical device that functions as a mechanical stop to limit the bending curvature of a flexible pipe in static applications [Andersen et al, 2005]. These are used at critical locations along the length of the pipe where the probability of over bending of the pipe is large. Some of common areas of application are top/ bottom connections, J-tube exits and crossings over rigid pipe.

They are made as half rings which are interlocked around the circumference of the pipe at the locations having tendency to exceed MBR. Once locked in its positions it not only prevents further bending of pipe but also takes the excessive bending moment thus preventing damage of the pipe. These may be manufactured from metals, creep resistant material or GRP [API RP 17B, 2008].



Figure 5.20 – Typical Bend Restrictor [BMP, 2013]

5.4.5 Riser Base

A mechanical structure placed on seabed which acts as an interface between flexible riser and flow line. It can either be gravity based, or piled structure or suction/anchor based whose selection depends upon the acting loads and geotechnical conditions [API RP 17B, 2008].

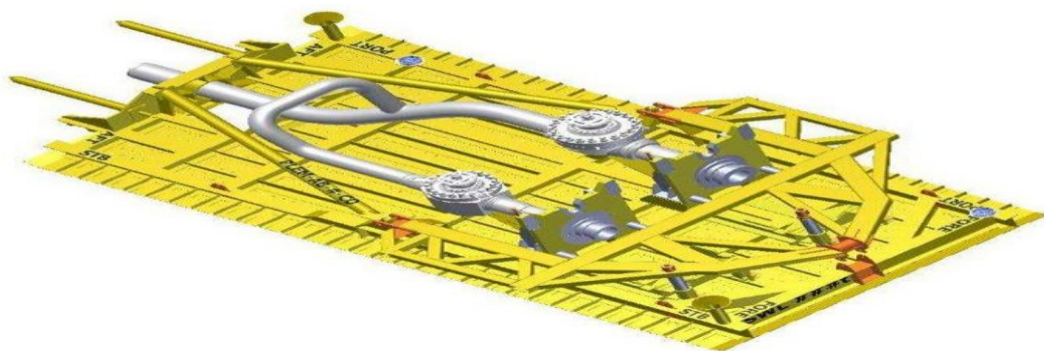

Figure 5.21 – Typical Riser Base Structure [Offshore Energy Today, 2012]

5.4.6 Connector

As stated in API Specification 17J “Connector is a device to provide a leak tight structural connection between the end fitting and adjacent piping.” Connectors may be a bolted flange

or clamped hub. They are present at both the top and bottom interface of the riser and provides fluid containment in their respective connections to the production equipment.

5.4.7 Other Components

It includes buoyancy modules and clamps which are connected to the flexible riser in order to get a desired configuration like Lazy Wave etc. Buoyancy modules provide the net upward force to the riser and they can either be of discrete type (for Lazy Wave) or concentrated type (for Steep Wave).

Clamps are the holding devices which are used to connect ancillary components like buoys etc. to the main pipe.

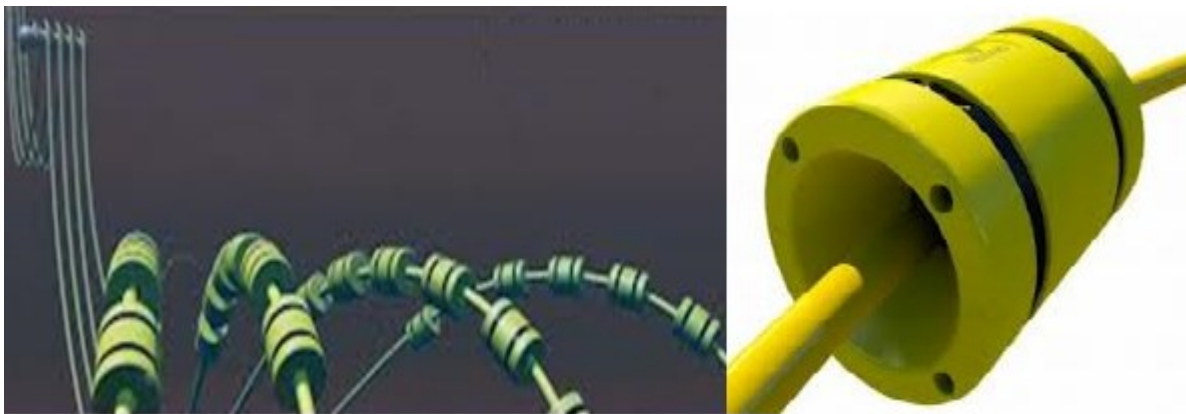

Figure 5.22 – Distributed Buoyancy Modules [Trelleborg Brochure, 2013]

5.5 Design

5.5.1 General

In order to predict the mechanical behavior of the flexible pipes it is essential to formulate the interaction amongst its various constituent layers. This formulation requires detailed design procedure which must follow the relevant design code and should also be certified by 3rd party verification agency like DNV, ABS etc.

Initially, many big oil companies preferred to follow their in-house codes/specifications for designing flexible pipe until the issuance of first reference standard by Veritec in 1987. This document was the result of DNV/Veritec JIP and was the most updated reference document for flexible pipe till then [4 Subsea, 2013]. A year later on 1st June 1988 first edition of API Recommended Practice 17B prepared by George Wolfe came out [4 Subsea, 2013].

In 1993, a JIP was organized which included 21 participants consisting of 12 oil companies and 3 each of manufacturers, regulatory authorities and contractors [Kalman et al, 2013]. The JIP was led by MCS which aimed at updating API RP 17B and developing a new specification for unbonded flexible pipe. The JIP ended in 1996 and issued 1st edition of specification API 17J and in 1998 issued 2nd edition of API RP 17B which for the first time had a dedicated chapter discussing the use of composite materials for making tensile armors [4 Subsea, 2013].

In 2005 second JIP again led by MCS was started with DeepFlex participating in it. The aim of this JIP was to develop new editions of API Spec 17J and API RP 17B which would have sufficient guidelines for the use of composite risers [Kalman et al, 2013]. From January 2010 DeepFlex reviewed API Spec 17J so that it could be used for their patented technology

FFRP®. And as a result of their industrious efforts, in August 2011 it was agreed to add Annexure H dedicated to composite material, in the draft 5th edition of API RP 17B which was finally released in June 2012. The 5th edition of API RP 17B is supposed to be published in 2014 [Kalman et al, 2013].

Today codes, RP and specification which are relevant to flexible pipe system are:

- API RP 2RD - Design of Risers for Floating Production Systems (FPSs) and Tension Leg Platforms (TLPs).
- API RP 17B - Recommended Practice for Flexible Pipe.
- API Spec 17J - Specification for Unbonded Flexible Pipe.
- API Spec 17K - Specification for Bonded Flexible Pipe.
- API Spec 17L - Specification for Flexible Pipe Ancillary Equipment.
- ISO 13628-2, Petroleum and natural gas industries- Design and operation of subsea production systems- Part 2: Unbonded flexible pipe systems for subsea and marine application.
- ISO 13628-10, Petroleum and natural gas industries- Design and operation of subsea production systems- Part 10: Specification for bonded flexible pipe.
- ISO 13628-11, Petroleum and natural gas industries- Design and operation of subsea production systems- Flexible pipe systems for Subsea and Marine applications.
- DNV Rules for Certification of Flexible Risers and Pipes.
- Bureau Veritas NI 364 DTO ROO E -Unbonded Flexible Steel Pipes used as Flowline.

Unbonded metallic flexible pipes follow the guidelines given in the specification API 17J. The design should be such that both the flexible riser and end fittings fulfill the minimum overall functional requirements mentioned under section 4.2 of API 17J. The parameters which are to be designed are [API Spec 17J, 2008]:

- Nominal Internal Diameter.
- Length and tolerances of flexible pipe and end fittings.
- Service life.

However design process is function of riser application based on which it can be divided into two types [API RP 17B, 2008]:

a) Static Application (SA) Design: This design applies to the static riser, flowline and jumper applications. It can be divided into various stages [API RP 17B, 2008]:

- Stage 1-Material selection.
- Stage 2-Cross-section configuration design.
- Stage 3-System configuration design.
- Stage 4-Detail and service life design.
- Stage 5-Installation design.

b) Dynamic Application (DA) Design: This design applies to dynamic riser, loading line and jumper applications. In addition to the five stages mentioned above it has an additional stage in which dynamic analysis and design is done.

Besides the design of the riser, end fitting design is also vital and it should consider all the pipe defects with special focus on pressure, temperature and possibility for pull-out of the internal pressure sheath from the inner seal [API RP 17B, 2008]. Some of the design requirements of unbonded flexible pipe are discussed in separate sections to follow.

5.5.2 Failure Modes of Unbonded Metallic Flexible Riser System

The failure mode of the riser system describes one possible process by which a riser could fail. Table 5.6 lists the possible failure modes which are explicitly considered in unbonded metallic flexible riser structural design calculations [API RP 17B, 2008].

PipeGlobal Failure Mode to Design Against	Potential Failure Mechanisms	SA/DA	Design Solutions/ Variables
Collapse	1. Collapse of carcass and/or pressure armor due to excessive tension.	SA,DA	1. Increase thickness of carcass strip, pressure armor or internal pressure sheath (smooth bore collapse).
	2. Collapse of carcass and/or pressure armor due to excess external pressure.	SA,DA	2. Modify configuration or installation design to reduce loads.
	3. Collapse of carcass and/or pressure armor due to installation loads or ovalisation due to installation loads.	SA,DA	3. Add intermediate leak-proof sheath (smooth bore pipes).
	4. Collapse of internal pressure sheath in smooth bore pipe.	SA,DA	4. Increase the area moment of inertia of carcass or pressure armor.
Burst	1. Rupture of pressure armors because of excess internal pressure.	SA,DA	1. Modify design e.g. change lay angle, wire shape, etc.
	2. Rupture of tensile armors due to excess internal pressure.	SA,DA	2. Increase wire thickness or select higher strength material if feasible. 3. Add additional pressure or tensile armor layers.
Tensile Failure	1. Rupture of tensile armors due to excess tension.	SA,DA	1. Increase wire thickness or select higher strength material if feasible.
	2. Collapse of carcass and/or pressure armors and/or internal pressure sheath due to excess tension.	SA,DA	2. Modify configuration designs to reduce loads.
	3. Snagging by fishing trawl board or anchor, causing overbending or tensile failure.	SA,DA	3. Add two more armor layers. 4. Bury pipe.
Compressive Failure	1. Birdcaging of tensile armor wires.	SA,DA	1. Avoid riser configuration that cause excessive pipe compression.
	2. Compression leading to upheaval buckling and excess bending.	SA,DA	2. Provide additional support/restraint for tensile armors, such as tape and/or additional or thicker outer sheath.

PipeGlobal Failure Mode to Design Against	Potential Failure Mechanisms	SA/DA	Design Solutions/ Variables
Overbending	1. Collapse of carcass and/or pressure armor or internal pressure sheath.	SA,DA	1. Modify configuration design to reduce loads.
	2. Rupture of internal pressure sheath.	SA,DA	
	3. Unlocking of interlocked pressure or tensile armor layer.	SA,DA	
	4. Crack in outer sheath.	SA,DA	
Fatigue Failure	1. Tensile armor wire fatigue.	DA	1. Increase wire thickness or select alternative material, so that fatigue stresses are compatible with service life requirements. 2. Modify design.
	2. Pressure armor wire fatigue.	DA	
Torsional Failure	1. Failure of tensile armor wires.	SA,DA	1. Modify system design to reduce torsional loads. 2. Modify cross-section design to increase torsional capacity.
	2. Collapse of carcass and/or internal pressure sheath.	SA,DA	
	3. Birdcaging of tensile armor wires.	SA,DA	
Erosion	1. Of internal carcass.	SA,DA	1. Material selection. 2. Increase thickness of carcass. 3. Reduce sand content. 4. Increase MBR.
Corrosion	1. Of internal carcass.	SA,DA	1. Material selection. 2. Cathodic protection system design. 3. Increase layer thickness. 4. Add coatings or lubricants.
	2. Of pressure or tensile armor exposed to seawater, if applicable.	SA,DA	
	3. Of pressure or tensile armor exposed to diffused product.	SA,DA	

Table 5.6 - Failure Modes for Primary Structural Design of Unbonded Flexible Pipe [API RP 17B, 2008]

It is important to have knowledge of all these failure modes while designing the riser system. Since all these failure modes are explicitly considered during the design, it is also important to take account of other modes in which the pipe could degrade and eventually fail. These modes may be considered implicitly during the design phase like during material selection or these can be considered at other place like by manufacturer [API RP 17B, 2008].

Table 5.7 lists the failure modes for various types of bend limiters and riser configuration as these are important components/parameters of riser system besides the flexible pipe.

Component	Defect	Consequence	Possible Cause
Bend Restrictors	Unlocking disarrangement	Possible pipe overbending	<ol style="list-style-type: none"> 1. Excessive bending in pipe. 2. Defective or damaged restrictor.
	Position disarrangement	Possible pipe overbending	<ol style="list-style-type: none"> 1. Inadequate clamping of bend restrictor. 2. Impact or abrasion.
	Loss of bend restrictor	Possible pipe overbending	<ol style="list-style-type: none"> 1. Inadequate or damaged clamps. 2. Impact or abrasion.
Bend Limiters (Stiffener and Bellmouth)	Stiffener crack	Possible pipe overbending.	<ol style="list-style-type: none"> 1. Stiffener fatigue. 2. Excessive bending at stiffener. 3. Material degradation.
	Stiffener rupture	Possible pipe overbending or possible tear of outer sheath.	<ol style="list-style-type: none"> 1. Stiffener fatigue. 2. Excessive bending at stiffener. 3. Abrasion or impact damage. 4. Material degradation.
	Stiffener support structure failure	Possible pipe overbending or possible tear of outer sheath.	<ol style="list-style-type: none"> 1. Excessive bending at stiffener and overloading of bindings or support. 2. Impact damage. 3. Structure fatigue of bindings or support structure.
	Bellmouth deformation or inadequate size	Pipe overbending.	<ol style="list-style-type: none"> 1. Bellmouth design or manufacturing fault. 2. Excessive pipe bending around Bellmouth. 3. Impact damage to Bellmouth. 4. "pig tailing" of pipe.
	Stiffener misperformance	Pipe overbending.	<ol style="list-style-type: none"> 1. Inadequate design/design uncertainty (stiffness vs. temperature). 2. Inadequate manufacture (PU curing).
	Flexible Pipe Layout	Pipe Loop	Possible overbending or possible pipe excess torsion.

Pipe Disarrangement	Possible overbending or possible excess torsion or possible ovalisation or possible tear of outer sheath.	<ol style="list-style-type: none"> 1. Anchor dragging. 2. FPS or FPSO excursion outside design limits. 3. Trawl board or other side impact. 4. Point contact.
Riser interference	Possible damage to buoyancy device clamps or bend restrictors or possible overbending or possible impact damage or wear/abrasion of pipe outer sheath.	<ol style="list-style-type: none"> 1. Extreme environmental conditions in excess of design values. 2. Inadequate design to provide required clearance. 3. Loss of buoyancy modules or clamping devices maintaining pipe separation. 4. Anchor dragging. 5. Excessive vessel offset.

Table 5.7 - List of Failure Modes of Components of Riser System [API RP 17B, 2008]

5.5.3 Loads and Load Cases

The flexible pipe should be designed in such a way that it fulfills its functional requirements under all the load classes. Loads imposed on riser system can be classified as [API Spec 17J, 2008]:

- a) Functional Loads:** Loads arising due to physical existence of the riser during operational and installation phases but neglecting the environmental or accidental effects are called as functional loads. Some examples are:
- Loads due to weight and buoyancy of pipe, contents and attachments.
 - Pressure and thermal expansion/contraction loads.
 - External pressure.
 - Testing pressures, including installation and commissioning and maintenance pressures.
 - Loads due to rigid ore flexible pipe crossings/spans.
- b) Environmental loads:** Loads arising directly or indirectly due to environmental parameters like wind, wave and current are called as environmental loads. It also includes loads due to seismic activity and icing wherever applicable.
- c) Accidental Loads:** Loads and motions caused directly or indirectly by accidental occurrences are called as accidental loads. Some examples are loads due to:
- Dropped objects.
 - Trawl board impact.
 - Failure of turret drive system.
 - Anchor line failure.

DNV-OS-F201 uses one extra class of loads called as pressure loads. These are the loads which are strictly due to combined effect of hydrostatic internal and external pressure [DNV-OS-F201, 2010].

The annual probabilities of occurrence for a 20 year service life as recommended by API RP 17B for various load classes is give in Table 5.8.

Type of Load	Service Condition		
	Installation	Service	
Functional	Expected, specified or extreme value.	Normal Service Expected, specified or extreme value.	Abnormal Service Expected, specified or extreme value.
External Environmental	Probability of exceedance according to season and duration of installation period. If abandonment is possible, the maximum weather in a period 3 times the expected installation duration may be used. If abandonment is impossible, a more conservative approach shall be used or the duration of the operation reduced to a period where reliable weather forecast is available (typically hours).	Yearly probability of exceedance > 0.0. If combined with an accidental load the environmental load may be reduced such that the yearly probability of joint occurrence is > 0.01.	Yearly probability of exceedance between 0.01 and 0.0001. If combined with an accidental load the environmental load may be reduced such that the yearly probability of joint occurrence is > 0.0001.
Accidental	As appropriate to installation method.	As appropriate to normal operation conditions i.e. annual probability > 0.01	Individual considerations. Yearly probability between 0.01 and 0.0001.

Table 5.8 - Recommendation on Annual Probability of Occurrence for 20 Year Service Life [API RP 17 B]

A detailed load case matrix is prepared as a part of structural analyses and design process of the riser system. Separate load case matrix is prepared for static and dynamic analysis in which each load case can be further divided in sub load case. Table 5.9 shows an example of load case matrix for FPSO application.

Load Case	Vessel Offset	Condition	Wave and Current Return Period
1	Nominal	Operational Condition - Intact Mooring, Vessel Offset is 10% of Water Depth	100 Year Wave + 10 Year Current
2	Far (+150m)		
3	Near (-150m)		
4	Nominal	Accidental Condition - One Mooring Line Failure, Vessel Offset is 12% of Water Depth	
5	Far (+180m)		
6	Near (-180m)		

Table 5.9 - Example of Load Case Matrix for FPSO Application

5.5.4 Design Criteria

Its purpose is to determine the viability of the project, by defining and applying a design equation that compares a value for the design load (S_d) with the value for the design resistance (R_d). The design is feasible if the equation $S_d \leq R_d$ is satisfied. As mentioned in chapter 3 of thesis that two different approaches namely WSD or LRFD can be adopted as the design criteria. According to specification API 17J which is based on WSD methodology the flexible pipe layers shall be designed to the criteria specified in Table 5.10 [API Specification 17J, 2008].

		Service Conditions			Installation	FAT	
		Normal Operations					
		Recurrent Operation	Extreme Operation	Abnormal Operation			
Flexible Pipe Layer	Design Criteria	Functional Environmental	Functional Environmental & Accidental	Functional Environmental & Accidental	Functional Environmental	Functional Environmental & Accidental	
Internal Pressure Sheath	Creep	The maximum allowable reduction in wall thickness below the minimum design value due to creep in the supporting structural layer shall be 30% under all load combinations.					
Internal Pressure Sheath	Strain	The maximum allowable strain shall be 7.7% for PE and PA, 7.0% for PVDF in static applications and for storage in dynamic applications, and 3.5% for PVDF for operation in dynamic applications. For other polymer materials the allowable strain shall be as specified by the manufacturer, who shall document the material meets the design requirements at that strain.					
Internal Carcass	Stress Buckling Load	$[0.67]$ for $D_{max} \leq 300m$ $\{[(D_{max}-300)/600]*0.18+0.67\}$ for $300m < D_{max} < 900m$ $[0.85]$ for $D_{max} \leq 900m$					
Tensile Armors	Stress	0.67	0.85	0.85	0.67	0.85	0.91
Pressure Armors	Stress	0.55	0.85	0.85	0.67	0.85	0.91
Outer Sheath	Strain	The maximum allowable strain shall be 7.7% for PE and PA. For other polymer materials the allowable strain shall be as specified by the manufacturer, who shall document that the material meets the design requirements at that strain.					

Table 5.10 - Flexible Pipe Layer Design Criteria [API Specification 17J, 2008]

The design criteria specified in API 17J is in terms of the following [API RP 17B, 2008]:

- Strain (polymer sheath).
- Creep (internal pressure sheath).
- Stress (metallic layers and end fitting).
- Hydrostatic Collapse (buckling load).
- Mechanical Collapse (stress induced from armor layers).
- Torsion.
- Crushing Collapse and Ovalisation (during installation).
- Compression (axial and effective).
- Service Life Factors.

The above mentioned factors are discussed in detail under section 5.4.1 of API RP 17B while the detailed design requirements for each layer of unbonded flexible riser can be found under section 5.3.2 of API specification 17J. However permissible levels of degradation of various layers of unbonded flexible pipe required for service life analysis are shown in Table 5.11 [API RP 17B, 2008]

Component	Degradation Mode	Recommendation
Carcass	1. Corrosion	Limited corrosion acceptable provided structural capacity and functional requirements are maintained.
	2. Erosion	Same as for corrosion.
Internal Pressure Sheath	1. Creep	Limited creep acceptable provided: <ul style="list-style-type: none"> • Structural capacity to bridge gaps maintained. • No Cracks. • No locking of carcass or pressure armor layers. • No leakage. • Sealing maintained at end fittings.
	2. Thermal/Chemical Degradation	Capacity at design life to remain within specified usage factors with maximum gaps between layers. No leakage allowed. Increased permeation allowed, if the system has been designed for the increased level of permeation. Important considerations are increased damage rates (corrosion, HIC, SSC) for armors and limits on gas venting system capacity. Strain capacity sufficient to meet the design requirements of table 6 of API Spec 17J.
	3. Cracking	No cracking because of dynamic service.
Pressure and Tensile Armors	1. Corrosion	Only general corrosion accepted. No crack initiation acceptable.
	2. Disorganization or locking of armoring wires.	No disorganization of armoring wires when bending to minimum bend radius.
	3. Fatigue and Wear	Details in Section 8.2.4 of API RP 17B.
Anti-Wear Layer	1. Wear	No wear through the thickness of the layer over its service life.
Intermediate Sheath	1. Thermal degradation	Functional requirements are maintained
Thermal Insulation	1. Thermal degradation	Insulation capacity to be maintained equal to or above minimum specified value.
Outer Sheath	1. General degradation	Strain capacity sufficient to meet the design requirements of table 6 of API Spec 17J.
	2. Radial deformation	No loosening that will cause disorganization of armor wires or strain failure of outer sheath material.

3. Breaching	No breaching allowed unless pipe design under flooded annulus condition can be shown to meet the design requirements and remaining service life requirements.
End Fitting and Carcass/Sheath Interface	1. Corrosion No corrosion acceptable which results in reduction of capacity, possibility for leakage, or damage to any sealing or locking mechanism.

Table 5.11 - Flexible Pipe Layer Design Criteria [API RP 17B, 2008]

5.6 Current Trend & Future

At present there is limited number of companies involved in manufacturing of flexible pipe in the world. While Prysmian manufactures only smaller pipes up to 6" ID, DeepFlex deals with production of composite and hybrid flexible pipes. This leaves the unbonded metallic flexible pipe market being monopolized by three companies namely Technip, Wellstream and NKT Flexibles. Table 5.12 shows a brief comparison between these three companies.

Characteristic	Technip	Wellstream (GE Oil & Gas)	NKT Flexible (NOV)
Year of first flexible pipe manufactured.	1971	1989	1968
Product Offering (ID)	2"-19"	2"-16"	2.5"-16"
Manufacturing Facility Location	Brazil, France, Malaysia & New Upcoming Plant in Brazil	Brazil & UK	Denmark & New Upcoming Plant in Brazil
Market Share Based on Capacity till 2010	52%	36%	12%
Main Geographic Focus	Global	Australia & Brazil	Global
Total Installed Length till 2010 (km)	9500	2500	1500

Table 5.12 – Comparison of Competitors in Unbonded Flexible Pipe Market

Nearly 40 years back Technip (Coflexip then) introduced the technology of unbonded flexible pipe and since then it leads the flexible pipe industry. In the span of 40 years more than 3500 pipes have been installed worldwide and today about 1,200 km of pipe (measured in theoretical length of 8" ID pipe) is installed per year which values to around 1.5 billion US Dollars [Technip Brochure, 2013].

The technology has seen a paradigm shift in terms of operating water depth, ID, maximum operating pressure/temperature and materials. The current status of flexible pipe in terms of these parameters is presented next.

Water Depth (WD): Today about 50% of the installed flexible pipes is in water depth less than 500m, which clearly depicts their widespread use in mid water depth offshore industry due to various technical reasons. The balance 50% has been installed in deep water of which about 7% is in water depth exceeding 1500m [Subsea, 2013].

The companies are trying hard to enable the use of flexible riser in deep and ultra-deep water by making use of new materials like composite. Table 5.13 shows the current status of the unbonded flexible riser in terms of the maximum water depth, while Figure 5.23 depicts their water depth capabilities [Offshore Magazine, November 2010].

Company Name	Status	Specification - Maximum Allowable Water Depth (WD)			
		Water Depth (m)	Associated ID (in)	Max Temperature (degree C)	Integral with Service Lines
DeepFlex	Installed	1500	3	70	N
	Qualified	3500	8	90	N
	Enabling	3500	8	120	N
NKT Flexibles	Installed	1670	6	130	N
	Qualified	2000	6	130	N
	Enabling	4000	8	150	N
Technip	Installed	2100	10	130	Y
	Qualified	3000	9	170	Y
	Enabling	3000	12	170	Y
Wellstream	Installed	2250	6	130	N
	Qualified	4200	2	130	N
	Enabling	3000	9.125	130	N

Table 5.13 – Technology Status of Unbonded Flexible Risers in terms of Max. WD [Offshore Magazine]

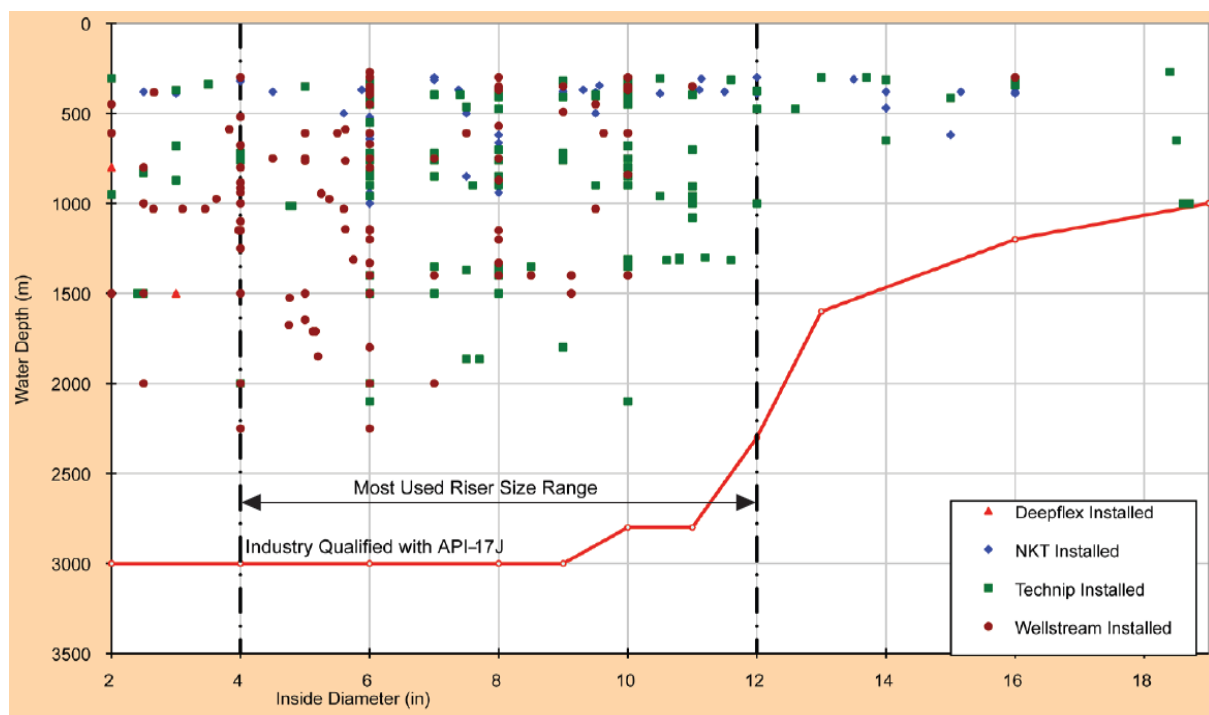

Figure 5.23 – Water Depth Capability of Unbonded Flexible Risers [Offshore Magazine, Nov 2010]

Operating Pressure and Temperature: Since its inception the technology has not changed much in terms of pressure range which varies from 3MPa to 103.4MPa with maximum number of pipes between 20MPa to 35 MPa. The operating temperatures range varies from -10 degree Celsius to 130 degree Celsius with approximately 50% of the pipes operating at or below 60 degree Celsius and nearly 5% operating above 120 degree Celsius [4Subsea, 2013]. Table 5.14 shows the present technology status in terms of maximum allowable pressure while Figure 5.24 depicts their internal pressure capabilities [Offshore Magazine, November 2010].

Company Name	Status	Specification - Maximum Allowable Pressure			
		Pressure (MPa)	Associated ID (in)	Max Temperature (degree C)	Integral with Service Lines
DeepFlex	Installed	42	3	70	N
	Qualified	69	2	70	N
	Enabling	103	2	70	N
NKT Flexibles	Installed	83	9	130	N
	Qualified	83	9	130	N
	Enabling	103	5	150	N
Technip	Installed	138	4	130	Y
	Qualified	138	6	170	Y
	Enabling	128	9	170	Y
Wellstream	Installed	104	4.75	130	N
	Qualified	104	4.75	130	N
	Enabling	104	8	130	N

Table 5.14 – Technology Status of Unbonded Flexible Risers in terms of Max Allowable Pressure

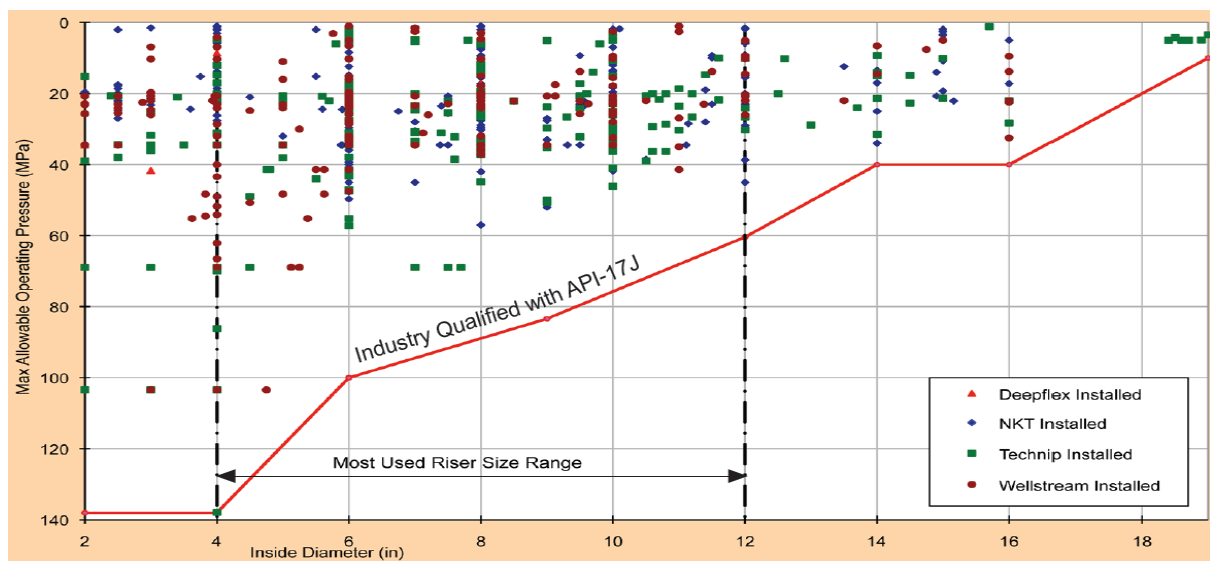

Figure 5.24 – Internal Pressure Capability of Unbonded Flexible Risers [Offshore Magazine, Nov 2010]

Material: The material used to construct various layers of the riser has also seen a considerable change. Initially PA11 was the most common material used for construction of pressure sheath and outer sheath. Though it still remains one of the most used material but now other materials like HDPE, XLPE, PVDF, MDPE and PA-12 are also used widely [4Subsea, 2013].

As many oil and gas fields are turning out to be sour and corrosive so the carcass material has also seen shift from steel grades like AISI 304L to anti-corrosive duplex and super duplex stainless steel. The tensile armors which were initially made from steel are now being replaced by composite material like carbon fiber which makes the riser about 50% lighter [Andersen et al, 2005].

Internal Diameter (ID): Initially 1” pipes were also used but now these are not manufactured any more so the ID now varies from 2” to 18” (ID) with maximum number of the pipes in range 4” to 12”. However there are a few pipes up to 20” for low pressure application [4Subsea, 2013]. Table 5.15 shows the present technology status in terms of maximum inner diameter [Offshore Magazine, November 2010].

Company Name	Status	Specification – Maximum Inside Diameter (ID)			
		Associated ID (in)	Water Depth (m)	Max Temperature (degree C)	Integral with Service Lines
DeepFlex	Installed	8	50	70	N
	Qualified	10	2200	90	N
	Enabling	16	1000	120	N
NKT Flexibles	Installed	16	380	130	N
	Qualified	16	500	130	N
	Enabling	16	1500	150	N
Technip	Installed	19	300	130	Y
	Qualified	19	500	170	Y
	Enabling	21	500	170	Y
Wellstream	Installed	16	250	130	N
	Qualified	16	487	130	N
	Enabling	18	500	130	N

Table 5.15 – Technology Status of Unbonded Flexible Risers in terms of Max. ID [Offshore Magazine]

Flexible Fiber Reinforced Pipe: The future flexible riser technology aims at being used for water depths till 4000m which requires the riser to be lighter and thermally efficient. Both of these advantages can be achieved by use of Flexible Fiber Reinforced Pipe (FFRP®) as discussed in section 4.2.4 of this thesis. But the composite material used to manufacture FFRP is very costly at present and also there is lack of codes dedicated to this product, which has caused a bit of hindrance in its use.

Integrated Production Bundle: Another novel technology which seems to be promising in the deepwater flexible riser industry is Technip’s Integrated Production Bundle (IPB). IPB

consists of the central core around which various elements are assembled depending upon the field requirements. Its main aim is to offer the dual benefits of highly efficient active heating and temperature monitoring system which would prevent formation of hydrates and wax during shut down [Technip Brochure, 2013].

Technip developed this technology for Dalia field situated in offshore Angola which has been producing since December 2006. Eight IPB risers freely hanging from Dalia FPSO at 1360m consists of 12" central bore which is similar to conventional unbonded flexible riser and carries production fluids from seabed to the spread moored FPSO. The outer assembly consists of bundle of tubular elements used for gas lift, electrical cables for active heating system and plastic spacers carrying optical fibers for Distributed Temperature System (DTS) [Technip Brochure, 2013].

The active heating system is used only after the no touch time of 8 hours is surpassed thus mitigating the various flow assurance challenges experienced during the shutdown of the field. The entire structure is encapsulated with an external coating which prevents damage of inner structure from abrasion and seawater ingress [Gloaguen et al, 2007]. Figure 5.25 shows the cross-section of IPB used in Dalia field [Technip Brochure, 2013].

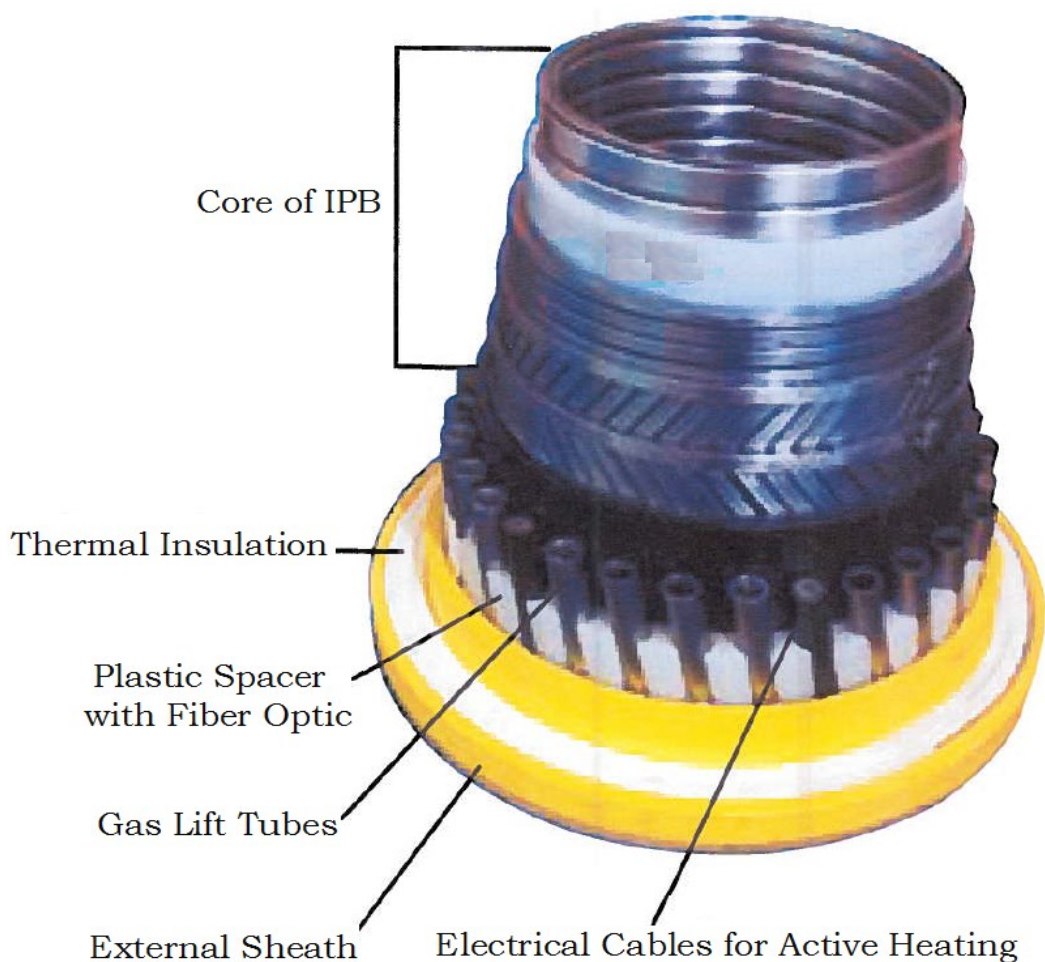

Figure 5.25 – Cross-Section of IPB Riser used in Dalia field [Technip Brochure, 2013]

After the success of Dalia project, two IPB risers have also been installed with FPSO in Pazflor field at 780m water depth in 2010 and later in 2012 six risers were installed with FPSO in Papa Terra field at 1200m water depth in offshore Brazil [Technip Brochure, 2013].

Free Standing Flexible Riser (FSFR): Another future riser technology is Free Standing Flexible Riser which is similar to Free Standing Hybrid Riser (FSHR) except that the vertical section of riser which is a rigid pipe in case of FSHR is replaced by a flexible pipe due to its ease of installation and reduced top assembly requirements. General arrangement of the FSFR system is shown in Figure 5.26.

Both the riser concepts also differ in the shape of buoyancy tank which in case of traditional hybrid risers (FSHR) is a slender structure while in case of FSFR it is a flat buoy having aspect ratio close to 0.5 approximately [Lupi et al, 2014]. The reason for doing so is due to good hydrodynamic features of flat buoy involving lower offsets and minimal Vortex Induced Motions and Rotation compared to traditional FSHR buoy.

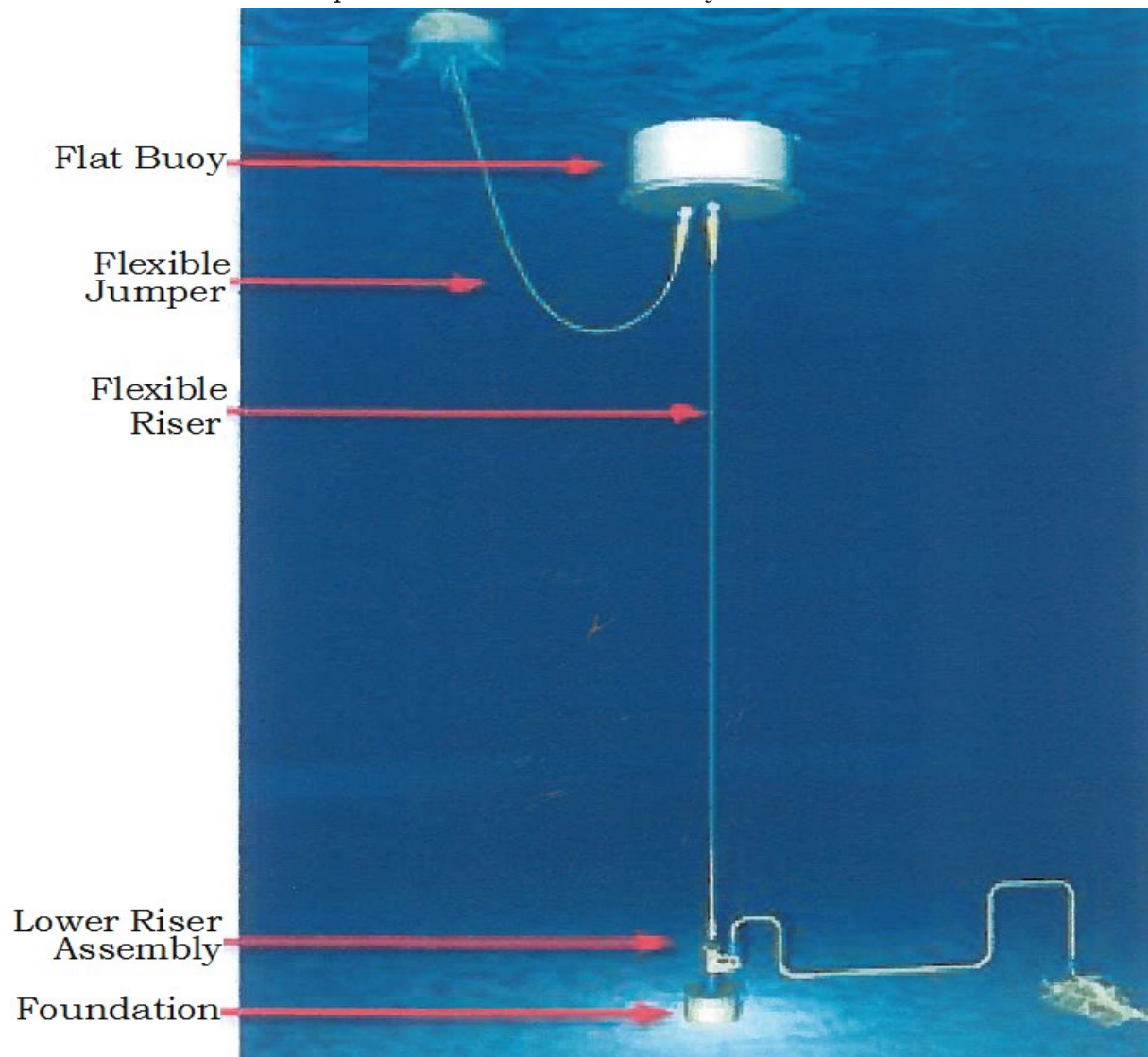

Figure 5.26 – Free Standing Flexible Riser System Overview [Lupi et al, 2014]

In terms of cost difference between FSFR and FSHR, the latter is approximately 30% cheaper for single riser installation however the cost difference is marginal for multiple (up to 5) riser installation [Lupi et al, 2014]. Some of the advantages of FSFR concept are:

- Most of the advantages of hybrid riser discussed in chapter 7, such as low vessel payload, low fatigue damage etc.

- Since flexible riser is under tension so it does not experience compressive loads and large curvatures.
- The FSFR concept doesn't require the need of heavy lifting vessels as the flat buoy is towed to site and ballasted to desired depth. Due to elimination of heavy lift vessel the cost of FSFR is further optimized [Lupi et al, 2014].

Thus FSFR concept which is yet to be field proven and is in development phase seems to be promising option for deep water.

5.7 Advantages and Limitations

5.7.1 Advantages

- 1. Flexibility:** As the name suggests it is an inherent and distinctive property of flexible pipe which allows it to bend to take various complaint configurations depending upon field requirement. High bending ability of flexible riser is provided by helical elements in its unbonded structure. As an example a typical 8" ID flexible pipe can safely have a MBR of 2m [Technip Brochure, 2013]. The complaint configurations can accommodate large vessel offset and makes it a suitable riser option for FPSO/Semi-Sub in deepwater.
- 2. Modularity:** As unbonded flexible pipe wall consists of several independent layers so it is easy to modularize the wall structure depending upon the project requirements. For example the flexible pipes used for water transportation have 4 layers whereas the number of layers in IPB can be up to 20. Such specialized pipe designs serve as panacea for deepwater problems and have been used in deepwater field of WoA (e.g. IPB used in Dalia field).
- 3. Corrosion Resistant:** They have higher anti-corrosive properties than steel pipes. This can be attributed to the use of corrosion resistant steel grades like AISI 304L for carcass construction in case of low corrosive environment. However if the flexible pipe is to be used in highly corrosive environment then duplex or super duplex is used for carcass construction.
- 4. Installability:** Bending ability of pipe allows it to be spooled onto reel/turntable for storage, transportation and installation purpose. Flexibles are produced in long continuous lengths with the ability to make connections on deck thus making the connection process diverless. Consequently laying speed of about 500m/hour can be achieved which is much faster than laying conventional steel pipe [Technip Brochure, 2013]. This is advantageous particularly for locations in remote areas as the cost of mobilizing a typical lay barge would be reduced considerably.
- 5. High Pressure Resistance:** At present the maximum wellhead pressure encountered is about 20000 psi which the current flexible pipe technology can withstand.
- 6. Re-usability:** Flexible pipes are generally designed for 20 years of service life. If their use at one particular field is over and they are still within their service life tenure then they can be recovered and re installed at some other location. This is a common practice in

Brazilian offshore industry as it has dual benefits of improving field economics and conserving environment.

- 7. Less Maintenance:** Flexible pipe are almost maintenance free which means lower inspection regimes and lower Opex.
- 8. Improved Fatigue Life:** When used in compliant configurations like Lazy wave, Steep wave, and Plait wave etc. the fatigue life of the pipe is improved considerably and is much higher than the steel riser.
- 9. Better Thermal Performance:** When compared to steel pipe they have relatively lower Overall Heat Transfer Coefficient (OHTC) hence better thermal performance which can be improved further by increasing the number of insulation layers.
- 10. Installation Weather Window:** Installation weather window is very flexible as for calm weather conditions these can be installed throughout the year while for harsh environments these are generally pre-installed in summers and wet stored on the seabed. On the arrival of the host platform risers are lifted with the help of pullhead and then connected to the vessel.
- 11. Proved Technology:** The technology of unbonded flexible risers is field proven as these have been used from past 40 years. They have extensive track record and today about 80% of the dynamic risers are flexible [Karunakaran, 2013].

5.7.2 Limitations

- 1. Costly:** Fabrication cost of flexible riser is generally two to three times more than steel risers which is a major hassle for their use in deepwaters.
- 2. Collapse Resistance:** The use of flexible riser in deepwater is generally limited due to its low collapse resistance as they tend to collapse caused due to high hydrostatic pressure accompanying large water depths.
- 3. Heavier:** Flexible unbonded metallic risers are generally heavier than steel rigid risers for the same diameter and pressure rating [Palmer and King, 2004]. This means higher vessel payloads and higher tensioner requirements for installation.
- 4. Monopolized Market:** These risers are generally manufactured and installed by the same company and at present there are only 5 companies manufacturing them showing their monopoly which further increases the cost of flexible riser.
- 5. Inspection Techniques:** At present there are limited numbers of inspection techniques which can be employed to inspect flexible riser as the conventional techniques used for steel riser are not very appropriate. Hence there is a technology gap which needs to be reduced by developing flexible riser inspection technology.
- 6. Prone to Hydrogen Induced Cracking (HIC):** When used in sour service conditions, flexible riser allow the permeation of H₂S through its plastic sheath thus exposing steel

armors to the corrosive environment and causing its cracking thereby reducing the performance [Technip Brochure, 2013].

7. Prone to Fatigue: Flexible risers when used in deepwater are subjected to high bending and tension loads at top section near hang off while the bottom section is subjected to high bending and hydrostatic loads. These loads cause fatigue of risers at both hang off location and TDZ.

8. Flow Assurance Challenges: The value of OHTC for conventional flexible risers is generally greater than $3W/m^2K$ which is not suited for deepwater field accompanied with low reservoir temperatures as prevailing in offshore Brazil and WoA. This can be accounted to larger heat loss from increased length of the riser at larger water depths.

9. Complex Design: The design of flexible risers is a hard nut to crack because of the diametrically opposite design objectives of top and bottom section of the riser. While the top section should be designed for high tension loads and low hydrostatic pressure, the bottom section on the contrary must consider high compressive loads and high hydrostatic pressure. The design is further exacerbated with increase in water depth and extreme environments.

10. Material Limitation: The present qualified technology of material used to construct unbonded metallic riser is till 170 deg Celsius, however high temperature wells have temperatures above 200 deg Celsius which renders flexible riser useless for such high temperature wells.

11. Lack of Codes: When it comes to use of composite risers, lack of operational experience and proper international standards forbid their use in deepwater industry.

12. Limited Installation Vessel Availability: If the flexible risers are to be used in water depths exceeding 3000m then the top tensioning requirements during installation from the vertical lay system on the vessel exceeds the present maximum capacity of 550 tons [Technip Brochure, 2013].

5.8 Discussion & Conclusion

The key conclusions that can be made from the chapter are:

1. Bonded metallic flexible pipe is used as jumper while unbonded metallic flexible pipe is mainly used as riser in offshore industry. Unbonded hybrid composite pipe and unbonded nonmetallic pipe seems to be used in future as a riser for deep and ultra-deep water.

2. Some of the most common failure modes of unbonded metallic pipe are: collapse, burst, tensile failure, fatigue failure and birdcaging.

3. At present there are limited number of companies manufacturing flexible pipe which means that the market is monopolized by very few suppliers and hence there is very less competition in bidding process.

4. Qualification programs to enable flexible riser for HP/HT conditions is underway. At present these are qualified for 138MPa and 170 degree Centigrade.

6. RIGID METALLIC RISER

6.1 Definition and History

Rigid metallic risers are lengths of metal pipe (generally steel) extending from seabed to floater unit in various configurations like vertical, catenary and lazy wave. When used with FPSO, vertical rigid risers i.e. TTRs are not feasible due to large stroke motions of the FPSO. Hence only two configurations of steel risers namely Steel Catenary Riser (SCR) and Steel Lazy Wave Riser (SLWR) have been field proven with FPSO in deepwater till now. Therefore hereafter only these two riser configurations will be discussed in this chapter.

First use of SCRs can be dated back to 1994 when these were installed on Shell's Auger TLP in US GoM. Ever since then SCRs have been extensively installed in deepwater industry with wide range of floater units like TLP, spar and semi-sub in Brazil, US GoM and WoA [Bai & Bai, 2005]. The key historical milestones in steel riser technology has been presented in Table 6.1

Riser Type	Area of Application	Year	Reference
Steel Catenary Riser	First SCR installed with Auger TLP at 870m in US GoM	1994	Phifer et al, 1994
Steel Catenary Riser	First SCR installed with semi sub at 605m in Marlim field, offshore Brazil.	1997	Serta et al, 1996
Steel Catenary Riser	First SCR installed with truss spar in Boomvang and Nansen fields at 1120m and 1051m respectively, in US GoM.	2001	Duan et al, 2011
Pipe in Pipe SCR	First Pipe in Pipe SCRs were installed with a semi sub stationed at 1920m in Na Kika field located US GoM	2003	Kopp et al, 2004
Steel Catenary Riser	First SCR installed with FPSO (spread moored) at 1250m in Bonga field, in Angola, WoA.	2004	Bai & Bai, 2005
Steel Lazy Wave Riser	First SLWR was installed with FPSO (turret moored) at 1780m in Parque das Conchas (BC-10) field, offshore Brazil.	2009	Hoffman et al, 2010

Table 6.1 – Historical Milestones of Steel Riser

Till date most of the SCRs have been installed with TLP due to its low drift motions which are generally 9% of water depth [Bai & Bai, 2005]. But for vessels like FPSO stationed in deepwater harsh environment excursions up to 30% of water depth can be encountered. Hence till date there is no steel riser installed with deepwater FPSO in such extreme conditions.

6.2 Configuration

The configurations of steel riser which have been used in deepwater industry with FPSO are: SCR and SLWR. These are explained next.

6.2.1 Steel Catenary Riser (SCR)

When length of steel pipes are connected together they become compliant enough to bend in long radius of curvature and act similar to flexible risers. Such long length of steel riser when connected between FPU and seabed in catenary position is termed as Steel Catenary Riser (SCR). This configuration is compliant enough to absorb the host vessel motions and hence do not require any heave compensator like TTRs.

SCR when hooked to FPSO is suitable for benign environments because in moderate and harsh environments it has significant dynamic response which can cause its fatigue damage at hang off and TDP location. Also at large water depths SCR tend to impose huge vessel payload and its installation also becomes challenging. Therefore to improve its fatigue life and reduce vessel payload lazy wave configuration (SLWR) is used in moderate environments and large water depths.

6.2.2 Steel Lazy Wave Riser (SLWR)

To obtain SLWR configuration, discrete buoyancy modules are attached to the lower section of SCR such that host vessel motion is decoupled from the TDZ of the SCR. SLWR consists of four sections:

1. **Upper Catenary Section:** This section consists of the maximum riser length and forms the top interface with the FPU.
2. **Buoyant Section:** Discrete buoyancy modules are fitted in this portion of riser which creates negative buoyancy to form wave shaped profile. The shape of wave should be a balance between the number of buoyancy modules which represent cost and improved fatigue life.
3. **Lower Catenary Section:** This section lies below the buoyant section and forms the bottom interface with the seabed.
4. **Bottom Section:** This section of riser lies on the seabed and is connected to the flow line.

SLWR is one of the most preferred configurations for deep waters as it allows vessel offsets up to 30%. The primary advantages of SLWR over SCR are reduced vessel payload and improved fatigue life. However installation of SLWR is challenging due to installation of discrete buoyancy modules. Also horizontally extended SLWR called as Long Wave is proposed to be used with deepwater FPSO in harsh weather conditions of North Sea [Karunakaran et al., 1996]

6.2.3 Weight Distributed SCR

Another way to improve the strength and fatigue performance of the conventional SCR for harsh deepwater conditions is to increase weight of the riser along its length and such a variant of SCR is termed as weight distributed SCR. There are two ways in which the weight can be increased along the riser length. These are:

- a. **Varying Density of External Coating:** One way to vary the weight of riser along its length is to simply vary the density of material used for external coating. Thus by using denser material of external coating at the near sag bend region the weight of riser increases

which reduces the TDP movement to large extent and thus improves the fatigue life of the riser.

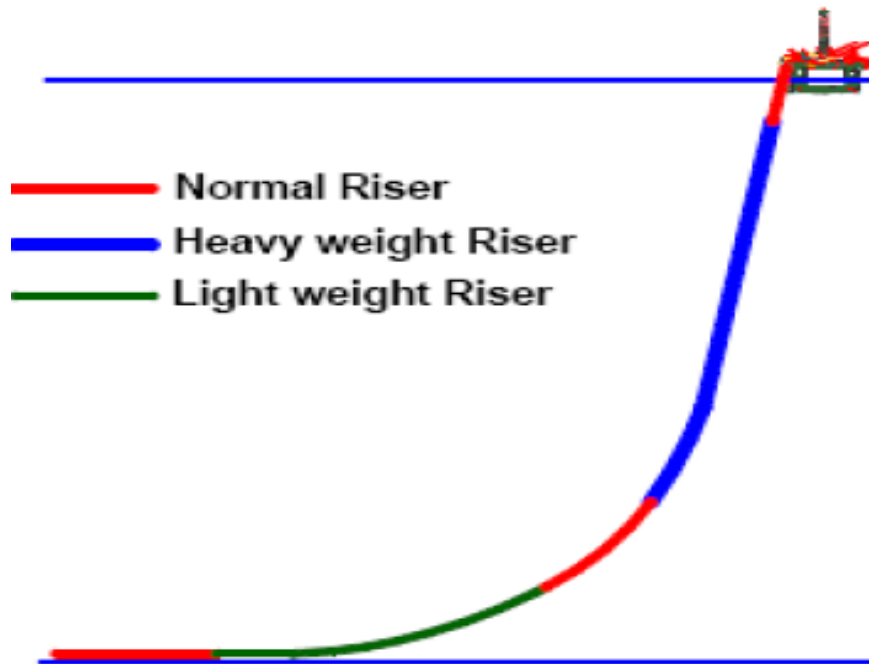

Figure 6.1 – Weight Distributed SCR [Karunakaran et al, 2005]

b. Clump Weight: Alternative to use of different densities of external coating, clump weight can be added to riser length to obtain weight optimized riser. This method was developed for WoA by Foyt et al and it has been successfully installed in Mardi Gas Project in US GoM [Foyt et al, 2007].

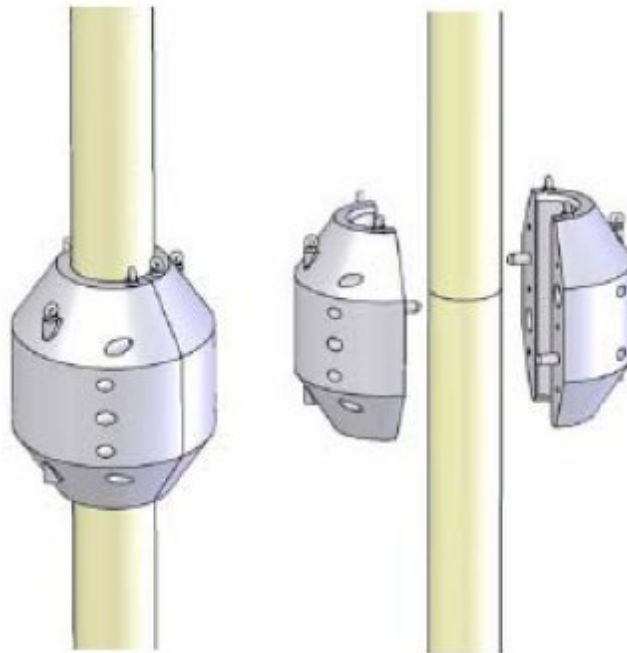

Figure 6.2 – Weight Distributed SCR using Clump Weight [Foyt et al, 2007]

Both of the weight distributed SCRs are particularly suited for deepwater and harsh environmental conditions as the heavy straight segment of the riser above the sag bend

region ensures little movement of the TDP and thus increases the strength and fatigue performance of the SCR.

6.3 Components

The two main components of SCR are riser pipe and flex joint which are described next.

6.3.1 Riser Pipe

The line pipe used for the riser is generally a standard low carbon steel pipe of grade varying from X52 to X70 depending upon the field requirements. However it is a common practice to use mechanically lined pipe/metallurgical clad pipes at the Touch Down Zone and Hang off location to increase the fatigue life of the riser particularly for transportation of corrosive fluid.

Mechanically lined pipes also called as BuBi® is a patented product of German company BUTTING launched in mid 90s. It is produced by hydroforming process where an inner pipe is made up of corrosion resistant alloy and is expanded inside standard Carbon-Manganese (C-Mn) pipe with the help of hydroforming press [BUTTING Catalogue, 2008]. The hydroforming process is shown in Figure 6.3.

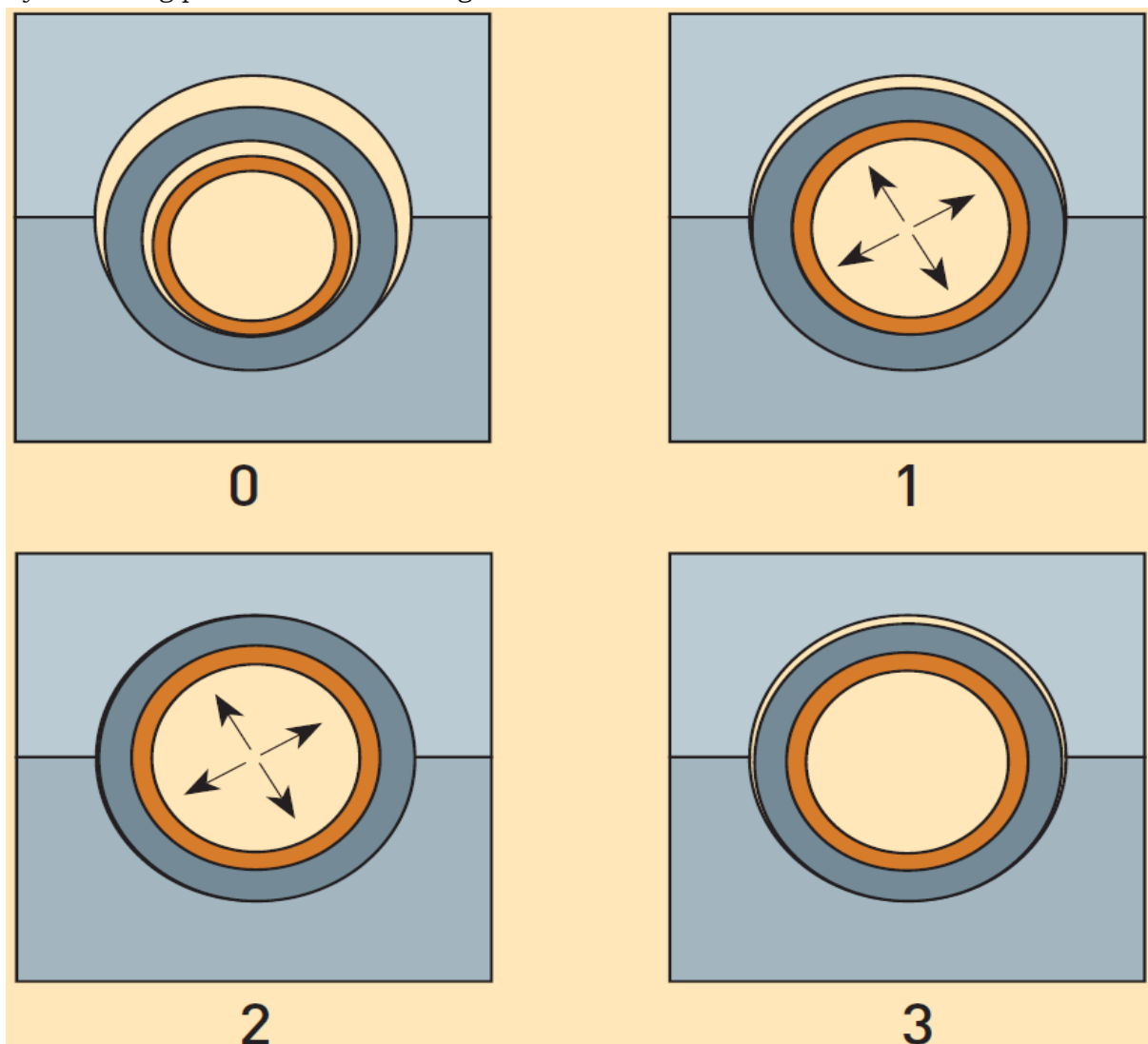

Figure 6.3 – Main Steps of the Hydroforming Process [BUTTING Catalogue, 2008]

The main advantage of hydroforming process is that it allows uniform distribution of pressure which in turn allows uniform expansion of inner pipe inside outer C-Mn pipe and thus preventing its damage. Figure 6.4 shows BuBi® pipe.



Figure 6.4 – Mechanically Lined BuBi® Pipe [BUTTING Catalogue, 2008]

On the contrary in metallurgical clad pipes a thin layer of Alloy 825/625 of thickness up to 3mm is provided inside the standard low carbon steel pipe. The clad layer provides the necessary anti corrosive properties and enhanced fatigue life while the outer pipe provides the required mechanical strength. When compared to metallurgical clad pipe BuBi® pipe offers following advantages [BUTTING Catalogue, 2008]:

1. Because of the manufacturing process and the raw material used is about 25% to 40% cheaper than metallurgical clad pipes.
2. Large variety of products can be made as wide range of pipe materials can be selected for inner and outer pipes.

Some of the projects where metallurgical clad pipe has been used for SCR application are Bonga, Erha, AKPO; however BuBi® pipes have been used for Guara & Lula fields. Both of these pipes have excellent mechanical, fatigue and anti-corrosive properties which makes them an obvious choice for riser application.

6.3.2 Flex joint

The interface of steel risers with FPSO or other FPU is generally done with the help of tapered stress joint (TSJ) or flex joint. “The final selection of TSJ or flex joint depends on hull/ pontoon interface design, technology maturity, and fabrication and installation acceptability criteria” [Ghosh et al, 2012]. The various pros and cons of these two components are shown in Table 6.2.

Hang - off System	Advantages	Disadvantages	Limitations
Flex Joint	<p>Low bending moment on riser top section as it decouples it from FPU's pitch and roll motions.</p> <p>Larger installation tolerances are possible with flex joint.</p>	<p>It is difficult to design & complicated component.</p> <p>It requires lengthy qualification programs for HP/HT application. Also it is expensive when compared to stress joint.</p>	<p>At present only small number of flex joint have been used for HP/HT conditions.</p>
Tapered Stress Joint	<p>Simple to design and construct component as no moving parts are involved.</p>	<p>It cannot be used for riser application where the pitch and roll motions are very high.</p>	<p>It cannot be used for riser application where the pitch and roll motions are very high.</p>

Table 6.2 – Comparison of TSJ vs Flex Joint

However with steel risers coupled to FPSO only flex joint have been used till now hence it will be discussed hereafter.

As defined in DNV-OS-F201 “Flex joint is a laminated metal and elastomer assembly, having a central through passage equal to or greater in diameter than the interfacing pipe or tubing bore, that is positioned in the riser string to reduce the local bending stresses”. Flex Joint connects SCR/SLWR to the FPU such that it absorbs most of the bending moment originating in the top section of the riser due to host vessel motion. It allows the local bending movement of riser thereby mitigating the large bending moments.

One of the most critical components of the flex joint is the flex element which is made up of alternate elastomer layers and steel reinforcements as shown in Figure 6.5.

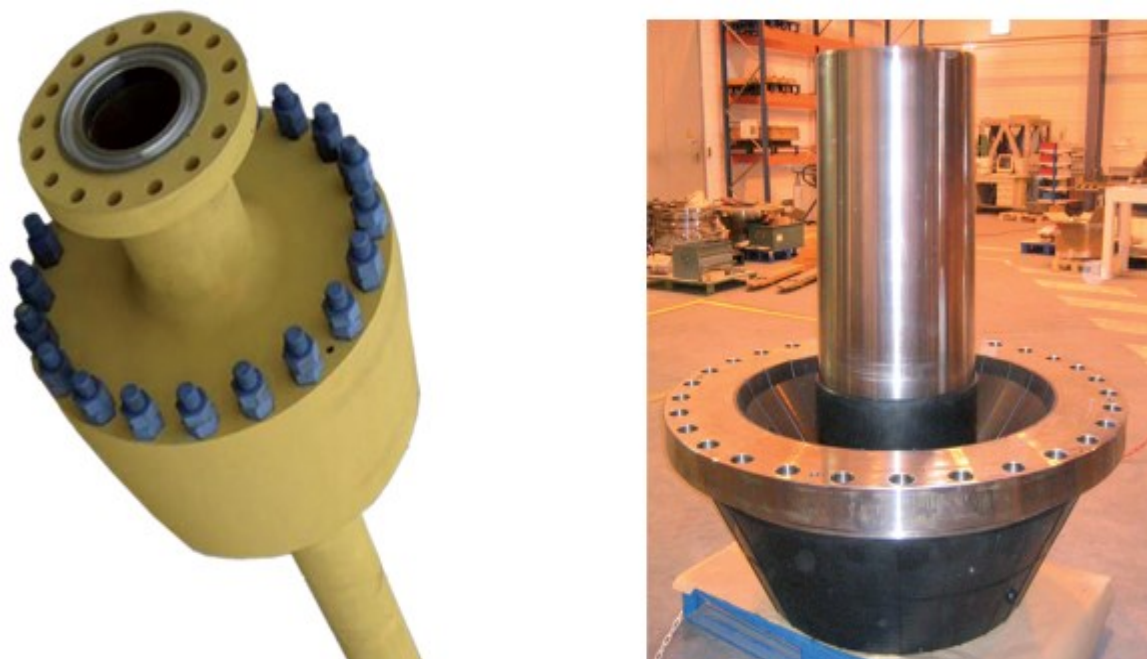

Figure 6.5 – Flex Joint and its Flexible Element [Hutchinson Catalogue, 2010]

At present there are three variants of flex joint, which are shown in Figure 6.6.

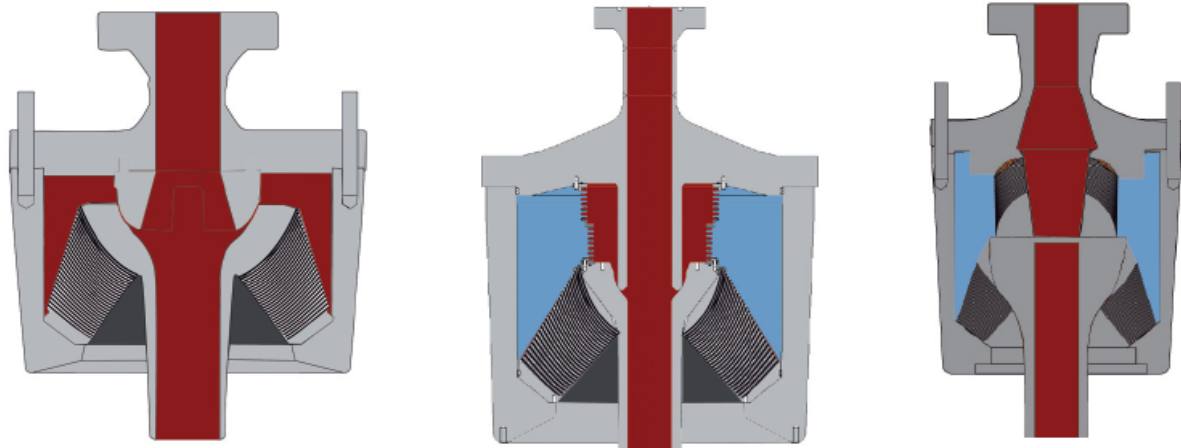

Figure 6.6 – Different Variants of Flex Joint [Hutchinson Catalogue, 2010]

The first one is the standard flexible joint which consists of flex element while the second variant consists of flex element and bellows. The third variant which is the future technology in flex joint industry is termed as fail safe double barrier as it consists of two flexible elements. The upper flexible element serves as a primary high pressure barrier to the fluid while lower flexible element absorbs the loads and acts as second barrier to the fluid thus improving the safety.

Generally flex joint is a tailored product whose design and construction varies depending upon field requirements. For example for AKPO field which was characterized as HP/HT field special qualification programs were done for flex joint which included tests for fluid compatibility, explosive decompression, elastomer ageing and fatigue [Gueveneux, 2010]. Early engagement of vendor and operator is recommended for better design, qualification, testing and timely construction of flex joint.

6.4 Design

As discussed in section 3.2 of this thesis that design of rigid metallic risers may follow recommendations of API RP 2RD employing WSD methodology or of DNV-OS-F201 which adopts the new LRFD format. Both of these are discussed separately next.

6.4.1 WSD Methodology - API-RP-2RD

This code focusses on design criteria dealing with allowable stresses, deflections, hydrostatic collapse, collapse propagation and fatigue each of which is discussed next.

a. Allowable Stress: According to this code the principal stresses should be calculated at important positions along the length of riser. For a plain pipe the three principal stresses are hoop stress, radial stress and axial stress. Thereafter these three principal stresses are used to calculate combined Von Mises equivalent stress given by following equation:

$$\sigma_e = \frac{1}{\sqrt{2}} \sqrt{(\sigma_1 - \sigma_2)^2 + (\sigma_2 - \sigma_3)^2 + (\sigma_3 - \sigma_1)^2}$$

Where:

σ_e = Von Mises Equivalent Stress

$\sigma_1, \sigma_2, \sigma_3$ = Principal Stress

Now API code states that calculated Von Mises stress should be less than allowable stress, which in mathematical terms can be written as:

$$(\sigma_p)_e < C_f * \sigma_a$$

Where:

$(\sigma_p)_e$ = Von Mises Equivalent Stress

σ_a = $C_a * \sigma_y$ = Basic allowable combined stress

C_a = Allowable stress factor = 2/3

σ_y = Material minimum yield strength

C_f = Design case factor = 1 (normal operation)
= 1.2 (extreme operation)
= 1.5 (survival condition)

The usage factor used in WSD mode is based on C_a and C_f and is provided in Table 6.3.

Load Combination	Normal Operation	Extreme Operation	Survival
Functional & Environmental	2/3	4/5	1

Table 6.3 – Usage Factors of WSD format [API-RP-2RD, 1998]

b. Deflections: High deflections must be prevented due to following reasons:

- To avoid clashing between adjacent risers.
- To avoid large bending stresses in the riser.

c. Hydrostatic Collapse: Deepwater risers must be able to withstand high hydrostatic pressure during installation and operation phase. The design criteria as mentioned in API code which must be fulfilled by the deepwater riser is given by:

$$P_a \leq D_f * P_c$$

Where:

P_a = Net allowable external design pressure

P_c = Predicted collapse pressure

D_f = Design factor = 0.75 for seamless or Electric Resistance Welded (ERW) API pipe.
= 0.60 for (DSAW) internally cold expanded API pipe.

d. Collapse Propagation: In case of sudden impact or high bending imposed on riser due to failure of tensioner buckle may be initiated in the riser. This buckle would then travel along the length of riser until the value of external pressure is less than pressure causing buckle to propagate. A common industry practice to avoid buckle propagation is to use buckle arrestors along the length of the riser.

The design criterion which must be fulfilled to prevent buckle propagation is given by:

$$P_d \leq D_p * P_p$$

Where:

P_d = Design pressure differential
 P_p = Predicted propagation pressure
 D_f = Design factor = 0.72

e. Fatigue: Code says that designed fatigue life should be at least 3 times of service life of the riser at places where the safety class is low. However for high safety class locations it should be at least 10 times the service life. Following design criterion should be satisfied:

$$\sum SF_i * D_i < 1$$

Where:

SF_i = Associated safety factor
 D_i = Fatigue damage ratio for each phase of loading

6.4.2 LRFD Methodology – DnV-OS-F201

As discussed under section 3.2 of this thesis that LRFD format considers four limit states namely Ultimate Limit State (ULS), Fatigue Limit State (FLS), Accidental Limit State (ALS) and Serviceability Limit State (SLS). For each limit state different factors for load effect and associated resistances are used.

Load effect factors depends upon the type of design loads which can be divided as functional loads, environmental loads and accidental loads as stated in section 5.5.3 of this thesis. DNV states that load effect factors must be used wherever design load effect is applied. Some of the load effect factors based on limit states & designed loads is shown in Table 6.4.

Limit State	Functional Load	Environmental Load	Accidental Load
	γ_F	γ_E	γ_A
ULS	1.1*	1.3**	NA
FLS	1.0	1.0	NA
ALS & SLS	1.0	1.0	1.0

Table 6.4 – Load Effect Factors [DNV-OS-F201, 2010]

Notes: * If functional load effect reduces the combined load effects, γ_F shall be taken as 1/1.1.

** If the environmental load effect reduces the combined load effects, γ_E shall be taken as 1/1.3.

DNV also states that the factors for associated resistance depend upon the safety class location as stated in Table 6.5.

Safety Class	Definition
Low	Where failure implies low risk of human injury and minor environmental and economic consequence.
Normal	Where failure implies moderate risk of human injury, significant environmental pollution or very high economic/political consequence.
High	Where failure implies high risk of human injury, significant environmental pollution or very high economic/political consequence.

Table 6.5 – Safety Class Classification [DNV-OS-F201, 2010]

The applicable resistance factors are:

- Safety class factor γ_{sc} : its value depends upon the safety class stated in Table 6.5. It accounts for the failure consequence and its values are given in Table 6.6.

Low	Normal	High
1.04	1.14	1.26

Table 6.6 – Safety Class Resistance Factor [DNV-OS-F201, 2010]

- Material resistance factor γ_M : its value depends upon the limit state condition. It accounts for uncertainties in material and resistance and its value are given in Table 6.7.

ULS & ALS	SLS & FLS
1.15	1.0

Table 6.7 – Material Resistance Factor [DNV-OS-F201, 2010]

- Condition factor γ_C : It accounts for special conditions specified explicitly at different limit states where applicable.

The design criteria for each of the limit state shall be discussed next.

a. Ultimate Limit State (ULS): DNV states that limit states which are to be considered for the riser system under this category are:

- **Bursting:** If the pressure of internal fluid exceeds a particular limit then it may cause riser to burst. Hence during operation and testing the riser must fulfill the bursting condition given by:

$$(p_{li} - p_e) \leq p_b(t_1) / (\gamma_M * \gamma_{sc})$$

Where:

$$p_{li} = \text{local incidental pressure} = p_{inc} + \rho_i * g * h$$

With:

$$p_{inc} = \text{incidental pressure}$$

$$\rho_i = \text{density of internal fluid}$$

$$g = \text{acceleration due to gravity}$$

$$h = \text{height difference between actual location and internal pressure reference point}$$

$$p_e = \text{external pressure}$$

$$p_b = \text{burst resistance} = (2/\sqrt{3}) * ((2*t)/(D-t)) * \min(f_y; (f_u/1.15))$$

Where:

$$D = \text{Nominal outside diameter}$$

f_y = yield strength of material

f_u = tensile strength of material

Generally local incidental pressure is taken 10% higher than the design pressure and hence can be written as:

$$p_{li} = p_{ld} + 0.1 * p_d$$

Where:

p_{ld} = local internal design pressure = $p_d + \rho_i * g * h$

p_d = design pressure.

Also the nominal wall thickness of the riser is given as:

$$t_{nom} = t_1 + t_{corr} + t_{fab}$$

Where:

t_{corr} = internal and external corrosion allowance

t_{fab} = absolute value of the negative tolerance taken from the material standard

$t_1 = D / (((4/\sqrt{3}) * (\min(f_y ; (f_u/1.15)))) / (\gamma_M * \gamma_{SC}) * (p_{ii} - p_e) + 1)$

➤ **Hoop Buckling (Collapse):** Besides pressure from inner fluid deepwater riser is also subjected to high external pressure for which it must fulfill following condition:

$$(p_e - p_{min}) \leq p_c(t_1) / (\gamma_M * \gamma_{SC})$$

Where:

p_{min} = minimum internal pressure

$p_c(t)$ = resistance for external pressure (hoop buckling)

$$= p_c(t) - p_{el}(t) * (p^{2c}(t) - p^{2p}(t)) = p_c(t) * p_{el}(t) * p_p(t) * f_0 * D / t$$

Where:

$p_{el}(t)$ = elastic collapse pressure of pipe = $((2 * E * (t/D)^3) / (1 - \nu^2))$

$p_p(t)$ = elastic collapse pressure = $2 * (t/D) * f_y * \alpha_{fab}$

α_{fab} = fabrication factor (can be taken from table 5.7, DNV-OS-F201, 2010)

f_0 = initial ovality = $(D_{max} - D_{min}) / D$

➤ **Propagation Buckling:** Just like WSD format, riser must satisfy a propagation buckling criteria which is given as:

$$(p_e - p_{\min}) \leq p_{\text{ppr}} / (\gamma_M \cdot \gamma_c \cdot \gamma_{\text{SC}})$$

Where:

γ_c = 1.0 if no buckle propagation is allowed
 = 0.9 if buckle is allowed to travel a short distance

P_{ppr} = the resistance against buckling propagation = $35 \cdot f_y \cdot \alpha_{\text{fab}} \cdot (t_2/D)^{2.5}$

Where:

t_2 = $t_{\text{nom}} - t_{\text{corr}}$

➤ **Combined Loading Criteria:** The equation for designing risers subjected to bending moment, effective tension, and net internal overpressure shall satisfy to [DNV, 2010]:

$$(\gamma_M \cdot \gamma_{\text{SC}}) \cdot \left\{ \left(\frac{M_d}{M_k} \right) \cdot \sqrt{1 - \left(\frac{p_{\text{ld}} - p_e}{p_b(t_2)} \right)^2} + \left(\frac{T_{\text{ed}}}{T_k} \right)^2 \right\} + \left(\frac{p_{\text{ld}} - p_e}{p_b(t_2)} \right)^2 \leq 1$$

Where:

M_d = design bending moment
 = $\gamma_F \cdot M_F + \gamma_E \cdot M_E + \gamma_A \cdot M_A$

Where:

M_F, M_E, M_A = Bending moment from functional, environmental and accidental loads.

$\gamma_F, \gamma_E, \gamma_A$ = Load effect factor for functional, environmental and accidental loads.

T_{ed} = design effective tension
 = $\gamma_F \cdot T_{\text{eF}} + \gamma_E \cdot T_{\text{eE}} + \gamma_A \cdot T_{\text{eA}}$

Where:

$T_{\text{eF}}, T_{\text{eE}}, T_{\text{eA}}$ = Effective tension from functional, environmental and accidental loads.

p_{ld} = local internal design pressure

p_e = local external pressure

p_b = burst resistance

M_k = plastic bending moment resistance

$$= f_y \cdot \alpha_c \cdot (D - t_2)^2 \cdot t_2$$

T_k = plastic axial force resistance

$$= f_y \cdot \alpha_c \cdot \Pi \cdot (D - t_2) \cdot t_2$$

Where:

α_c = a parameter accounting for strain hardening and wall thinning

$$= (1-\beta) + \beta * f_u / f_y$$

$$\begin{aligned} \beta &= (0.4 + q_h) && \text{for } D/t_2 < 15 \\ &= (0.4 + q_h) * (60 - D/t_2) / 45 && \text{for } 15 < D/t_2 < 60 \\ &= 0 && \text{for } D/t_2 > 60 \end{aligned}$$

$$\begin{aligned} q_h &= \{(p_{ld} - p_e) / p_b(t_2)\} * (2/\sqrt{3}) && \text{for } p_{ld} > p_e \\ &= 0 && \text{else} \end{aligned}$$

Note: Normally a load is considered simultaneously in global analyses. The effective tension T_e is given as:

$$T_e = T_w - p_i * A_i + p_e * A_e$$

Where:

- T_w = True wall tension
- P_i = Internal (local) pressure
- P_e = External (local) pressure
- A_i = Internal cross-sectional area
- A_e = External cross-sectional area

b. Fatigue Limit State (FLS): According to this limit state structure should have sufficient fatigue life so that it doesn't fail during its service life. Generally there are two methods of fatigue assessment:

- **S-N Curve Method:** The fatigue criterion based on S-N curve as stated in DNV is:

$$D_{fat} * DFF \leq 1.0$$

Where:

- D_{fat} = Accumulated fatigue damage
- DFF = Design Fatigue Factor, as shown in Table 6.8.

Low	Normal	High
3.0	6.0	10.0

Table 6.8 – Design Fatigue Factor [DNV-OS-F201, 2010]

- **Fatigue Crack Propagation:** Fatigue crack growth is designed and inspected to satisfy the following criterion:

$$(N_{tot} / N_{cg}) * DFF \leq 1.0$$

Where:

N_{tot} = total number of applied stress cycles during service or to in service inspection.

N_{cg} = number of stress cycles necessary to increase the defect from the initial to the critical defect size.

DFF = Design Fatigue Factor

c. Accidental Limit State (ALS): As already defined ALS is a limit state due to accidental loads on the riser system. A simplified design check with respect to accidental load is performed in Table 6.9.

Probability of Occurrence	Safety Class Low	Safety Class Normal	Safety Class High
$>10^{-2}$	Accidental loads may be regarded similar to environmental loads and may be evaluated similar to ULS design check.		
10^{-2} to 10^{-3}	To be evaluated on a case by case basis.		
10^{-3} to 10^{-4}	$\gamma_c = 1.0$		
10^{-4} to 10^{-5}	$\gamma_c = 0.9$		
10^{-5} to 10^{-6}	Accidental loads may be disregarded	$\gamma_c = 0.8$	
$<10^{-6}$	Accidental loads may be disregarded		

Table 6.9 – Simplified Design Check for Accidental Loads [DNV-OS-F201, 2010]

d. Serviceability Limit State (SLS): According to DNV, SLS for riser is related to the limitations of deflections, displacements and rotation of ovalization of the riser pipe. As stated by DNV, out of roundness tolerance from fabrication of the pipe shall be limited to 3.0%. This can be written as:

$$f_o = (D_{max} - D_{min})/D \leq 0.03$$

An example of SLS for production risers with surface tree is shown in Table 6.10.

Component	Function	Reason for SLS	Comment
Riser Installation	Running and retrieving the riser	A weather limitation would be set to avoid riser interference.	Usually run on guide wires in close proximity to other risers.
Riser Stroke	Limit the frequency of bottom out.	The tensioner may be designed for bottom out.	Energy absorption criteria shall be specified.
	Limit the design requirements for the jumper from the surface tree to the topside piping.	The tensioner may be designed for bottom out.	Energy absorption criteria shall be specified.

Table 6.10 – Example of SLS for Production Risers with Surface Tree [DNV-OS-F201, 2010]

6.5 Current Trend & Future

Till date all the SCRs tied back to FPSO have been installed in benign environments of Nigeria. However there is only one SLWR tied back to FPSO and it is installed in offshore Brazil having moderate environment.

Figure 6.7 shows the water depth capabilities of SCRs and SLWR which have been installed with deepwater FPSO worldwide.

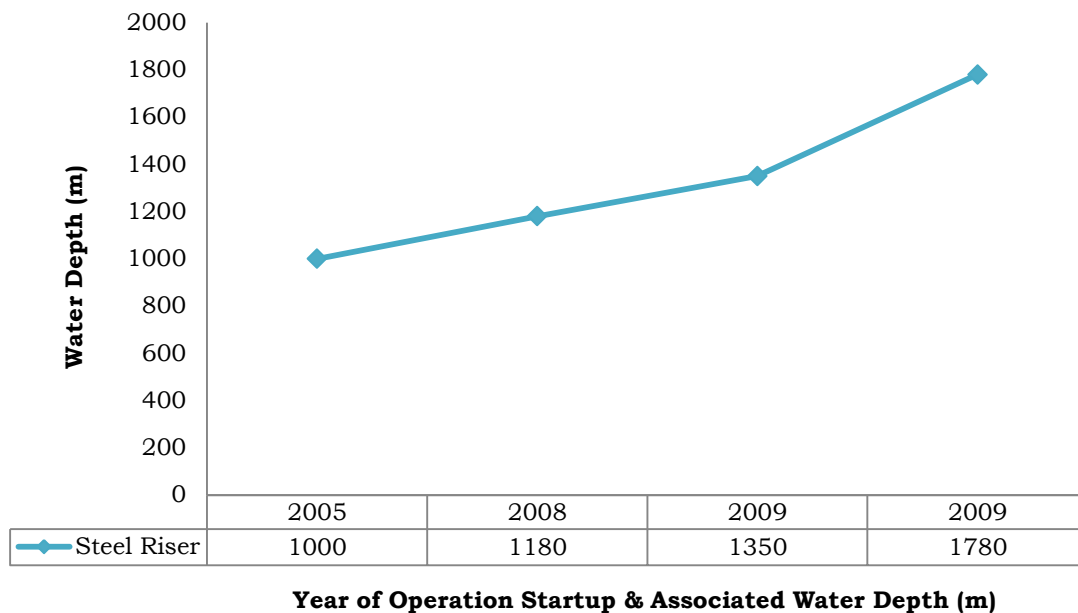

Figure 6.7 – Water Depth Capabilities of Steel Risers with Years of Starting Operation

Note: Figure 6.7 does not show SLWR which Shell is planning to install with disconnectible turret moored FPSO (2900m) for their Stones field in US GoM. Also in figure 6.7 the first three data is for SCRs while the last data is for SLWR.

From Figure 6.7 it can be clearly said that steel risers have been used for water depths greater than 1000m and with the passage of time their water depth capability has increased.

At present a research program by RPSEA is being carried on in which ultra-deep riser concepts hooked to high motion vessels like semi-sub and FPSO are being studied. The riser concepts which are being considered in the study are [Royer et al, 2013]:

- Steel Catenary Riser (SCR)
- Steel Lazy Wave Riser (SLWR)
- Steep Wave Riser (SWR)
- Complaint Vertical Access Riser (CVAR)
- Buoyancy Supported Riser (BSR)
- Hybrid Riser Tower (HRT)

SCR and SLWR have been discussed in section 6.2 while BSR and HRT will be discussed in section 7.2 of this thesis. Hence SWR and CVAR will be discussed as these can be future steel riser configurations to be used in deep and ultra-deep water.

Steep Wave Riser (SWR): As defined in API RP 17B “Lazy wave with a touchdown point fixed to the seabed”. Thus this configuration differs from SLWR in the sense that in case of SWR riser terminates in riser base in near vertical position while in case of SLWR it terminates horizontally. One of the biggest advantages of SWR over SLWR is that it is less prone to change in bore content density and requires less sea floor area due to its vertical termination in the riser base. Owing to these advantages it can replace SLWR in the near future however it is still being studied.

Compliant Vertical Access Riser (CVAR): It is a differentiated riser configuration which is obtained by use of buoyancy modules attached to lower section of riser and additional heavy weights attached to its upper section as shown in Figure 6.8 [Martins et al, 2012].

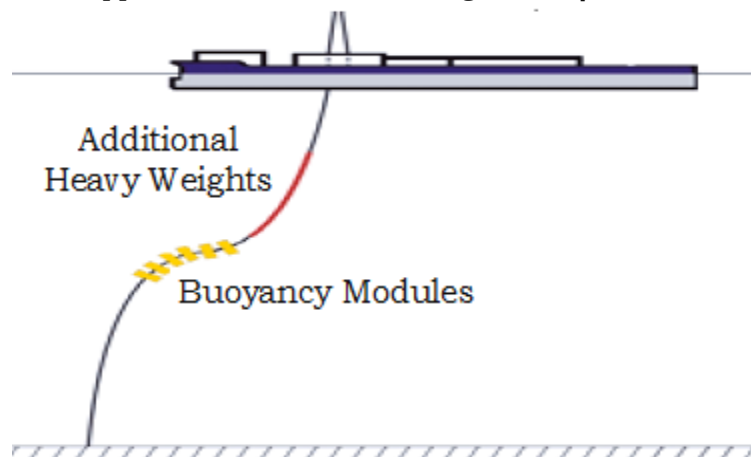

Figure 6.8 – Compliant Vertical Access Riser Concept [Martins et al, 2012]

A horizontal offset is provided between top and bottom section of the CVAR configuration by means of extra riser length which is called as riser overlength. Mathematically it is depicted by overlength fraction which is ratio of the overlength to horizontal distance between top and bottom riser connection points [Martins et al, 2012]. Overlength fraction is a very important parameter as it defines the extent of compliance of CVAR. Hence larger this fraction is, more compliant the riser configuration is thus keeping extreme stresses within specified range [Martins et al, 2012].

The patent of CVAR was first filed in year 1988 and since then lot of studies has been carried out in this direction. For example a study in which CVAR was hooked up to FPSO was done by Ishida et al and was presented in Offshore Technology Conference (OTC) in year 2001. At present CVAR is still under study and some of the advantages which can be listed based on the study carried till now are [Martins et al, 2012]:

- CVAR allows direct well intervention form production vessel thus eliminating the need of costly well intervention vessels.
- In ultra-deep water CVAR can easily replace conventional SCR and SLWR as it is more compliant configuration, thus reducing the vessel payload and improving the fatigue life.
- CVAR allows the use of dry trees even with FPSO.

Though CVAR offers several above mentioned advantages it is difficult to design configuration and needs more study and research to make its practical use in ultra-deepwater.

Besides studying various configurations for ultra-deep water risers in RPSEA project, studies into material of construction for riser materials is also being done. Wide range of materials which are being studied includes [Royer et al, 2013]:

- Carbon Steel Line Pipe (API 5L X70), welded
- Carbon Steel Line Pipe (API 5L X70) with CRA-clad ID, welded
- High strength Steel OCTG (5CT Q 125) with CRA-clad ID, threaded and coupled
- Super Duplex Stainless Steel Pipe, welded
- Titanium Pipe, welded
- Carbon Fiber Composite – Reinforced Carbon Steel Pipe, welded or mechanically connected.

However to save time a particular combination of material/configuration is being studied in the project which is shown in Table 6.11.

Configuration	Pipe Material				
	Carbon Steel	Super Duplex	Titanium	High Strength Steel	Composite Reinforced Pipe
SCR	Yes	Yes	Yes	Yes	Yes
SLWR	Yes	Yes	No	Yes	Yes
SWR	Yes	Yes	No	Yes	Yes
CVAR	Yes	Yes	No	Yes	No
Jumper for BSR or HRT	Yes	Yes	Yes	No	No

Table 6.11 – Material/Configuration Combination Being Studied in RPSEA Project [Royer et al, 2013]

The study is expected to be completed in August 2015 and results will be interesting to see. Maybe a new riser system will be developed which can be coupled to FPSO stationed in ultra-deepwater.

Titanium Riser: In the near future steel risers can be replaced by Titanium risers because of Titanium’s high strength, low weight, high flexibility, high fatigue resistance, and more chemical resistance [Karunakaran et al, 2004]. This makes it an obvious choice for catenary risers, except that it is highly expensive which has restrained its use till now as riser concept. Hence, “Titanium Catenary Risers” (TCR) is a viable option for:

- Shallow water applications where chances of fatigue failure are more than deep water.
- Highly sour service conditions where steel risers cannot be used.

Till now there are no TCR installed, but these have been developed to a stage where they can be used for the gas export risers for the Åsgard B and Kristin platform [Karunakaran et al, 2004].

6.6 Advantages & Limitations

6.6.1 Advantages

1. Less Costly: When compared to flexible risers, steel risers are approximately 50% cheaper, which is a major advantage in favor of steel risers.

- 2. Light Weight:** In comparison to flexible risers, steel risers are lighter and hence they impose less vessel payloads. Due to this advantage steel risers are replacing flexible riser for deepwater applications in benign environments.
- 3. High Collapse Resistance:** Steel risers have larger collapse resistance when compared to flexible risers which permits its use in deepwater even with large diameters.
- 4. Simple Design:** SCR in particular is a very simple to design riser system as it does not require any complicated end fittings and bottom assemblies.
- 5. No Heave Compensator:** When compared to Top Tensioned Risers (TTRs), steel risers do not require any heave compensator as they are compliant enough to accommodate vessel motions.
- 6. Non - Monopolized Market:** Unlike flexible risers which can be manufactured by very few manufacturers, steel risers can be fabricated and installed by large number of companies, this eases the bidding process.
- 7. Suitable for Sour Service Conditions:** Steel risers having internal clad layer are suitable for sour service conditions and hence can replace flexible risers in such conditions.
- 8. Easy Installation:** SCRs particularly can be installed by large number of methods such as J-lay, S-lay and reel lay which are industry proven. Also large number of contractors can install SCRs.
- 9. Wide Application Range:** Steel risers are suitable for large range of diameters varying from 6" to 30" in water depths varying from 600m to 2000m.
- 10. Assists the Mooring System:** Steel risers being compliant in nature has a tendency to assist the mooring system in keeping the floater unit stationed at a particular position.
- 11. Suitable for HP/HT Conditions:** Steel risers can be used as an alternative to flexible risers for HP/HT conditions as flexible riser technology is still not qualified for these conditions.
- 12. Large Local Content:** Construction of steel riser unlike flexible riser is generally carried out in local yard which involves large number of local workforce. Thus providing employment opportunities to the local workforce.

6.6.2 Limitations

- 1. High Dynamic Response:** Steel risers especially SCRs have high dynamic response especially when they are tied back to FPSO/semi-sub in harsh environments.
- 2. Poor Fatigue Performance:** As a result of high dynamic response the fatigue life of SCR at hang off and TDP is reduced considerably which results in poor fatigue performance.
- 3. Large Subsea Footprint Area:** Particularly for SCR and SLWR the riser spread is very large which means that these riser concepts cannot be used in congested seabed conditions. SCRs require a radial spread of 1 to 1.5 times of the water depth they are

installed at [Howells and Hatton, 1997]. So with the increase in water depth the corresponding SCR spread increases which can become a hassle for congested fields.

4. Clashing Issues: In case of large number of steel risers attached to host vessel, clashing may occur between adjacent risers and mooring lines. This can lead to serious accident and hence must be prevented.

5. Risk of Compression at TDP: In case of light weighted SCRs which are attached to FPSO in harsh environment conditions which can have heave stroke up to 10m, the chances of compression of SCR at TDP is huge.

6. Limited Thermal Performance: Steel risers cannot have OHTC of less than 3 W/m²K. This is because as the thickness of wet insulation on the riser increases, it tends to become lighter and hence is subjected to more severe dynamic motions thereby causing its fatigue.

7. Tighter Tolerances during Fabrication: SCRs which are tied back to FPSO has to be fabricated to tighter tolerances in order to avoid fatigue issues. This is a daunting task and it increases the fabrication cost on per weld basis [Subsea7, 2013].

8. Requirement of High Specification Welds: SCR and SLWR require high specification girth welds for better fatigue performance. Also stringent acceptance criteria is used which again require high quality welds.

9. Susceptible to VIV Fatigue Damage: For regions like US GoM where high current velocities are dominant VIV may result in severe fatigue damage of steel risers.

6.7 Discussion & Conclusion

The key conclusions that can be made from the chapter are:

1. Steel risers are preferred over flexible riser for deep water because of their cost effectiveness, less weight and high collapse resistance even at large diameters. The two configurations in which steel risers are used is SCR and SLWR.

2. At present there are three SCRs and one SLWR installed with deepwater FPSO worldwide. All three SCRs have been installed with spread moored FPSO in Nigeria while one SLWR is installed with internal turret moored FPSO in offshore Brazil.

3. The key design issues with SCRs are low fatigue life of hang off and TDP, large subsea footprint area and clashing.

4. It is a common industry practice to use metallurgical clad/mechanically lined pipe near hang-off location and TDZ of SCR in order to improve its fatigue life.

5. A research program by RPSEA is being carried out presently where they are assessing different rigid riser concepts and materials of riser for ultra-deepwater application. The results will be published in August 2015 and will be interesting to see.

7 HYBRID RISER

7.1 Definition and History

Hybrid riser can be defined as an assembly of upper flexible section and lower rigid section having an interface at subsurface buoy. The flexible riser section is connected to the host vessel while the lower rigid riser section is connected to a foundation pile on the seabed.

Depending upon the shape of the lower rigid portion of the hybrid riser they can be classified as Free Standing Hybrid Riser (FSHR) and Buoyancy Supported Riser (BSR). While in FSHR the rigid riser is a vertical section, the same in case of BSR is having a catenary shape. Both also differ in the shape of subsurface buoy, with FSHR having a cylindrical buoyancy tank/can while BSR having H-shaped buoy. However for both riser concepts the buoy is generally placed 50 to 250m below the sea level where the wave, wind and current effects are minimal.

The evolution of the hybrid risers can be divided into four phases with the first patent being filed in the year 1978. At that time research efforts were initiated by Mobil Corporation to evolve the early design of hybrid risers, with Institut Français du Pétrole (IFP), France joining the research later in mid 1980s [Marcoux and Legras, 2011].

The key historical milestones in hybrid riser technology are presented in Table 7.1.

Hybrid Riser Type	Area of Application	Year	Reference
1 st Generation Hybrid Bundle Riser	First hybrid riser installation was in Grand Canyon Block 29 in US GoM. It was tied back to Semi - Sub stationed at 466m water depth.	1988	Fisher & Berner, 1988
2 nd Generation Hybrid Bundle Riser called as Hybrid Riser Tower (HRT)	First HRT installation was in Girassol field, offshore Angola. It was also first hybrid riser to be tied back to FPSO. All the riser lines (production, water injection etc.) were encapsulated in single foam module which provided thermal insulation and buoyancy.	2001	Bai & Bai, 2005
3 rd Generation Hybrid Riser called as Single Hybrid Riser (SHR)	First SHR installation was in Block 15, offshore Angola. It was tied back to spread moored FPSO Kizomba A stationed at 1180m water depth.	2004	Bai & Bai, 2005
3 rd Generation Hybrid Bundle Riser	For HRT installed in Greater Plutonio field, thermal insulation and buoyancy functions were dissociated. Hence riser lines were individually coated with wet thermal insulation and were placed outside the foam block whose purpose was to provide buoyancy only.	2007	Tellier & Thethi, 2009
Buoyancy Supported Riser (BSR)	First BSR installation was in Guaro Sapinhua and Lula NE pre salt fields, offshore Brazil. It was tied back to spread moored FPSO stationed at 2100m water depth.	2012	Subsea 7, 2013

Table 7.1 – Historical Milestones of Hybrid Riser

As discussed in chapter 4 of this thesis that till date most of the hybrid risers have been installed in deepwater fields of WoA having benign environment. The only exception to this are SHRs located in Cascade and Chinook field in US GoM and BSRs located in 2 pre salt fields located in Santos Basin of Brazil.

7.2 Configuration

Over the past 25 years hybrid risers have seen a significant change in their construction and configuration. This variation can be segmented into four main phases, each of which is explained next.

7.2.1 1st Generation Hybrid Riser

Some of the main features of this class of hybrid riser are:

1. Bundled arrangement.
2. Due to large size and heavy weight these were installed through moonpool of semi-sub drilling rigs.
3. Riser tower is placed in between the port and starboard pontoons of the semi sub floater unit.
4. All the production and service lines are encapsulated in single foam module which provided dual functions of thermal insulation and buoyancy.
5. Rigid solution consisting of modified collet connector and titanium stress joint was used to connect Lower Riser Assembly (LRA) and foundation to reduce bending loads on riser segment [Tellier & Thethi, 2009].

This class of hybrid risers was first installed in year 1988 in Grand Canyon Block 29. It was later on removed, refurbished, upgraded and re installed in Grand Banks Block 388 with semi-sub in year 1994 as shown in Figure 7.1 [Tellier & Thethi, 2009].

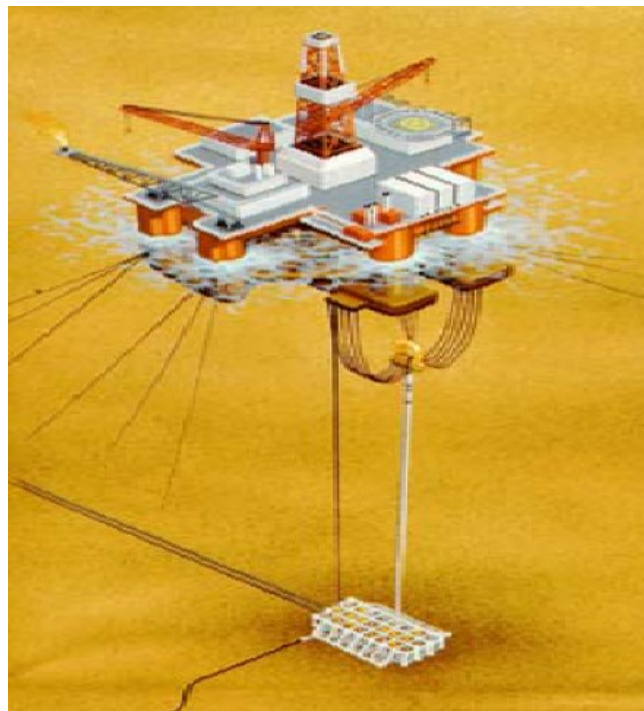

Figure 7.1 – Bundled Hybrid Riser in Grand Banks Block 388 [Tellier & Thethi, 2009]

As can be seen from Figure 7.1 that in 1st generation of hybrid risers were non offset from the host vessel as the riser bundle was placed in between the port and starboard pontoon of the semi sub. The flexible risers were tied back to the semi-sub such that they were free to move vertically to absorb the floater motions. The number of flexible risers was kept equal on both the pontoons to maintain stability of the floater unit [Tellier & Thethi, 2009].

Due to large overall OD of the riser tower and heavy weight the installation had to be done through moonpool of semi-sub drilling rig which proved very expensive. Hence high costs and complex design kindled an urge in the mind of engineers to improve this riser concept which resulted into 2nd generation of hybrid risers explained next.

7.2.2 2nd Generation Hybrid Riser

Some of the main features of this class of hybrid riser are:

1. Bundled arrangement.
2. Towed to site and upended, hence provides cost savings over 1st generation of hybrid risers.
3. Riser tower is laterally offset from the floater unit.
4. All the production and service lines are encapsulated in single foam module which provided thermal insulation and buoyancy.
5. The connection between LRA and suction pile foundation is made with Roto-latch flexible joint [Tellier & Thethi, 2009].

This class of hybrid risers was first installed in year 2001 in Girassol and then in 2007 in Rosa field. Figure 7.2 shows the HRTs installed in Girassol field with spread moored FPSO.

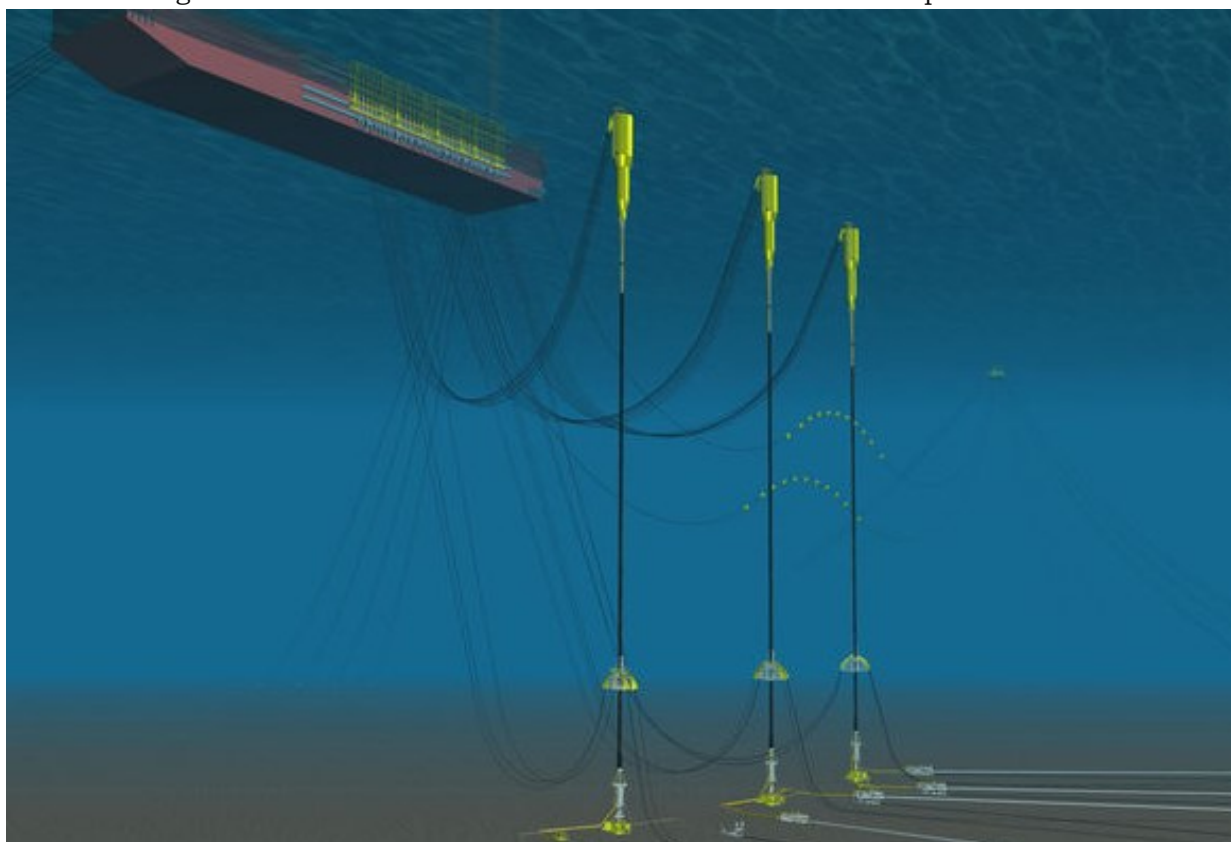

Figure 7.2 – Girassol HRT field arrangement [Subsea 7, 2013]

The cross-section of HRTs and its foam module installed in Girassol is shown in Figure 7.3.

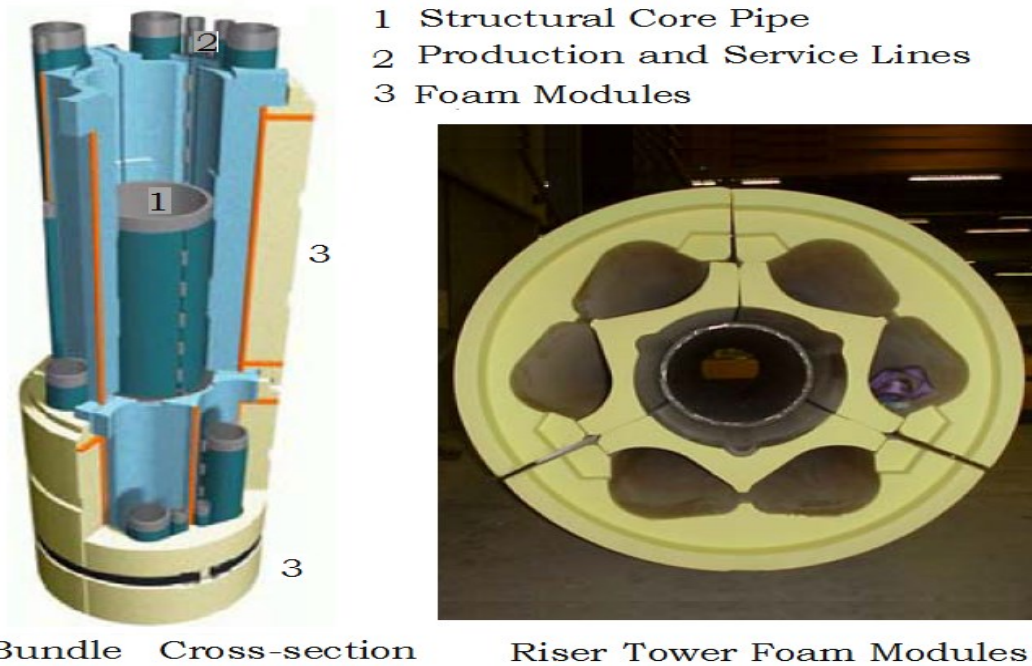

Figure 7.3 – Cross section of 2nd Generation HRT and Foam Modules [Rouillon, 2002]

7.2.3 3rd Generation Hybrid Riser

This generation of hybrid risers has two categories. The first category is an upgraded version of 2nd generation HRT while another class consists of Single Hybrid Risers. These are explained separately next.

3rd generation HRT: It was first installed in Greater Plutonio field in 2007 and it shared almost same features of the 2nd generation HRT listed in section 7.2.2. However in it the insulation and buoyancy functions were separated unlike 2nd generation HRTs in which foam modules served dual purpose of thermal insulation and buoyancy.

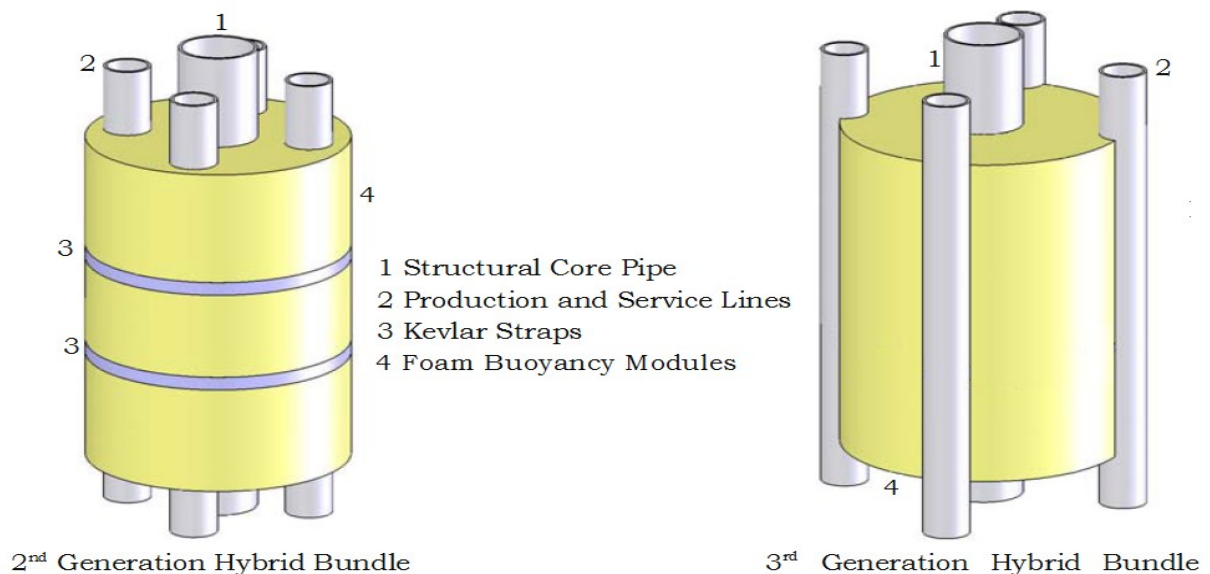

Figure 7.4 – 2nd and 3rd Generation HRT [Tellier & Thethi, 2009]

From Figure 7.4 it can be said that in 3rd generation HRT production and service lines are placed on outer periphery of the foam buoyancy modules which allows their visual inspection unlike 2nd generation HRTs. The foam module had a function of providing only the buoyancy and consisted of two shells which were bolted together unlike 2nd generation design employing pre tensioned Kevlar straps to hold the foam modules.

The key advancements of Greater Plutonio design over Girassol design are [Tellier & Thethi, 2009]:

- No seawater ingress inside the bundle hence no convection design issues.
- Easy to fabricate and assemble.
- Insulation and buoyancy functions are separated, as foam modules provide only with the necessary buoyancy and hence has simpler geometry.
- Production and service lines were individually coated with wet thermal insulation so lower value of OHTC was achieved.
- Visual inspection of production and service lines can be done as they are placed outside the foam modules.

3rd Generation Single Hybrid Riser (SHR): An alternate hybrid riser arrangement is Single Hybrid Riser (SHR) which unlike bundle HRT utilizes a single steel riser to transport well fluids from the seabed to the FPU thereby mitigating the risk of failure of entire riser in case structural core fails.

Figure 7.5 shows SHR installed with external turret FPSO (PSVM) stationed in offshore Angola.

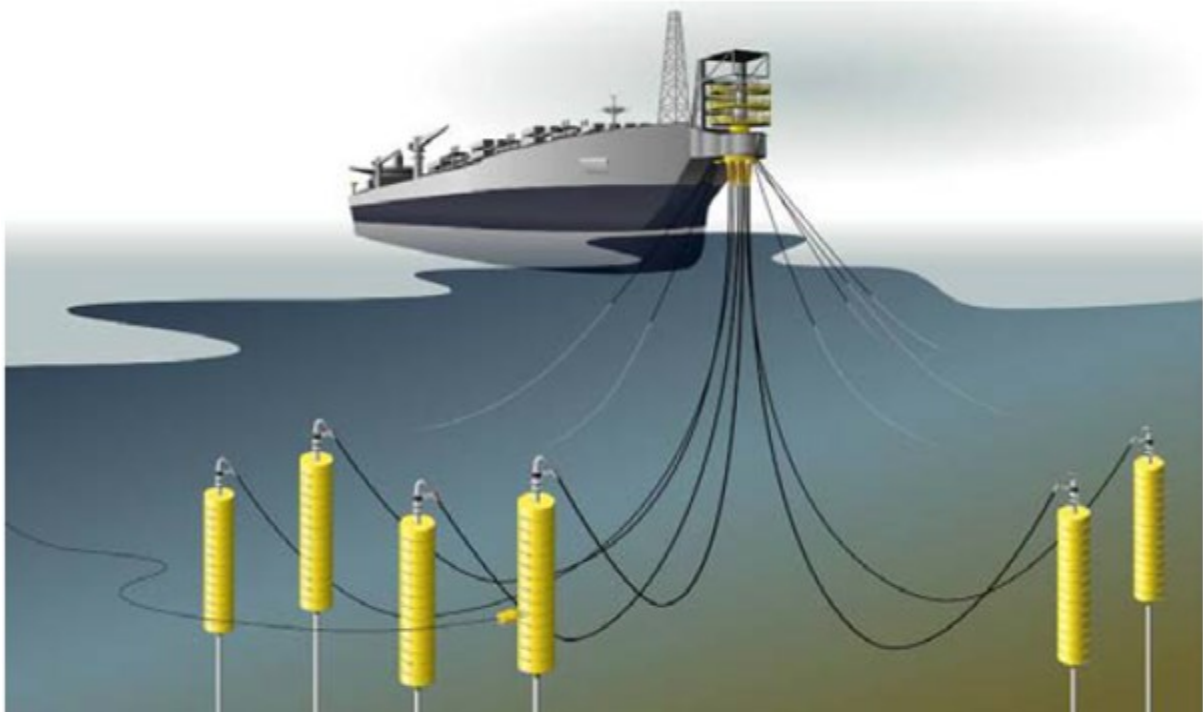
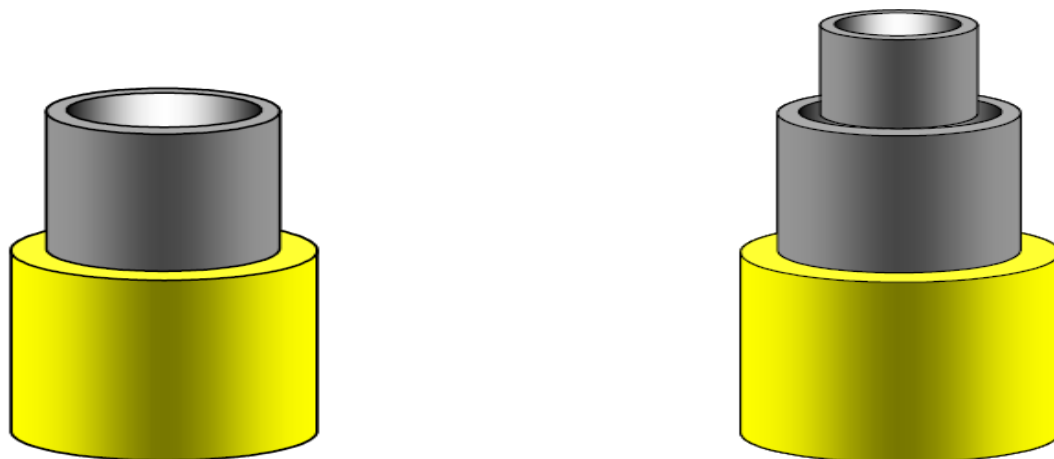

Figure 7.5 – SHRs Installed with External Turret FPSO [Tellier & Thethi, 2009]

First SHR was installed in year 2004 with Kizomba A FPSO and a year later another SHR was installed with Kizomba B FPSO both in Angola. Though both the SHRs had almost similar system components but the cross section of the riser was different as shown in Figure 7.6.



Kizomba A - SHR

Kizomba B - COR

Figure 7.6 – Cross-section of SHRs used in Kizomba A & Kizomba B [Tellier & Thethi, 2009]

From Figure 7.6 it is clearly visible that SHR of Kizomba A had a single pipe to transport fluids while Kizomba B SHR also called Concrete Offset Riser (COR) was a pipe in pipe solution. The need of COR for Kizomba B was due to requirements of gas lift during production. Hence the outer annulus was used for gas injection purpose while inner annulus to carry production fluid [Tellier & Thethi, 2009]. The key features of SHR are:

1. Single line risers each surrounded by wet thermal insulation
2. SHR steel riser pipes are either welded or mechanically connected to each other. In the former case these are installed from J lay tower of the installation vessel while in the latter case they are installed from drilling rig [Tellier & Thethi, 2009].
3. SHR is laterally offset from the floater unit.
4. All the SHRs installed with FPSO till date have a Rotolatch flexible joint connecting LRA and suction pile [Tellier & Thethi, 2009].

7.2.4 Buoyancy Supported Riser

The latest addition to hybrid riser family is Buoyancy Supported Riser (BSR) concept which consists of a large sub-surface buoy anchored to the seabed by 8 tethers, 2 on each corner of the buoy as shown in Figure 7.7 [Subsea 7, 2013].

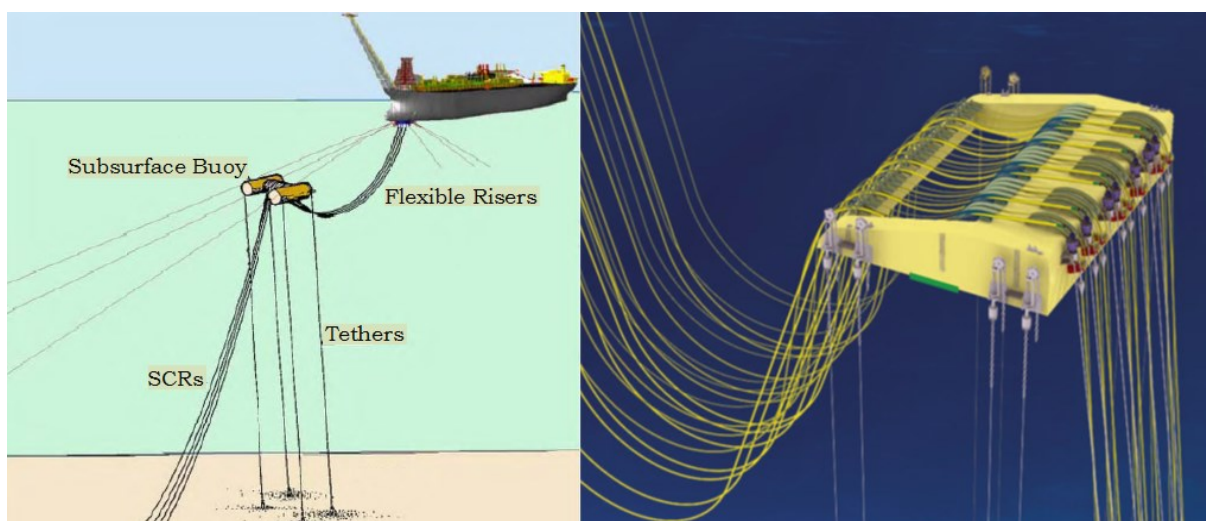

Figure 7.7 – BSR Arrangement and its Subsurface Buoy [Subsea 7, 2013]

As can be seen from Figure 7.7 that subsurface buoy acts as an interface to the CRA lined - SCR coming from seabed and flexible jumper/riser connected to the FPSO. Flexible riser absorbs the host vessel motions thereby reducing TDP motion of SCR and improving its fatigue life considerably. This concept offers additional advantage over FSHR as it does not require heavy assemblies and foundations which are expensive, complex to design and difficult to install.

First BSR installation was in Guaro Sapinhoa and Lula NE pre salt fields, offshore Brazil. High CO₂ and H₂S content along with high pressures at these fields required the use of novel BSR risers which were tied back to spread moored FPSO stationed at 2100m water depth. The subsurface buoy was placed 250m below the sea level, so that it is not exposed to wave and extreme currents [Subsea 7, 2013].

7.3 Components

Offshore industry is focusing on the standardization of the components used with Free Standing Hybrid Riser (FSHR). Hence whether it is HRT or SHR, emphasis is laid on using these standard components with minor modifications. In this section the components used with a typical SHR will be defined. Figure 7.8 shows two possible configurations of SHR with its components.

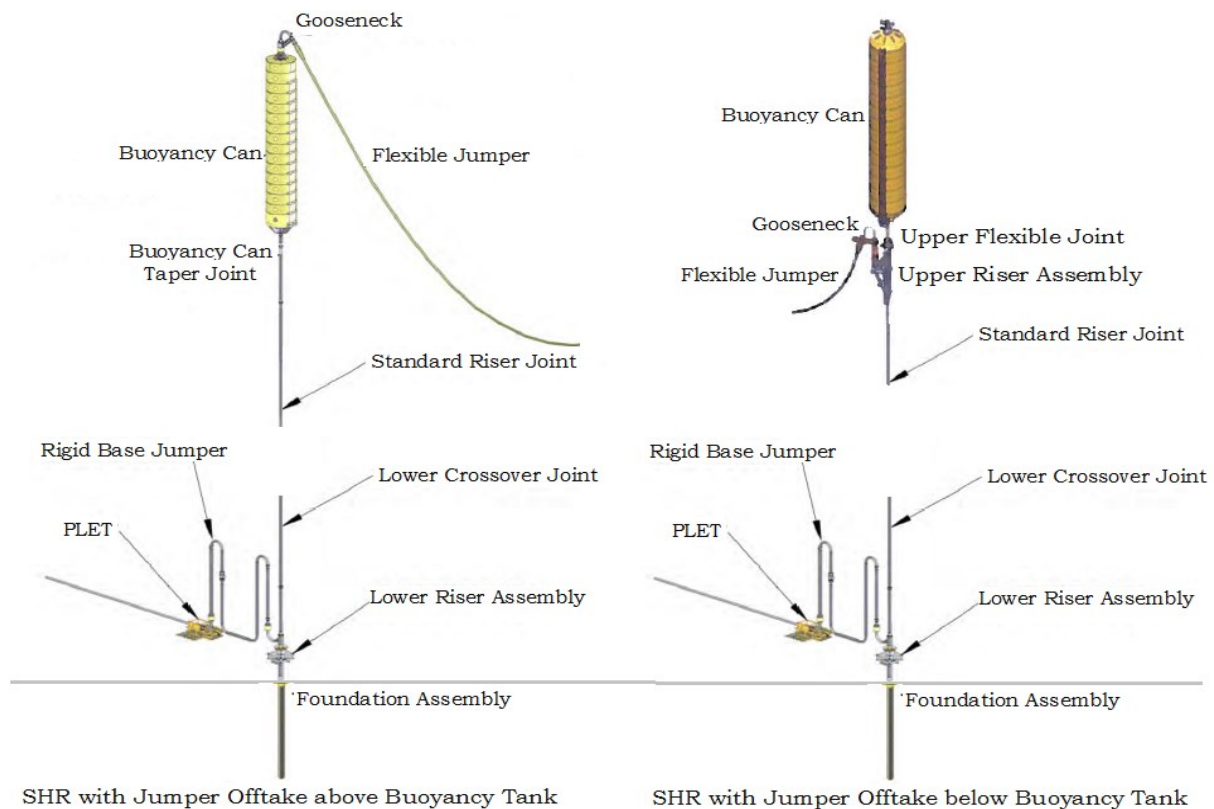

Figure 7.8 – Typical SHR arrangement and its Components [Eyles & Lim, 2006]

Some of the important components shown in Figure 7.8 are described below.

7.3.1 Foundation

It can be either a suction pile (anchor) or a drilled and grouted pile; however with all of the FSHRs installed with FPSO the former one has been used. Suction pressure is used to drive

suction anchors into the seabed to withstand the maximum vertical loads at riser base. Length, diameter and penetration depth of the suction anchor depends upon the soil conditions at site and tension requirements at the riser base.

Connection between riser base and foundation can either be rigid or flexible. The rigid connections have been used with first generation HRTs of Grand Canyon 29 and Garden Banks 388. These rigid connections were made up of modified collet connector and titanium stress joint to reduce bending loads on riser segment [Tellier & Thethi, 2009].

However in 2nd and 3rd generation FSHRs tied back to FPSO, elastomeric flexible joints with self-guiding and self-actuating Rotolatch connectors have been used. The male connector attached to lower portion of the Lower Riser Assembly (LRA) mates with the receptacle placed on the top of suction anchor as shown in Figure 7.9.

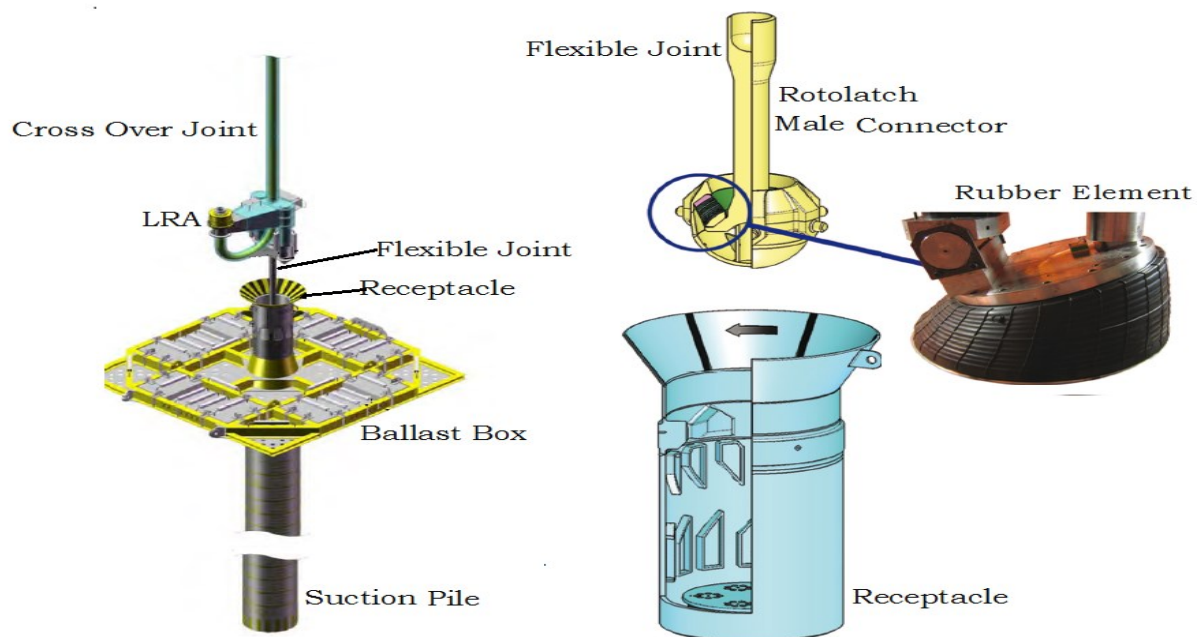

Figure 7.9 – Typical SHR Foundation Arrangement & its Flexible Joint [Eyles & Lim, 2006]

LRA consists of piping, lower offtake spool and associated tubular frame structure as shown in Figure 7.10.

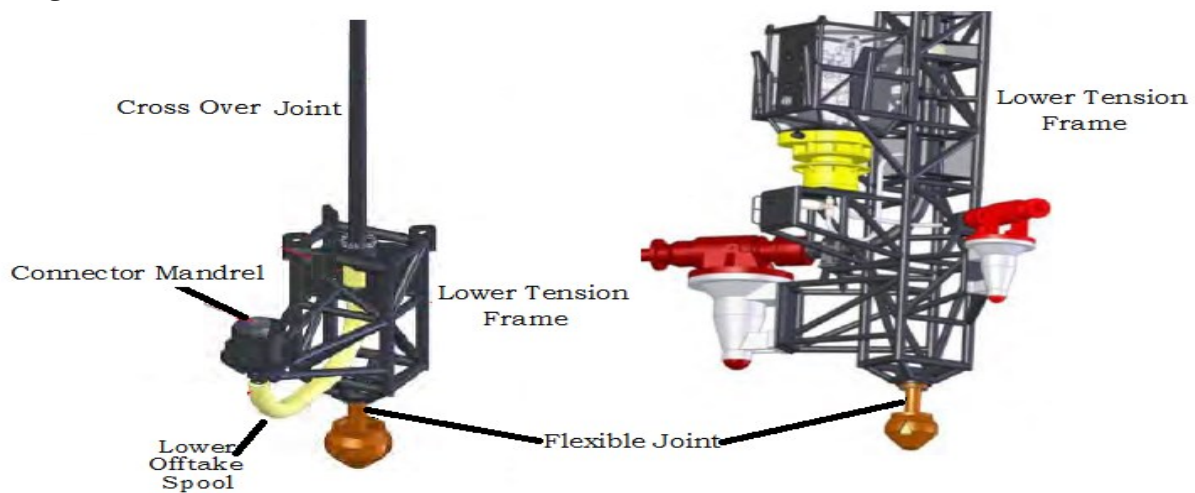

Figure 7.10 – Typical Lower Riser Assembly of SHR [Eyles & Lim, 2006]

7.3.2 Base Assembly

Two configurations of base assembly are possible. The first one shown in Figure 7.9 using a suction pile and Rotolatch flexible joint has been mostly used with SHR until date. However for this case the rigid base jumper must be designed to withstand the dynamic loads arising due to riser base rotation about the flex joint.

An alternate base assembly which reduces the dynamic loading on the rigid base jumper has been utilized with Semi-Sub P-52 export SHR. It consists of lower offtake spool connected to Taper Stress Joint (TSJ) at top end and to grouted pile at lower end via foundation connector. Thus lower offtake spool acts as an interface between riser base, foundation pile and rigid base jumper as can be seen from Figure 7.11.

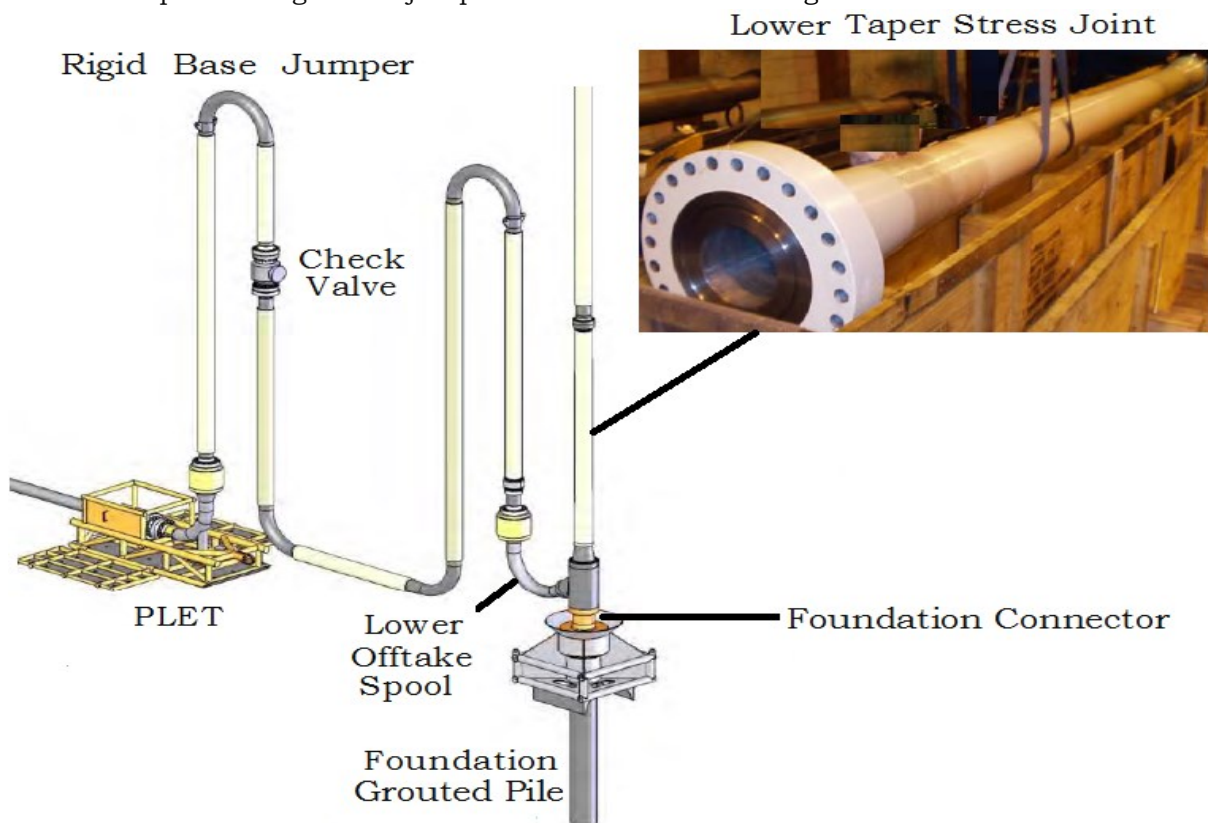

Figure 7.11 – Base Assembly of SHR [Eyles & Lim, 2006]

As can be seen from Figure 7.11 that lower end of TSJ is connected to lower offtake spool with the help of flanged connection. TSJ accommodates the large bending moments arising in the riser base due to host vessel offset and current impact thereby eliminating the dynamic loads on the rigid base jumper. However the rigid base jumper must be carefully designed and fabricated to accommodate the thermal expansion in flowline and riser due to startup and shut down operations.

The base assembly of HRT is more complex than SHR due to the need of terminating bundle of different types of risers like production, water injection etc. Large number of risers in a bundle will require larger offtake spool which in turn will require larger installation vessel for spool's installation. Hence effort must be made to minimize the number of risers in the bundle so that the design of base assembly is simplified and size of offtake spool is minimized [Marcoux & Legras, 2011].

7.3.3 Riser Strings

The riser strings are vertical steel pipes whose function is to carry the fluid from seabed to surface or vice versa. These can either be single line or pipe in pipe as discussed in section 7.2.3. Figure 7.6 shows two types of riser strings which are generally either welded or mechanically joined together. Major proportions of SHRs till date have utilized welding technique and have been installed by J lay tower of pipe lay installation vessel. But industry is now shifting its focus on mechanically connected risers employing Threaded and Coupled (T&C) connections due to following reasons:

- **Faster connection time** – For 10 inch diameter riser string T&C connection takes two to five minutes while welding takes thirty to fifty minutes [Maclure & Walters, 2006].
- **Reduced Riser Weight** – T&C connection allows usage of high strength steel pipe which offers reduced riser weight thereby mitigating vessel payloads and buoyancy requirements [Maclure & Walters, 2006].
- **Better fatigue Life** – The fatigue life of T&C connection is equal or better than good quality welded joint [Maclure & Walters, 2006].
- **Reduced Cost** – Though cost of T&C connection is larger than welding technique, but faster connection time and installation from drilling rig derrick renders considerable cost savings.

The riser strings in case of HRT are bundled together as discussed in section 7.2.3 and shown in Figure 7.4.

7.3.4 Buoyancy Tank

It is a compartmentalized steel tank which is filled with air/nitrogen to provide the necessary up thrust to keep the riser strings tensioned. Two designs of buoyancy tank are generally used depending upon the location of flexible jumper off take as shown in Figure 7.12.

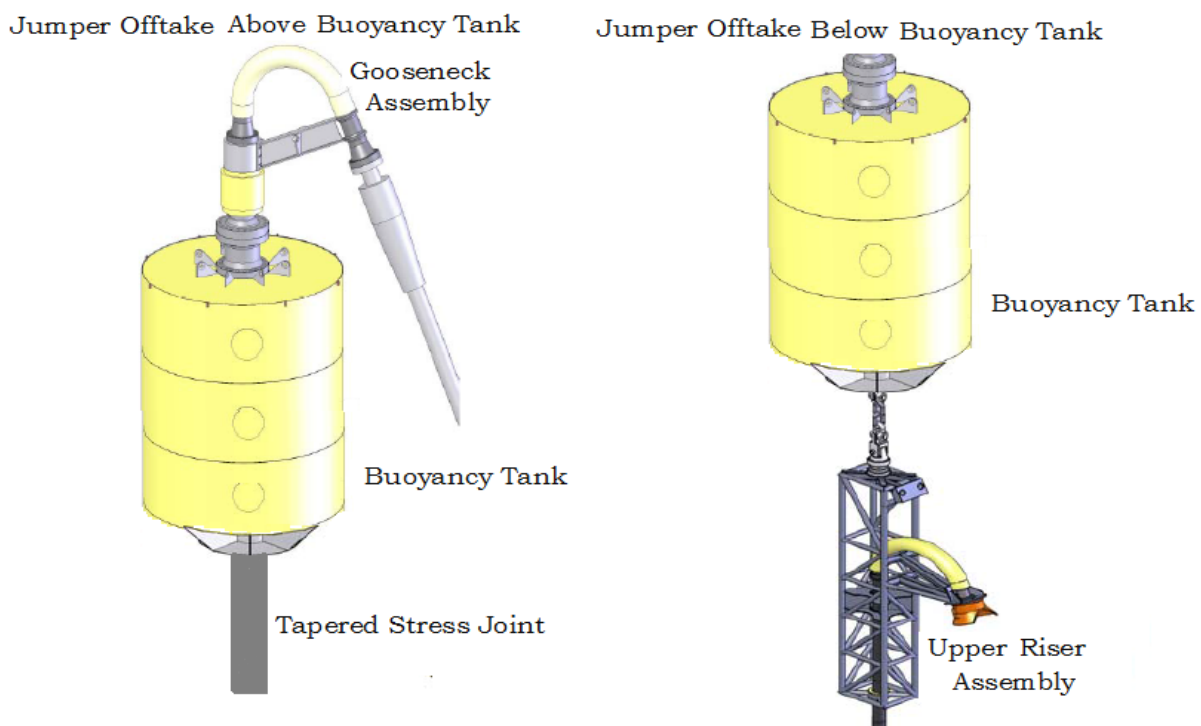

Figure 7.12 – Jumper Offtake Position Relative to Buoyancy Tank [Tellier & Thethi, 2009]

In case of jumper offtake below the tank, buoyancy can be simple compartmentalization of cylindrical structure with simple ballasting piping. However jumper offtake above the buoyancy tank requires a complicated inside geometry of tank consisting of the internal bulkheads dividing the tank into various compartments to limit its flooding in case of local damage as shown in left side drawing of Figure 7.13.

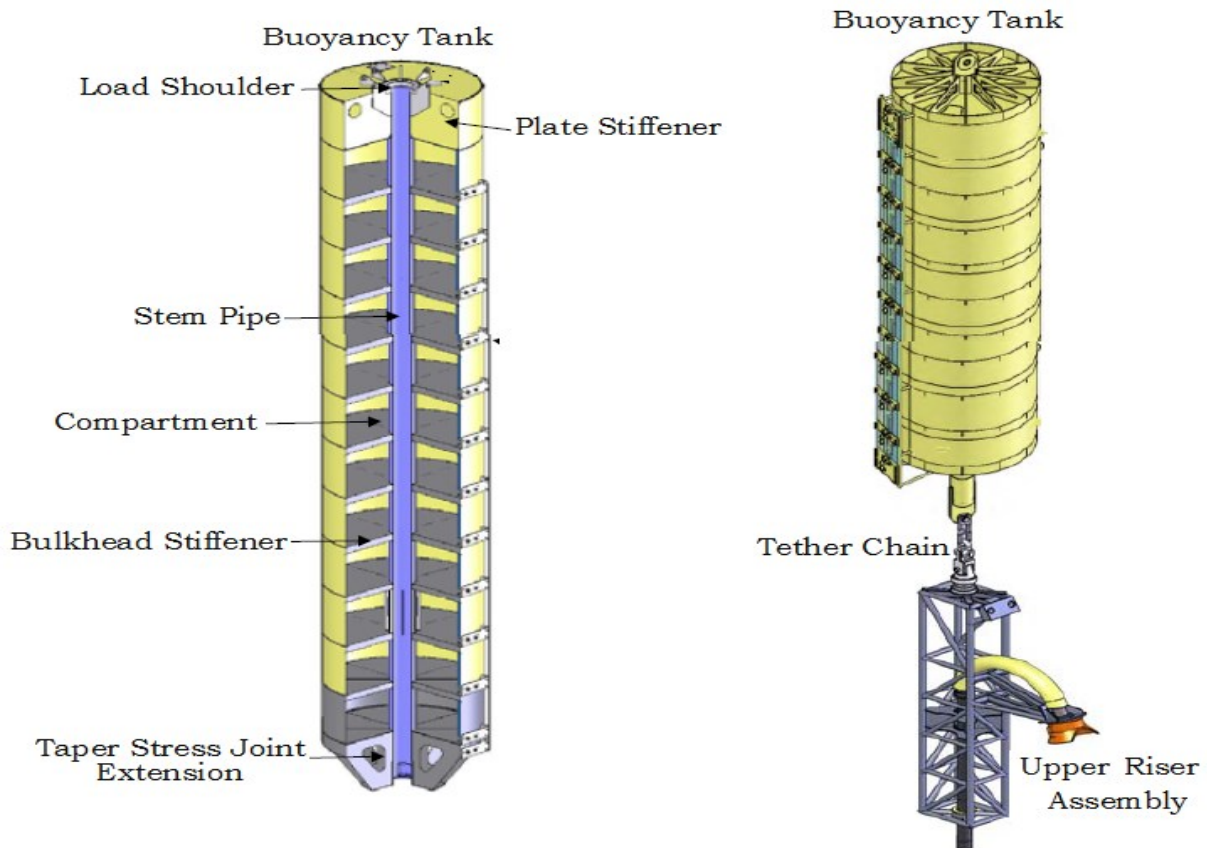

Figure 7.13 – Different Types of Buoyancy Tank [Subsea 7, 2013]

As can be seen from Figure 7.13 that in case of buoyancy tank having jumper offtake on its top, a central stem pipe runs through the center of the tank and provides necessary structural support. The riser string passes through the buoyancy tank and centralizers are used along the length of riser inside tank to maintain its position and curvature. Riser is attached to top of the tank by load shoulder which ensures that tension is generated at the top of the riser.

A TSJ is used at interface of riser string with the base of buoyancy tank to accommodate for high bending stresses due to vessel offset and current. Though by placing jumper offtake above the buoyancy tank, its geometry becomes complex but this arrangement has benefit of installing the flexible jumper by divers which is cheaper than installing them by vessel.

Till date all the SHRs installed with FPSO have used buoyancy tank with jumper off take below the tank for easier installation of the tank and jumper from the installation vessel. However HRTs generally use buoyancy tanks with jumper offtake above them.

7.3.5 Upper Riser Assembly/ Gooseneck Assembly

In case of jumper offtake located below the buoyancy tank Upper Riser Assembly (URA) is used as shown in Figure 7.13. URA acts as in interface between the flexible jumper, rigid

riser string and buoyancy tank. Just like LRA it also consists of tubular frame structure and piping.

For the buoyancy tank having jumper take off above it, URA is replaced by gooseneck assembly as shown in Figure 7.12. It provides fluid transfer between riser and flexible jumper. Figure 7.14 shows URA and gooseneck assembly used with FSHRs.

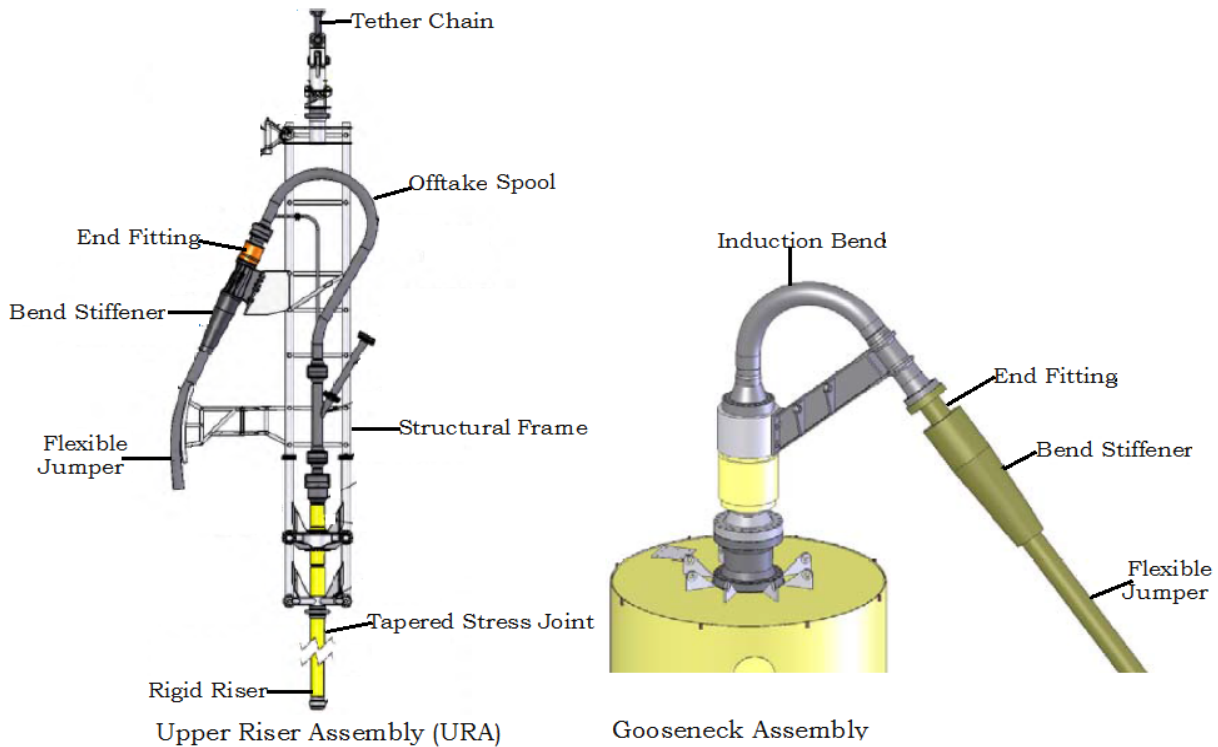

Figure 7.14 – Different Types of Buoyancy Tank [Subsea 7, 2013]

7.3.6 Flexible Jumper

It is unbonded flexible pipe whose function is to transport fluid from the rigid riser string to the piping on the host vessel. The properties of jumper depend upon the requirements like insulation and service. And they must be placed such that they don't interfere with each other during operation phase.

7.4 Design

Due to numerous components and hybrid nature several design codes and industry specifications are required for hybrid risers. Some of the codes and specifications used for designing FSHR are shown in Table 7.2.

Component	Industry Specification/Code
Flexible Pipe	API 17J & API RP 17B
Steel Product Lines	DNV-OS-F201, API RP 2RD & API RP 1111
Buoyancy Tank	API Spec 2B, API Spec 2H & API RP 2A
Foundation	API RP 2T & API RP 2A
Buoyancy Module (Syntactic foam)	ASTM
Polymers	ASTM (material specific)

Table 7.2 – Industry Specification for FSHR [Sworn, 2005]

As can be seen from Table 7.2 that large number of design standards are applicable to hybrid risers hence it is vital to maintain compatibility between various standards. This compatibility is necessary especially when the design loads are being transferred from global analysis (done according to API-RP-2RD or DNV-OS-F201) to local structural models like buoyancy tank model which is analyzed using API-RP-2A [Andrew & Eyles, 2010]. Also apart from extreme and fatigue analysis additional clearance analyses needs to be done for hybrid risers to ensure that adjacent riser and flexible jumpers are not interfering with each other.

Though design principles of various hybrid riser configurations are almost same but the design approach focused on critical issues may differ. For example for 2nd generation hybrid bundle one of the critical design issues is difference in thermal expansion of product and service lines gathered in single bundle. Whereas this is not a problem for SHRs as each line is individually positioned and thus free to expand irrelative of each other. However some of the key design drivers for SHR are [Luffrum & Lim, 2009]:

- **Size of Buoyancy Tank:** One of the factors governing the size of the buoyancy tank is the up thrust required on the riser string such that no compression occurs in riser segment during testing and operation phase. Another factor which decides the diameter of buoyancy tank is the construction and installation limitations of the site where these are manufactured.
- **Depth of Buoyancy Tank:** The buoyancy tank should be placed at a water depth where the effect of wave and current is minimal on it. At the same time if it is placed too below the sea level then length of flexible jumper would be increased and diver access for inspection would not be possible.
- **Flexible Jumper Length:** The length of flexible jumper is governed by factors like buoyancy tank depth, riser offset from host vessel, extreme vessel offset and motion of riser due to loads imposed by current. Since flexible jumper is an expensive item so its length cannot be increased too much. Also large length of jumper could exceed minimum bending radius criteria at the sag bend. At the same time too short jumper can impose high tension in it and hang off angles can become too high to be accommodated by bend stiffener at both ends. Hence jumper length should be carefully decided upon.
- **Offset from Vessel:** The offset distance of SHR from the vessel is dependent upon factors like extreme vessel excursion envelope, current loads imposed on the riser and field layout.
- **Tension Required at Base:** It is governed by factors like fatigue life of the riser and riser deflection. High tension in the riser base decreases the deflection in the riser thereby improving the clearance between various adjacent risers.

It must be noted that riser design codes like API RP 2RD and DNV-OS-F201 which are deemed necessary to design rigid risers, provide little guidance for designing and constructing FSHR [Sworn, 2005]. With the passage of time industry is gaining experience related to hybrid risers which can be used along with codes mentioned in Table 7.2 to come up with a dedicated hybrid riser specifications and standards.

7.5 Current Trend & Future

Till date most of the hybrid risers tied back to FPSO have been installed in benign environments of WoA. However in the past three years they have been installed with FPSO in moderate environments of Brazil (2 fields having BSR) and harsh environments of US GoM (1 field having SHR).

In terms of water depth these have been installed till 2500m in Cascade and Chinook project in US GoM. Figure 7.15 shows the water depth capabilities of hybrid risers along with the year in which the operation started. Figure includes hybrid risers (HRT, SHR & BSR) installed with deepwater FPSOs worldwide.

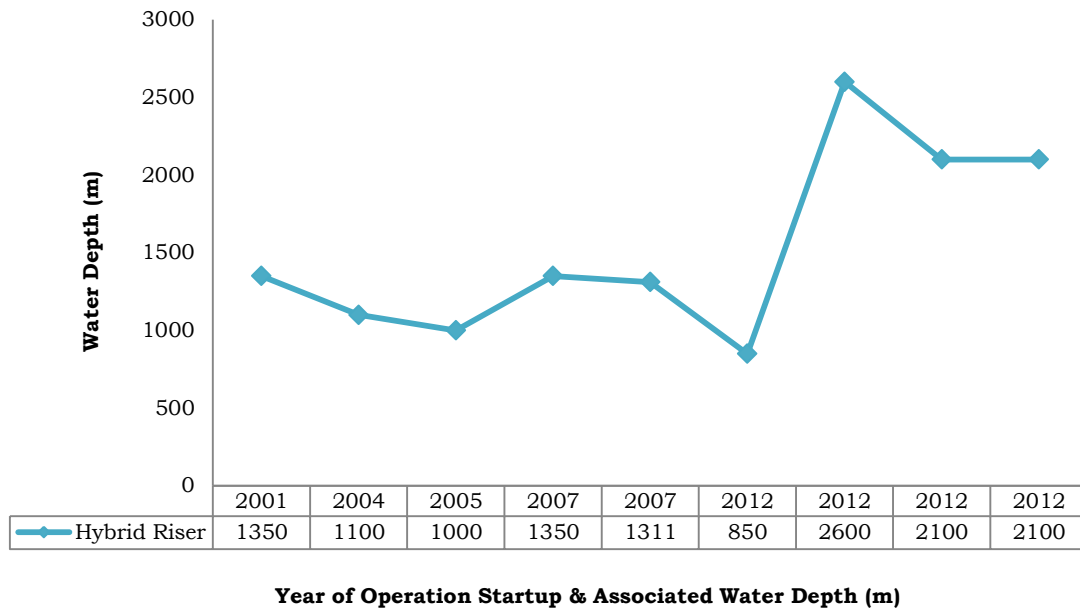

Figure 7.15 – Water Depth Capabilities of Hybrid Riser with Years of Starting Operation

Note: Hybrid risers of CLOV field have not been included as the field is expected to start production in mid-2014.

From Figure 7.15 it is clearly depicted that hybrid risers have been mostly used for deepwaters and with the passage of time their water depth capabilities have increased. Currently three main types of hybrid risers namely HRT, SHR and BSR are being used with deepwater FPSOs. From Table 4.1 presented in the chapter 4 of this thesis it can be seen that at present SHRs dominates the hybrid riser concept selection. However for the fields requiring large number of SHRs, their congested field arrangement and resulting clashing becomes a major problem. Hence to make field arrangement more systematic and to prevent clashing of adjacent risers a new concept called as Grouped SLOR can be used.

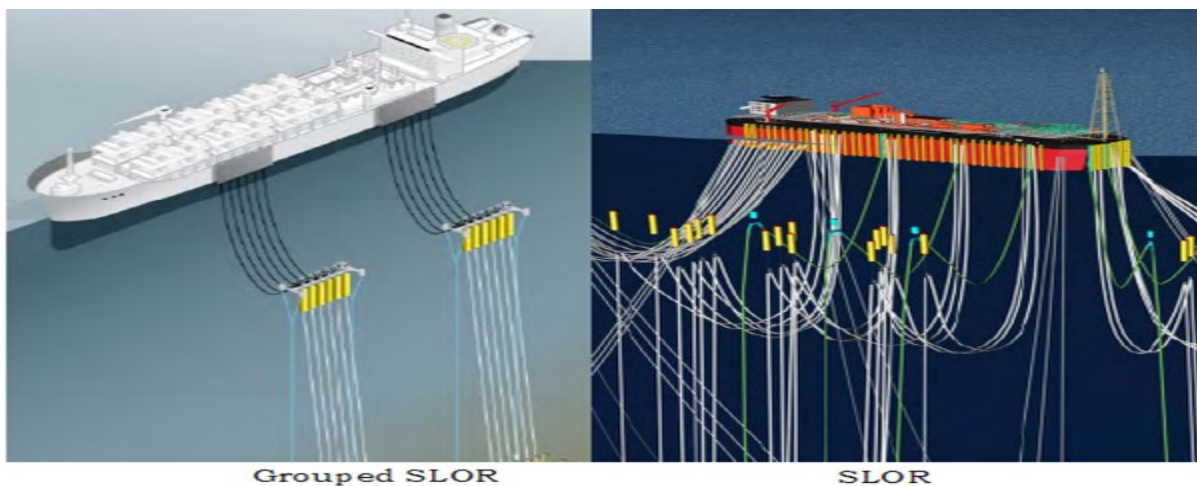
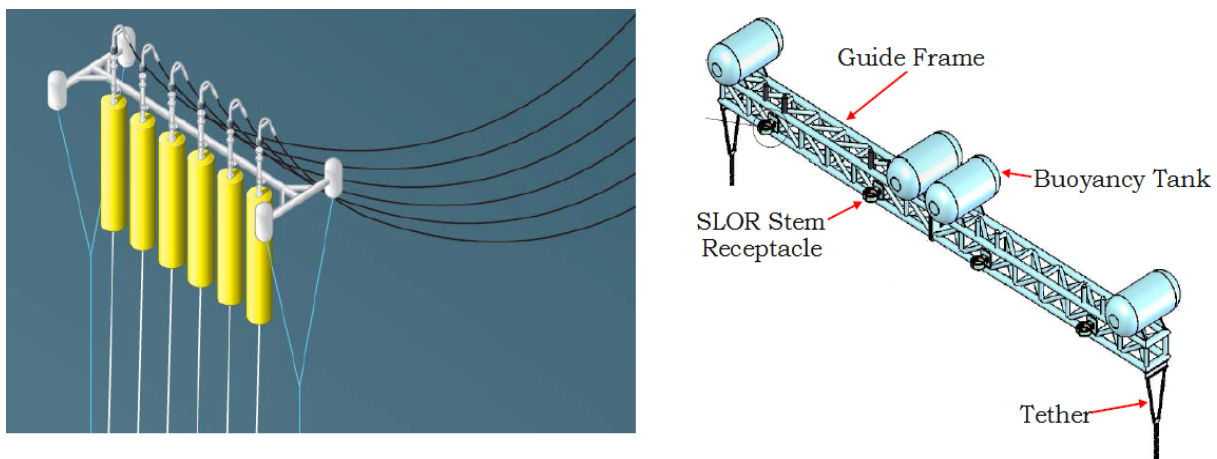

Figure 7.16 – Grouped SLOR vs SLOR Field Layout & Jumper Tieback Comparison [Subsea 7, 2013]

Grouped SLOR: It is an open bundle riser solution which has been developed with the aim of preventing riser clashing, optimizing riser interface with host platform and providing better access for riser inspection [Karunakaran et al, 2007].

Grouped SLOR consists of number of SHRs held together at a suitable distance with the help of guide frame so that no clashing occurs between them during installation, testing, operation, inspection and removal. The SHRs of Grouped SLOR are similar to standard SLORs/SHRs described in section 7.3 however there are two main differences. The first difference lies in the jumper offtake which in case of Grouped SLOR is above the buoyancy tank while in case of standard SHR is below the tank.

The second difference is that in Grouped SLOR the central stem of buoyancy tank is elongated from tank's top to the top of the guide frame. The riser passes through this central guide stem until it reaches the top of guide frame where it is connected to the gooseneck assembly. Receptacles on the guide frame are used to hold these elongated stems whose length depends upon the maximum riser stroke relative to guide frame during riser's entire service life [Karunakaran et al, 2007]. Figure 7.17 shows the top arrangement and guide frame of Grouped SLOR.



Grouped SLOR Top Arrangement Details

Figure 7.17 – Grouped SLOR Top Arrangement [Karunakaran et al, 2007]

As can be seen from Figure 7.17 that each guide frame has a buoyancy tank welded to it which provides necessary up thrust to the frame during operation and installation phase. The amount of water displaced by frame is directly proportional to the water depth and generally varies from two percent to six percent of water depth for water depths between 800m to 2000m [Karunakaran et al, 2007].

Since Grouped SLOR is an assembly of large number of individual SLORs so it is obvious that its response depends on the response of individual SLORs. Hence for a good response of Grouped SLOR the positioning of the SLORs on the guide frame should be carefully done so that the loads on guide frame are balanced.

The Grouped SLOR seems to be a promising riser concept for deepwater developments, especially having congested seabed layout immediately close to the host platform. It offers the advantages of SLOR/SHR and also assures simpler seabed layout. Number of qualification programs have been carried out to test the robustness and design of the concept for their usage in deepwater environments [Subsea 7, 2013].

COBRA: Another new un-coupled riser concept called as Catenary Offset Buoyant Riser Assembly (COBRA) is the improved variant of “Catenary Bundle Riser” developed by Subsea 7 in early 2000 [Karunakaran and Baarholm, 2013]. COBRA consists of a SCR section with long, slender buoyancy can on top which is tethered down to seabed by 2 mooring lines. The connection between SCR and flexible jumper connected to the host vessel is made on top of the buoyancy can which is placed at a particular water depth to escape effects of wave and high current. Typical COBRA riser arrangement is shown in Figure 7.18.

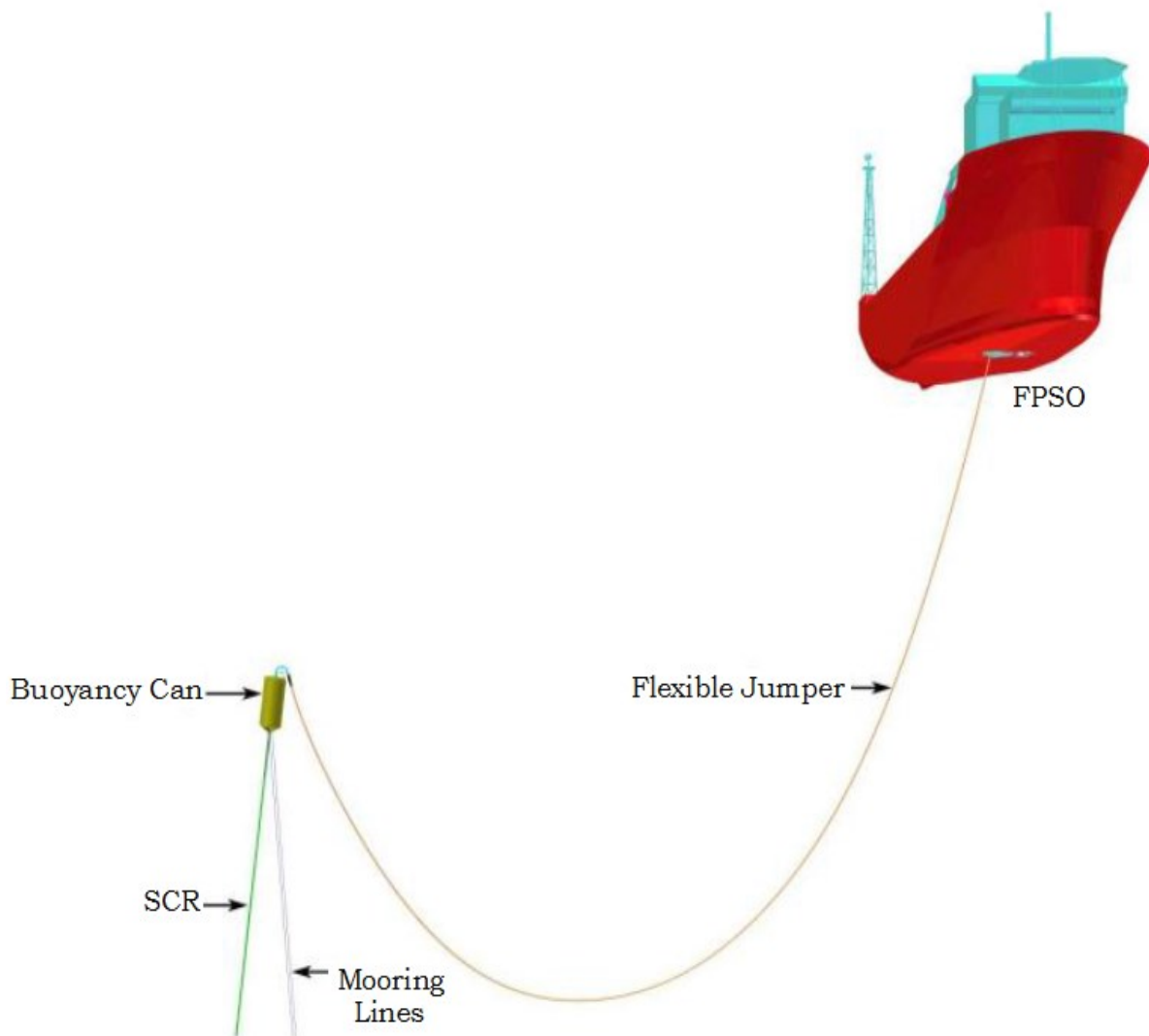

Figure 7.18 – Typical COBRA Riser Arrangement [Karunakaran and Baarholm, 2013]

As can be seen from Figure 7.18 that like other hybrid riser concepts the flexible jumper takes most of the vessel motions thus improving both strength and fatigue performance of the overall system.

When compared to HRT and SHR concepts COBRA has an added advantage of avoiding expensive base and foundation assemblies. This makes design and installation of COBRA relatively simpler than HRT and SHR. In addition COBRA offers excellent dynamic performance with very less fatigue damage at hang off and TDP of SCR, thus allowing the design of SCR for pipeline class welds [Karunakaran and Baarholm, 2013].

Tethered Catenary Riser: Tethered Catenary Riser (TCR) is a novel riser concept which is an improved version of already field proven BSR. TCR whose components are almost similar to BSR differs from it mainly in two ways. The first is the shape of the sub surface buoy and the second one being the tethering system of the buoy Figure 7.19 shows sub surface buoys of TCR.

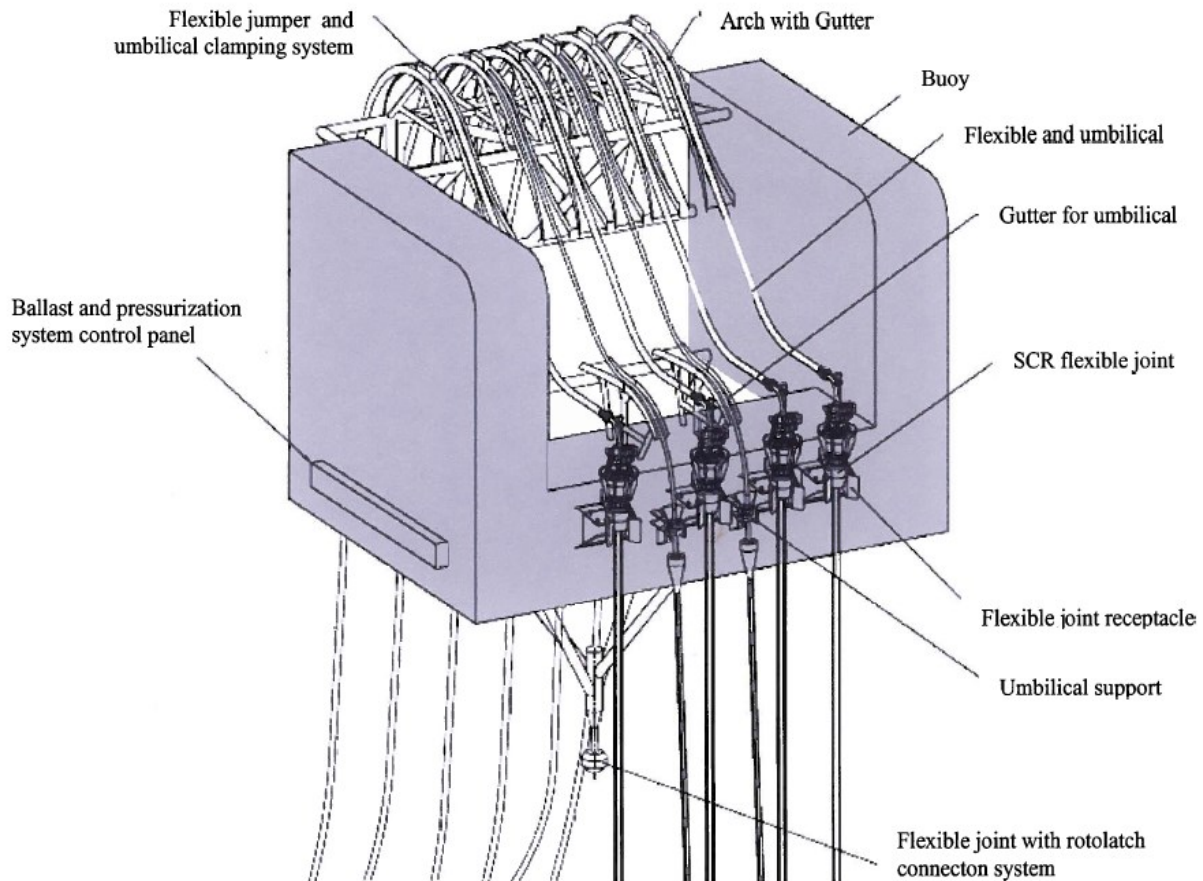

Figure 7.19 – Schematic of Subsurface Buoy of TCR [Legras, 2013]

From Figure 7.7 it can be seen that the tethering system for buoy in case of BSR consists of 8 tethers, 2 on each corner of the buoy. While from Figure 7.19 it can be seen that in case of TCR tethering system consists of a single tendon pipe (generally seamless X65 pipe) connected to the bottom of buoy by Upper Tendon Assembly (UTA) which consists of flexible Rotolatch connector. Thus TCR has edge over BSR in terms of simpler tethering mechanism along with easier installation method [Legras, 2013].

Figure 7.19 also depicts that buoy of TCR consists of tubular frames and gutters to support and guide jumpers and umbilicals. A special connection system called Angle Connection Module (ACM-patent pending) similar to one used with BSR connects flexible jumpers with the flex joint on top of SCRs. Rest of the components and working principle of TCR is quite similar to BSR and hence can be seen as future replacement to already field proven BSR.

Both TCR and COBRA are yet to be field proven but they are apt for FPSO in deepwater harsh environment and offer all the benefits of an un-coupled riser system. In addition both concepts allow larger step-out distance between FPSO and subsea well which makes them a promising concept for deepwater harsh environments [Karunakaran and Baarholm, 2013].

Deep Steep Riser: Another novel riser concept called as Deep Steep Riser (DSR) system is currently being analyzed for technical feasibility and cost assessment. A 3D artistic view of the riser system is shown in Figure 7.20.

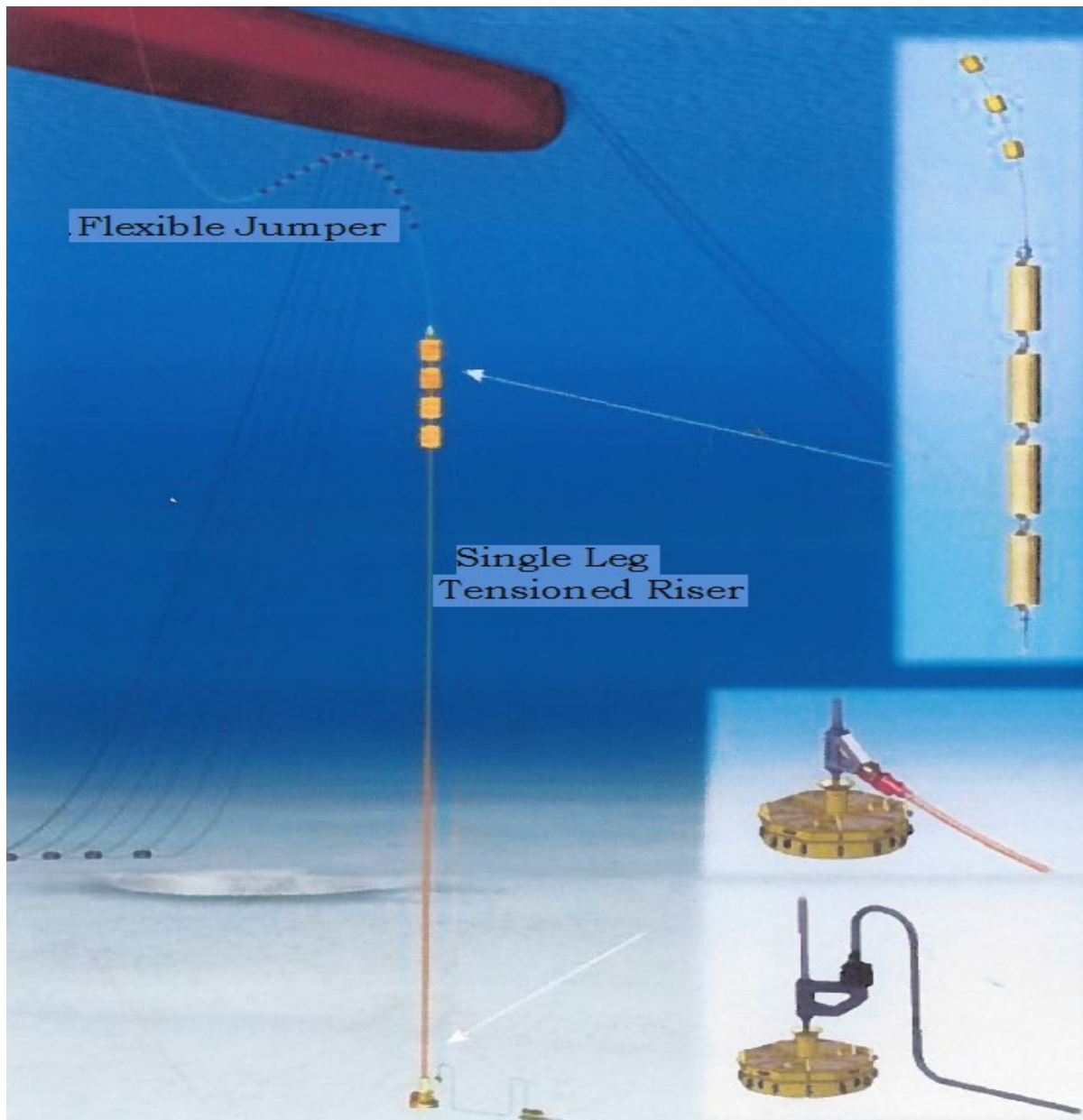

Figure 7.20 – Deep Steep Riser Arrangement, 3D Artistic View [Lupi et al, 2014]

As can be seen from Figure 7.20 that steep wave flexible riser forms upper part of DSR while single leg tensioned riser (flexible or rigid) forms lower portion. Different cross sectional design of risers are being studied for both the sections of the riser in order to get optimized weight and design of the riser [Lupi et al, 2014].

Full flexible DSR consisting of 6" ID and Carbon Armor Layers is currently being developed for its application in water depths exceeding 3000m [Lupi et al, 2014]. Also hybrid DSR systems for 11" ID is being developed for water depths up to 4000m. Hence the future of riser technology is targeting deeper waters and aims for reducing vessel payloads, fatigue damage and costs are considered vital.

7.6 Advantages & Limitations

7.6.1 Advantages

- 1. Low Vessel Payload:** Since hybrid risers are un-coupled solutions with most of the load of rigid riser being taken by sub-surface buoyancy tank, so they impose very less vessel payloads when compared to flexible and steel riser. Even for water depths exceeding 2500m the load due to increased rigid riser length is compensated by increasing the size of buoyancy tank thus keeping the vessel payload minimal.
- 2. Excellent Fatigue Response:** As most of the floater motions are taken by the flexible jumper so the dynamic response of the rigid riser is minimal and hence the fatigue life is much higher than SCRs.
- 3. Early First Oil:** Hybrid risers can be installed prior to arrival of the floater unit which allows the first oil to be produced early and thus adding to cost efficiency.
- 4. Excellent Insulation Properties:** With hybrid risers having wet insulation of 150mm thickness an OHTC of 1.7 W/m²K can be achieved with minimal riser dynamics [Marcoux & Legras, 2011]. This favors the use of hybrid risers from flow assurance point of view.
- 5. Easy Installation:** HRTs are generally towed to site and upended at the site, while most of SHR are installed from the J-lay tower of the installation vessel. Both of these methods are well proven in offshore industry and therefore easy to accomplish.
- 6. Large Local Content:** Construction of hybrid riser unlike flexible riser is generally carried out in local yard which involves large number of local workforce. Thus providing employment opportunities to the local workforce.
- 7. Simplifies Field Layout:** Since HRT has all the risers gathered in a bundle so they are suited for congested field layout where flexible risers and SCRs can't be used. Even SLOR when used as Grouped SLOR can improve the field layout.
- 8. Less Severe Slugging:** Because of use of top flexible jumper section, the severe slugging in rigid section of hybrid risers is broken down into smaller slugs and thus results in less severe slugging when compared to SCRs.
- 9. Large Number of Contractors Available:** Unlike flexible riser which has only five manufacturers in the world, hybrid risers can be fabricated and installed by large number of contractors. This is especially highly cost efficient for operators as large number of contractors offer varying prices due to competition.
- 10. Wide Range of Applicability:** There is no known limit of water depth and pressure with which hybrid riser can be used which means they can be used in ultra-deep water as well [Marcoux & Legras, 2011].
- 11. Standardized Components:** Most of the components used in HRT and SHR are being standardized which lowers the requirement of equipment qualification testing.

7.6.2 Limitations

- 1. High Cost:** Due to requirement of expensive bottom assemblies the overall cost of the hybrid riser is several times higher than SCRs and even higher than flexible risers.
- 2. Complex Bottom Assemblies:** The bottom assemblies of HRT and SHR are difficult to design and are very bulky. Due to their large size installation seems to be a big a hassle especially for SHR.
- 3. High Risk of Failure:** Since all the production and service riser are bundled together in HRT so failure of the core structural core pipe increases the risk of failure of the entire riser system.
- 4. Clashing Issues:** Due to difference in stiffness of the production risers, gas lift risers and umbilicals their response to the wave and current loading is different. And if large numbers of these risers are bundled together in HRT then chances of clashing is high. Also large number of SHRs placed together can be subjected to clashing.
- 5. Inability to Inspect:** For 1st and 2nd generation HRTs the production and service lines are placed inside the foam module which restraints their visual inspection.
- 6. High Installation Fatigue:** For HRTs which are generally towed to site, the fatigue due to towing operation can be extremely high for harsh weather conditions of Northern Norwegian Sea, due to which they can't be installed at sites located in such harsh weather conditions.

7.7 Discussion & Conclusion

The key conclusions that can be made from the chapter are:

- 1.** Currently three configurations of hybrid risers namely Hybrid Riser Tower, Single Hybrid Riser (single pipe & COR) and Buoyancy Supported Riser have been installed with FPSO in deepwater up to 2500m.
- 2.** Most of the hybrid risers have been installed in deepwater fields of WoA having benign environment. The only exception to this are SHRs located in Cascade and Chinook field in US GoM and BSRs located in 2 pre salt fields located in Santos Basin of Brazil.
- 3.** HRT and SHR require complex, bulky and expensive bottom assemblies. Most of the HRTs till date have been beach fabricated, towed to site and upended.
- 4.** All of the SHRs have been installed by J-lay tower of installation vessel.
- 5.** Main advantages of hybrid risers are reduced vessel payload, robustness, better dynamic performance, low operational fatigue, high local content and optimum field layout.
- 6.** Main disadvantages of hybrid riser are high cost, bulky bottom assemblies and clashing issues amongst adjacent risers, jumpers and umbilicals.
- 7.** The future of hybrid risers involves use of novel concepts like Grouped SLOR, COBRA and Tethered Catenary Riser.

8 CASE STUDY

8.1 Purpose and Scope

Till date there are no FPSOs stationed in water depth of 1500m in North Sea, Norwegian Sea and Barents Sea. Owing to harsh weather conditions prevalent in the region disconnectable turret moored FPSO seems to be a promising floater unit because of various advantages discussed under section 2.2.5 of this thesis. For this case study internal disconnectable turret moored FPSO is chosen over external turret. The reason for this is due to less pitch motions of internal turret moored FPSO than external one which leads to less dynamic response of riser and hence better fatigue life.

The main purpose of the case study is to compare the riser systems feasible with internal turret moored FPSO in deepwater (1500m) and harsh weather conditions of Northern Norwegian Sea. The comparison is done on basis vessel payload, fabrication cost, installation cost and in the end suitable riser concept is recommended.

Based on the discussion and data presented in chapter 3 and chapter 4 of this thesis it can be said that free hanging flexible riser and SCR are not suitable for deepwater harsh environments. This is due high dynamic response of riser induced by FPSO which can cause its considerable fatigue damage at hang off and TDZ. Therefore these riser concepts are not considered in the case study.

The hybrid riser concepts like SHR/HRT are robust and have very less fatigue damage during operational phase even when used with FPSO in deepwater harsh environments. However HRTs are generally towed to offshore site and this could lead to considerable installation fatigue in harsh environments thereby limiting their use in such extreme conditions. Due to this reason till now most of hybrid risers have been installed in calm environmental conditions prevalent in WOA. So due to their limited experience of installation and operation in harsh environments and also owing to complexity in the design they will not be considered in the case study as well.

Hence lazy wave flexible riser and SLWR are the two most feasible riser concepts for this case study as both of these have been installed with FPSO in deepwater(>1500m) and moderate environment of Santos Basin which qualifies them for analysis in the case study. Main aim of this case study is to compare the two riser concepts on basis of vessel payload, fabrication cost and installation cost.

The scope of study involves performing static, dynamic and fatigue analysis of both the riser systems by using Orcaflex which is a 3D nonlinear time domain finite element program developed by Orcina. Details and modelling technique used by Orcaflex can be found in Appendix D. However analysis methodology used in the case study is in accordance to DNV-OS-F201 and is discussed next.

8.2 Analysis Methodology

8.2.1 General

Before performing the analysis of riser it is necessary to understand the theory behind it. A lot of input parameters like wave data, current data, RAO data etc. are required to perform the analysis. Hence each of these parameters is discussed next.

8.2.2 Waves

Wave loads are most critical from riser design point of view, hence a better understanding of waves is required to calculate and analyze their impact on the risers. Generally two different approaches can be used to do so. The first approach is called as single wave method while the other one used in this case study is called as wave spectrum method. Before discussing the wave spectrum method in detail it is important to explain a bit about different type of waves. The waves can be categorized as:

- Regular Wave:** A mono directional group of waves characterized by constant amplitude and frequency is termed as regular wave. This can further be divided into linear wave or nonlinear wave depending upon its steepness. While linear waves like airy waves have small steepness and resemble a sinusoidal curve, nonlinear waves on the other hand are characterized by large steepness. Thus they have peaked crest and flat troughs as in Cnoidal waves shown in Figure 8.1.

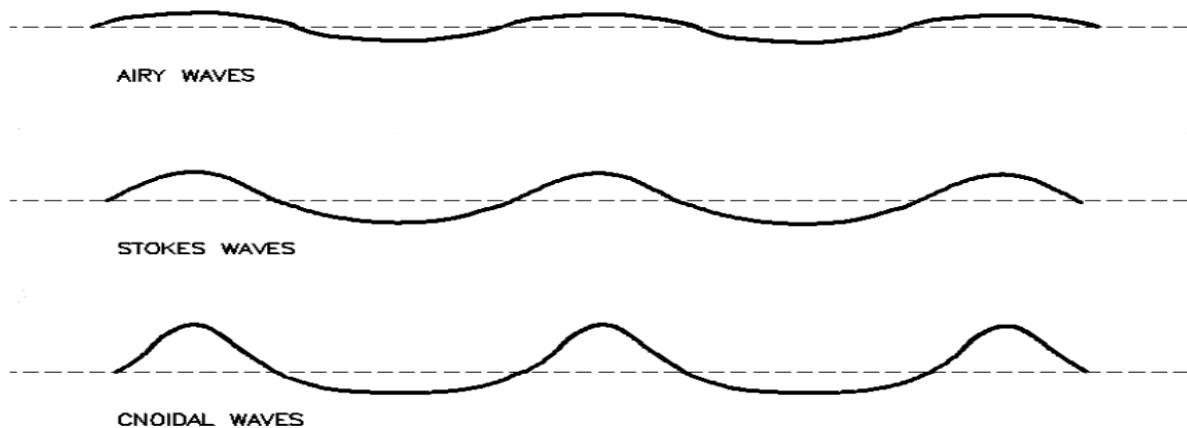

Figure 8.1 - Regular Wave Profiles [Chakrabarti, 2005]

- Irregular Wave:** It is composed of large number of random waves having different wave heights and wave periods. This wave is used to represent the actual ocean environment and is best modelled with the help of wave energy spectrum which depicts the wave energy distribution at different wave frequencies as shown in Figure 8.2.

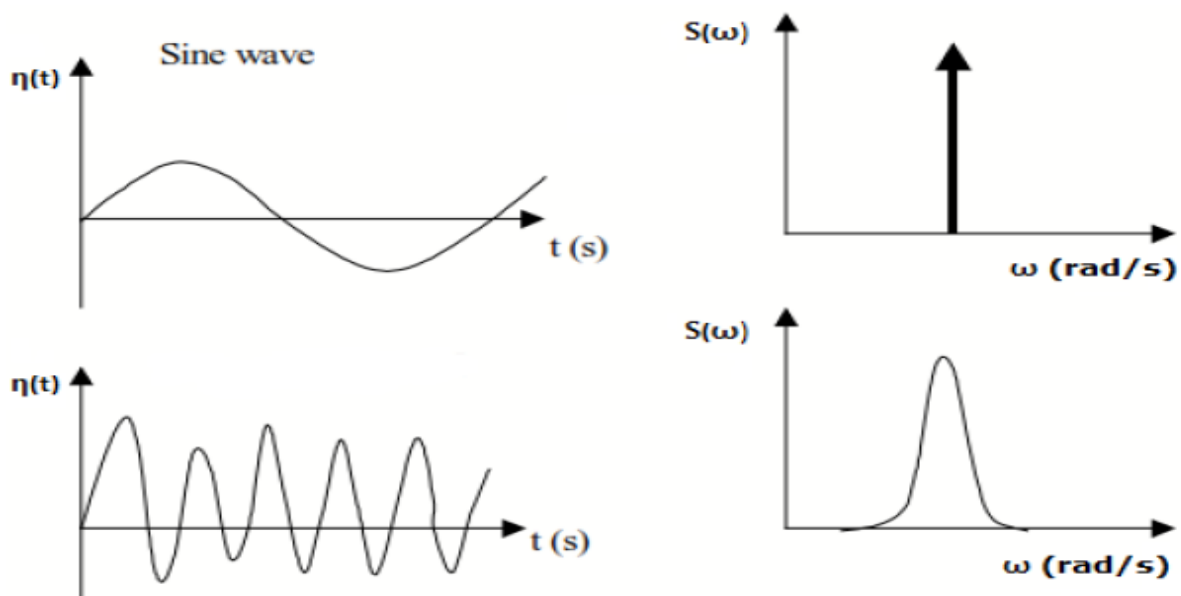

Figure 8.2 - Time Histories and Associated Spectral Shapes [Chakrabarti, 2005]

8.2.3 Wave Energy Spectrum

It uses Fourier series to superimpose a large number of irregular waves to represent the real ocean environment. Time history of random wave is shown in Figure 8.3.

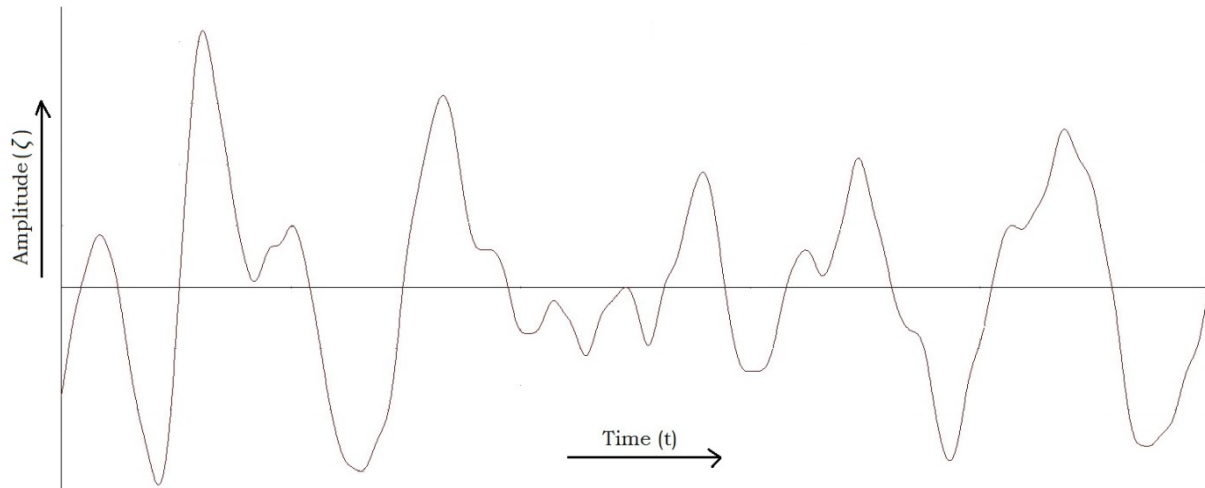

Figure 8.3 - Time History of Random Wave

The energy of the harmonic wave shown in Figure 8.3 is proportional to the square of amplitude and in order to find the distribution of wave energy with different frequencies a function $S(\omega_n)$ called as wave spectrum is used, where

$$S_{\zeta}(\omega_n) \cdot \Delta\omega = \sum_{\omega_n}^{\omega_n + \Delta\omega} \frac{1}{2} \zeta_{a_n}^2(\omega)$$

The wave spectrum as shown in Figure 8.4 is used to represent sea state which consists of large number of irregular waves.

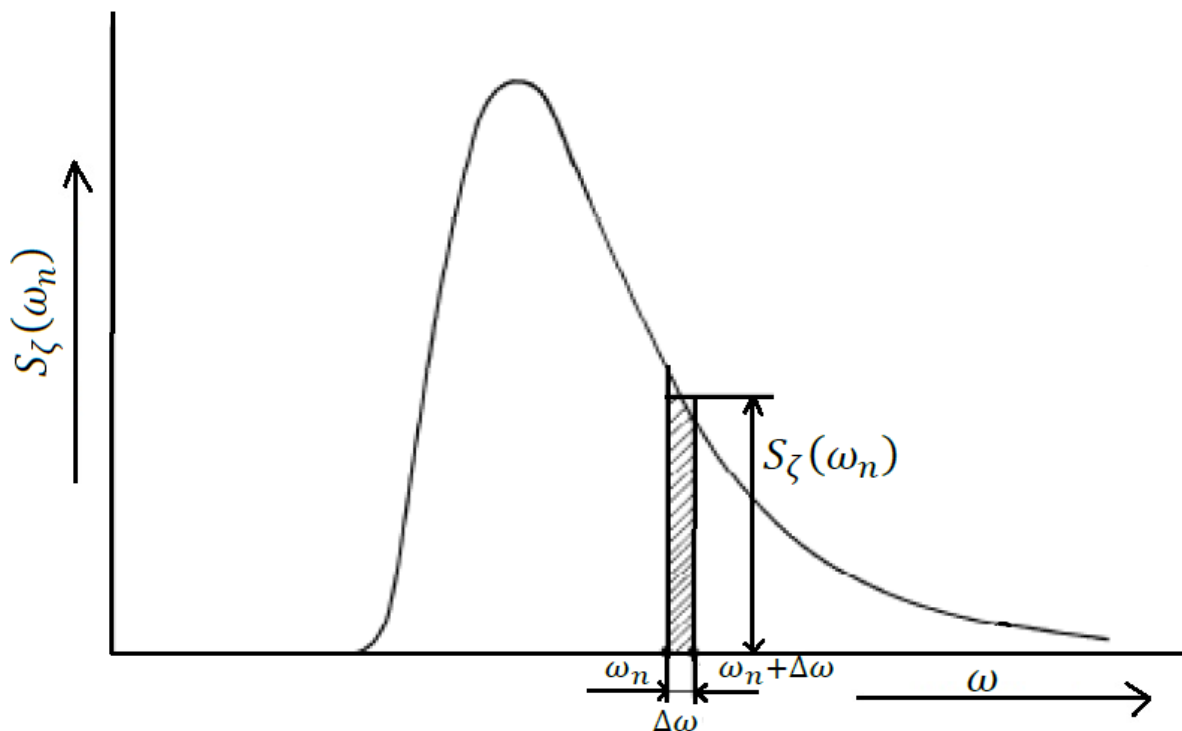

Figure 8.4 – Wave Spectrum

The area under the spectral curve shown in Figure 8.4 gives the total wave energy and is defined by variance given by equation:

$$\sigma^2_{\zeta} = \int_0^{\infty} S_{\zeta}(\omega_n) \cdot d\omega$$

In order to find various parameters like wave amplitude, wave height etc. from the wave spectrum it is important to define another parameter called as moment of the spectrum which is given as:

$$m_{n\zeta} = \int_0^{\infty} \omega^n \cdot S_{\zeta}(\omega_n) \cdot d\omega$$

The relationship between moment and significant wave amplitude is given by equation:

$$\zeta_{a_{1/3}} = 2 \cdot \sqrt{m_{0\zeta}}$$

While the relationship between moment and significant wave height is given by equation:

$$H_{1/3} = 4 \cdot \sqrt{m_{0\zeta}}$$

These equations can be used to find the representative wave parameters which are used in the analysis.

At present a large number of wave spectrums exist and it is important to use correct spectrum for a particular location. Table 8.1 shows the region wise selection of wave spectrum.

Location	Operational	Survival
Norwegian Sea	JONSWAP	JONSWAP
Offshore Brazil	P-M	P-M or JONSWAP
US GoM	P-M	P-M or JONSWAP
West Africa	Ochi - Hubble	Ochi - Hubble

Table 8.1 - Offshore Regions and their Wave Spectrum

A detailed description of these wave spectrums can be found in Appendix B. It must be mentioned here that for the same wave energy the response of FPSO will vary with the spectral model. Hence it is important to use correct spectrum at a particular region. Since in the case study we are using Northern Norwegian Sea conditions so JOSWAP spectrum will be used.

8.2.4 Current

Besides wave and wind loads, the floater units and risers are subjected to current loads. According to DNV currents can be classified into various categories like wind generated current, tidal current, loop current, circulation current and littoral current.

As can be seen from Table 3.1 that current velocity and direction varies with local topographical condition. It also varies with the water depth and in the early years it was believed that no current existed below 1000m. But more research into this field has led to the conclusion that large number of current classes exists at different water depths and current effects can be felt even in water depths up to 2000m.

Some of the effects induced by current which must be taken into account while designing the riser are (DNV, 2010):

- Large FPSO offsets in horizontal plane due to steady current.
- VIV imposed by in line and cross flow current.
- Sea bed scouring near the Touch Down Zone (TDZ) of the riser.

In Orcaflex the current profile taken from the metocean data of the field is inserted which is then used to perform analysis.

8.2.5 FPSO Motions

Due to combined effects of wave, wind and current FPSO is subjected to different kinds of motions as shown in Figure 8.5.

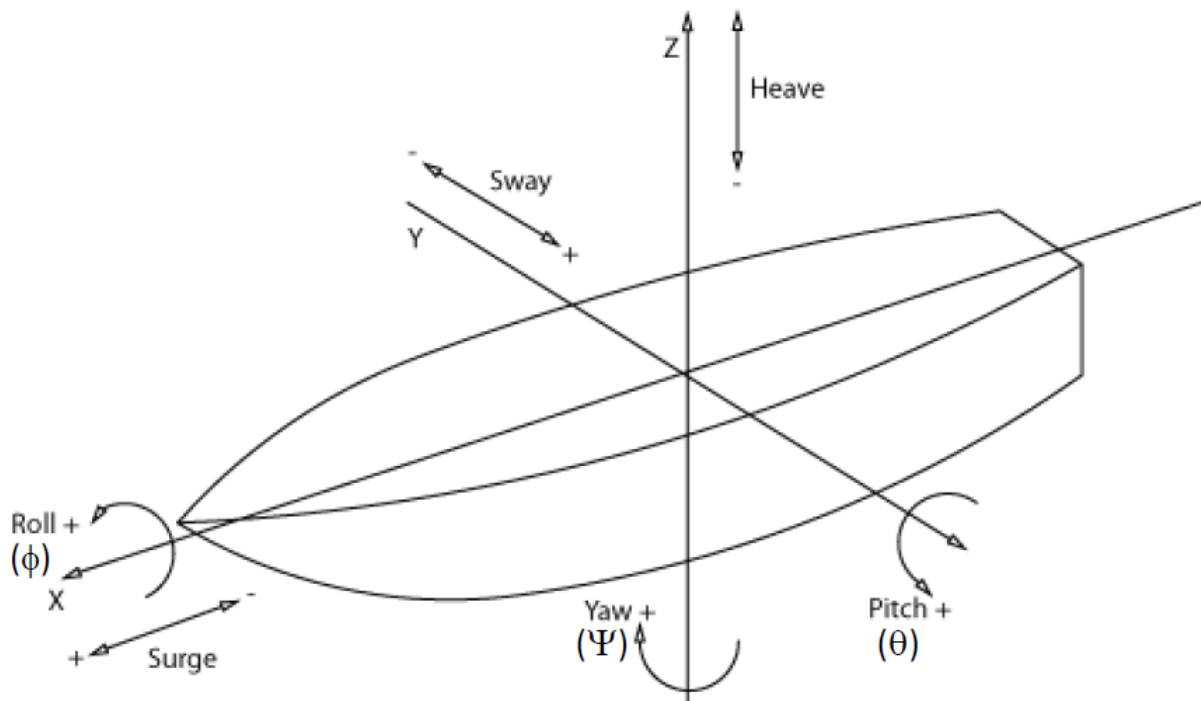

Figure 8.5 – FPSO Motions in Sea [AT-Marine Oy, 2010]

The motion of FPSO can be translational like Surge, Sway and Heave, or it can be rotational like Roll, Pitch and Yaw. In order to understand the relationship between the wave energy spectrum and FPSO motion characteristics we consider a block diagram shown in Figure 8.6.

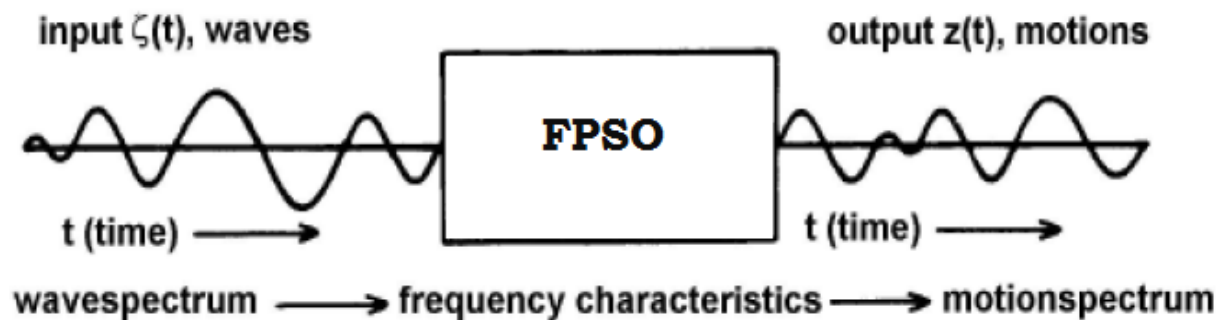

Figure 8.6 – Relationship between FPSO Motions and Waves [Journee and Massie, 2001]

FPSO has its own motion characteristics which are represented by its natural heave, roll and pitch period. An irregular wave represented by the wave energy spectrum provides the

input energy to the FPSO which then depending upon its motion characteristics generates a motion spectrum. As discussed in section 3.3.4 of this thesis, that heave period of FPSO lies in the same spectrum of the sea energy. If the wave period matches with the natural heave period of the FPSO then resonance would occur thereby causing severe FPSO motions and enormous riser response. This high riser response can thus cause high dynamic loads on FPSO and it can even cause fatigue of riser at hang off/ TDP.

FPSO offsets and motions can be another source of static and dynamic loading on the riser. Different types of FPSO offsets that are considered during the riser analysis are [DNV-OS-F201, 2010]:

- **Nominal Offset:** It is mean position of FPSO under the effect of wave, wind and current.
- **Far Offset:** FPSO is displaced away from the riser anchorage point along the plane of the riser and Highest Astronomical Tide (HAT) exists.
- **Near Offset:** FPSO is displaced towards the riser anchorage point along the plane of the riser and Lowest Astronomical Tide (LAT) exists.
- **Cross Offset:** FPSO is displaced in plane lateral to the riser anchorage point.

Similarly two types of FPSO motions occur due to wave loads on the FPSO. These are [DNV-OS-F201, 2010]:

- **Wave Frequency (WF) Motions:** The FPSO motions at periods from 3-25 seconds which are result of first order wave loads on the FPSO.
- **Low Frequency (LF) Motions:** The FPSO motions at periods from 30-300 seconds which are result of second order wave loads on the FPSO.

Amongst both of these motions, Wave Frequency motions of FPSO are given as RAO which is discussed next.

8.2.6 Response Amplitude Operator (RAO)

RAO is a transfer function which relates the vessel motion response to the wave energy spectrum. For an FPSO or other floater unit the vessel motions in all six degrees of freedom have separate RAOs which must be fed in the analysis software to generate accurate vessel response. The RAOs of the FPSO used in the case study are treated as confidential and hence not discussed further.

8.2.7 Hydrodynamic Coefficients

Generally two types of hydrodynamic coefficients namely drag coefficient (C_D) and added mass coefficient (C_A) are used to calculate the force due to waves and currents on the riser. These coefficients depend upon number of factors like [DNV-RP-C205, 2010]:

- Body shape;
- Reynolds number ($Re = UD/\nu$), where U is the free stream velocity, D is the diameter of object considered, and ν is the kinematic viscosity;
- Keulegan Carpenter number $KC = U_M T/D$, where U_M is the free stream velocity amplitude of the oscillatory flow, and T is the period of oscillation;
- Roughness ratio k/D , where k is the characteristic dimension of the roughness on the body;
- Reduced velocity $U/f_n D$, where f_n is the natural frequency of the riser
- Relative current number U_c/U_M , where U_c is the current velocity

Since riser has a cylindrical shape so value of drag coefficients can be taken from Figure 8.7 adapted from DNV-RP-C205, 2010. The value of k used in Figure 8.7 can be taken from Table 8.2.

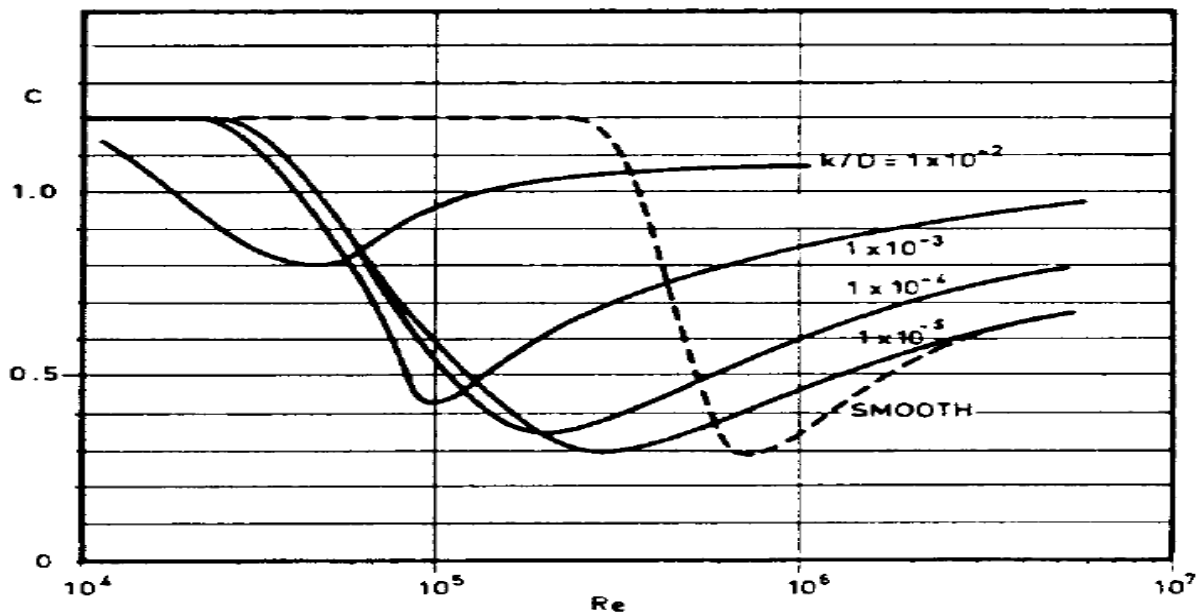

Figure 8.7 – Drag Coefficients for Fixed Circular Cylinder for Steady Flow [DNV-RP-C205, 2010]

Material	k (m)
Steel, new uncoated	5×10^{-5}
Steel, painted	5×10^{-6}
Steel, highly corroded	3×10^{-3}
Concrete	3×10^{-3}
Marine growth	5×10^{-3} to 5×10^{-2}

Table 8.2 – Surface Roughness [DNV-RP-C205, 2010]

Added mass coefficient can be taken from Figure 8.8 adapted from DNV-RP-C205, 2010.

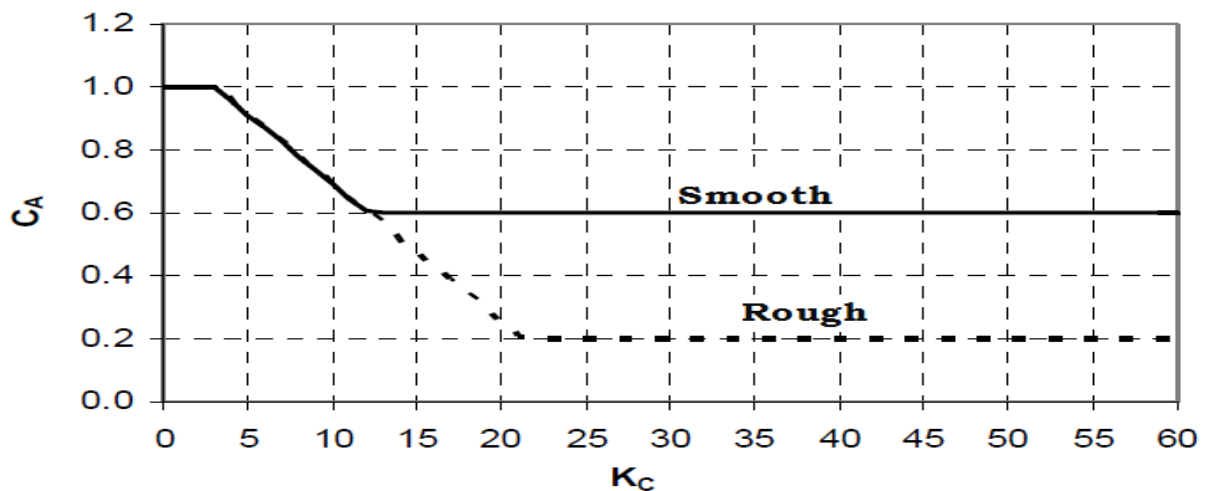

Figure 8.8 – Added Mass Coefficient as Function of K_c Number for Cylinder [DNV-RP-C205, 2010]

All these coefficients are inserted in the analysis software which then uses Morison equation to compute the drag and inertia forces on the riser.

8.2.8 Global Analysis

The purpose of doing global analysis is to capture the response of the riser system under the effect of different kinds of loads. According to DNV the parameters which are important from the global analysis point of view are:

- Cross-Section forces like effective tension, bending moment etc.
- Global riser deflections like normalized curvature, angular rotation etc.
- Global riser position like coordinates offsets etc.

Two principal global analysis activities for SLWR and lazy wave flexible riser are [DNV-OS-F201, 2010]:

- 1. Extreme Analysis:** It is performed to ensure that the stresses in riser are within allowable limits even for extreme loads. It consists of static and dynamic analysis.
- 2. Fatigue Analysis:** It is performed to ensure that riser has capability to sustain fatigue damage and it will not fail due to fatigue during its service life.

For this case study global riser analysis is performed on Orcaflex and mainly three types of analysis namely static, dynamic and fatigue is done.

8.2.8.1 Static Analysis: This is the first step of global riser analysis and it forms the basis of dynamic analysis. The main aim of static analysis is to determine the suitable static riser configuration under various static loads like gravity, buoyancy, internal fluid, vessel offsets and current. According to DNV the four rudimentary static loading components are:

- 1. Volume Forces:** To derive static equilibrium we consider the Figure 8.9 which depicts a small segment of curved riser which is under the combined influence of tensile load, external hydrostatic pressure and internal fluid pressure.

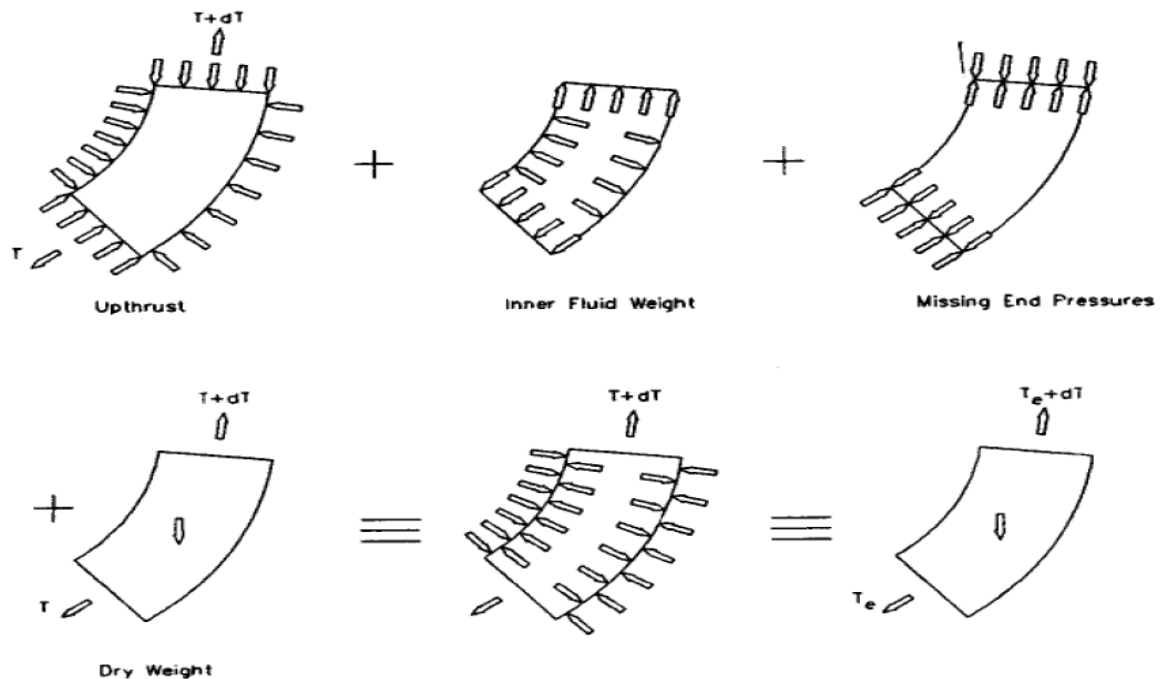

Figure 8.9 – Effective Weight and Tension [Bartrop, 1998]

Figure 8.9 can be used to derive formula for effective weight and effective tension which are given as:

$$\text{Effective Weight} = W_{\text{eff}} = \gamma_s * A_s + \gamma_i * A_i - \gamma_o * A_o$$

$$\text{Effective Tension} = T_{\text{eff}} = T_i + P_o * A_o - P_i * A_i - \rho_i * U_i * U_i * A_i$$

Where:

γ = Weight Density; i = subscript for “inner”
 A = Area; o = subscript for “outer”
 P = Pressure; s = subscript for “structural”
 T = Tension; t = subscript for “true”
 ρ = Mass Density U = Flow Velocity

2. Specified Forces: In order to prevent compression of the riser during installation and operation phase, specific amount of top tension has to be applied on the riser. This tension should also be taken into account while doing static analysis.

3. Prescribed Displacement: Static analysis should also be performed for specified position of the riser depending upon the operation. For example pull in analysis covering riser installation on the FPSO from the sea bed may be performed in order to calculate the static forces on the riser during this process.

4. Displacement Dependent Forces: An example of this force is a current load on the riser which induces drag force on the riser and thus increases the effective tension. This must also be accounted in the static analysis once the top angle has been set.

8.2.8.2 Dynamic Analysis: The next step of the global analysis is to perform dynamic analyses of the riser system. The main aim of doing dynamic analysis is to estimate the extreme response of the riser system during its service life under the combined effects of environmental loads.

In this phase, the effect of vessel motions (taken from RAO) is combined with wave and current forces to calculate hydrodynamic forces to obtain the response of the riser. The sea state can be presented by regular wave or irregular wave and the two most common methods of performing this analysis are frequency domain analysis and time domain analysis whose application area are presented in Table 8.3.

Method of Analysis	Typical Application
Frequency Domain	Screening analysis Fatigue Limit State analysis of systems with small/moderate nonlinearities.
Linear Time Domain	Extreme analysis of systems with small/moderate structural nonlinearities and significantly nonlinear hydrodynamic loading.
Nonlinear Time Domain	Extreme response analysis of systems with significant nonlinearities, in particular compliant configurations exposed to 3D excitation. Special Fatigue Limit State analyses for systems or parts of systems with highly nonlinear response characteristics (e.g. touch-down area of compliant configurations)

Table 8.3 – Typical Analysis Technique and its Application [DNV-OS-F201, 2010]

8.2.9 Time Domain Fatigue Analysis

It involves calculating fatigue damage due to WF, LF and VIV. The calculation of fatigue damage due to first two contributors employ the following procedure:

- Divide the wave scatter diagram into representative blocks.
- From each block a representative sea state is selected and nonlinear time domain analysis is performed for this sea state.
- Once nonlinear time domain analysis is finished for all the blocks, use rain flow counting method to calculate the fatigue damage for a particular direction of wave. It is during this stage that the total exposure time of the particular wave direction is fed into the software which takes account of the fatigue probability of the wave direction.
- Add fatigue damage of all the blocks in order to get total fatigue damage for that particular direction.
- Perform the same procedure for all the wave direction.
- The predicted fatigue life is reciprocal of the cumulative fatigue damage.

The VIV fatigue analysis is not being considered in this case study due to limitation of time however it will be discussed theoretically in the relevant section. Henceforth the discussion will be for fatigue damage due to WF and LF.

According to DNV, S-N data forms the basis of the fatigue analysis. The S-N curve depicts the fatigue capacity of structure, where S represents the constant stress range while N represents the number of cycles to failure. The general expression is expressed as:

$$\log(N) = \log(a) - m \cdot \log(S);$$

where “a” and “m” are empirically derived and are properties of the material. The stress range applied to calculate the fatigue damage is given as:

$$S = S_0 * SCF * \left(\frac{t}{t_{ref}}\right)^k$$

Where:

S_0 = Nominal Stress Range

SCF = Stress Concentration Factor = Hot Spot Stress Range/ Nominal Stress Range.

$(t/t_{ref})^k$ = thickness correction factor, which applies to pipe whose wall thickness “t” is greater than $t_{ref} = 25\text{mm}$.

k = thickness exponent on fatigue strength.

Selecting a right S-N curve is must while performing the fatigue analysis. Some of the factors which influence the selection of S-N curve are (DNV, 2010):

- Geometry of the detail.
- Relative direction between varying stress and the detail.
- Fabrication and inspection method of the detail.

Generally sea water S-N curve with cathodic protection which is a bilinear curve is used for riser fatigue damage due WF and LF floater motions. Figure 8.10 shows the S-N curve for sea water and cathodic protection.

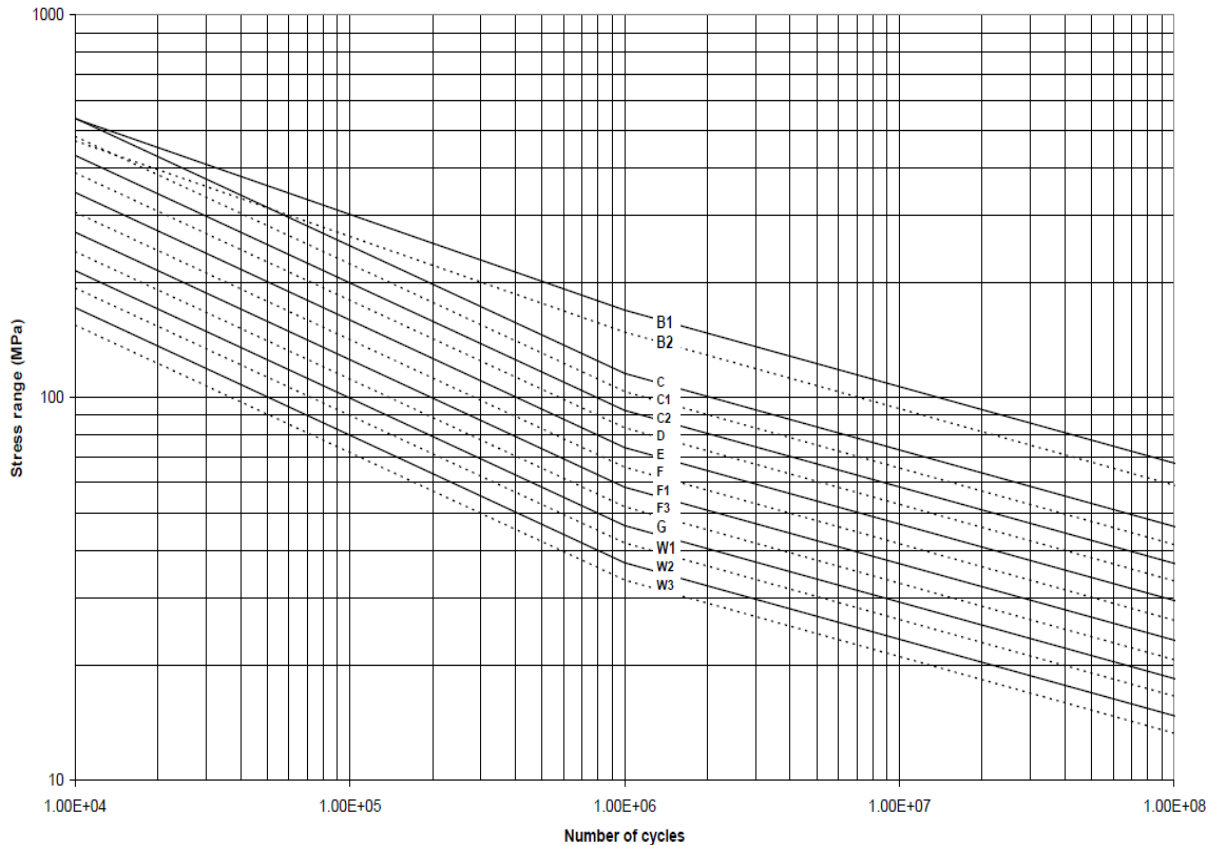

Figure 8.10 – S-N Curves in Seawater with Cathodic Protection [DNV-RP-C203, 2010]

Once number of stress cycles is decided the next step is to find the cumulative fatigue damage using Miner's rule which can be written as:

$$D = \sum_i \frac{n(S_i)}{N(S_i)}$$

Where:

D = accumulated fatigue damage

n (Si) = number of stress cycles with range Si

N (Si) = number of cycles to failure at constant stress range Si

8.3 System Overview

A lazy wave configuration involves the usage of discrete buoyancy modules along the particular section of riser length to modify its free hanging configuration. The system under consideration consists of a lazy wave flexible/steel riser connected to an internal turret moored FPSO. For both risers same configuration as shown in Figure 8.11 is used. The riser lengths are approximately the same and the only major difference is in the length of buoyancy section and the pitch of buoyancy modules for the two configurations.

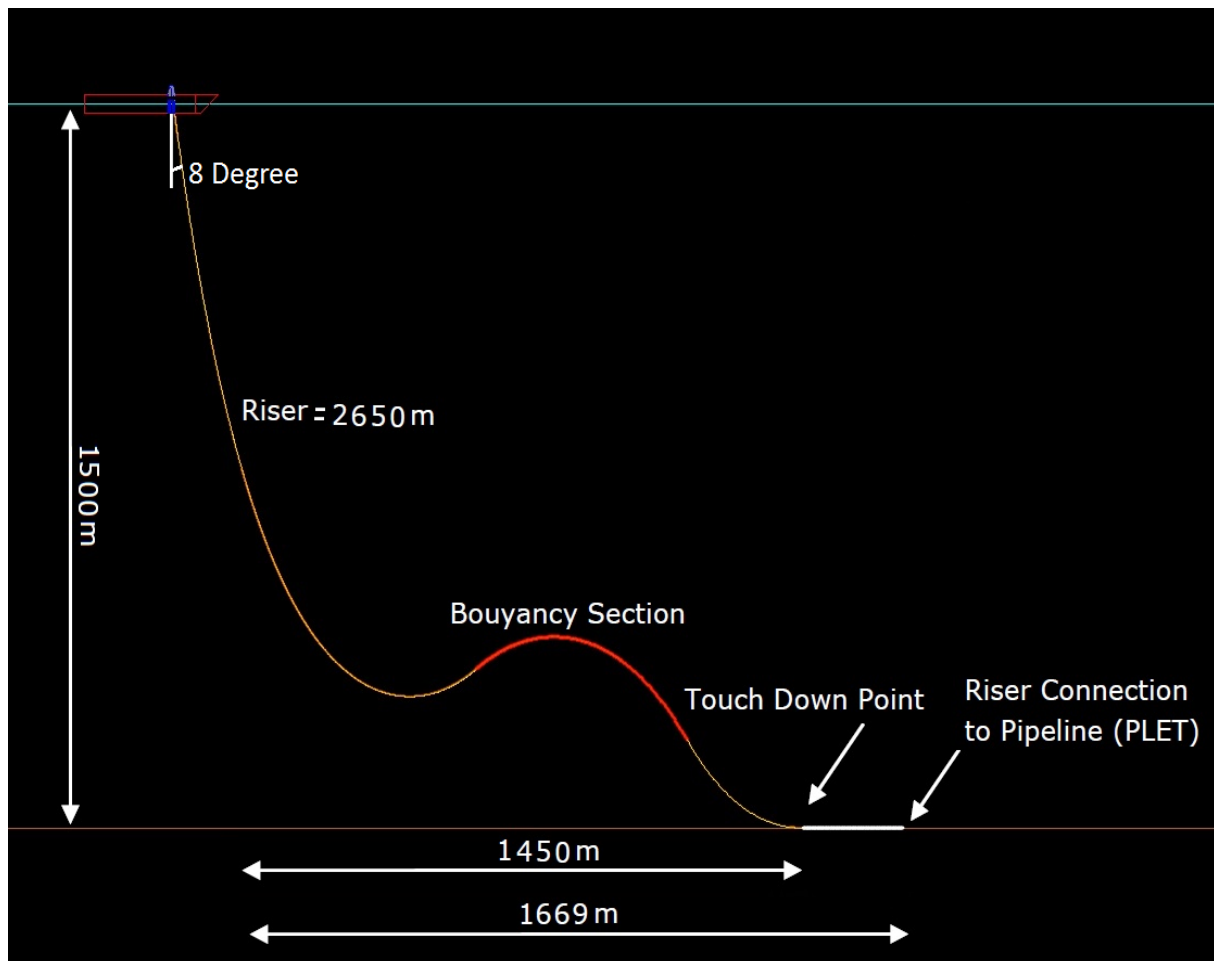

Figure 8.11 – Lazy Wave Riser Configuration Used in Case Study

8.4 Environmental Condition

Location

The FPSO is assumed to be stationed at 1500 deep water in harsh environmental condition of Northern North Sea. The sea water density is 1025kg/m³.

Waves

The wave data for a typical Northern Norwegian Sea location is considered. The wave data is shown in Table 8.4.

	100 Year Return Period
Significant Wave Height, H _s (m)	17
Corresponding Wave Peak Period, T _p (s)	18.8
Wave Spectrum	JONSWAP
Wave Load Modelling	Irregular Wave

Table 8.4 – Wave Data [Karunakaran & Baarholm, 2013]

Current

The current flow direction is assumed to be in the same direction as the vessel offset as the extreme vessel offset is governed by wave, wind and current [Karunakaran & Baarholm, 2013]. Current profile for 10 year return period is presented in Table 8.5.

Water Depth (m)	10 - Year Current (m/s)
At Surface	1.65
-50	1.26
-100	1.25
-200	1.09
-300	0.83
-400	0.74
-500	0.73
-600	0.6
-800	0.6
-1000	0.55
-1200	0.55
-1497	0.46

Table 8.5 – Current Data [Karunakaran & Baarholm, 2013]

Hydrodynamic Coefficient

Generally two types of hydrodynamic coefficients namely drag coefficient (C_D) and added mass coefficient (C_A) are used to calculate the force due to waves and currents on the riser. These coefficients depend upon number of factors like Reynolds Number (Re), Keulegan Carpenter Number (KC), surface roughness, shape of the structure etc. The hydrodynamic coefficients used for the study are shown in Table 8.6.

Parameter	Coefficient
Drag Coefficient (C_D)	1.1
Added Mass Coefficient (C_A)	1

Table 8.6 – Hydrodynamic Coefficients [Karunakaran & Baarholm, 2013]

Soil-Riser Interaction

Due to oscillatory motion of the riser it penetrates in the seabed which increases the resistance from soil on it. Hence this complex interaction of riser TDP and seabed is modeled by linear soil stiffness and friction [Karunakaran and Baarholm, 2013]. The soil properties used in the study are shown in Table 8.7.

Lateral Friction Coefficient	0.5
Axial Friction Coefficient	0.3
Horizontal Lateral/Axial Soil Stiffness	200kN/m ²
Vertical Soil Stiffness	50kN/m ²

Table 8.7 – Soil Properties [Karunakaran & Baarholm, 2013]

8.5 Vessel Data

A typical turret moored FPSO with corresponding RAO data is used in the study. The vessel RAO used are confidential hence not shown in thesis while the vessel offsets used for strength analysis are shown in Table 8.8.

Type of Analysis	Case	Vessel Offset
Static	Operational Condition-Intact Mooring	10% of Water Depth = 150m
Static	Accidental Condition-One Mooring Line Failure	12% of Water Depth = 180m
Dynamic	Operational Condition-Intact Mooring	10% of Water Depth = 150m
Dynamic	Accidental Condition-One Mooring Line Failure	12% of Water Depth = 180m

Table 8.8 – Vessel Offset Data

8.6 Riser Properties

Since two different types of risers will be analyzed in the study so their data is presented separately.

Steel Riser Properties

The minimum wall thickness of the riser is estimated based on burst, collapse and combined loading criteria given in DNV-OS-F201 and DNV-OS-F101. The properties of steel riser used in the analyses are presented in Table 8.9.

Parameter	Design Value	Unit
Internal Diameter	254	mm
Wall Thickness	26	mm
Grade	API5L, X65 SMLS	
Young's Modulus	207	GPa
SMYS	448	MPa
Poisson Ratio	0.3	
Steel Density	7850	kg/m ³
Design Life	25	Years
Design Pressure	500	Bar
Content Density	500	kg/m ³
Thickness of Coating	76.2	mm
Density of Coating	700	Kg/m ³
Safety Class	High	
Corrosion Allowance	3	mm

Table 8.9 – Steel Riser Properties [Karunakaran & Baarholm, 2013]

Also it must be noted that for extreme loading, the flex-joint stiffness will not affect the response of the riser [Karunakaran and Baarholm, 2013]. Hence the riser end connected to FPSO turret has been modeled as pinned in Orcaflex which signifies that no bending moment is present at this point.

Since for lazy wave configuration buoyancy modules will be required so their properties are shown in Table 8.10.

Parameter	Value	Unit
Module Outer Diameter	1700	mm
Module Length	1700	mm
Module Volume	3.578	m ³
Module Mass	1456	kg
Module Displacement	3668	kg
Module Net Buoyancy	- 2211	kg
Pitch	12	m
Buoyancy Length	570	m
Material Density	400	kg/m ³

Table 8.10 – Properties of Buoyancy Module for SLWR

Flexible Riser Properties

The properties of flexible riser, end fitting, bend stiffener and buoyancy module are listed in Table 8.11, Table 8.12, Table 8.13 and Table 8.14 respectively.

Parameter	Design Value	Unit
Internal Diameter	254	mm
Outer Diameter	400	mm
Design Life	25	Years
Minimum Bending Radius	4	m
Allowable Tension	2700	kN
Axial Stiffness	550	MN
Bending Stiffness	150	kNm ²
Torsional Stiffness	90	kNm ²
Weight in Air, Empty	250	kg/m
Submerged Weight, Empty	118	kg/m
Content Density	500	kg/m ³

Table 8.11 – Flexible Riser Properties

Parameter	Value	Unit
Inner Diameter	254	mm
Outer Diameter	466	mm
Contact and Drag Diameter	600	mm
Section Length	2000	mm
Mass per Unit Length	947	kg/m

Table 8.12 – End Fitting Properties

Parameter	Value	Unit
Outer Diameter, Thick End	1000	mm
Section Length	6000	mm
Mass per Unit Length	600	kg/m

Table 8.13 – Bend Stiffener Properties

Parameter	Value	Unit
Module Outer Diameter	1240	mm
Module Length	1240	mm
Module Volume	1.342	m ³
Module Mass	562	kg
Module Displacement	1375	kg
Module Net Buoyancy	- 813	kg
Pitch	3	m
Buoyancy Length	590	m
Material Density	400	kg/m ³

Table 8.14 – Properties of Buoyancy Module for Lazy Wave Flexible Riser

8.7 Static Analysis

The main aim of this stage of analysis is to determine the suitable static riser configuration under various static loads like gravity, buoyancy, internal fluid, vessel offsets and current. A load case matrix as shown in Table 8.15 is prepared which takes into account various combinations of possible static loads.

Load Case	Vessel Offset	Condition	Wave and Current Return Period
1	Nominal	Operational Condition - Intact Mooring, Vessel Offset is 10% of Water Depth	100 Year Wave + 10 Year Current
2	Far (+150m)		
3	Near (-150m)		
4	Far (+180m)	Accidental Condition - One Mooring Line Failure, Vessel Offset is 12% of Water Depth	
5	Near (-180m)		

Table 8.15 – Load Cases

For this thesis static analysis will be carried separately for the two riser concepts. The results which are interesting from static point of view are riser configuration, top angle and effective tension at critical locations of riser.

8.7.1 Steel Lazy Wave Riser

The main results of static analysis for SLWR are riser configuration in various offset position, effective tension and bending moment along the length of riser. Results for load case 1 are presented below in the form of figures and tables while detailed result are in Appendix C.

1. Static Riser Configuration

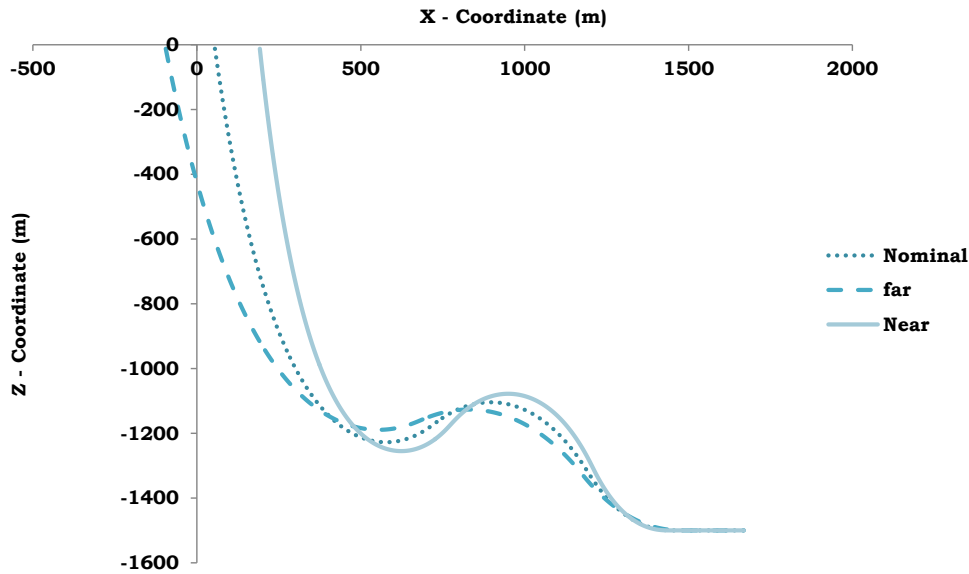

Figure 8.12 – SLWR Riser Configuration for Static Analysis

Figure 8.12 depicts that vessel offset changes the riser configuration tremendously. When the vessel is in far position then the radius at sag, hog and TDP is reduced and tension is increased in the riser however the inverse happens for near position of vessel. It must be pointed here that as the water depth increases the offset also increases as for extreme environment it is 10% (ULS) of water depth thereby changing the riser configuration.

2. Static Effective Tension

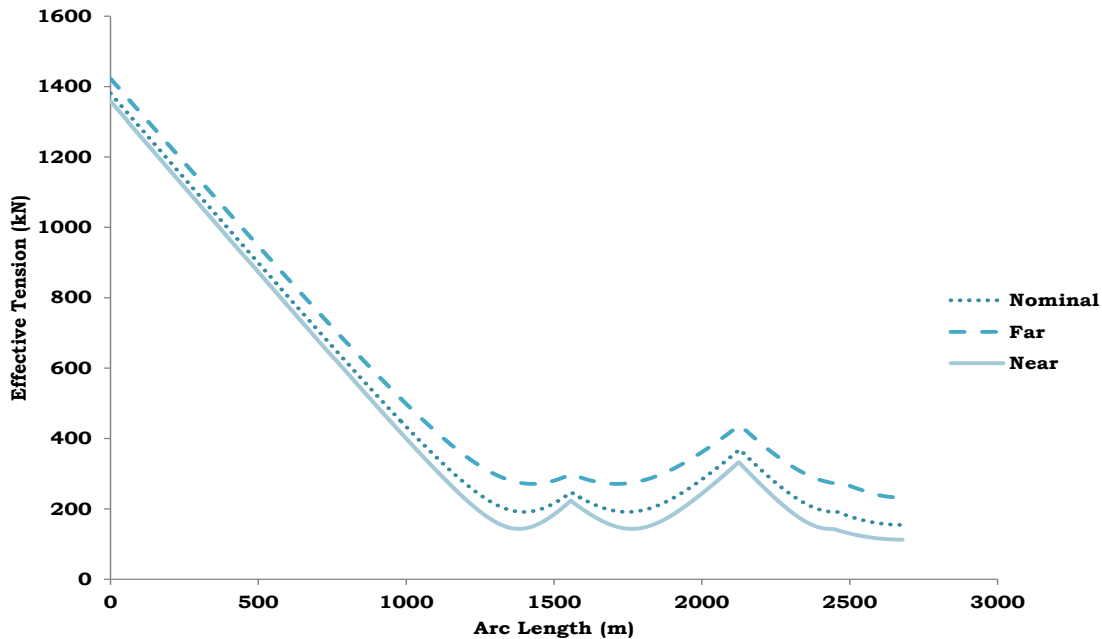

Figure 8.13 – SLWR Effective Tension for Static Analysis

Figure 8.13 shows the static effective tension for SLWR which is a function of the suspended riser length. Hence as the arc length increases the effective tension in the riser also

increases. It is important to note that for all the FPSO offset positions the value of effective tension is positive which indicates that no buckling (as an Euler strut) occurs in the riser.

For the far position the radius at sag and hog bend is reduced which indicates high tension in the riser however for near position these radii are reduced which indicate less static effective tension.

Static Bending Moment

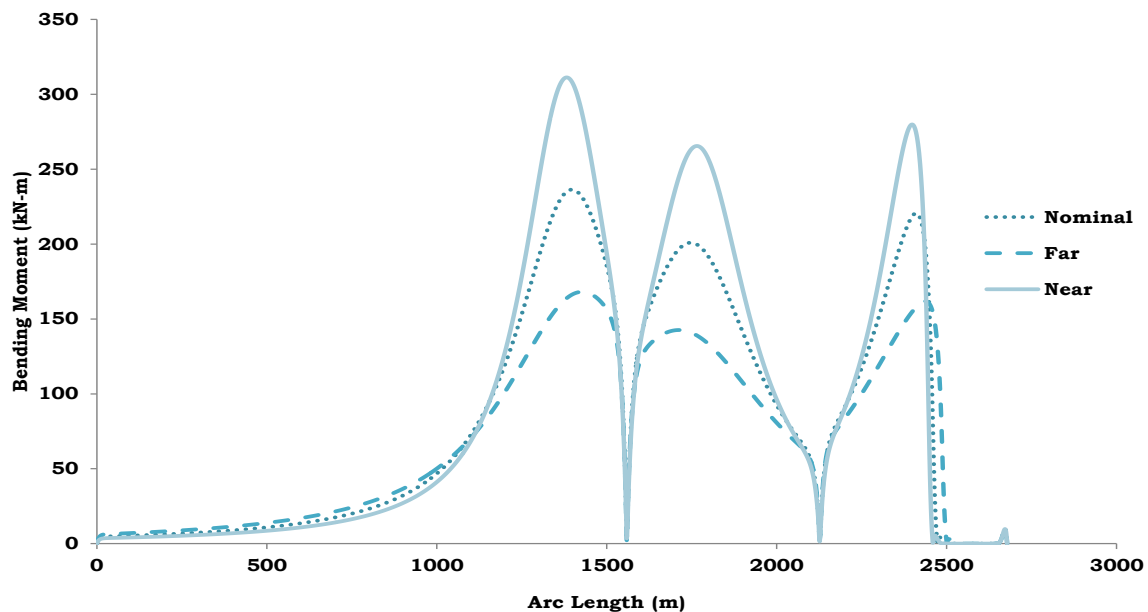

Figure 8.14 – SLWR Bending Moment for Static Analysis

The formula of Bending Moment $M = (E \cdot I) / R$, where E is Young's Modulus, I is 2nd moment of inertia and R is radius of curvature. So from this formula it can be seen that bending moment is inversely proportional to the radius of curvature. In near load case, the distance from FPSO to riser anchorage point is closest which results in smallest radii at sag bend, hog bend, TDP and hence highest static bending moment at these locations when compared to near and far offset position as shown in Figure 8.14.

3. Summary

Table 8.16 shows the summary of results for static analysis of SLWR.

	Ultimate Limit State			Accidental Limit State	
	Near	Nominal	Far	Near	Far
Top Angle (deg)	6	8	11	5.7	11.8
Max: Top Tension (kN)	1360	1380.6	1422.6	1356.5	1435.4
Tension at TDP (kN)	143	191	270	134.6	292.5

Table 8.16 – SLWR Static Analysis Result

Result Discussion: As expected the maximum top tension, TDP tension, top angle occurs for far FPSO offset in case one mooring line fails (ALS). This is because FPSO is at farthest distance from the riser anchorage point and this increases tensile force on the entire riser segment leading to increase in top tension and TDP tension. Also the riser has positive value of tensions for all vessel offset position which indicates that no buckling occurs in the riser.

8.7.2 Lazy Wave Flexible Riser

The main results of static analysis for lazy wave flexible riser are riser configuration in various offset position, effective tension and normalized curvature along the length of riser. Results for load case 1 are presented below in the form of figures and tables while detailed result are in Appendix C.

1. Static Riser Configuration

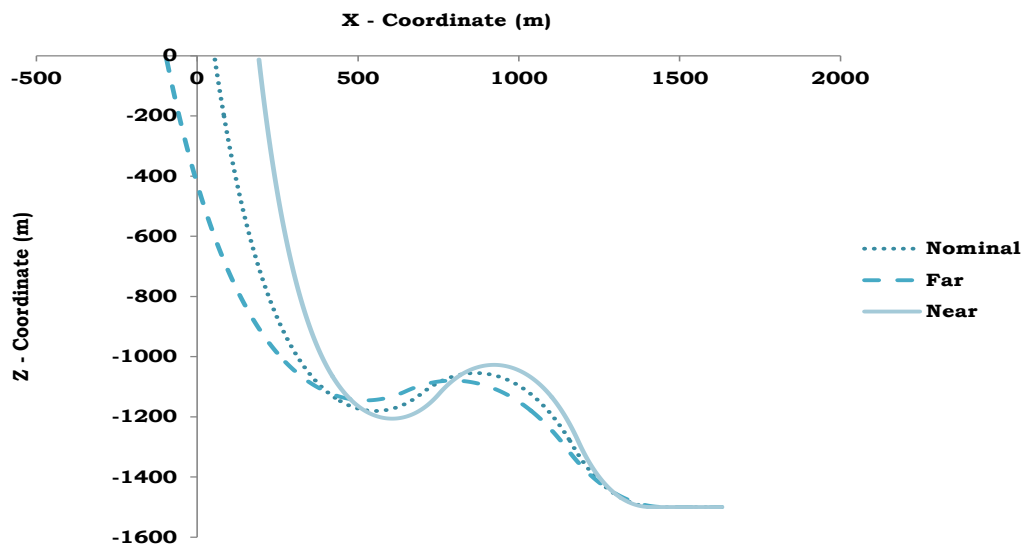

Figure 8.15 – Lazy Wave Flexible Riser Configuration for Static Analysis

It is clearly visible from Figure 8.15 that FPSO excursion has tremendous effect on the riser configuration. Also it is to be emphasized that as the water depth increases the FPSO offset would increase proportionally hence causing more tension in the riser and also reducing the bending radius at sag bend, hog bend and TDP.

2. Static Effective Tension

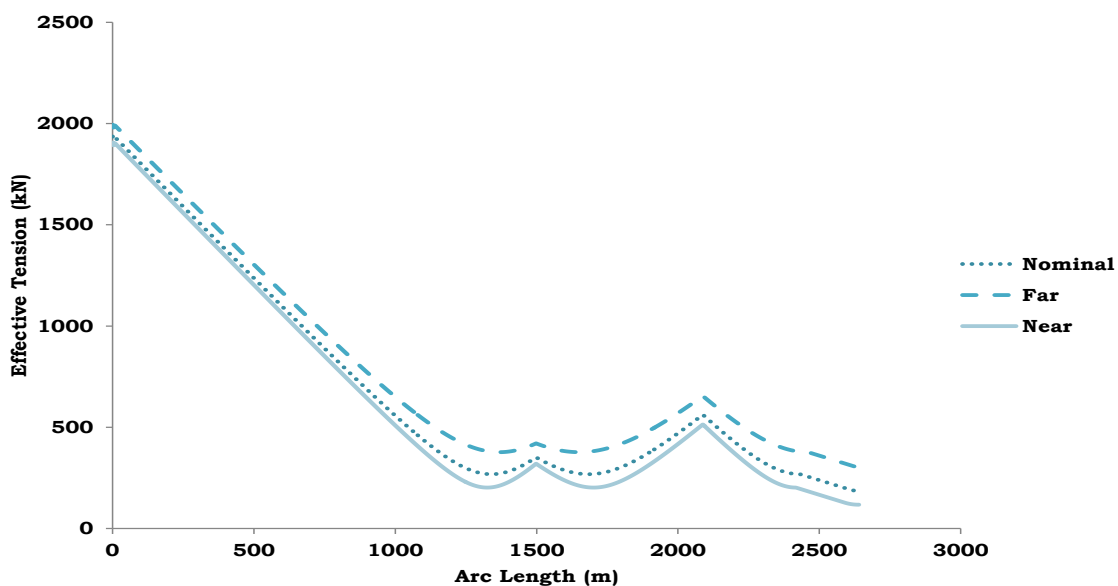

Figure 8.16 – Lazy Wave Flexible Riser Effective Tension for Static Analysis

Static effective tension force is a function of suspended riser length. For far vessel offset highest static tension occurs due to its longest suspended length compared to mean and near case.

3. Static Normalized Curvature

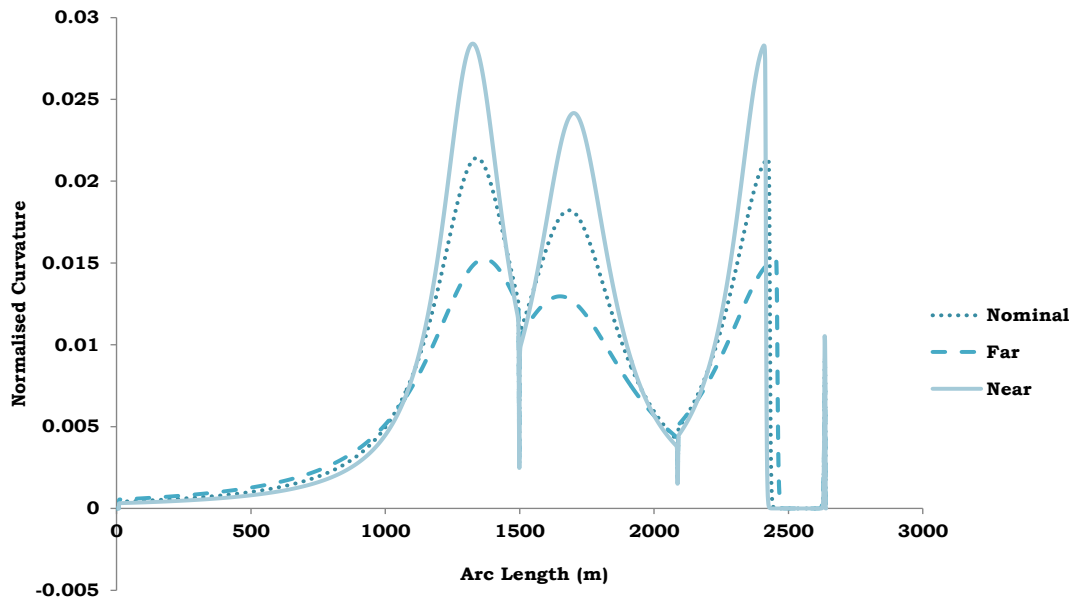

Figure 8.17 – Lazy Wave Flexible Riser Normalized Curvature for Static Analysis

Normalized curvature is defined as curvature divided by allowable curvature. It can be seen from Figure 8.17 that it is way below 1 hence depicting that the bending radii of riser is greater than MBR of 4m for the riser throughout its length.

4. Summary

Table 8.17 shows the summary of results for static analysis of free hanging flexible riser.

	Operational Condition			Accidental Condition	
	Near	Nominal	Far	Near	Far
Top Angle (deg)	6.1	8	11	5.8	11.6
Maximum Top Tension (kN)	1907	1936.3	1994	1902	2012
TDP Tension (kN)	201	268.2	376.8	190	405.8
Minimum Radius (m)	141	187	263	132	283

Table 8.17 – Lazy Wave Flexible Riser Static Analysis Result

Result Discussion: As expected the maximum top tension, TDP tension and top angle occurs for far FPSO offset in case one mooring line fails (ALS). This is because FPSO is at farthest distance from the riser anchorage point and this increases tensile force on the entire riser segment leading to increase in top tension and TDP tension.

The minimum radius of the riser configuration occurs for near FPSO offset in case one mooring line fails. This is expected as FPSO is nearest to the riser anchorage point which tends to reduce the radii at sag bend, hog bend and TDP. Also the minimum radius for all vessel offsets is greater than MBR of 4m for the riser, which is a must requirement for flexible risers.

8.8 Dynamic Analysis

The next step of the global analysis is to perform dynamic analyses of the riser system. The main aim of doing dynamic analysis is to estimate the extreme response of the riser system during its service life under the combined effects of environmental loads, and functional loads. The load cases used for static analysis are used for dynamic analysis as well.

For dynamic analyses irregular wave is considered. Three-hour design storm duration is considered, the wave profile for which is shown in Figure 8.18.

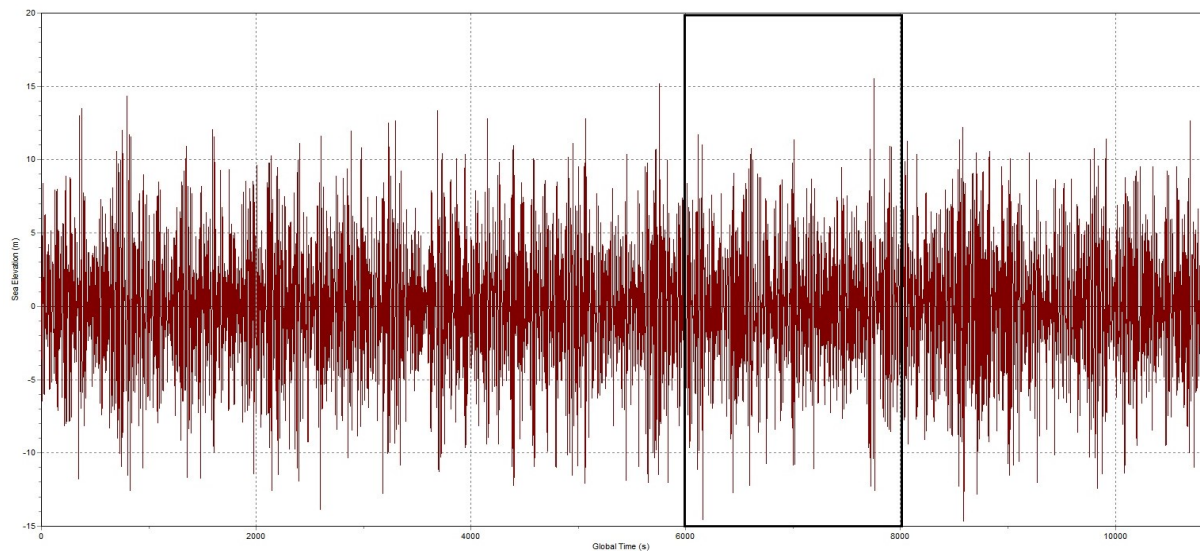

Figure 8.18 – Wave Profile for 3 Hours

The dynamic analyses are run in a 2000s time frame, from 6000s to 8000s (black box) as both the crest and trough extremes occur in this time interval.

8.8.1 Steel Lazy Wave Riser

The results for SLWR are presented in table and graphical form. The graph for load case 1 is presented below while for rest load cases results are presented in Appendix C.

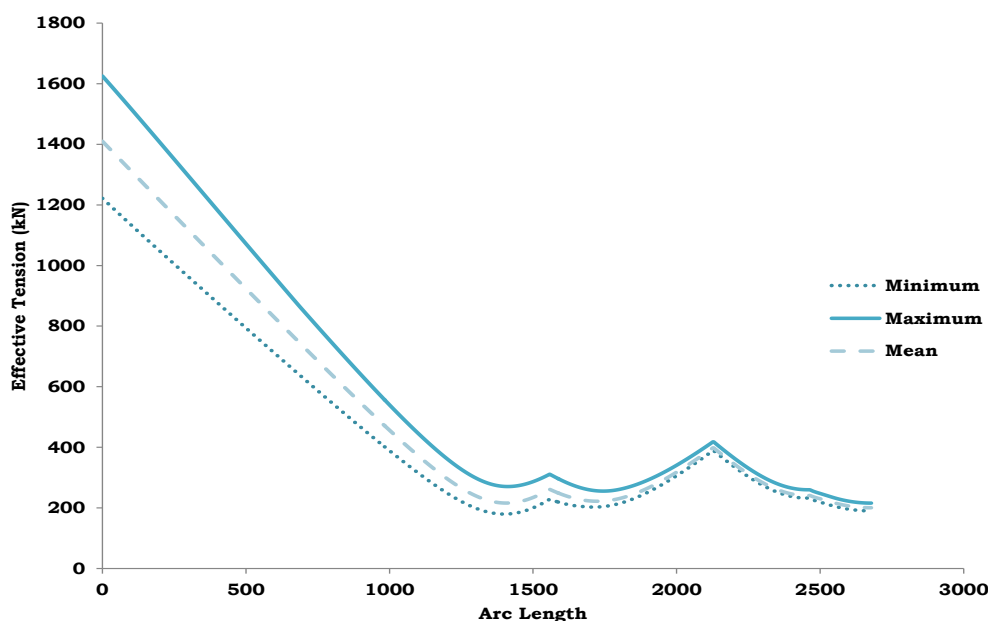

Figure 8.19 – SLWR Effective Tension for Dynamic Analysis

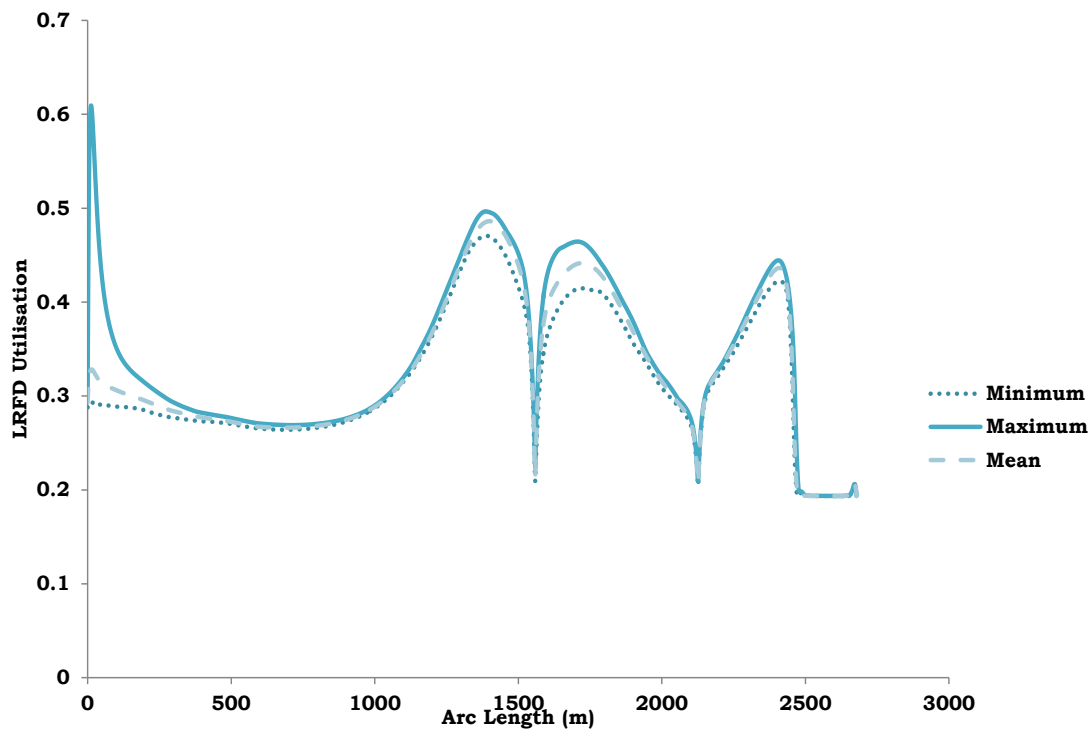

Figure 8.20 – SLWR LRF D Utilization for Dynamic Analysis

	Ultimate Limit State			Accidental Limit State	
	Near	Nominal	Far	Near	Far
Max: Top Tension (kN)	1587	1621	1667	1534	1688
Min: Tension (kN)	70	181	248	66	266
Max: LRF D Stress Utilization	0.71	0.61	0.55	0.69	0.48

Table 8.18 – SLWR Dynamic Analysis Result

Result Discussion: Maximum tension in the riser occurs for far FPSO offset in case of one mooring line failure (ALS). This is due to same reasoning given under static analyses result discussion. Also since the minimum tension is positive, so this indicates that riser is not subjected to compression and hence no buckling occurs in the riser.

When we employ LRF D format to calculate stress utilization then we are segregating functional loads from environmental loads. This is done by using different load factors for functional loads and environmental loads. It can be seen from Table 8.18 that the value of LRF D stress utilization for ALS condition is less than ULS condition. This is because the value of functional and environmental load factors for ALS condition is 1, while the value of same factors for ULS condition is 1.1 and 1.3 respectively. The lower value of loads factors for ALS condition lowers the value of LRF D stress utilization.

The maximum stress utilization occurs for near offset position when all the mooring lines are intact (ULS). This maximum stress utilization is lower than 1 which indicates that maximum stress in the riser is lower than SMYS and hence design is safe.

8.8.2 Lazy Wave Flexible Riser

The results for lazy wave flexible riser are presented in table and graphical form. The graph for load case 1 is presented below while for rest load cases results are presented in Appendix C.

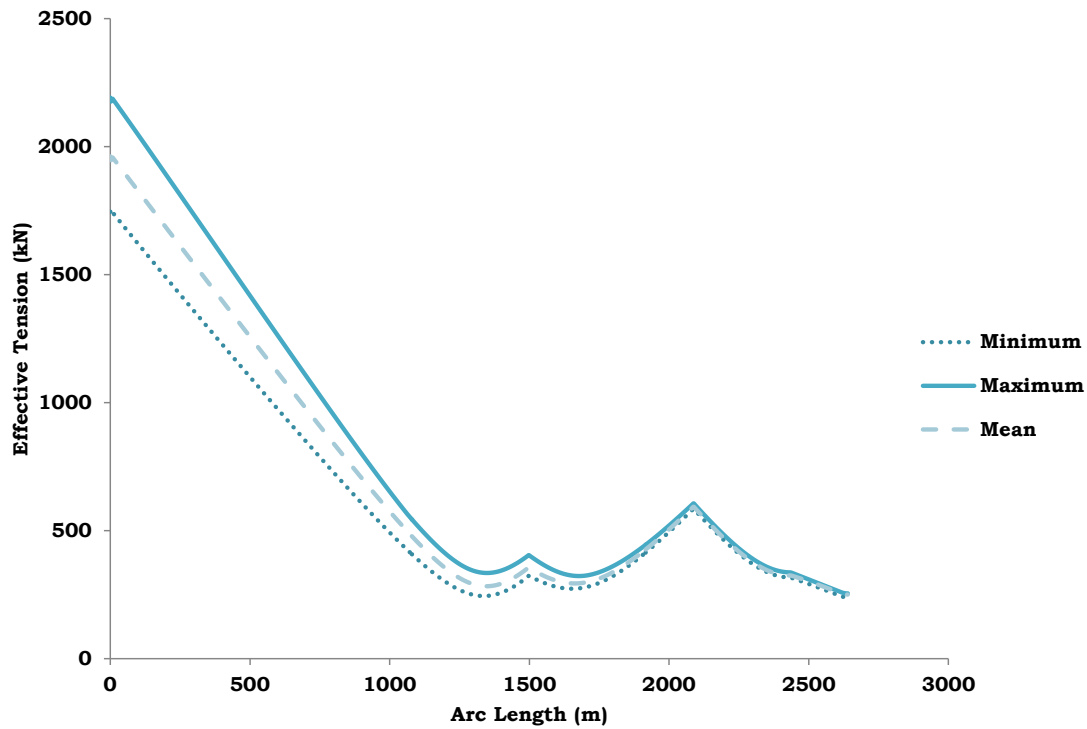

Figure 8.21 – Lazy Wave Flexible Riser Effective Tension for Dynamic Analysis

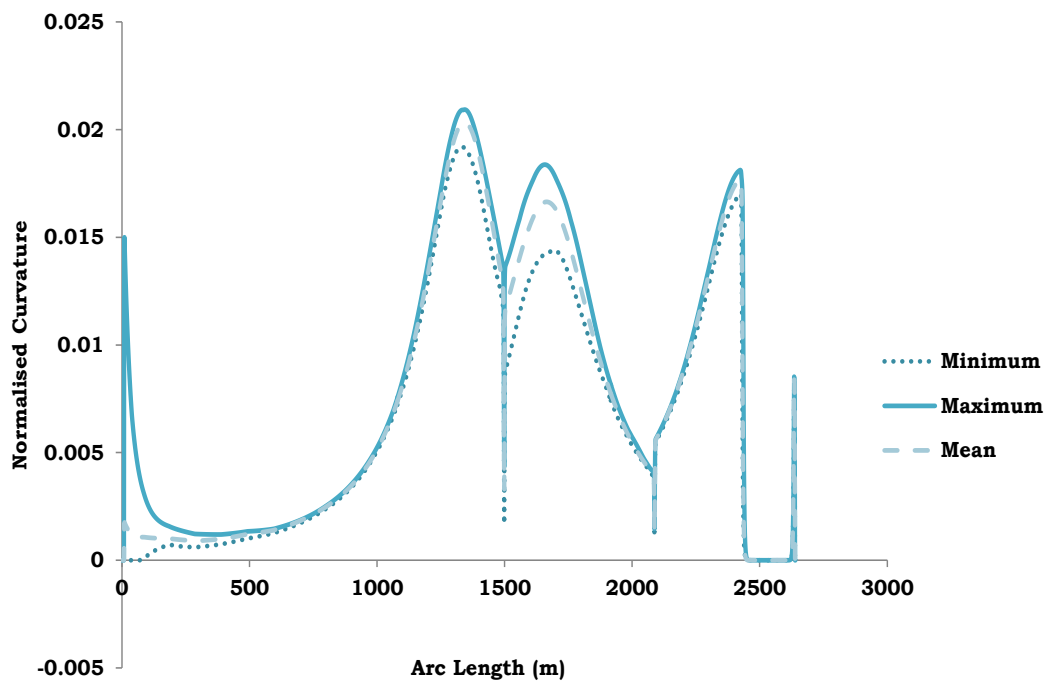

Figure 8.22 – Lazy Wave Flexible Riser Curvature for Dynamic Analysis

	Operational Condition			Accidental Condition	
	Near	Nominal	Far	Near	Far
Max: Top Tension (kN)	2098	2191	2237	2087	2270
Min: Tension (kN)	69	238	345	60	362
Minimum Radius (m)	101	191	268	93	286

Table 8.19 – Lazy Wave Flexible Riser Dynamic Analysis Result

Result Discussion:

Maximum tension in the riser occurs for far FPSO offset in case of one mooring line failure (ALS). This is due to same reasoning given under static analyses result discussion. The maximum dynamic tension is 2270kN which is lower than allowable tension of 2700kN for the flexible riser which indicates that riser will not fail in tension. Also since the minimum tension in the riser is positive, so it is not subjected to compression and hence no buckling occurs.

The minimum radius of the riser configuration occurs for near FPSO offset in case one mooring line fails (ALS). This is expected as FPSO is nearest to the riser anchorage point which tends to reduce the radii at sag bend, hog bend and TDP. Also the minimum radius for all vessel offsets is 93m which is greater than MBR of 4m for the riser, which is a must requirement for flexible risers.

Comparing the results of maximum top tension for SLWR and lazy wave flexible riser from Table 8.18 and Table 8.19 we see that for SLWR case maximum top tension is 1688kN while the same for flexible riser is 2270kN. This is evident as top tension is directly proportional to the per meter weight of the riser which is larger for flexible riser than steel riser.

8.9 Fatigue Analysis

8.9.1 General

The risers are subjected to cyclic loads which can cause the fatigue damage risers. These cyclic loads are caused by number of sources the most important of which are [DNV-OS-F201, 2010]:

- 1. First Order Wave Effects:** It includes the fatigue damage on the riser due to direct impact of waves and Wave Frequency (WF) FPSO motions, hence being the major contributor to the riser fatigue damage. This is because of FPSO's heave, roll and pitch period lie in the same frequency range of wave energy, and cause enormous dynamic response of the riser.
- 2. Second Order Floater Motions:** It includes fatigue damage due to wave induced floater motions at frequency lower than natural frequency.
- 3. Vortex Induced Vibration (VIV):** Besides wave loads, riser is also subjected to the current effects which can cause formation of eddies and the phenomenon is called as vortex shedding. In case the vortex shedding frequency matches with the natural frequency of riser it can cause riser to vibrate enormously which can thus cause its fatigue damage. It has been discussed theoretically in section 8.9.4.

One of the design requirements is that riser should have sufficient fatigue life during its operational service lifetime. For steel risers the fatigue failures generally occurs at girth welds joining the line pipes together hence it is easy to calculate their fatigue life, but doing the same for flexible riser is a very cumbersome process due to its complex construction. Thus in this thesis only the fatigue life calculation of SLWR due to first order wave effects will be done. However fatigue life calculation of flexible riser will be discussed theoretically.

8.9.2 SLWR Fatigue Parameter

Riser Configuration: Fatigue analysis will be done for load case 1 mentioned in table 7.15.

Wave Data: The wave data of Aasta Hansteen field has been used to compute fatigue life of the SLWR. 18 representative sea states considered from the entire Hs-Tp plot are shown in Figure 8.23.

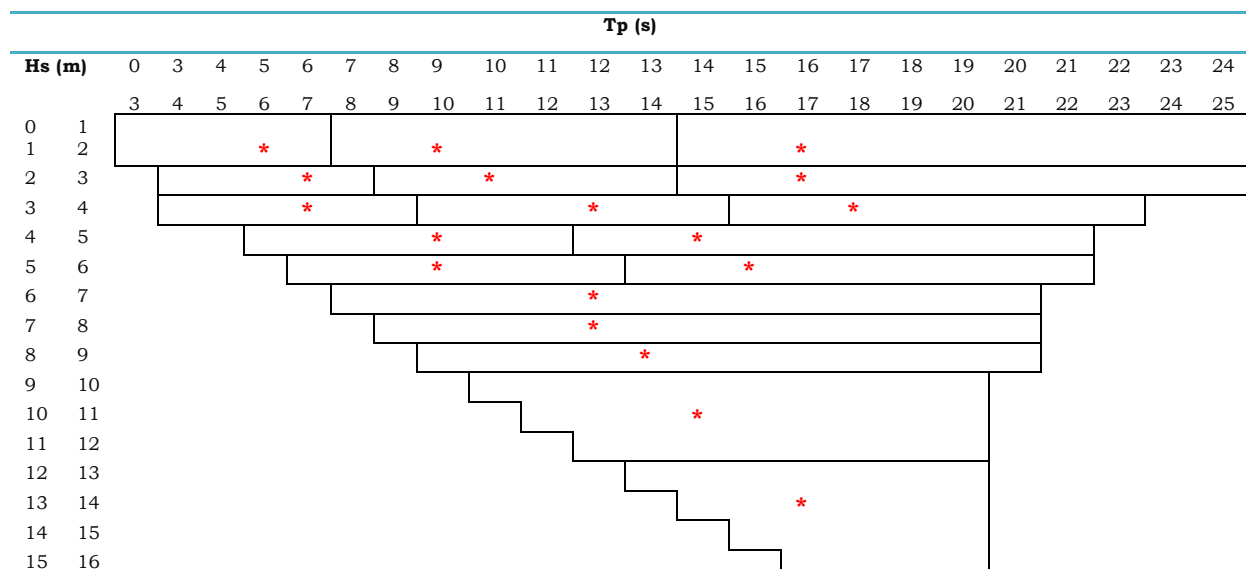

Figure 8.23 – Representative Sea State for Fatigue Analysis

12 wave directions have been used for the analysis and its fatigue probability is shown in Figure 8.24.

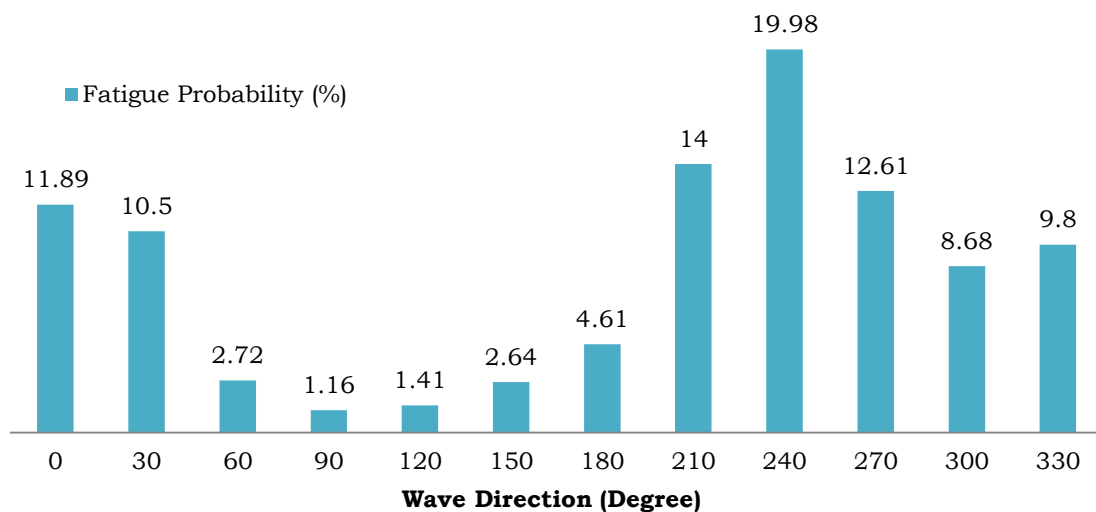

Figure 8.24 – Fatigue Wave Probability per Direction

S-N Curve and Stress Concentration Factor (SCF): The SCF of 1.2 and S-N (sea water and cathodic protection) curves C2 and D (DNV-RP-C203, 2010) are used to calculate fatigue damage of SLWR at critical locations namely hang off, sag bend, hog bend and TDP. The Design Fatigue Factor (DFF) of 10 is used as we are considering high safety class for the riser.

8.9.3 SLWR Fatigue Result- First Order Wave Effect

The fatigue analysis is performed for 2700s using Orcaflex and the results indicate the minimum fatigue life of the riser. The minimum fatigue life of the riser for different wave directions is shown in Figure 8.25

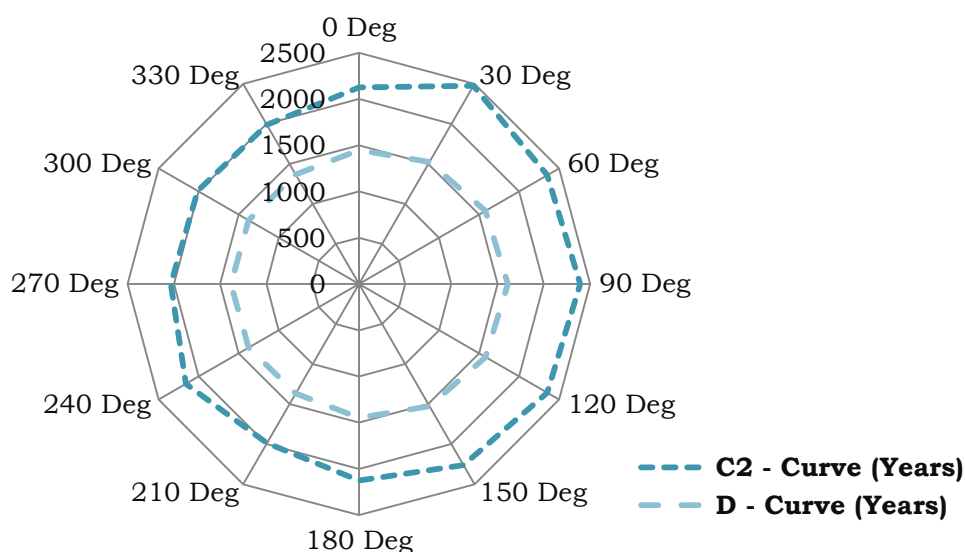

Figure 8.25 – Minimum Fatigue Life of Steel Lazy Wave Riser for Various Wave Directions

From Figure 8.25 it is clearly visible that for C2 curve minimum fatigue life of SLWR is more than 2000 years for all the wave directions. Also it can be seen that for D curve the fatigue life is reduced but still it is more than 1300 years for various wave directions. The detailed fatigue results for all the directions can be found in Appendix C while the results for wave direction 210 at which the worst fatigue damage occurs are presented below.

For SLWR the critical locations along its length are hang off, sag bend, hog bend and TDP. The minimum fatigue life at these locations is presented in Table 8.20.

Curve	Minimum Fatigue Life (Years)	Location on SLWR	Wave Direction (Degree)
C2	1987	Hang-Off	210
D	1367	Hang-Off	210
C2	>10000	Sag Bend	210
D	>10000	Sag Bend	210
C2	>10000	Hog Bend	210
D	>10000	Hog Bend	210
C2	>10000	TDP	210
D	>10000	TDP	210

Table 8.20 – Minimum Fatigue Life at Various Locations of SLWR

Table 8.20 clearly indicates that minimum fatigue life for SLWR occurs at hang off location for wave direction 210 degree. The plot of minimum fatigue life for C2 and D curve near hang off region, sag bend, hog bend and TDP for wave direction 210 degree is shown in Figure 8.26, Figure 8.27, Figure 8.28 and Figure 8.29 respectively.

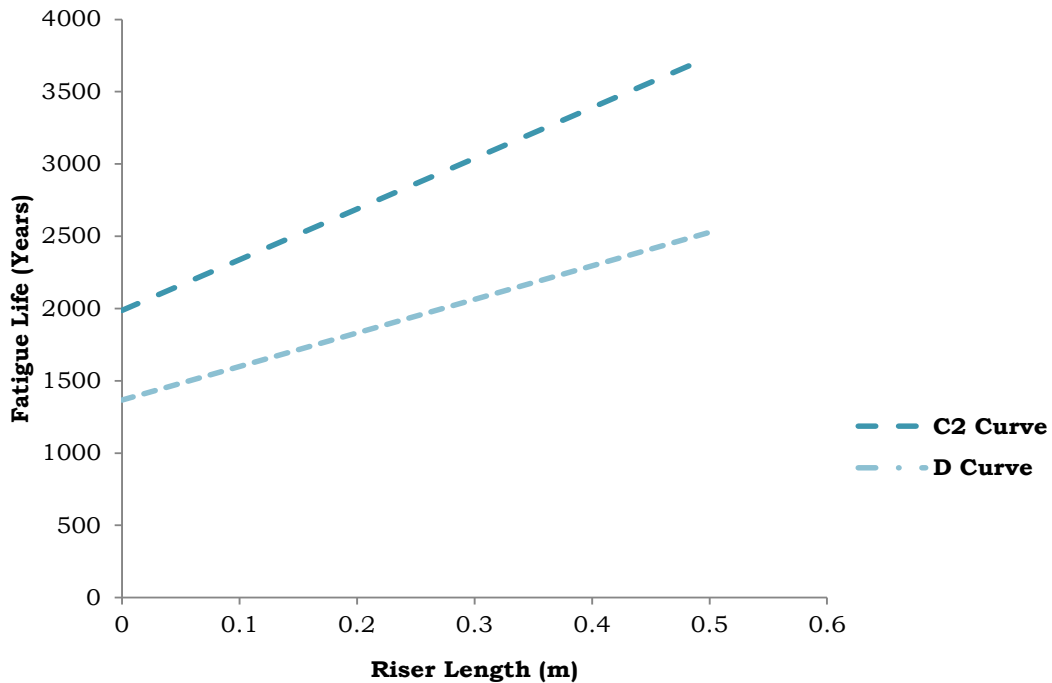

Figure 8.26 – Fatigue Life of Steel Lazy Wave Riser near Hang - Off Location

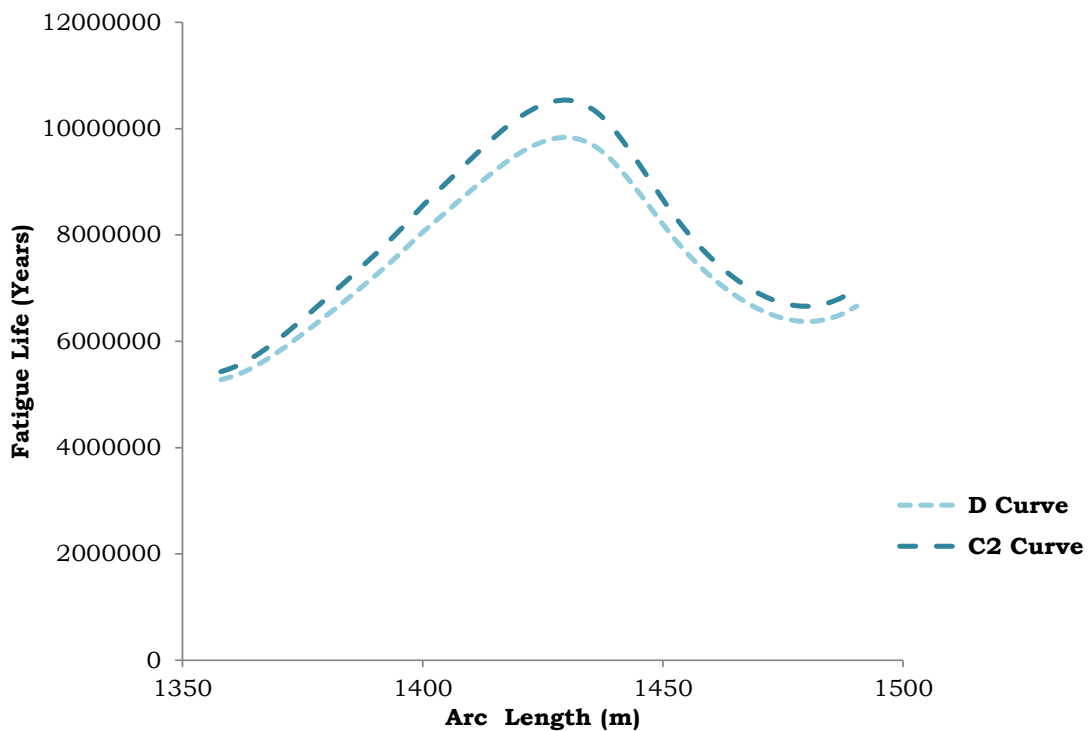

Figure 8.27 – Fatigue Life of Steel Lazy Wave Riser in Sag Bend Region

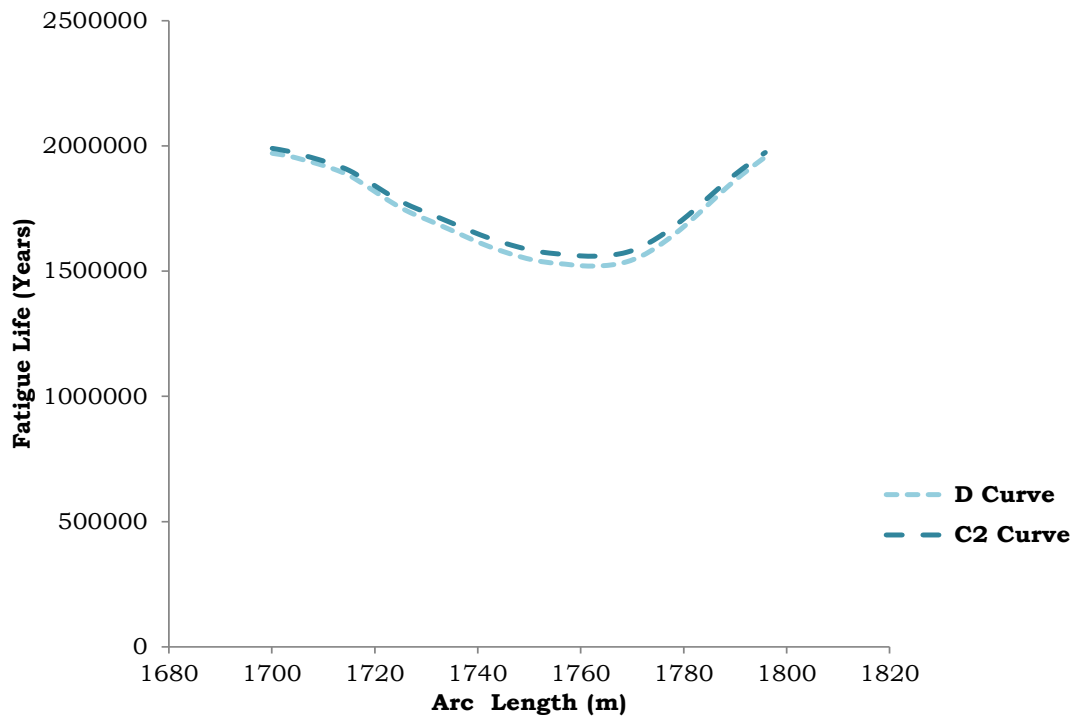

Figure 8.28 – Fatigue Life of Steel Lazy Wave Riser in Hog Bend Region

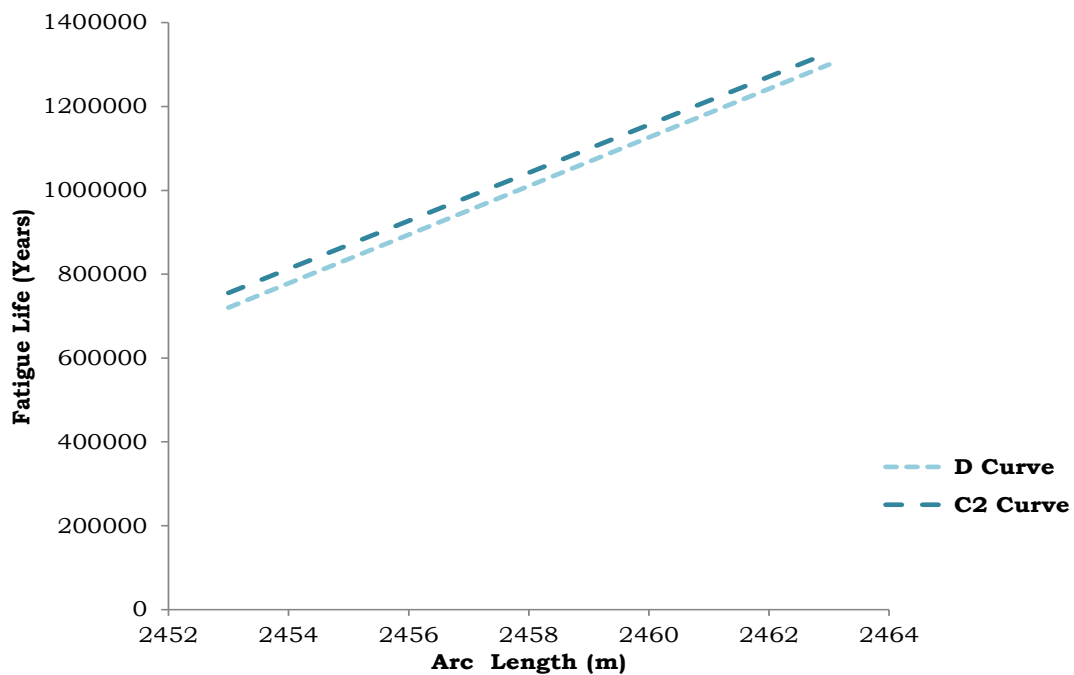

Figure 8.29 – Fatigue Life of Steel Lazy Wave Riser near TDP

Result Discussion: From the table and graphs it can be said that minimum fatigue life of the riser occurs at hang off location and is 1367 years according to D curve. Even after using the DFF of 10 we still get a fatigue life of 136 years which is way larger than service life of 25 years. Hence the designed SLWR configuration is having a robust fatigue performance.

8.9.4 SLWR Fatigue - VIV

Besides wave loads, riser is also subjected to the current effects which lead to the phenomenon called as vortex shedding. The vortex shedding frequency has a tendency to lock in to Eigen frequency of riser thus causing it to vibrate enormously. These vibrations are called as Vortex Induced Vibrations (VIV) and they can cause severe fatigue damage of risers like TTRs and relatively less severe for SCRs and SLWRs.

The oscillation of the riser can occur either in plane orthogonal to the current flow or in the current flow direction as shown in Figure 8.30. The former one is called as cross flow while the latter one is called as in line flow. Amongst the two, cross flow vibrations are more significant and can cause severe fatigue damage to the riser.

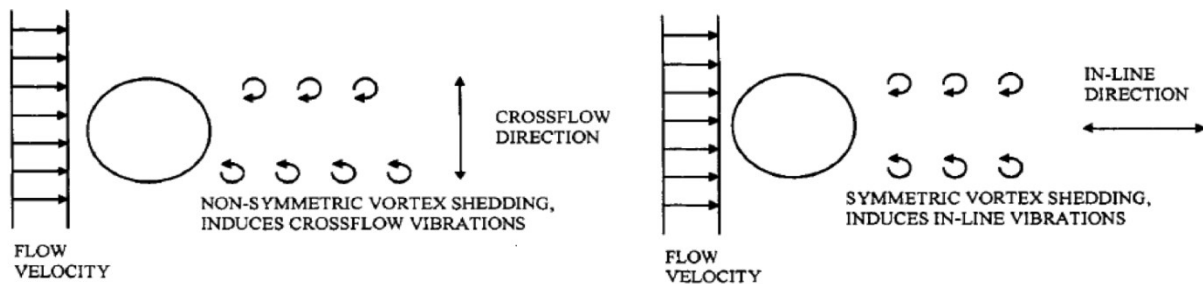

Figure 8.30 – Cross Flow and In-line Flow Vibration [Bai & Bai, 2005]

For deepwater risers in harsh environmental conditions, VIV becomes more critical due to following reasons [Bai & Bai, 2005]:

1. In deeper waters currents have stronger intensity than in shallow water.
2. Risers connected to FPSO have no structural support to clamp it due to which they vibrate even under the influence of small intensity currents.
3. With the increase in riser length for deepwater applications, its natural frequency is reduced which means it can be excited even with small intensity currents.

Besides this deepwater currents continuously change their magnitude and direction with depth as shown in Figure 8.31. Due to this multiple modes of excitation of the riser are enabled, thus making VIV fatigue estimation more complex.

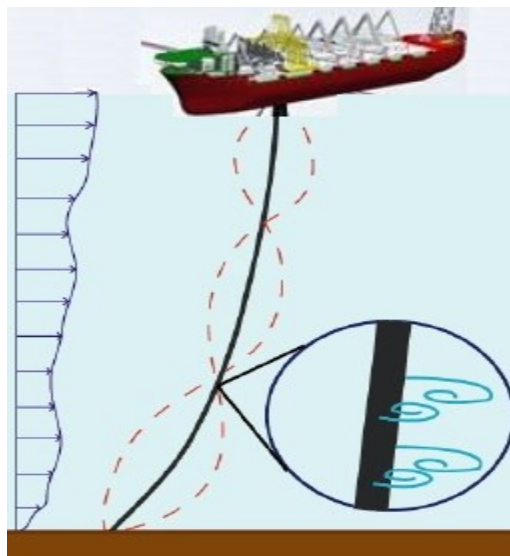

Figure 8.31 – Deepwater Riser Subjected to VIV

However even after complex nature of VIV analysis, it is obligatory to perform the analysis during the riser design. At present mainly two softwares SHEAR7 and VIVANA are used to do so. The analysis procedure as stated in user manual of VIVANA is as follows:

1. Perform static analysis to determine riser configuration based on boundary conditions.
2. Perform eigen value analysis in still water to calculate eigen frequencies and associated mode shapes of the riser. User inserts the added mass in this analysis.
3. Identify the most dominating eigen frequencies and associate them to an excitation zone.
4. Perform dynamic analysis of the dominating frequency identified in step 3. The analysis involves iteration to converge nonlinear models for any excitation and damping.
5. Calculate the fatigue damage using S-N approach for each direction and then add up the fatigue damage for various current directions and magnitudes to get total estimated fatigue damage.

Once fatigue damage due to VIV has been estimated suitable factors are applied on to it depending upon the safety class. If the factored fatigue life is greater than service life of riser then the design is rendered safe. However it is a common industry practice to use VIV suppression devices like helical strakes, fairings to reduce VIV of the riser which thus helps in increasing the fatigue life of the riser.

Due to limitation of time detailed VIV analysis is not the part of this case study. However from past section we got a fatigue life of 136 years (after DFF of 10). Now even if we reserve 50% of 136 years for VIV fatigue we are still left with 68 years of fatigue life which is still greater than service life of 25 years hence showing that SLWR has robust fatigue performance.

8.9.5 Flexible Riser Fatigue

Fatigue analysis of flexible riser is a daunting task due to its complex construction consisting of multiple layers and helical steel armors. As stated in API RP 17B “fatigue calculations for flexible risers involve substantial uncertainties because of simplifications in the long term load data and mathematical models, and complexities in the wear and fatigue process”.

As discussed in section 5.2 of this thesis that flexible risers when used with FPSO in harsh environmental conditions must have complaint configuration to accommodate floater motions. Complaint configuration like lazy wave requires high bending ability of flexible riser which is provided by helical elements in its unbonded structure. During bending of the flexible pipe the helical armors stick to the pipe and once the bending force is removed they slip to release the axial stresses originated due to bending. This mechanism is shown in Figure 8.32.

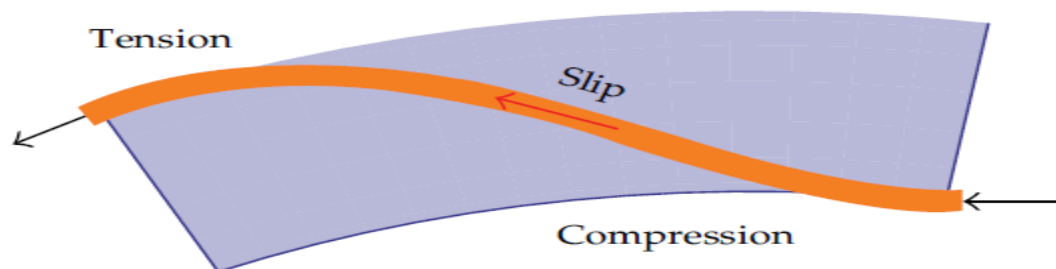

Figure 8.32 – Slipping of Helical Armors during Bending of Flexible Pipe [Skeie et al, 2012]

Thus helical geometry of armors in the flexible pipe provides the necessary bending flexibility on one hand, but on the other hand they add complexity to the fatigue analysis process due to its stick slip mechanism explained above.

For flexible riser, fatigue damage due to first order wave effects dominates VIV fatigue damage. This is due to large damping factor of flexible riser which makes it less prone to VIV fatigue damage [Bai & Bai, 2005]. Hence forth only discussion related to fatigue damage due to first order wave effects will be done.

The fatigue damage of steel armors is accelerated in the presence of water in case internal pressure sheath is unable to prevent the moisture ingress from carcass. This condition could be exacerbated if external sheath is damaged to the extent that seawater ingress takes place into the annulus thus causing corrosive fatigue damage of the steel wires.

The main aim of the fatigue analysis is to calculate the fatigue damage due to long term dynamic loads in critical locations of the riser at various hot spots on the helical armors. One critical location for flexible riser is generally the hang off location due to presence of combined bending and tension loads at the top. Another critical position is the TDP due to combined presence of bending loads and high hydrostatic pressure. The hot spots are along the helical element as shown in Figure 8.33.

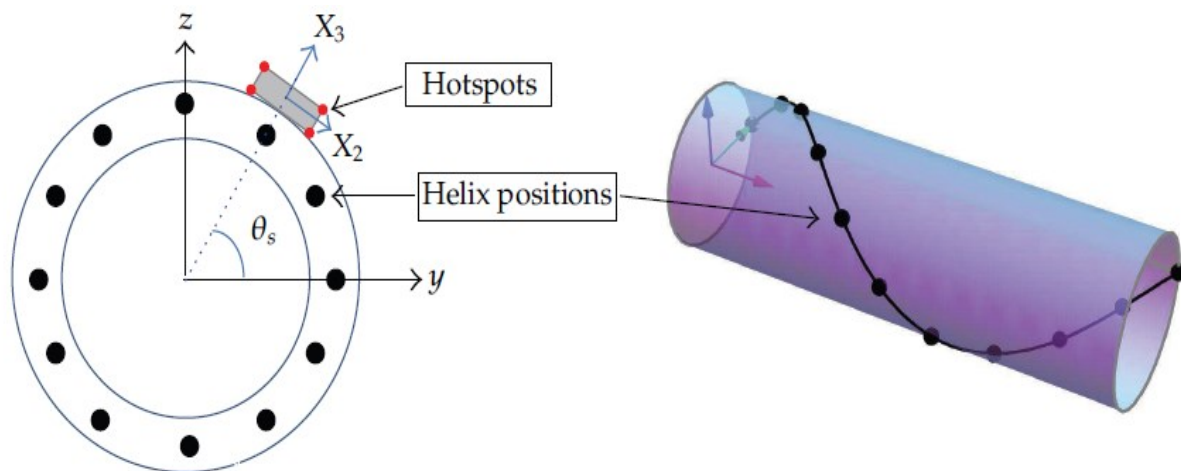

Figure 8.33 – Critical Hotspots and Helix Position for Fatigue Analysis [Skeie et al, 2012]

At each of these hot spots fatigue calculation is to be carried out for several random sea states each having duration of about 60 minutes. Thus vast computational work further complicates the analysis process.

DNV has developed commercial software named Helica which can calculate the fatigue damage in helical armors of the riser. Some of the main capabilities of the software are [Dhaigude and Sharma, 2104]:

- Short term fatigue life calculations.
- Long term fatigue life calculations.
- Fatigue stress analysis for helical armors.

The software allows each helical layer to be modeled as an equivalent tube model having the stiffness properties of the armor itself. A detailed cross sectional analysis is then done in order to estimate local stresses in each of the inner armor wire due to global external

loading. To facilitate the cross sectional analysis loads are segregated into two parts as shown in Figure 8.34 and as stated below [Skeie et al, 2012]:

- Axially symmetric loads due to effective tension, internal and external pressure.
- Pure bending loads arising due to global riser curvature.

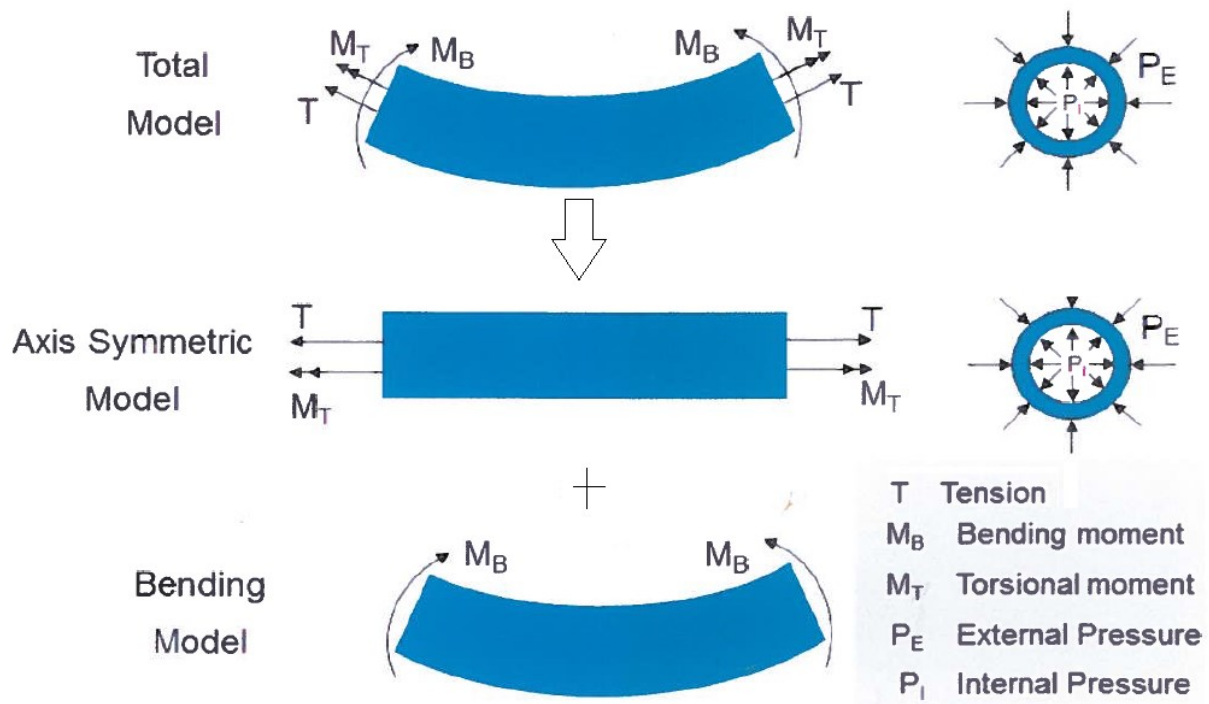

Figure 8.34 – Response Models for Cross-Sectional Analysis [Dhaigude and Sharma, 2104]

DNV has initiated a JIP with the aim of validating the above mentioned cross sectional analysis methodology of helical armors. The outcomes of the JIP will give offshore industry an efficient way to perform fatigue analysis of flexible risers.

Nevertheless the fatigue analysis procedure for flexible riser due to first order wave effects is stated below:

1. Divide the wave scatter diagram into sea state blocks as shown in Figure 8.23.
2. From each block a representative sea state is selected and nonlinear time domain analysis using Orcaflex/Riflex is performed for this sea state for all the wave directions.
3. Use Helica software to carry out short term fatigue analysis of the riser at critical hot spots on the helical. The input to this analysis is time history of effective tension and biaxial curvature generated from non-linear time domain analysis in step 2.
4. Use rain flow counting method to obtain cycle histogram from the fatigue stress time series generated in step 3.
5. Repeat step 2, 3 and 4 for all the sea state blocks in the wave scatter diagram.
6. Calculate fatigue damage by taking into account the probability of occurrence for short term condition.

The above procedure employed to calculate fatigue life of flexible riser is depicted in Table 8.21.

Main Input	Analysis	Main Output
Global Design		
Environmental loads, vessel motions, global flexible riser model.	Dynamic analysis using Orcaflex, Riflex etc.	Time histories of axial tension, bending curvature.
Local Design		
Cross section model, lay angle, axial symmetric loads like axial tension, torsion, and internal /external pressure from dynamic analysis.	Helica axis symmetric analysis.	Load sharing between cross section components, contact forces, stress/strain in components.
Bending curvature from dynamic analysis, friction coefficients, hot spot locations, and output from axis symmetric analysis.	Helica bending analysis.	Stress due to bending about local axis, Additional (friction) stress due to bending.
Short Term Fatigue Analysis		
Fatigue stress time series from Helica analysis, SN curve.	Helica analysis (Rainflow cycle counting).	Short term fatigue damage.
Fatigue damage for all short term conditions, probability of each short term condition.	Long term fatigue analysis.	Long term fatigue damage.

Table 8.21 – Fatigue Analysis Scheme [Dhaigude and Sharma, 2104]

The fatigue analysis is generally done by the manufacturer and he must guarantee that the fatigue life is 10 times larger than the service life [Bai & Bai, 2005].

Due to complexity and time limitation, fatigue analysis of flexible riser is not the part of this case study.

8.10 Comparison

8.10.1 General

While making a decision on riser concept selection large number of factors like fabrication cost, installation cost, vessel payload, development schedule, seabed layout and risk etc. should be considered. However due to limitation of time the above mentioned riser concepts i.e. lazy wave flexible riser and SLWR shall be compared on the basis of three important parameters namely vessel payload, fabrication cost and installation cost in this section of case study. All the three parameters play significant role in riser concept selection hence these are discussed next in detail.

8.10.2 Vessel Payload

From Table 8.18 and Table 8.19 it can be seen that maximum top tension or vessel payload for both the riser concepts occurs for accidental condition and far vessel offset position i.e. for load case 4.

The comparison is done for single riser and Figure 8.35 shows the plot of vessel payload for both the riser concepts.

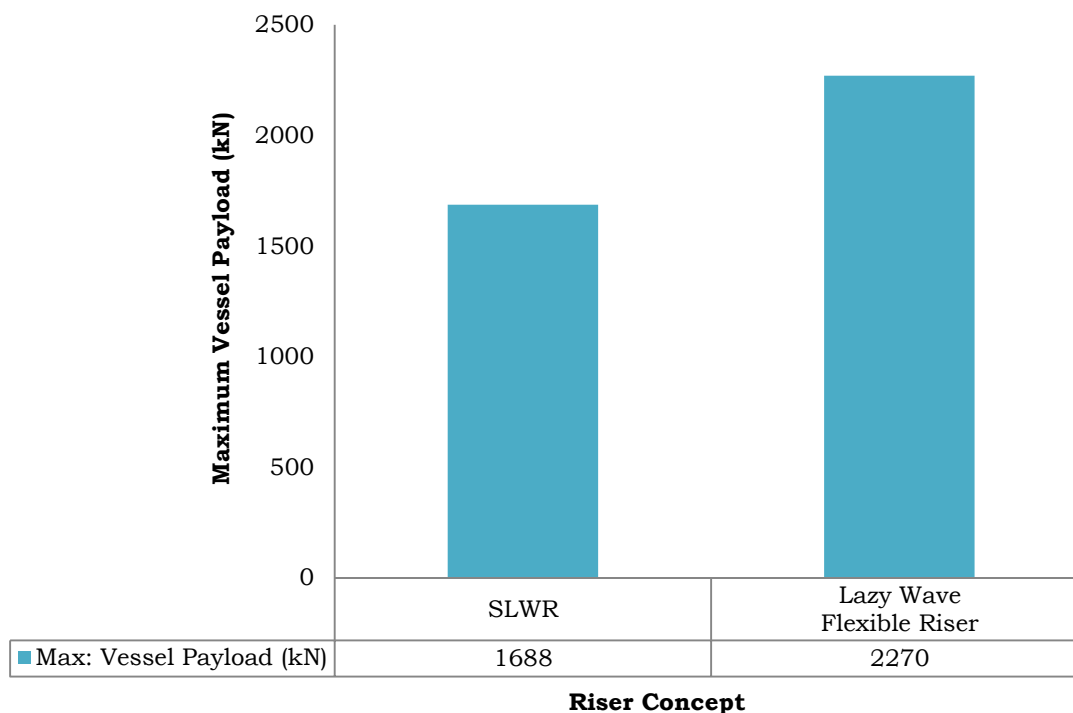

Figure 8.35 – Comparison of Vessel Payload for Single Lazy Wave Flexible Riser & SLWR

From Figure 8.35 it can be clearly seen that vessel payload for SLWR is 25.6% (582kN) lower than that of lazy wave flexible riser. Lower vessel payload has two main implications for FPSO. The first one is that for SLWR the structural reinforcement required at hang off location in the turret is lesser than that required for lazy wave flexible riser. This in turn results into large cost savings of millions of NOKs per riser.

The second implication is more crude storage capability in FPSO. This implication can be easily understood if we consider that the number of risers hooked up to FPSO is greater than one which generally is the case. For e.g. if we assume that 10 risers are hooked to FPSO then the payload difference between the two riser concepts would be 5820 kN (582000 tons). This means that for FPSO having SLWR concept more crude weight can be added provided there is no space limitation.

Thus from vessel payload point of view SLWR seems to be a preferred option for our case.

8.10.3 Cost

Another important parameter from riser concept selection point of view is its fabrication cost and installation cost. Due to less number of manufacturers of flexible pipe and monopolized market its cost is higher than steel riser. For this case study fabrication cost includes cost of the main riser pipe along with its ancillary components while installation cost includes cost of installing the riser and its hook up to FPSO. An effort has been made to accurately estimate the price of the designed riser concepts used in this case study.

Fabrication Cost: The cost of the designed flexible riser used in this case study has been taken from one of the leading manufacturers and includes the cost of riser, bend stiffener, end fitting and buoyancy module.

The fabrication cost of the designed SLWR used in this case study has been taken from EMAS-AMC AS. The cost includes prices of steel, insulation, welding and buoyancy modules. The price of flex joint has been taken from Hutchinson Engineering Group. All the price details can be found in Appendix B.

The fabrication cost of single riser for both the concepts used in this case study is plotted in Figure 8.36.

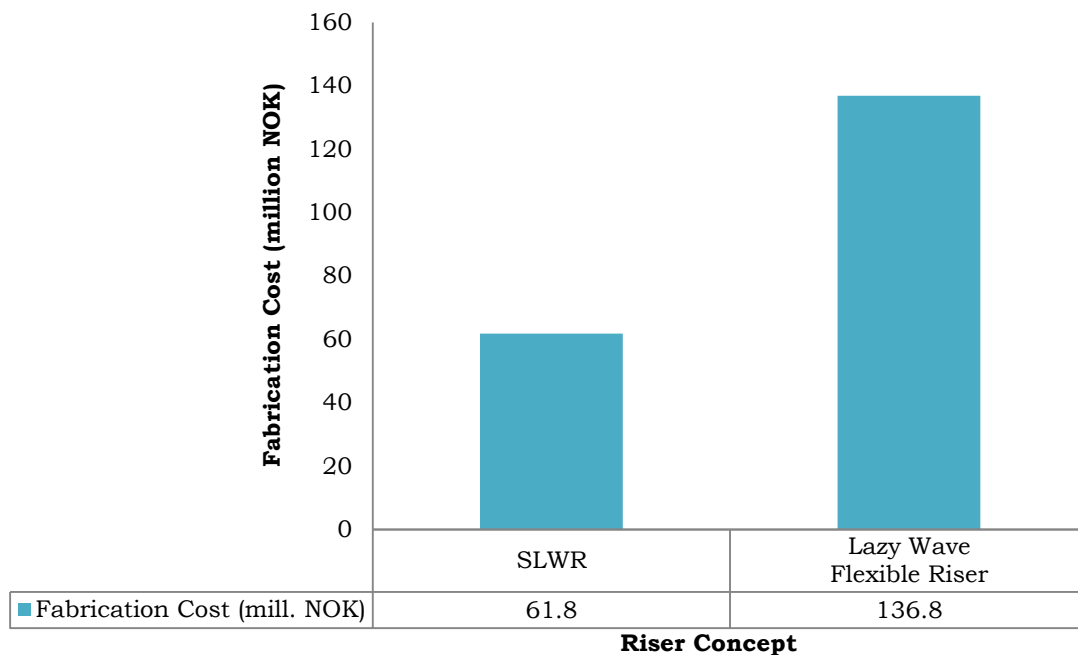

Figure 8.36 – Comparison of Fabrication Cost for Single Lazy Wave Flexible Riser & SLWR

From Figure 8.36 it can be said that fabrication cost of SLWR is about 55% (75 million NOK) lower than that of lazy wave flexible riser. Thus from fabrication cost point of view SLWR seems to be a preferred option for our case.

Installation Cost: The installation cost of flexible riser is generally lower than SLWR; this is primarily due to two reasons:

- First is the lower day rate of Installation Vessel (IV) of flexible riser as compared to day rate of IV of SLWR. The rate of typical IV for flexible riser is 1.53 million NOK/day, while the rate for IV for SLWR is 2.45 million NOK /day. These rates have been given by EMAS AMC AS.
- Second is faster installation rate and hook up time of flexible riser as compared to SLWR. For flexible riser the installation rate up to 600m/hour can be achieved while the same for SLWR is about 300m/hour. Also hook up time for flexible riser is less than that for SLWR because of relatively simple hook up process. Thus for our case of 3000m riser length, it is assumed that single flexible riser can be installed and hooked to FPSO in one day while the same length of single SLWR will require 3 days for installation and hook up. Detailed cost can be found in Appendix B.

Thus plotting the installation cost on the graph we get Figure 8.37.

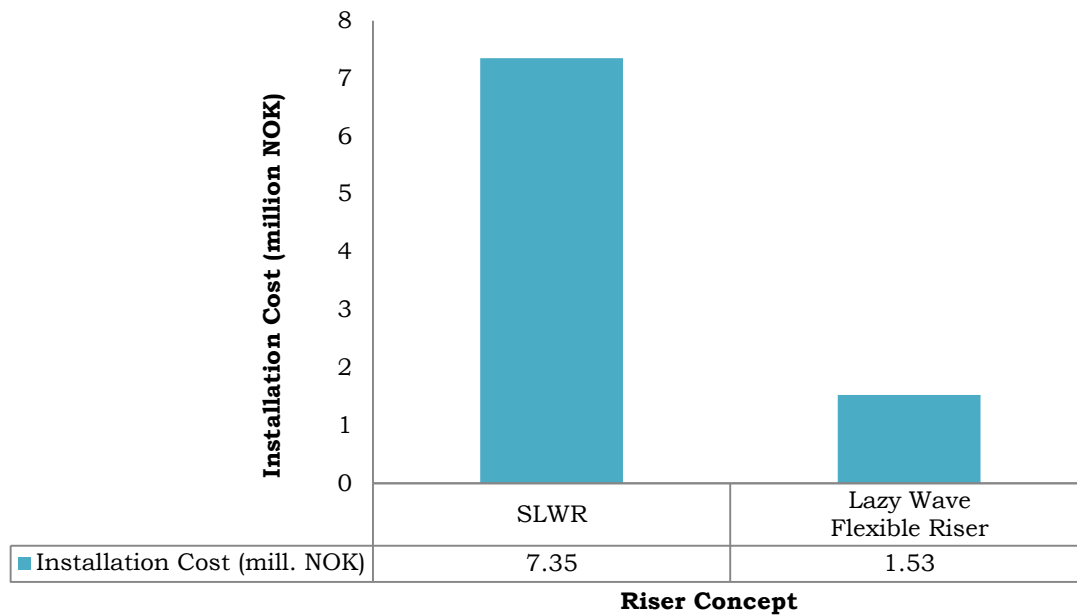

Figure 8.37 – Comparison of Installation Cost for Single Lazy Wave Flexible Riser & SLWR

On plotting total cost (i.e. fabrication cost and installation cost) together we get Figure 8.38.

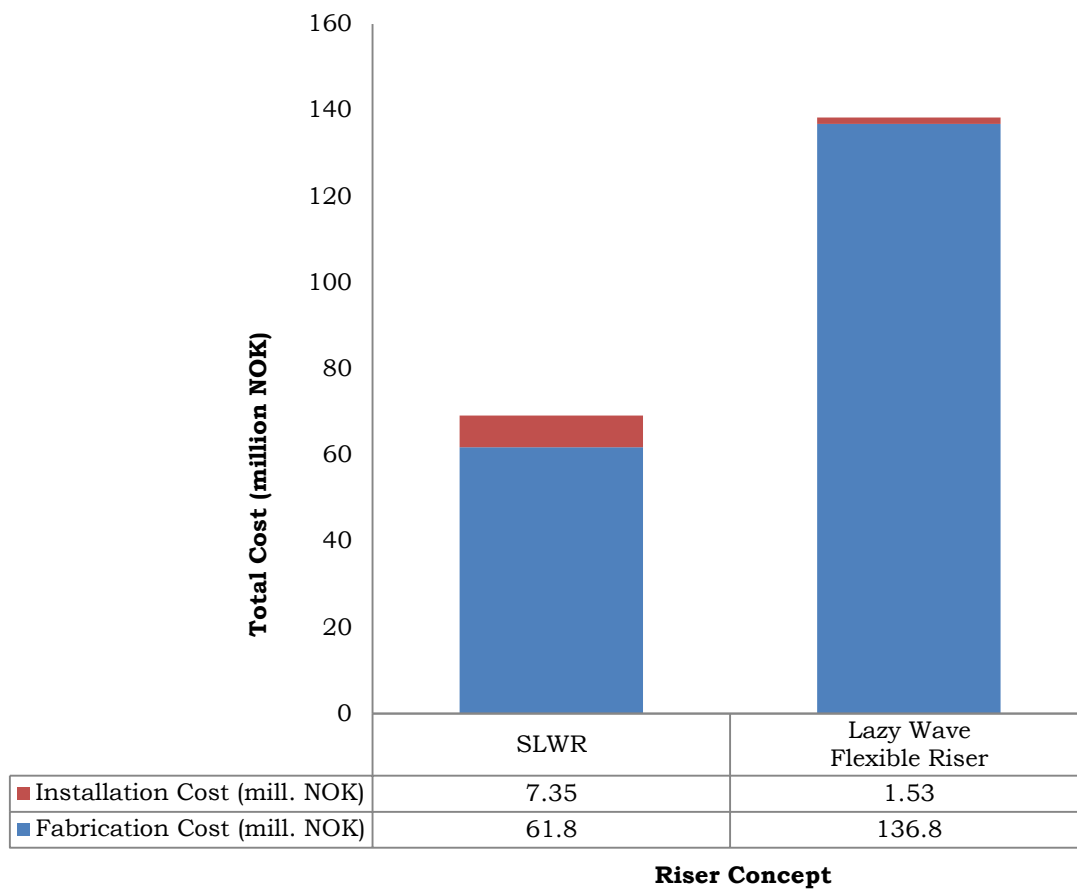

Figure 8.38 – Comparison of Total Cost for Single Lazy Wave Flexible Riser & SLWR

From Figure 8.38 it can be said that though installation cost of SLWR is larger than flexible riser still total cost (i.e. fabrication cost and installation cost) of SLWR is about 50% (69.18

million NOK) lower than lazy wave flexible riser. This difference in cost further increases as the number of risers hooked to the FPSO increases. For e.g. the cost difference between the two riser concepts would become 691.8 million NOK if 10 risers are hooked to FPSO. Hence enormous cost savings can be made by selecting SLWR over lazy wave flexible riser.

8.10.4 Recommendation

Based on above three factors namely vessel payload, fabrication cost and installation cost it can be said that for our case SLWR is undoubtedly preferred riser concept for FPSO stationed in deepwater (1500m) in Northern Norwegian Sea.

8.11 Discussion and Conclusion

The key conclusions that can be made from the chapter are:

- 1.** The static and dynamic analysis of SLWR shows that the riser is not subjected to compression for any load case. This indicates that riser doesn't undergo buckling during its service life which is desirable. Also the maximum LRFD stress utilization for all load cases is below 1 which means that maximum stress in the riser is below SMYS of steel riser.
- 2.** The static and dynamic analysis of lazy wave flexible riser shows that it is not subjected to compression for any load case. This indicates that riser doesn't undergo birdcaging during its service life which is desirable. Also the minimum radius is greater than MBR of 4m for the riser which is a must requirement for safe riser operation.
- 3.** The top tension of lazy wave flexible riser is larger than SLWR which is obvious due to more per meter weight of flexible riser as compared to steel riser. It means that payload on FPSO due lazy wave flexible riser will be more than SLWR.
- 4.** The fatigue analysis of SLWR showed that minimum fatigue life of 1367 years occurs at hang off location for 210 degree wave direction. For other critical locations like sag bend, hog bend and TDP the fatigue life is greater than 10000 years. Even after applying DFF of 10, and reserving 50% of life for VIV fatigue, the fatigue life comes out to be 68 years which is way higher than service life of 25 years for the SLWR. Hence SLWR is robust from fatigue point of view.
- 5.** Fatigue analysis of flexible riser is a daunting task due to its complex construction and generally the manufacturer guarantees that fatigue life will be minimum 10 times the service life of the riser.
- 6.** DNVs commercial software Helica can be used to calculate fatigue life of flexible riser. At present a JIP is being carried on to validate the stress calculation method of the software.
- 7.** Vessel payload due to SLWR is 25.6% lower than lazy wave flexible riser, which means that large cost savings can be made due to less structural reinforcement requirement at hang off position in turret.
- 8.** The total cost of the designed SLWR is about 50% (69.18 million NOK) lower than designed lazy wave flexible riser, which means that enormous cost savings can be made by choosing SLWR over lazy wave flexible riser.

9 CONCLUSION & RECOMMENDATION

9.1 Conclusion

On the basis of literature review and case study performed in this thesis following conclusions can be made:

- FPSOs have dominated the FPU concept selection till now and in the future also it seems they will continue to do so. The reason for their widespread use can be accounted to number of advantages offered by FPSO, few of which are: inherent crude storage facility, ability to use it for pilot production and ability to weather vane etc.
- The type of FPSO to be used at particular offshore location is dependent upon the environmental conditions prevalent in the region where FPSO is to be stationed. For e.g. spread moored FPSO are generally used in benign environments of WoA while turret moored FPSO are dominant in offshore Brazil having moderate environment and North Sea having harsh environmental conditions.
- Designing riser for deepwater FPSO stationed in harsh environmental conditions is a daunting task. This can be accounted to factors like large vessel payload, high hydrostatic pressure, increased heat loss and large vessel offset etc.
- While for designing unbonded flexible risers, API RP 17B and API Specification 17J employing WSD methodology is used, the design of rigid (metallic) risers may follow recommendations of API RP 2RD (WSD) or of DNV-OS-F201 which adopts the new LRFD format
- Till now variety of riser concepts like flexible riser, SCR, SLWR, HRT, SHR and BSR have been used with FPSO in deepwater. The coupled riser concepts like free hanging flexible have dominated the field development concept with turret moored FPSO in water depths up to 1500m and moderate environments of Brazil. However SCR and the uncoupled risers like SHR/HRT are mostly installed in benign environments of WoA.
- The main reason for widespread use of unbonded flexible riser with deepwater FPSO is due to their flexibility which allows flexible riser to accommodate large vessel offsets and also to be spooled on reels/carrousel for storage and installation purposes. Being a proved technology and ability to re-use them is an added advantage but tendency to collapse and birdcage, large cost, small number of manufacturers and large vessel payload are some of its disadvantages.
- To overcome the disadvantages of flexible riser, industry is trying to enable new flexible pipe like unbonded hybrid composite and unbonded non-metallic which can be used in ultra-deepwater (>1800m) and sour service conditions. The benefits offered by these two technological innovations are light weight, better fatigue performance, suitability for sour service condition and corrosion resistance. However all these advantages come with increased cost hence operators have shifted focus on its alternative like SCR, SLWR, SHR and HRT.

- Steel risers are preferred over flexible riser for deep water because of their lower cost, less vessel payload and high collapse resistance even at large diameters. However even SCR suffers from drawbacks like low fatigue life of hang off and TDP, large subsea footprint area and clashing issues. One way to increase fatigue life and reduce vessel payload is to modify the SCR configuration to SLWR by use of buoyancy modules. Also it is a common industry practice to use metallurgical clad/mechanically lined pipe near hang-off location and TDZ of SCR in order to improve its fatigue life.
- In order to reduce large vessel payloads imposed by coupled riser concepts like free hanging flexible riser and SCR industry has started using uncoupled riser concepts like HRT, SHR and BSR. Till now all the HRTs and most of the SHRs have been installed with deepwater FPSO stationed in benign environments of WoA. This is due to the fact that HRTs are generally towed to site and hence are very susceptible to installation fatigue which can be enormous for moderate and harsh environments.
- The main advantages of hybrid risers are reduced vessel payload, robustness, better dynamic performance, low operational fatigue, high local content and optimum field layout. While some of its disadvantages are requirement of complex, bulky, expensive bottom assemblies and clashing issues amongst adjacent risers, jumpers and umbilicals.
- Till now there no FPSOs stationed in water depth of 1500m in harsh environmental conditions of Northern Norwegian Sea. So a case study is done for such a case to find a relevant riser concept which can be hooked to internal turret moored FPSO.
- The strength analysis of both the riser concept namely lazy wave flexible riser and SLWR indicates that they do not undergo compression. Also flexible riser fulfills MBR criteria and for SLWR LRF utilization is less than one for all cases which is desirable. Based on the static and dynamic analysis of both riser concepts it can be said that they exhibit good strength performance.
- Fatigue analysis of SLWR indicates that it has fatigue life which is far greater than minimum service life thereby showing excellent fatigue performance. Also it can be said that fatigue analysis of flexible riser is a complex process due to its multi layered construction and helical steel armors. Generally manufacturer of flexible rise performs this analysis and guarantees that fatigue life will be minimum 10 times the service life of the riser.
- Based on the analysis the vessel payload due to SLWR is 25.6% lower than lazy wave flexible riser, which means that large cost savings can be made due to less structural reinforcement requirement at hang off position in turret. Also case study indicates that total cost (fabrication cost and installation cost) of the designed SLWR is about 50% (69.18 million NOK) lower than designed lazy wave flexible riser, which means that enormous cost savings can be made by choosing SLWR over lazy wave flexible riser.

9.2 Recommendation

- Based on the case study performed in the thesis it is recommended to use SLWR over lazy wave flexible riser with the deepwater FPSO stationed at 1500m water depth and harsh environmental conditions of Northern Norwegian Sea.

- For better understanding of the dynamic behavior of the riser concept it is recommended to perform sensitivity analysis of the lazy wave configuration. The variables in the sensitivity analysis could be hang-off angle and buoyant section length.
- It is also recommended to perform installation analysis of the both the risers in particular for SLWR. This is because during installation of the riser the chances of buckling and compression are high which must be checked for.
- If possible fatigue analysis of flexible riser should also be performed though it is a complex task. Also it is recommended to perform fatigue analysis arising due to VIV on SLWR.
- Besides comparing the two riser concepts considered in the case study on basis of vessel payload, fabrication cost and installation cost it is highly recommended to perform additional comparison between the two riser concepts on factors like maintenance, development schedule, seabed layout, safety and risk etc.

10 REFERENCE

10.1 Literature Reference

Anderson, K. and Connor, M.O. (2012). The Evolution of Lazy-S Flexible Riser Configuration Design for Harsh Environments. In: International Conference on Ocean, Offshore and Arctic Engineering, Rio de Janeiro, Brazil, 1-6 July 2012. MCS Kenny.

Andersen, J.B., Andersen, L.W., Braestrup, M.W., Bryndum, M.B., Christensen, C.J. and Rishøj, N. (2005). Design and Installation of Marine Pipelines. First Edition. John Wiley and Sons.

Andrew, B. and Eyles, T. (2010). Efficient Global Analysis and Local Analysis of Single Leg Hybrid Risers. In: International Offshore Pipeline Forum, Houston, USA, 20-21 October 2010. 2H Offshore Engineering Ltd.

Antal, A., Nagy, T. and Boros, A. (2003). Improvement of Bonded Flexible Pipes According to New API Standard 17K. In: Offshore Technology Conference, Houston, USA, 5-8 May 2003. Phoenix Rubber Industrial Ltd.

API (2011). Recommended Practice API 17A – Design and Operation of Subsea Production Systems-General Requirements and Recommendations, Fourth Edition, Reaffirmed 2011. Washington D.C., USA. American Petroleum Institute.

API (1998). Recommended Practice API 2RD – Design of Risers for Floating Production Systems and Tension Leg Platforms. Washington D.C., USA. American Petroleum Institute.

API (2008). Recommended Practice API 17B – Recommended Practice for Flexible Risers. Washington D.C., USA. American Petroleum Institute.

API (2008). Specification for Unbonded Flexible Pipe-ANSI/API Specification 17J. Washington D.C., USA. American Petroleum Institute.

Bai, Y. and Bai, Q. (2005). Subsea Pipelines and Risers. Second Edition, UK: Elsevier Ltd.

Balmoral Offshore Engineering Catalogue, 2012. Taken from << <http://www.balmoral-group.com/balmoral-offshore-engineering/pdf/2-BOE-surf-web.pdf>>>. [Accessed on 13 March 2014].

Bartrop, N.D.P. (1998). Floating Structures: A Guide for Design and Analysis / Volume 1 and 2 (Publication 101/98). London: The Centre for Marine and Petroleum Technology

Bell, J.M., Chin, Y.D. and Hanrahan, S. (2005). State-of-the-Art of Ultra Deepwater Production Technologies. In: Offshore Technology Conference, Houston, USA, 2-5 May 2005. Chevron Texaco and Aker Kvaerner.

Bernard, G., Do, A.T. and Hanonge, D. (2013). Carbon Fibre Armors Applied to Presalt Flexible Pipe Developments. In: Offshore Technology Conference, Houston, USA, 6-9 May 2013. Technip.

Brandao, F.E.N. and Henriques, C.C.D. (2007). From P-34 to P-50: FPSO Evolution. In: Offshore Technology Conference, Houston, USA, 30 April-3 May 2007. Petrobras and Technip.

Butting Catalogue, 2008. Taken from <<<http://www.butting.com/en/mechanically-lined-pipes/>>>. [Accessed on 28 March 2014].

Bryant, M., Bhat, S.U. and Chen, B. (2007). Non-Metallic Unbonded Flexible Pipes for Deepwater. In: International Oil Conference and Exhibition, Veracruz, Mexico, 27-30 June 2007. DeepFlex Inc.

Chakrabarti, S.K. (2005). Handbook of Offshore Engineering Volume II. UK: Elsevier Ltd.

Clevelario, J. (2004). Introduction to Unbonded Flexible Pipe Design & Manufacturing. Wellstream International Limited.

Crome, T., Binet, E. and Mjøen, S. (2007). Smoothbore Flexible Riser for Gas Export. In: Offshore Technology Conference, Houston, USA, 30 April-3 May 2007. Technip.

Dhaigude, M. and Sharma, P.P. (2014). Developments in Computational Methods for Assessing Fatigue Life of Flexibles and Umbilicals. In: Offshore Technology Conference, Houston, USA, 5-8 May 2014. DNV USA Inc.

Do, A.T and Lambert, A. (2012). Qualification of Unbonded Flexible Riser with Carbon Fibre Composite Armors. In: Offshore Technology Conference, Houston, USA, 30 April-3 May 2012. Technip.

DNV. (2010). Offshore Service Specification DNV-OSS-302 Offshore Riser Systems, October 2010. Høvik, Norway: Det Norske Veritas.

DNV. (2010). Offshore Standard DNV-OS-F201 Dynamic Risers, October 2010. Høvik, Norway: Det Norske Veritas.

DNV. (2010). Recommended Practice DNV-RP-C203 Fatigue Design of Offshore Steel Structures, April 2010. Høvik, Norway: Det Norske Veritas.

DNV. (2010). Recommended Practice DNV-RP-C205 Environmental Conditions and Environmental Loads, October 2010. Høvik, Norway: Det Norske Veritas.

DNV. (2010). Recommended Practice DNV-RP-F204 Riser Fatigue, October 2010. Høvik, Norway: Det Norske Veritas.

DNV. (2010). Recommended Practice DNV-RP-F205 Global Performance Analysis of Deepwater Floating Structures, October 2010. Høvik, Norway: Det Norske Veritas.

Duan, M., Chen, J. and Li, Z. (2011). Mechanics of Deepwater Steel Catenary Riser. Offshore Oil/Gas Research Center, China University of Petroleum, Beijing.

Eyles, T. And Lim, F. (2006). The Need for Standardizing Deepwater Riser Systems. In: Offshore Drilling and Deepwater/Underwater Technologies, Kuala Lumpur, Malaysia, 27-28 November 2006. 2H Offshore Engineering Ltd.

Fisher, E.A and Berner, P.C. (1988). Non-Integral Production Riser for Green Canyon Block 29 Development. In: Offshore Technology Conference, Houston, USA, 2 May 1988. Cameron Offshore Engineering Inc.

Foyt, E., Griffin, G. and Campbell, M. (2007). Weight Optimized SCR – Enabling Technology for Turret Moored FPSO Developments. In: International Conference on Offshore Mechanics and Arctic Engineering, San Diego, California, USA, 10-15 June 2007.

Fraga, C.T.C., Borges, F.A., Bellot, C., Beltrao, R. and Assayag, M.I. (2003). Campos Basin- 25 Years of Production and its Contribution to the Oil Industry. In: Offshore Technology Conference, Houston, USA, 5-8 May 2003. Petrobras S.A.

Gosh, R., Gioielli, P. and Kan,W. (2012). Design Considerations for HP/HT Steel Catenary Risers. ExxonMobil Development Co. Taken from <<<http://www.offshore-mag.com/articles/print/volume-72/issue-5/productions-operations/design-considerations-for-hp-ht-steel-catenary-risers.html>>>. [Accessed on 03 March 2014].

Gisvold, K.M. (2006). The History of FPSO's. Det Norske, Norway.

Gloaguen, M., Bourdillon, H., Roche, F., Reals, T.B., Menier, P. and Marion, A. (2007). Dalia Flowlines, Risers and Umbilicals. In: Offshore Technology Conference, Houston, USA, 30 April-3 May 2007. Total E&P Angola and Technip.

Gueveneux, H. (2010). AKPO Project: The successful Implementation of Steel Catenary Risers. In: Offshore Technology Conference, Houston, USA, 3-6 May 2010. Total S.A.

Hatton, S.A. (1999). Update on the Design of Steel Catenary Riser Systems. In: Deep and Ultra Deepwater Offshore Technology, Newcastle, England, 25-26 March 1999. 2H Offshore Engineering Limited.

Hoffman, J., Yun, H., Modi, A. and Pearce, R. (2010). Parques das Conchas (BC-10) Pipeline, Flowline and Riser System Design, Installation and Challenges. In: Offshore Technology Conference, Houston, USA, 3-6 May 2010. Shell International E&P Inc. and Nomad Consulting.

Howells, H. (1995). Advances in Steel Catenary Riser Design. In: DEEPTEC, Aberdeen, Scotland, February 1995. 2H Offshore Engineering Limited.

Howells, H and Hatton, S.A. (1997). Challenges for Ultra Deepwater Riser Systems. In: Floating Production Systems, IIR, London, April 1997. 2H Offshore Engineering Limited.

Journée, J.M.J. and W.W. Massie (2001). Introduction in Offshore Hydromechanics (OT3600). Delft, Netherland: Delft University of Technology.

Hutchinson Catalogue, 2010. Taken from << <http://oil-gas.hutchinsonworldwide.com/products/scr-flexible-joints>>>. [Accessed on 24 March 2014].

Karunakaran, D. and Baarholm, R. (2013). COBRA: An Uncoupled Riser System for Ultra Deep Water in Harsh Environments. In: Offshore Technology Conference, Houston, USA, 6-9 May 2013. Statoil and Subsea 7.

Karunakaran, D., Meiling, T.S., Kristoffersen, S. And Lund, K.M. (2005). Weight Optimized SCRs for Deepwater Harsh Environments. In: Offshore Technology Conference, Houston, USA, 2-5 May 2005. Statoil and Subsea 7.

Karunakaran, D., Nordsve, N.T., Olufsen, A. (1996). An Efficient Metal Riser Configuration for Ship and Semi Based Production Systems. In: International Offshore and Polar Engineering Conference, Los Angeles, USA, 26-31 May 1996. Trondheim Statoil research Center.

Karunakaran, D., Lee, D., Hatton, S., Dale, N. Mair, J. (2007). Grouped SLOR Deep Water System and Installation Assessment. In: Deepwater Offshore Technology Conference – Stavanger, Norway, 10-12 October 2007. Subsea7 and 2H Offshore Engineering Ltd.

Karunakaran, D., Clausen, T., Baxter, C. and Dret, S. (2004). Titanium Risers for a Semi-Sub. Subsea 7 and RTI. Taken from <<http://www.epmag.com/EP-Magazine/archive/Titanium-risers-a-semisubmersible_2642>>. [Accessed on 05 May 2014].

Karunakaran, D. (2013). Pipeline and Riser Technology Lecture Notes, University of Stavanger, Norway.

Kopp. F., Light, B.D., Preli, T.A., Rao, V.S. and Stingl, K.H. (2007). Design and Installation of the Na Kika Export Pipelines, Flowlines and Risers. In: Offshore Technology Conference, Houston, USA, 3-5 May 2004. Shell International E&P.

Kalman, M., Neto, T.B. and Yu, L. (2013). Recommended Practice for Unbonded Flexible Pipe Employing Composite Armour Material. In: Offshore Technology Conference-Brazil, Rio de Janeiro, Brazil, 29-31 October 2013. DeepFlex.

Legras, J.L. (2013). Tethered Catenary Riser: A Novel Concept for Ultra-Deepwater. In: Offshore Technology Conference, Houston, USA, 6-9 May 2013. Subsea 7.

Luffrum, S. and Lim, F. (2005). Gas Lift Using COR. 2H Offshore Engineering Limited.

Lupi, A., Cousin, G. and Sullivan, R.O. (2014). Deepwater Hybrid Riser Systems. In: Offshore Technology Conference - Asia, Kuala Lumpur, Malaysia, 25-28 March 2014. SEAL Engineering and Technip Oceania Pty Ltd.

Maclure, D. and Walters, D. (2010). Freestanding Risers in the Gulf of Mexico-A Unique Solution for Challenging Field Development Configuration. In: Offshore Pipeline Technology Conference, Amsterdam, Netherlands, 8-9 March 2006. 2H Offshore Engineering Limited.

Marcoux, J.S. and Legras, J.L. (2011). Lessons Learned on the Design and Construction of Hybrid Riser Towers. In: Offshore Technology Conference, Houston, USA, 2-5 May 2011. Acergy.

Marcoux, J.S. and Legras, J.L. (2014). Impact on Risers and Flowlines Design of the FPSO Mooring in Deepwater and Ultra Deepwater. In: Offshore Technology Conference, Houston, USA, 5-8 May 2014. Subsea 7.

Marintek Report. (2005). VIVANA - Theory Manual Version 3.4. Trondheim, Norway: Norwegian Marine Technology Research Institute (MARINTEK).

Martins, M.A.L., Lages, E.N. and Silveira, E.S.S. (2012). Deepwater Complaint Vertical Access Riser Response Optimization. In: International Journal of Modeling and Simulation for Petroleum Industry, Volume 6, Number 2, September 2012. Federal University of Alagoas, Brazil.

Neto, E., Mauricio, J. and Waclawek, L. (2001). Flexible Pipe for Ultra-Deepwater Applications: The Rancodar Experience. In: Offshore Technology Conference, Houston, USA, 30 April-3 May 2001. Petrobras S.A and CSO Brazil.

Nielsen, K.G., Bendiksen, E., Belfroid, S. and Korst, H. (2011). Application of a New Wire Carcass Design for Prevention of Singing Behavior in Flexible Risers. In: Offshore Technology Conference, Houston, USA, 2-5 May 2011. NKT Flexibles and TNO Science & Industry.

NKT Flexible Brochure, 2012. Taken from <<<http://pdf.directindustry.com/pdf/nkt-cables-17613.html>>>. [Accessed on 22 February, 2014].

NORSOK D-001. Global Standard for Drilling Facilities, Revision 3, December 2012, Oslo, Norway. Norwegian Technology Standards Institution.

Orcina Ltd. (2010). Orcaflex Manual. Cumbria, UK. Orcina Ltd.

Palmer, A.C. and King, R.A. (2004) Subsea Pipeline Engineering. US: Penwell Corporation.

Phifer, E.H., Kopp, F., Swanson, R.C., Allen, D.W. and Langner, C.G. (1994). Design and Installation of Auger Steel Catenary Risers. In: Offshore Technology Conference, Houston, USA, 2-5 May 1994. Shell Development Co.

Rouillon, J. (2002). Girassol–The Umbilicals and Flowlines – Presentation and Challenges. In: Offshore Technology Conference, Houston, USA, 6-9 May 2002. TotalFinaElf.

Royer, B.S., Power, T.L and Head, W. (2013). Riser Concepts for High Motion Vessels in Ultra Deep Water. In: Offshore Technology Conference, Houston, USA, 6-9 May 2013. Stress Engineering Services Inc. and RPSEA.

Saipem Brochure, 2013. Taken from <<<http://www.saipem.com/site/home/documentation/brochure/general-brochures-and-presentations.html>>>. [Accessed on 9 April 2014].

Salies, J.B. (2003). PROCAP-3000: New Challenges for 3000m Water Depth. In: International Conference on Offshore Mechanics and Arctic Engineering, Cancun, Mexico, 8-13 June 2003. Petrobras S.A.

Sas, E. Pere, J.M, Pierre, S. and Omar, A. (2008). Flexible Pipe Design Optimization for West of Africa Deepwater: Agbami Production Riser Case Study. In: Offshore Technology Conference, Houston, USA, 5-8 May 2008. Chevron and Technip.

Serta, O.B., Mourelle, M.M., Grealish, F.W., Harbert, S.J. and Souza, L.F.A. (1996). Steel Riser Catenary Riser for the Marlim Field FPS P-XVIII. In: Offshore Technology Conference, Houston, USA, 6-9 May 1996. Petrobras, MCS International and Oil States.

Smith, N.S. (2013). Subsea 7 Riser Technology. Taken from: <http://www.subsea7.com/files/docs/Datasheets/Technology/4_Pg_Leaflet_Riser_Technology_Reference.pdf> [Accessed on 14 April 2014].

Skeie, G., Sødahl, N. and Steinkjer, O. (2012). Efficient Fatigue Analysis of Helix Elements in Umbilicals and Flexible Risers: Theory and Applications. In: Journal of Applied Mathematics Volume 2012, Article ID 246812, Accepted 11 April 2012. DNV, Norway.

Sparks, C.P. (2007). Fundamentals of Marine Riser Mechanics. US: Penwell Corporation.

Sworn, A. (2005). Hybrid Riser Towers from an Operator's Perspective. In: Offshore Technology Conference, Houston, USA, 2-5 May 2005. BP Exploration Operating Co.

Technip Brochure, 2013. Taken from <<http://www.technip.com/sites/default/files/technip/page/attachments/flexible_pipe_brochure.pdf>>. [Accessed on 21 February 2014].

Tellier, E. and Theti, R. (2009). The Evolution of Freestanding Risers. In: International Conference on Ocean, Offshore and Arctic Engineering, Honolulu, Hawaii, USA, 31 May-5 June 2009. 2H Offshore Engineering Ltd.

Tillinghast, W.S., Shah, B.C. and Sturdevant, L.A. (1987). Laying Flexible Pipelines Over Coral Reefs in the Geisum Field, Gulf of Suez, Egypt. In: Offshore Technology Conference, Houston, USA, April 1987. Conoco Inc. Crest Engineering Services and Coflexip Inc.

Trelleborg Brochure, 2013. Taken from <<<http://www.trelleborg.com/en/offshore/Products-and-Solutions/Subsea/>>>. [Accessed on 26 February 2014].

Uppu, K. (2012). Assessment of Riser System Selection. In: Deepwater Technology Asia, Jakarta, Indonesia, 19-20 March 2012. Genesis Oil and Gas, Houston.

4Subsea (2013). Unbonded Flexible Risers-Recent Field Experience and Actions for Increased Robustness. Revision 5 for PSA Norway.

10.2 Internet Reference

BMP, 2013. Bend Restrictor Picture. Taken from <<<http://www.subseacableprotection.com/products/bend-restrictors.cfm>>>. [Accessed on 26 February 2014].

E&P Magazine, December 2011. Forecast of FPU's. Taken from <<http://www.epmag.com/item/Offshore-Tide-The-Rise_92764>>. [Accessed on 26 January 2014].

Offshore Energy Today, February 2012. Taken from <<<http://www.offshoreenergytoday.com/norway-statoil-orders-subsea-structures-for-asgard/>>>. [Accessed on 26 February 2014].

Offshore Magazine, November 2010. Deepwater Production Riser Systems and Components. Taken from <<<http://www.offshore-mag.com/maps-posters.html>>> [Accessed on 03 March 2014].

Offshore Magazine, January 2012. Riser Options for FPSOs. Taken from <<<http://www.offshore-mag.com/articles/print/volume-72/issue-4/productions-operations/study-examines-mooring-and-riser-options-for-fpsos.html>>> [Accessed on 25 January 2014].

Offshore Magazine, May 2013. FPU Types. Taken from <<<http://www.offshore-mag.com/articles/print/volume-62/issue-10/news/state-of-the-art-of-spread-moored-systems-for-deepwater-floating-production-platforms.html>>>. [Accessed on 09 January 2014].

Offshore Magazine, August 2013. Worldwide Survey of FPSO Units. Taken from <<<http://www.offshore-mag.com/maps-posters.html>>> [Accessed on 15 January 2014].

Offshore Technology, 2008. FPU data. Taken from <<<http://www.offshore-technology.com/features/feature40937/>>>. [Accessed on 09 January 2014].

Oil and Gas Journal, 2010. FPU percentage distribution. Taken from <<<http://www.ogj.com/articles/2010/11/floating-production.html>>>. [Accessed on 22 January 2014].

SOFEC, 2013. FPSO Turret Types. As retrieved from <<<http://www.sofec.com/productsbySubInfo.asp?intcategoryName=Mooring%20Systems&intsubCat=External%20Turret>>>. [Accessed on 02 February 2014].

APPENDIX A – Worldwide Deepwater FPSO Riser Concept

Tabell 0.1 presents a review of riser concepts which has been installed worldwide with FPSOs in deepwater till now. CLOV FPSO which will be stationed in Block 17 Angola will use 2 HRTs and 1SHR and has not been included in the list as the project is still under development and first oil is expected in mid-2014.

FPSO Name	Field Name	Water Depth (m)	Mooring System	Riser Concept	Start Year	Country
BRAZIL						
Fluminense	Bijupira	740	ET	Flexible Riser Catenary	08.2003	Brazil
P-33	Marlim	780	IT	Flexible Riser Catenary	2002	Brazil
P-43	Barracuda	790	DICAS	Flexible Riser Catenary	12.2004	Brazil
P-35	Marlim	850	IT	Flexible Riser Catenary	08.1999	Brazil
P-37	Marlim	905	IT	Flexible Riser Catenary	07.2000	Brazil
MarlimSul	MarlimSul	1200	IT	Flexible Riser Catenary	02.2005	Brazil
P-48	Caratinga	1040	DICAS	Flexible Riser Catenary	06.2009	Brazil
FRADE	Frade BC4	1080	IT	Flexible Riser Catenary	12.2008	Brazil
P-53	Marlim Leste	1080	IT	Flexible Riser Catenary	11.2013	Brazil
P-63	Papa Terra	1200	SM	IPB-Flexible Riser Catenary	06.2004	Brazil
Cidade Deanchieta	Baleia Azul	1221	IT	Flexible Riser Catenary	09.2012	Brazil
P-50	Albacora Leste	1225	DICAS	Flexible Riser Catenary	04.2006	Brazil
P-57	Jubarte Phase 2	1260	SM	Flexible Riser Catenary	12.2010	Brazil
P-34	Jubarte	1350	IT	Flexible Riser Catenary	12.2005	Brazil
Cidade Rio De Janeiro	Espadarte	1350	SM	Flexible Riser Catenary	01.2007	Brazil
Brasil	Roncador	1360	IT	Flexible Riser Catenary	12.2002	Brazil
P-54	Roncador Module 2	1400	DICAS	Flexible Riser Catenary	12.2007	Brazil
P-58	Parque das Baleias	1400	SM	Flexible Riser Catenary	03.2014	Brazil
Capixaba	Cachalote	1485	IT	Flexible Riser Catenary	06.2010	Brazil
Espirito Santo	BC-10	1780	IT	Steel lazy Wave Riser-SLWR	07.2009	Brazil
Cidade De Sao Paulo	Sapinhoa	2100	SM	Buoyancy Supported Riser	01.2013	Brazil
Cidade De Paraty	Lula NE	2120	SM	Buoyancy Supported Riser	06.2013	Brazil
BW Cidade De Sao Vicente	Early Production from Various Fields	2120	ET	Flexible Riser Catenary	04.2009	Brazil
CidadeDe Angra dos MV22	Lula (Tupi)	2150	SM	Lazy Wave Flexible Riser	10.2010	Brazil

FPSO Name	Field Name	Water Depth (m)	Mooring System	Riser Concept	Start Year	Country
AFRICA						
Gimboa	Gimboa	711	SM	Flexible Riser Catenary	04.2009	Angola
SaxiBatuque	Saxi Batuque	720	ET	Flexible Riser Catenary	07.2008	Angola
Mondo	Mondo	728	ET	Flexible Riser Catenary	01.2008	Angola
Pazflor	Block 17- Acacia,	780	SM	IPB-Flexible Riser Lazy Wave	08.2011	Angola
Usan	Usan OML 138	850	SM	Single Hybrid Riser	02.2012	Nigeria
Aseng	Aseng	960	IT	Flexible Riser Catenary	11.2011	EqGuinea
Baobab IvoirienMV10	Boabab	970	ET	Flexible Riser Catenary	08.2005	Cote d'Ivoire
Bonga	Bonga	1000	SM	Steel Catenary Riser	11.2005	Nigeria
Kizomba B	Block15- Kissanje, Dikanza	1016	SM	Single Hybrid Riser	07.2005	Angola
Kwame Nkrumah	Tano basin	1100	ET	Flexible Riser Pliant Wave	11.2010	Ghana
Erha	Niger delta OPL 209	1180	SM	Steel Catenary Riser	04.2006	Nigeria
Kizomba A	Block 15- Hungo, Cocalho	1180	SM	Single Hybrid Riser	08.2004	Angola
Greater Plutonio	Block18- Paladio, Plutonio	1200	SM	Hybrid Riser Tower	10.2007	Angola
AKPO	Akpo OPL 246, OML-130	1350	SM	Steel Catenary Riser	03.2009	Nigeria
Dalia	Dalia Block 17	1360	SM	IPB-Flexible Riser Catenary	12.2006	Angola
Girassol & Rosa	Girassol Jasmim Block17	1400	SM	Hybrid Riser Tower	12.2001	Angola
Agbami	Agbami OPL216, 217	1462	SM	Flexible Riser Catenary	07.2008	Nigeria
PSVM	Block 31- Plutao,	2000	ET	Single Hybrid Riser	12.2012	Angola
REST OF THE WORLD						
Berge Helene	Chinguetti Field	800	ET	Flexible Riser Lazy Wave	02.2006	Mauritania
Staybarrow Venture	Staybarrow	825	IT	Flexible Riser Lazy Wave	11.2007	Western Australia
Firenze	Aquila	850	ET	Flexible Riser Catenary	2012	Italy
Dhirubhai-1	MA-D6	1200	IT	Flexible Riser Pliant Wave	09.2008	India
Kikeh	Kikeh	1350	ET	Flexible Riser Lazy wave	08.2007	Malaysia
BW Pioneer	Cascade and Chinook	2500	IT	Single Hybrid Riser	02.2012	US GoM

Tabell 0.1 - Worldwide Riser Concepts with Deepwater FPSO [Offshore Magazine, August 2013]

APPENDIX B – Wave Spectrum Models & Cost Details

WAVE SPECTRUM MODELS

P-M Model:

It is one parameter model and while deriving this model Pierson and Moskowitz (1964) assumed steady flow of wind over large area (about 5000 wavelengths) and for long time (about 10000 wave periods) which would result an equilibrium condition with the waves. This is the concept of a fully developed sea and it is generally used in North Atlantic seas as it was derived from the data taken from North Atlantic.

According to DNV (October 2010), The Pierson-Moskowitz (PM) spectrum $S_{PM}(\omega)$ is given by:

$$S_{PM}(\omega) = \frac{5}{16} \cdot H_s^2 \omega_p^4 \cdot \omega^{-5} \exp\left(-\frac{5}{4} \left(\frac{\omega}{\omega_p}\right)^{-4}\right)$$

Where $\omega_p = 2\pi/T_p$ is the angular spectral frequency.

JONSWAP Model:

The JONSWAP (Joint North Sea Wave Project) spectrum is often used to describe coastal waters where the fetch is limited. Figure A1 shows JONSWAP spectrum with 3 different gamma values.

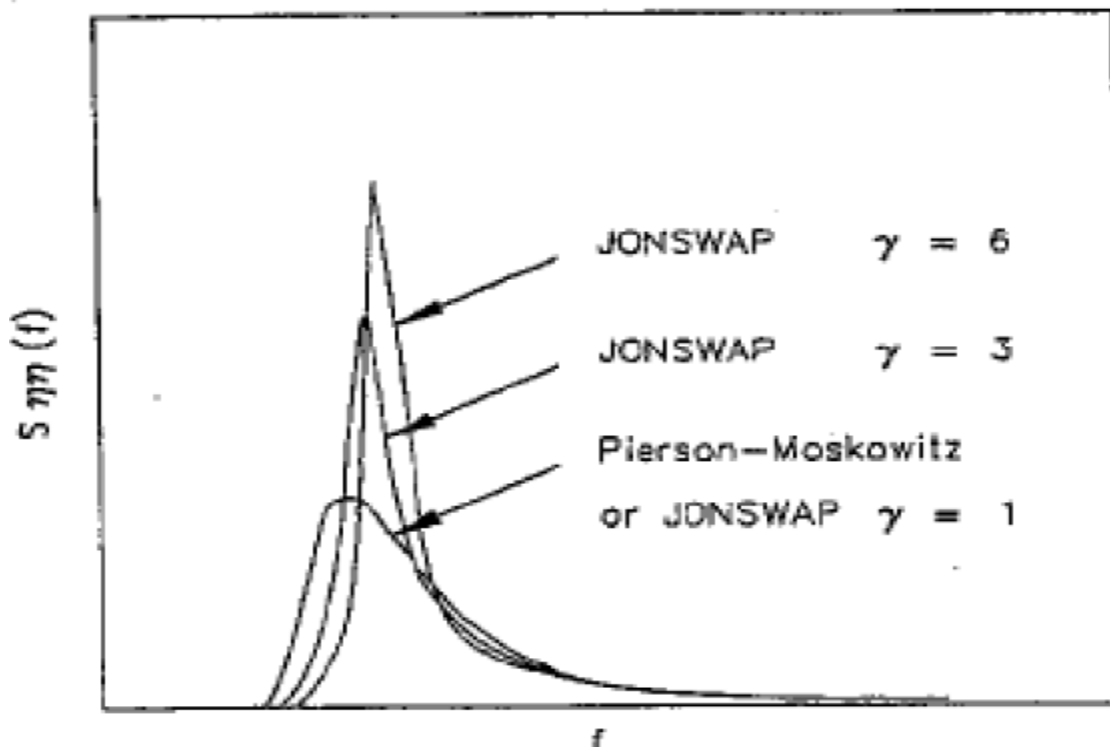

Figure A1 - JONSWAP Spectrum with 3 different Gamma Values

The governing equation for JONSWAP spectrum is given as:

$$S(\omega) = \alpha \cdot g^2 \cdot \omega^{-5} \cdot \exp(-1.25(\omega/\omega_p)^{-4}) \cdot \gamma^{-(\omega - \omega_p)^2 / 2\sigma^2 \omega_p^2}$$

Where:

- ω Angular wave frequency = $2\pi T\omega$
- $T\omega$ Wave period
- Tp Peak wave period
- Tz Zero up-crossing wave period $\rightarrow Tp/Tz = 1.407(1 - 0.287 \ln \gamma)^{1/4}$
- ωp Angular spectral peak frequency = $2\pi/Tp$
- g Acceleration due to gravity
- α $5.058(1 - 0.287 \ln \gamma) Hs^2 / Tp^4$
- σ Spectral width parameter
 = 0.07 for $\omega \leq \omega p$
 = 0.09 for $\omega \geq \omega p$
- γ Peakedness parameter
 = 1.0 for $Tp \geq 5\sqrt{Hs}$
 = $e(5.75 - 1.15Tp/\sqrt{Hs})$ for $3.6\sqrt{Hs} \leq Tp < 5\sqrt{Hs}$
 = 5.0 for $Tp < 3.6\sqrt{Hs}$

This spectrum describes sea under development as well as fully developed sea.

Ochi - Hubble Spectrum:

It is a 6 parameter spectrum which describes combination of 2 superimposed seas i.e. swell and locally generated sea. This spectrum was derived from analysis of some 800 spectra measure in the North Atlantic and is shown in figure A2.

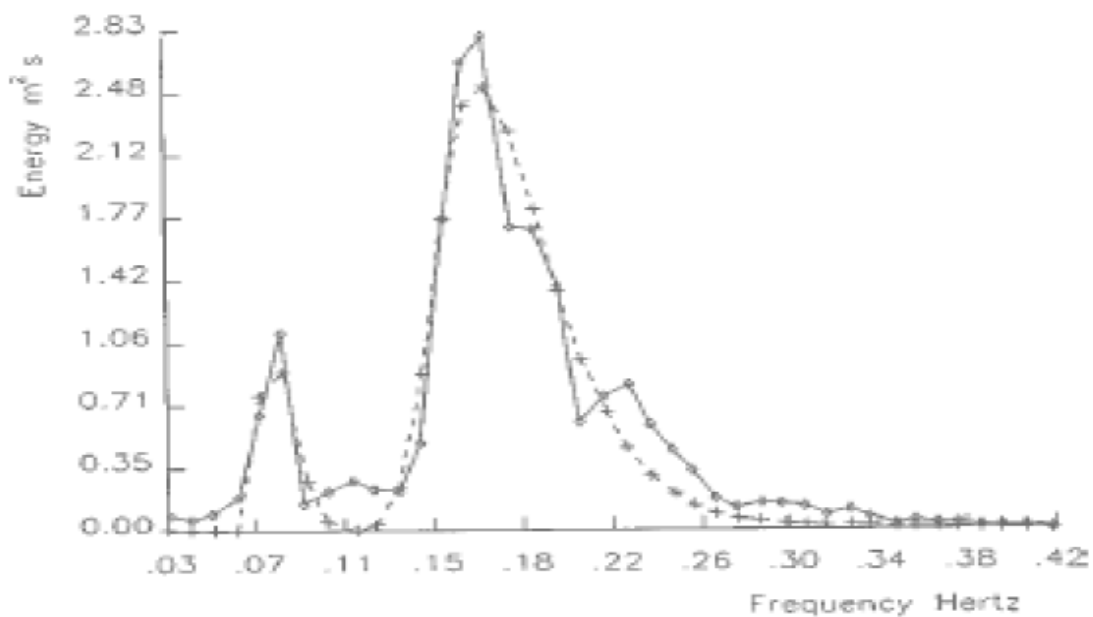

Figure A2 – Sample Fitting of Bimodal Spectrum Using Ochi’s Six Parameter Formula

This spectrum provides a better method to represent all stages of development of a sea in a storm. The general formula is:

$$S(\omega) = \frac{1}{4} \sum_{j=1}^2 \frac{\left(\frac{4\lambda_j + 1}{4} \omega_{0j}^4\right)^{\lambda_j}}{\Gamma(\lambda_j)} \times \frac{H_{sj}^2}{\omega^{4\lambda_j+1}} \exp\left[-\left(\frac{4\lambda_j + 1}{4}\right)\left[\omega/\omega_{0j}\right]^{-4}\right]$$

The swell is wave which has travelled a large distance and is characterized by small wave height and large time period. The parameters which define the waves are given by significant wave height, peak frequency and peakedness parameter.

SLWR COST DETAILS

Fabrication Cost Details:

Cost of Steel Pipe + Insulation + Welding = 15000 NOK/m [given by EMAS AMC AS]

So cost of 3000m of pipe = 15000 * 3000 = 45 million NOK

Cost of 1 Buoyancy Module = 114000 NOK [given by EMAS AMC AS]

Total Number of Buoyancy Modules Used = 42 (calculated from design done in case study)

So cost of 42 Buoyancy Modules = 4.8 million NOK

Cost of Flex Joint for the designed riser = 12 million NOK [given by Hutchinson Engineering Group]

Total Fabrication Cost for SLWR = 45 + 4.8 + 12 = 61.8 million NOK

Installation Cost Details:

Cost of IV for lazy wave flexible riser = 1.53 million NOK/day [given by EMAS AMC AS]

Time required for installation and hook up for 3000m lazy wave flexible riser = 1 day

Total Installation Cost for Lazy Wave Flexible Riser = 1.53 * 1 = 1.53 million NOK [given by EMAS AMC AS]

Cost of IV for SLWR = 2.45 million NOK/day [given by EMAS AMC AS]

Time required for installation and hook up for 3000m SLWR = 3 days [given by EMAS AMC AS]

Total Installation Cost for SLWR = 2.45 * 3 = 7.35 million NOK

APPENDIX C – Detailed Analysis Result

Static Analysis Result

Steel Lazy Wave Riser (SLWR)

Load Case 1: Effective Tension

OrcaFlex 9.7a: Nominal Position.sim (modified 17:06 on 28.04.2014 by OrcaFlex 9.7a)
Range Graph: SLWR Effective Tension, Static State

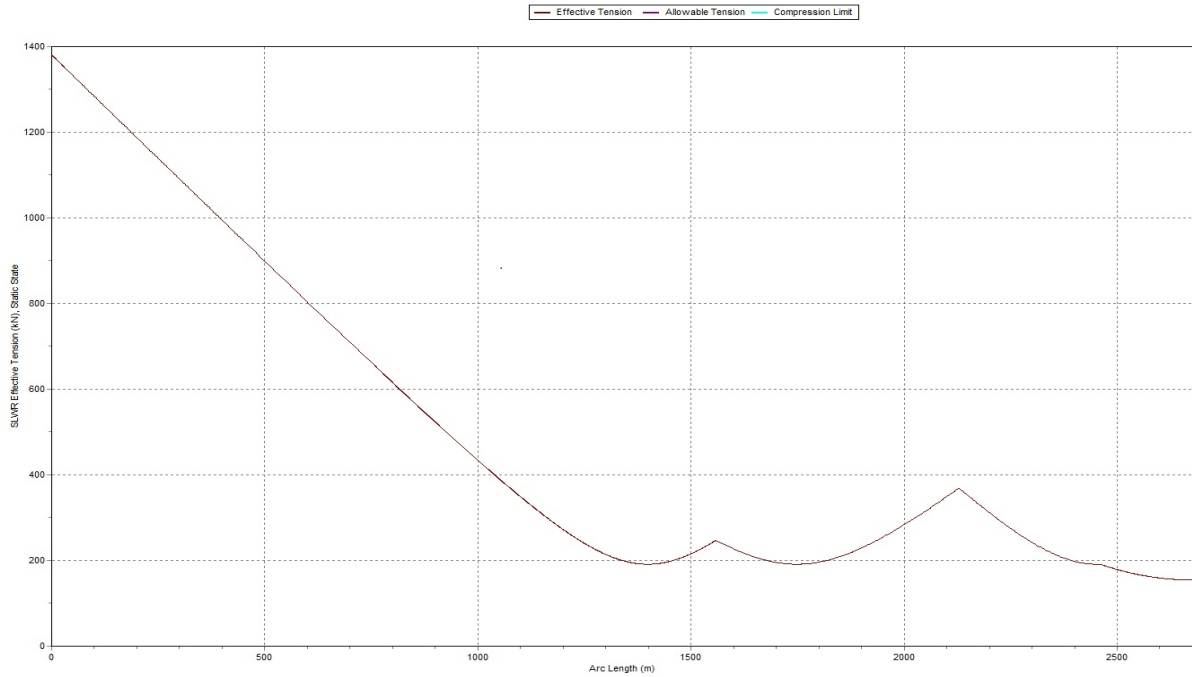

Load Case 1: Bend Moment

OrcaFlex 9.7a: Nominal Position.sim (modified 17:06 on 28.04.2014 by OrcaFlex 9.7a)
Range Graph: SLWR Bend Moment, Static State

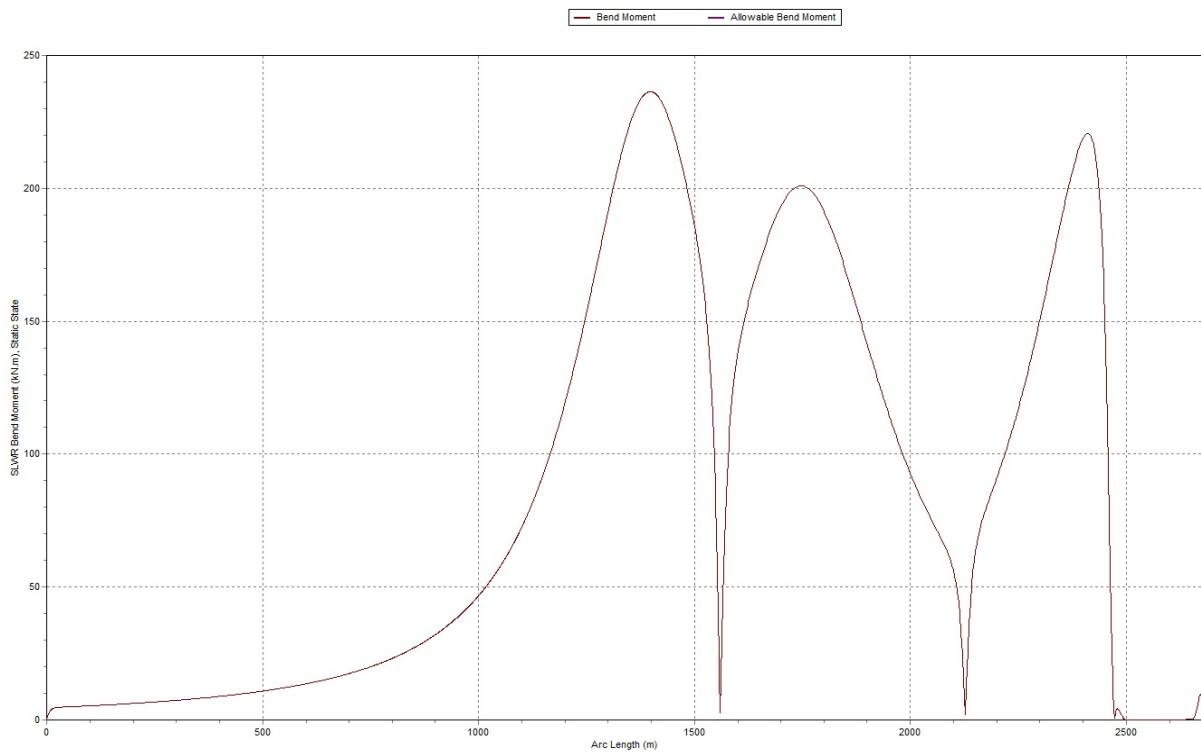

Load Case 2: Effective Tension

OrcaFlex 9.7a: Far Rigid-ULS.sim (modified 16:31 on 28.04.2014 by OrcaFlex 9.7a)
Range Graph: SLWR Effective Tension, Static State

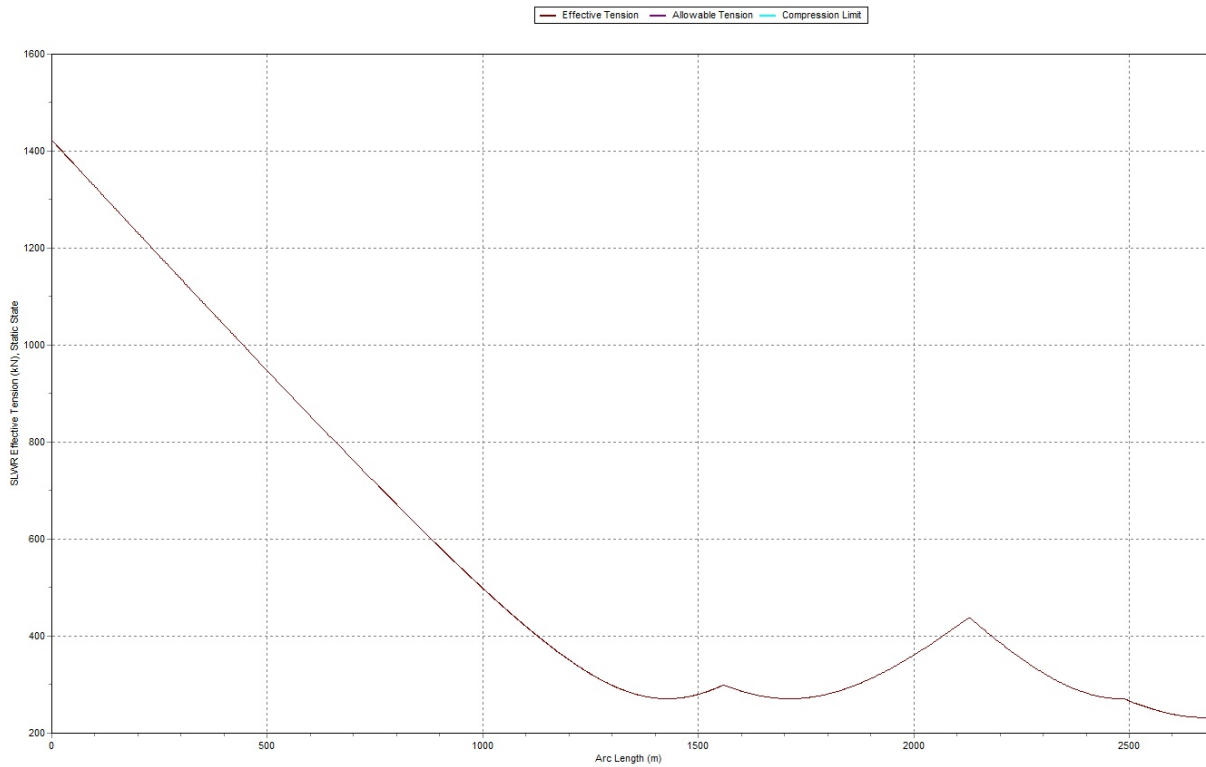

Load Case 2: Bend Moment

OrcaFlex 9.7a: Far Rigid-ULS.sim (modified 16:31 on 28.04.2014 by OrcaFlex 9.7a)
Range Graph: SLWR Bend Moment, Static State

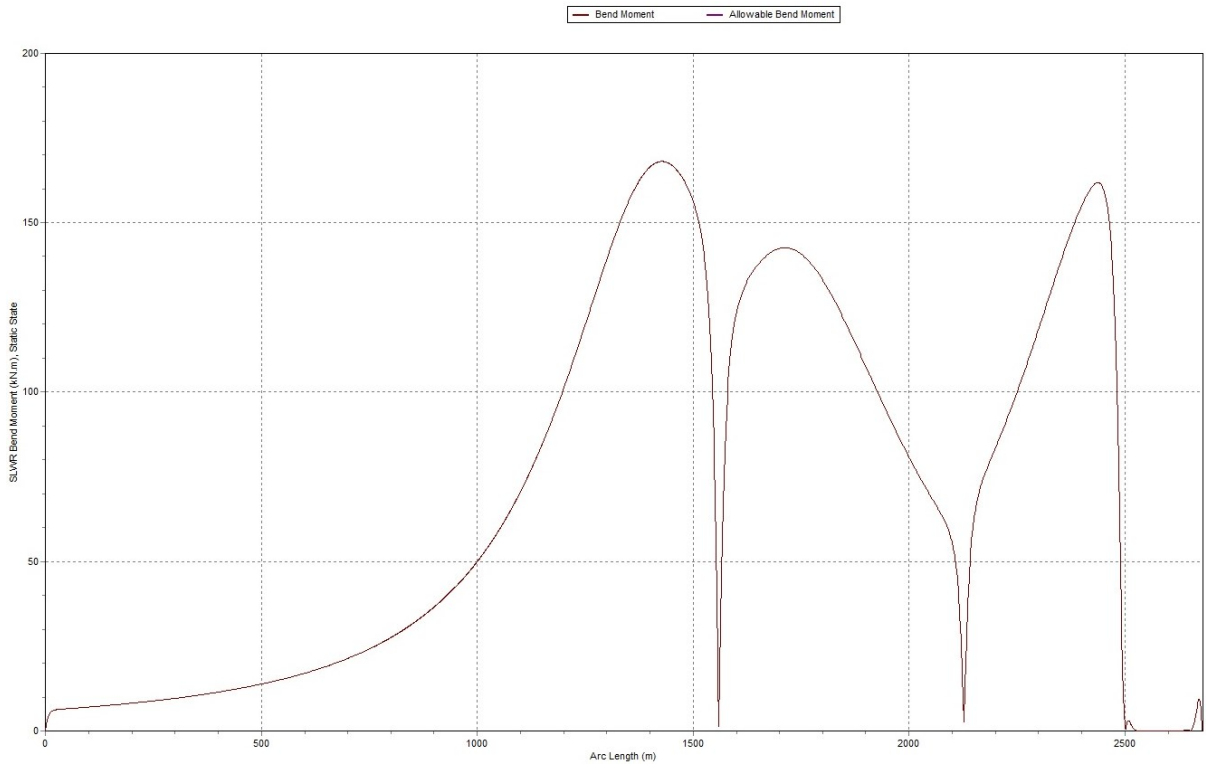

Load Case 3: Effective Tension

OrcaFlex 9.7a: Near Rigid-ULS sim (modified 15:07 on 28.04.2014 by OrcaFlex 9.7a)
Range Graph: SLWR Effective Tension, Static State

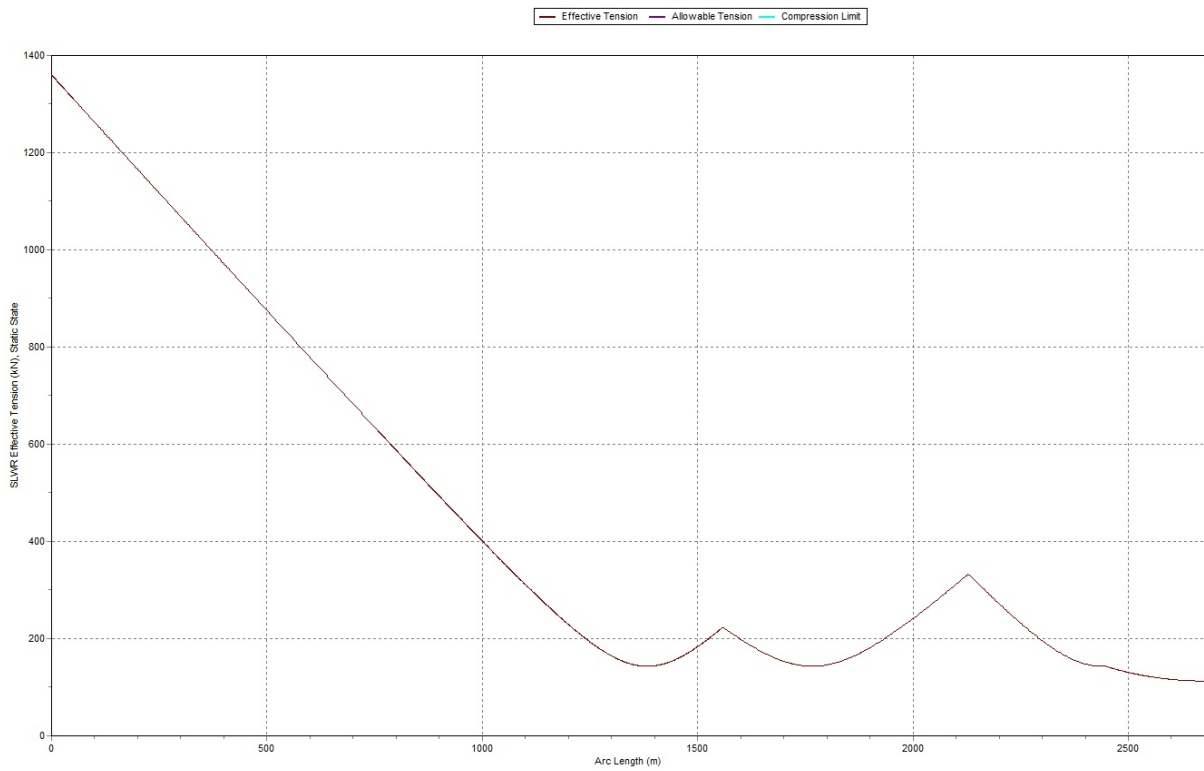

Load Case 3: Bend Moment

OrcaFlex 9.7a: Near Rigid-ULS sim (modified 15:07 on 28.04.2014 by OrcaFlex 9.7a)
Range Graph: SLWR Bend Moment, Static State

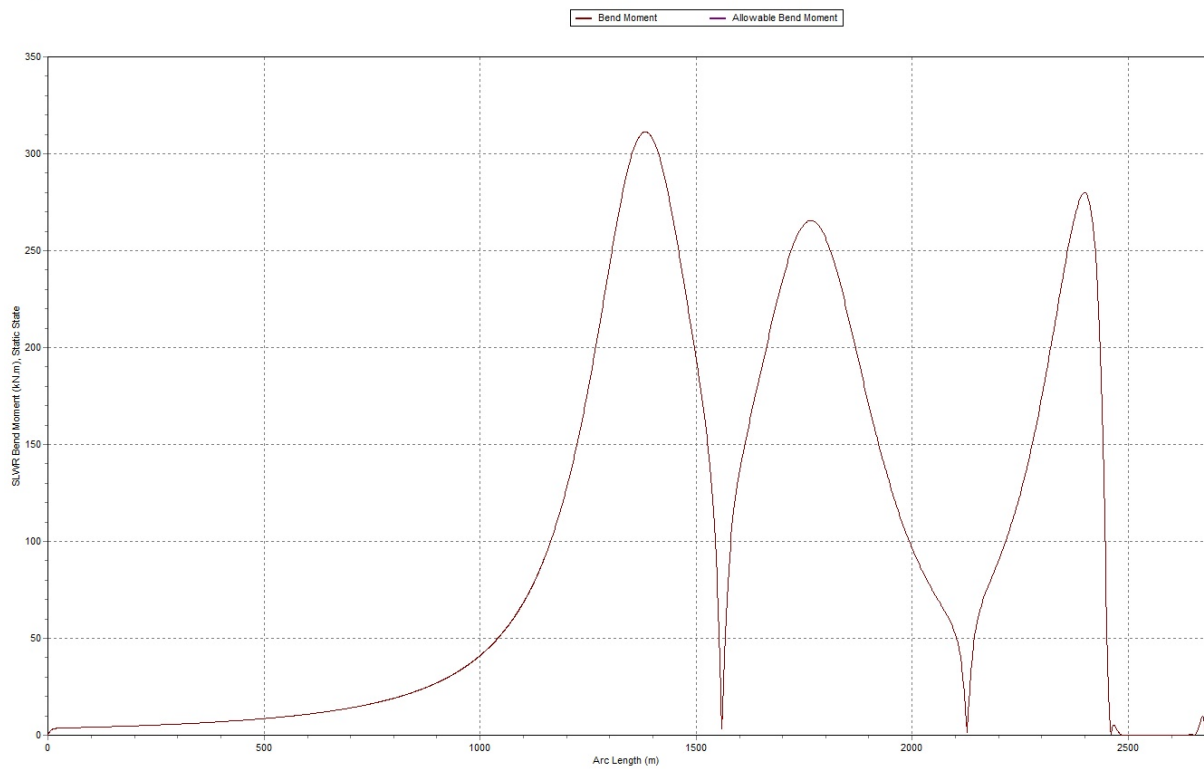

Load Case 4: Effective Tension

OrcaFlex 9.7a: Far Rigid-ALS.sim (modified 15:04 on 28.04.2014 by OrcaFlex 9.7a)
Range Graph: SLWR Effective Tension, Static State

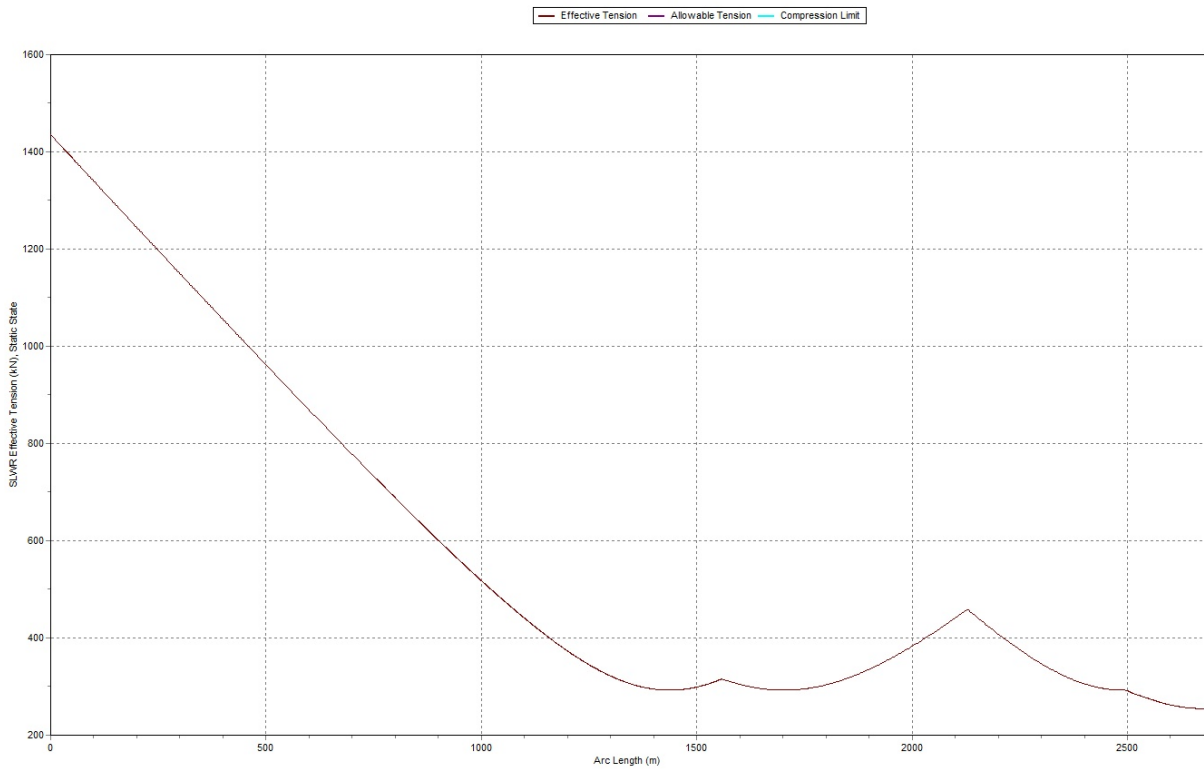

Load Case 4: Bend Moment

OrcaFlex 9.7a: Far Rigid-ALS.sim (modified 15:04 on 28.04.2014 by OrcaFlex 9.7a)
Range Graph: SLWR Bend Moment, Static State

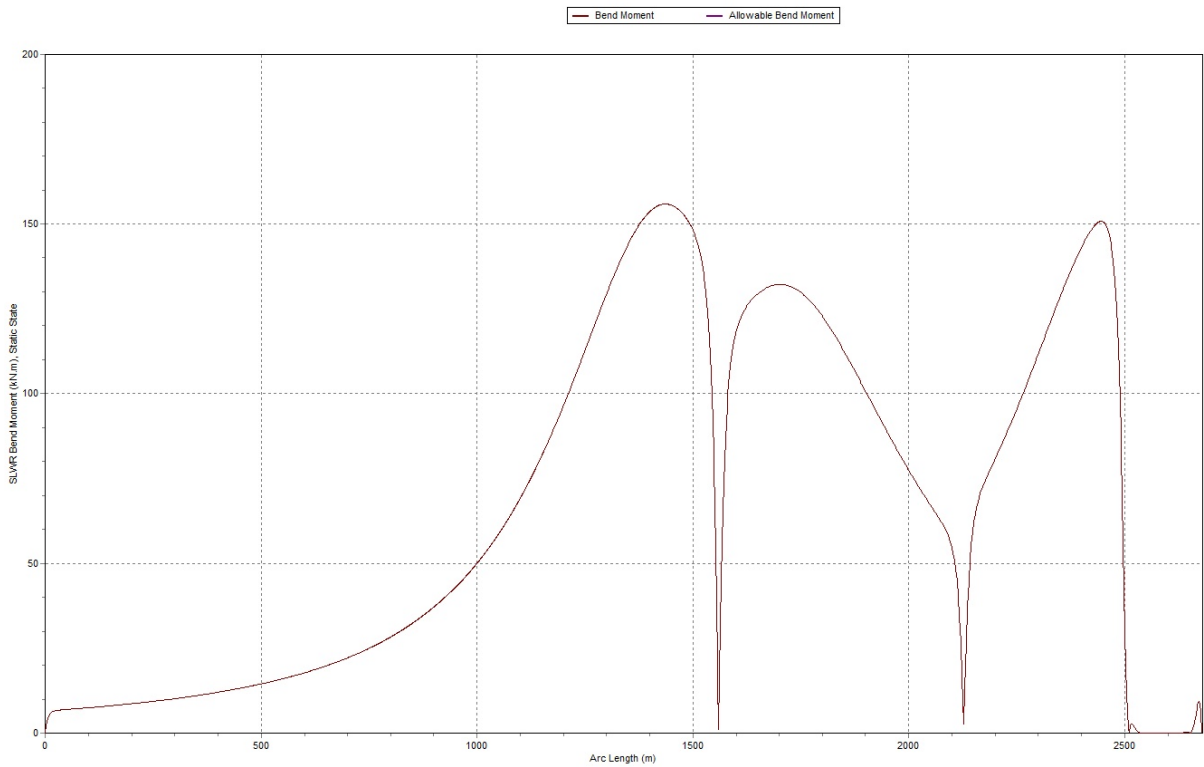

Load Case 5: Effective Tension

OrcaFlex 9.7a: Near Rigid-ALS sim (modified 15:03 on 28.04.2014 by OrcaFlex 9.7a)
Range Graph: SLWR Effective Tension, Static State

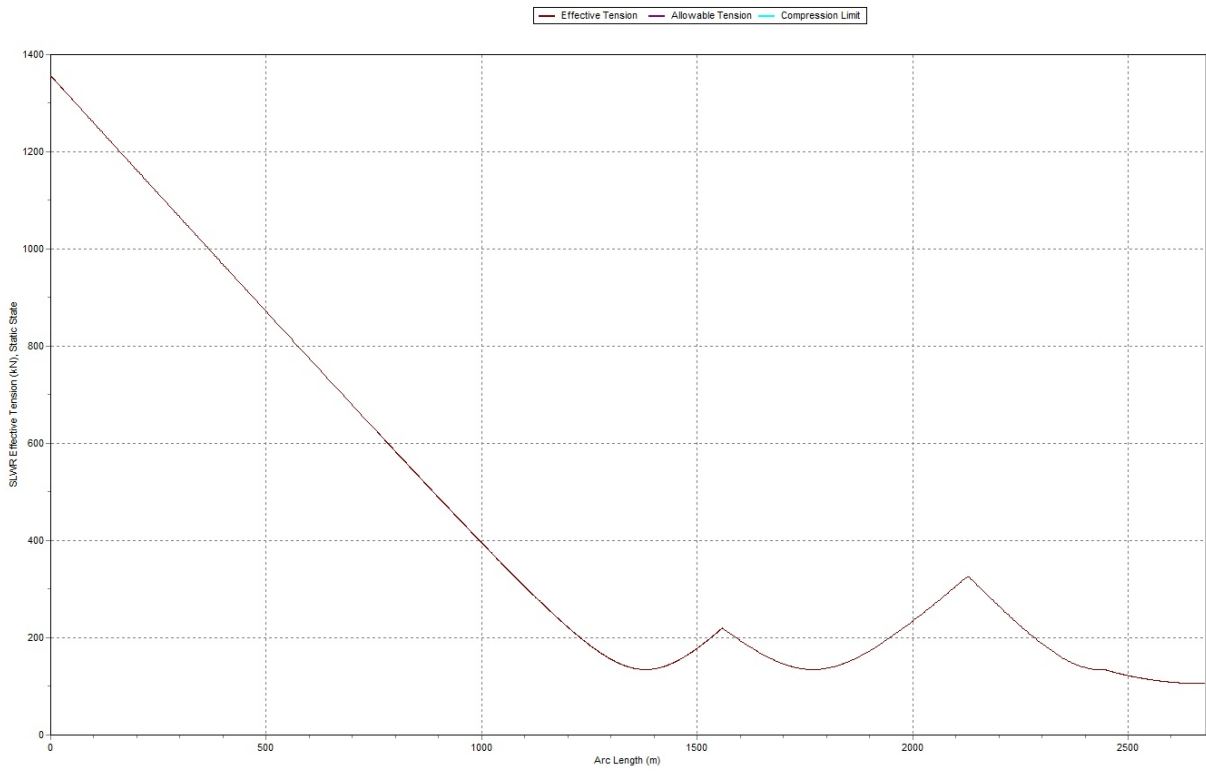

Load Case 5: Bend Moment

OrcaFlex 9.7a: Near Rigid-ALS sim (modified 15:03 on 28.04.2014 by OrcaFlex 9.7a)
Range Graph: SLWR Bend Moment, Static State

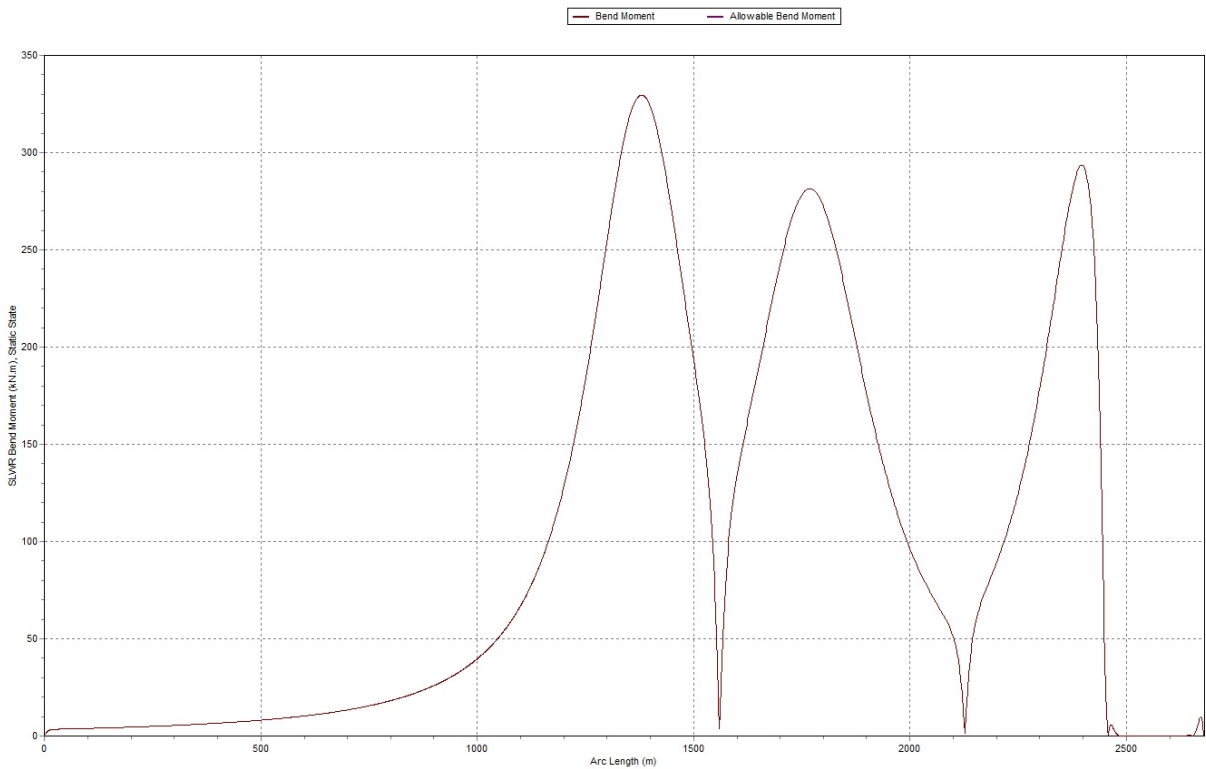

Lazy Wave Flexible Riser

Load Case 1: Effective Tension

OrcaFlex 9.7a: Nominal Flexible.sim (modified 15:04 on 28.04.2014 by OrcaFlex 9.7a)
Range Graph: Flexible Riser 10⁷ Effective Tension, Static State

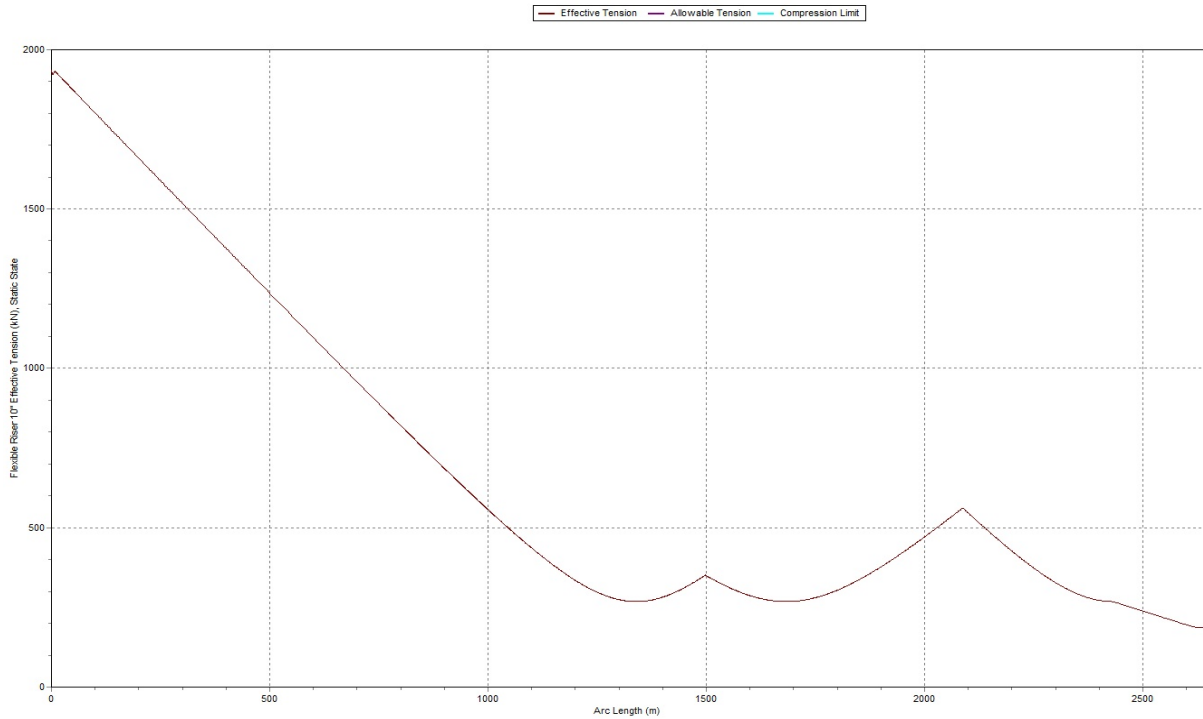

Load Case 1: Normalised Curvature

OrcaFlex 9.7a: Nominal Flexible.sim (modified 15:04 on 28.04.2014 by OrcaFlex 9.7a)
Range Graph: Flexible Riser 10⁷ Normalised Curvature, Static State

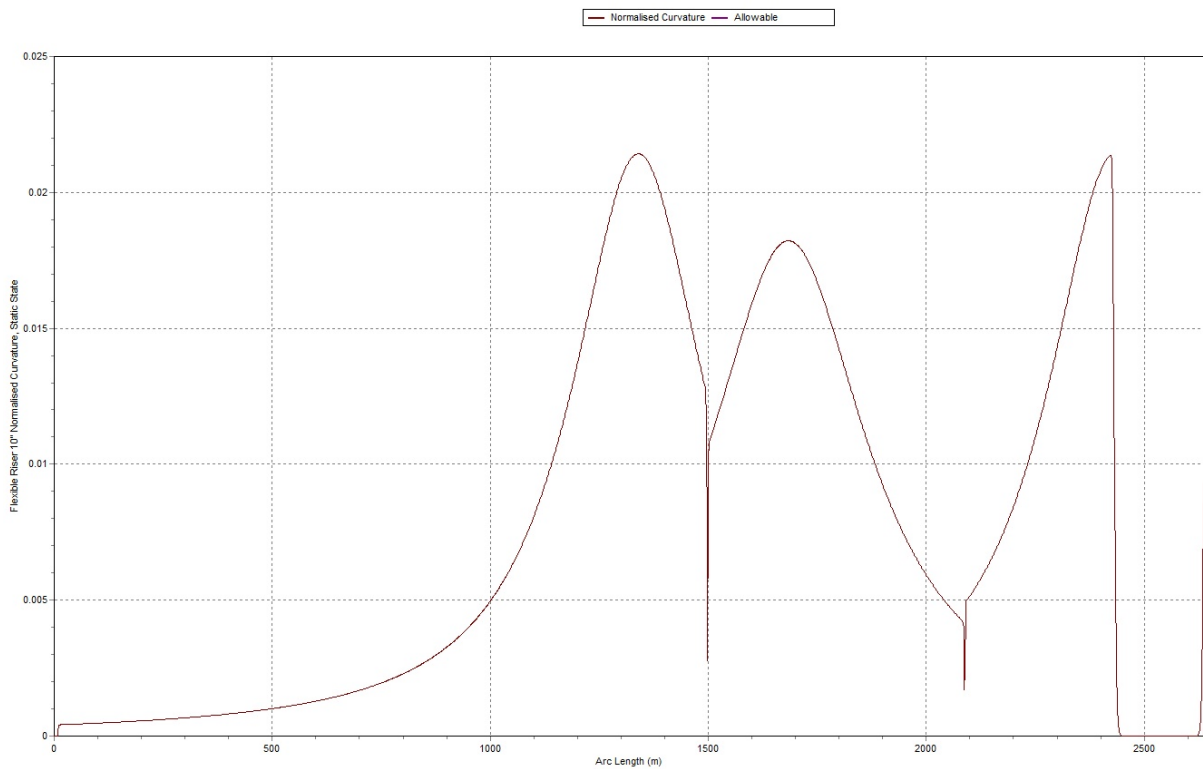

Load Case 2: Effective Tension

OrcaFlex 9.7a: Far Flexible-ULS.sim (modified 15.06 on 28.04.2014 by OrcaFlex 9.7a)
Range Graph: Flexible Riser 10° Effective Tension, Static State

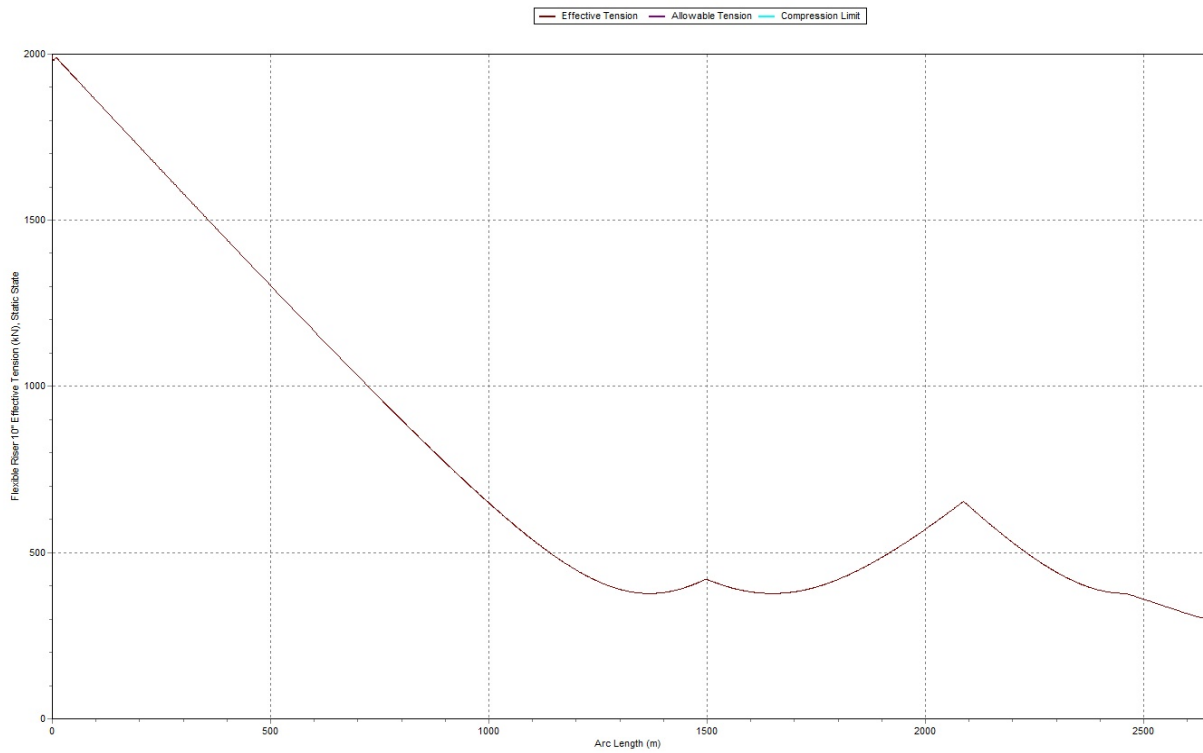

Load Case 2: Normalised Curvature

OrcaFlex 9.7a: Far Flexible-ULS.sim (modified 15.06 on 28.04.2014 by OrcaFlex 9.7a)
Range Graph: Flexible Riser 10° Normalised Curvature, Static State

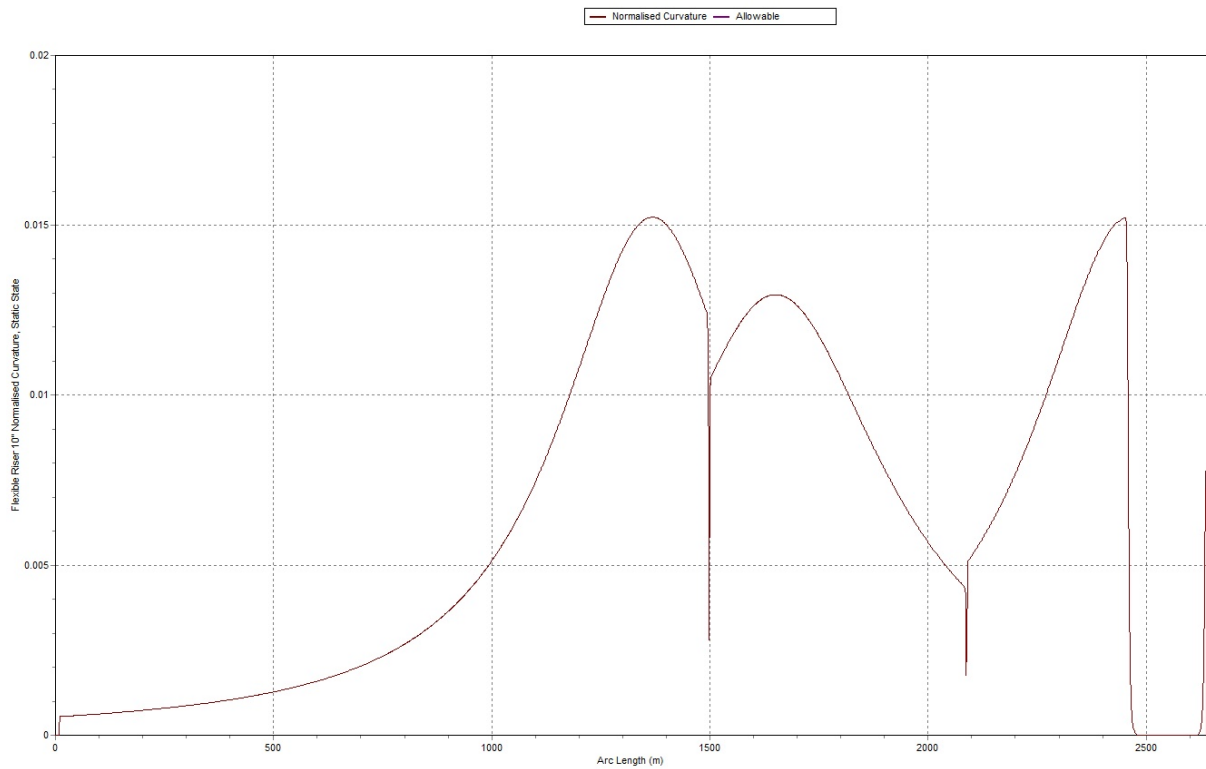

Load Case 3: Effective Tension

OrcaFlex 9.7a: Near Flexible-ULS sim (modified 15:05 on 28.04.2014 by OrcaFlex 9.7a)
Range Graph: Flexible Riser 10" Effective Tension, Static State

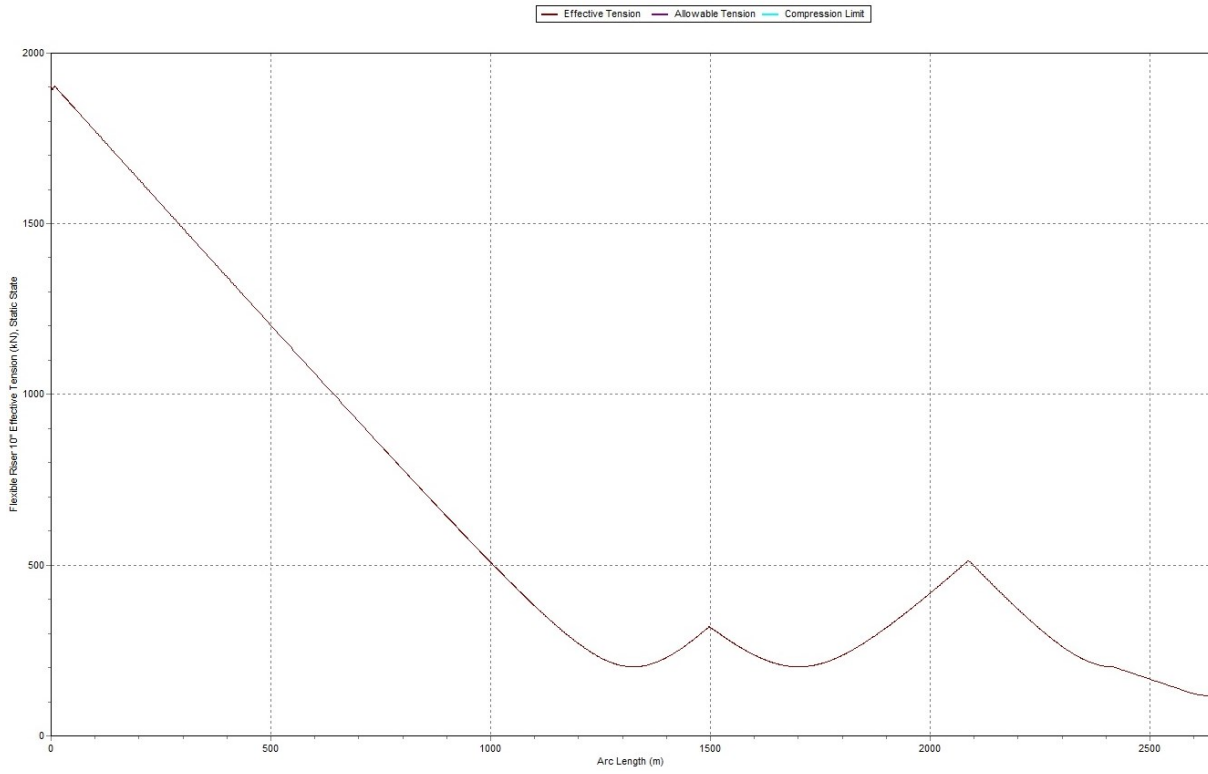

Load Case 3: Normalised Curvature

OrcaFlex 9.7a: Near Flexible-ULS sim (modified 15:05 on 28.04.2014 by OrcaFlex 9.7a)
Range Graph: Flexible Riser 10" Normalised Curvature, Static State

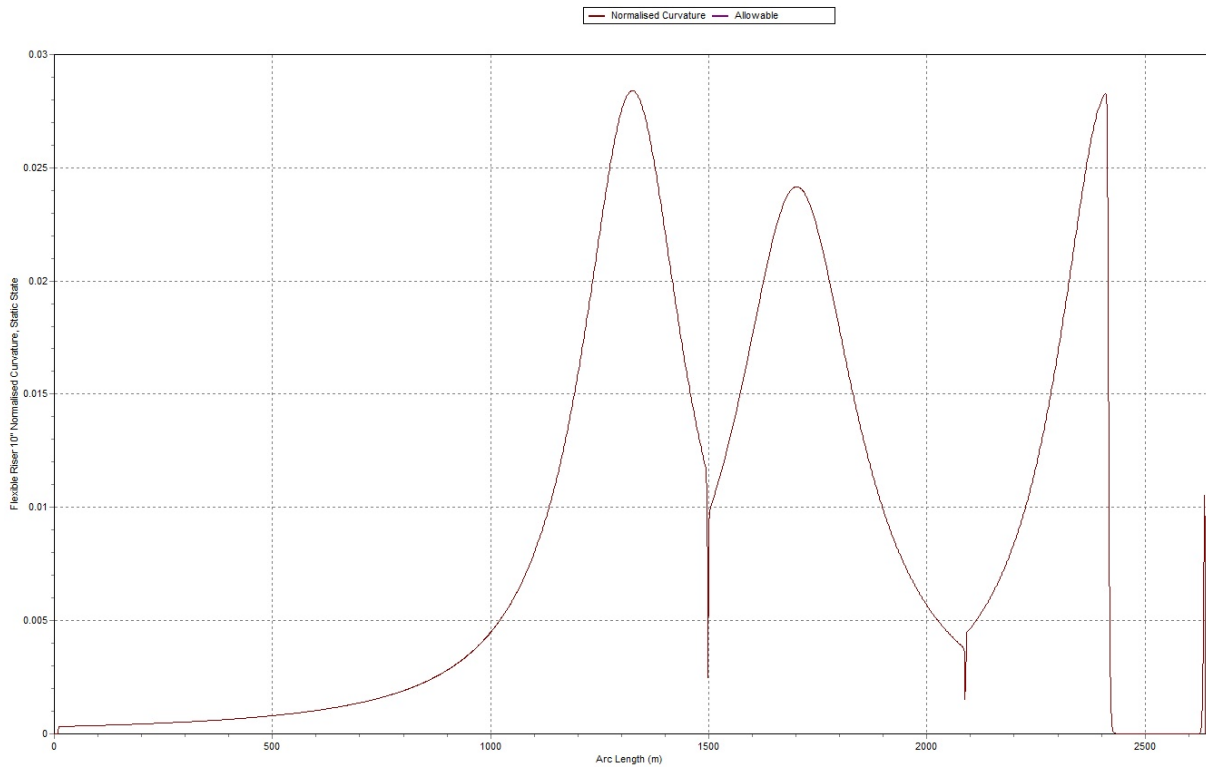

Load Case 4: Effective Tension

OrcaFlex 9.7a: Far Flexible-ALS sim (modified 18:35 on 28.04.2014 by OrcaFlex 9.7a)
Range Graph: Flexible Riser 10" Effective Tension, Static State

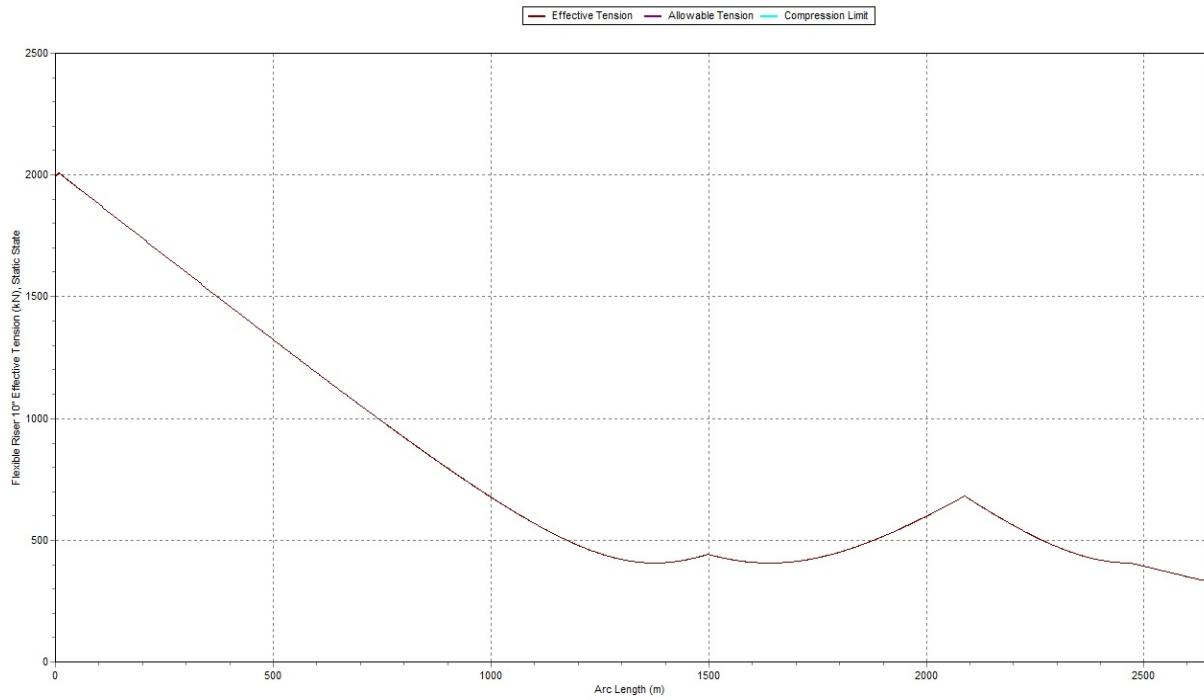

Load Case 4: Normalised Curvature

OrcaFlex 9.7a: Far Flexible-ALS sim (modified 18:35 on 28.04.2014 by OrcaFlex 9.7a)
Range Graph: Flexible Riser 10" Normalised Curvature, Static State

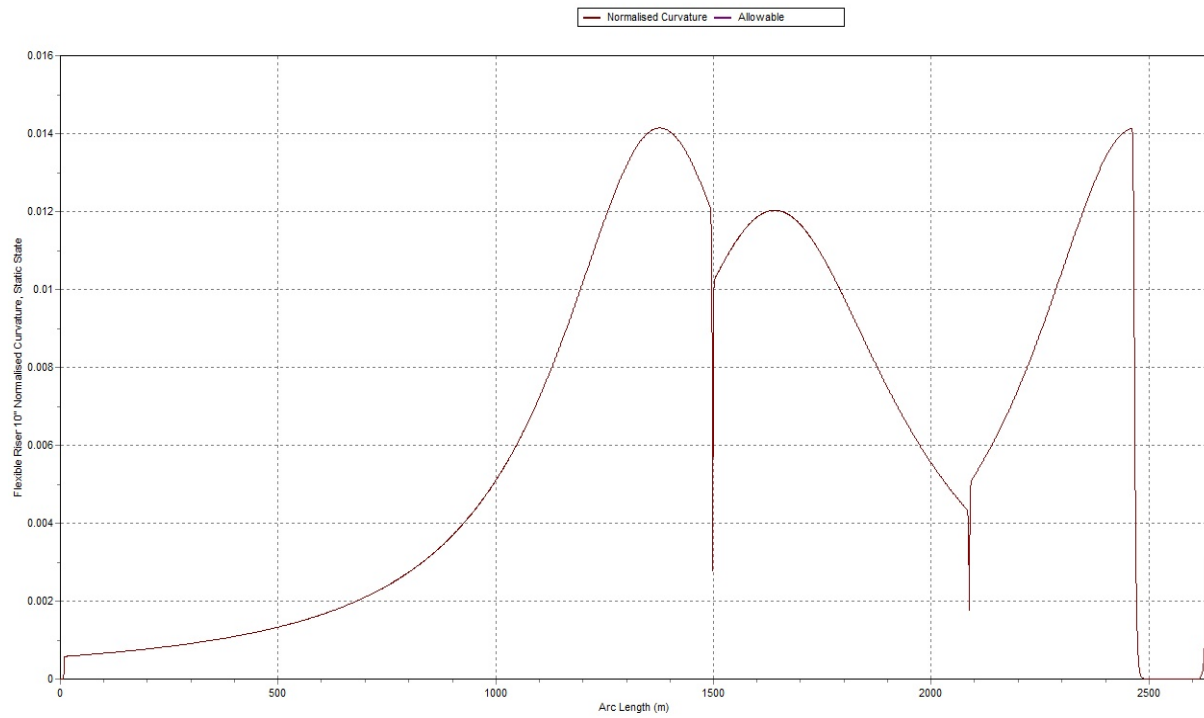

Load Case 5: Effective Tension

OrcaFlex 9.7a: Near Flexible-ALS.sim (modified 15:05 on 28.04.2014 by OrcaFlex 9.7a)
Range Graph: Flexible Riser 10" Effective Tension, Static State

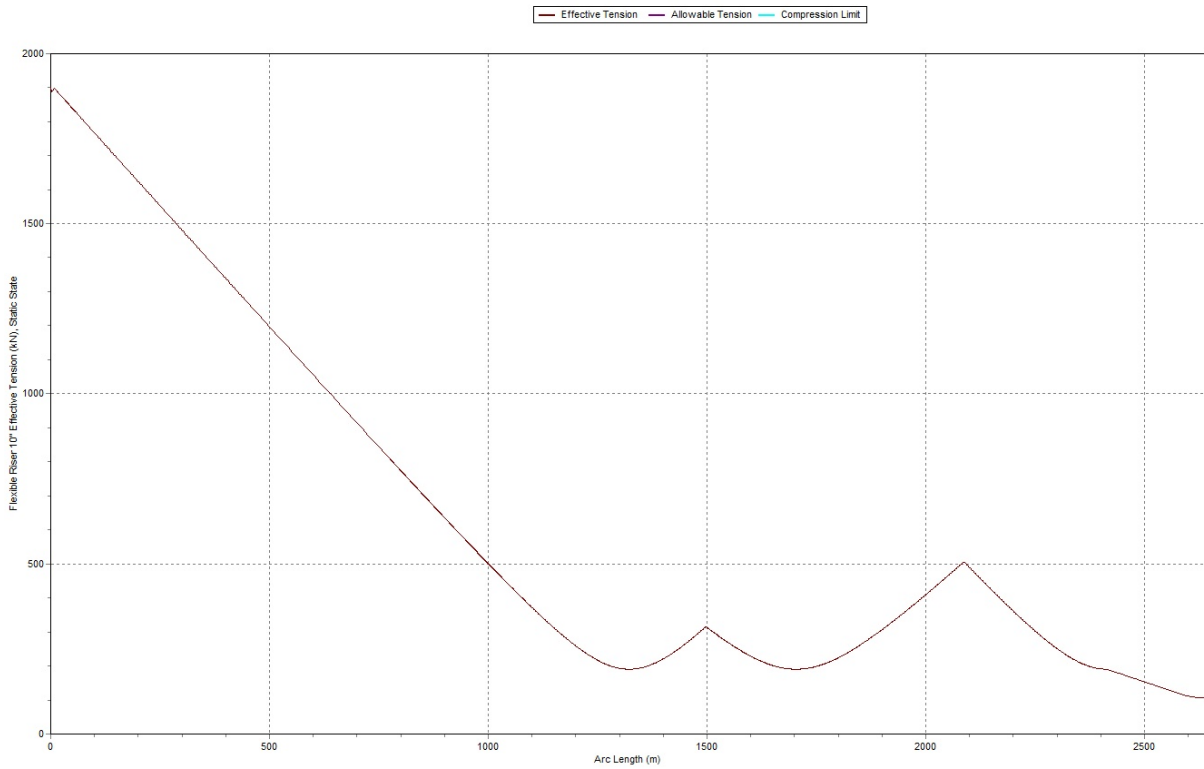

Load Case 5: Normalised Curvature

OrcaFlex 9.7a: Near Flexible-ALS.sim (modified 15:05 on 28.04.2014 by OrcaFlex 9.7a)
Range Graph: Flexible Riser 10" Normalised Curvature, Static State

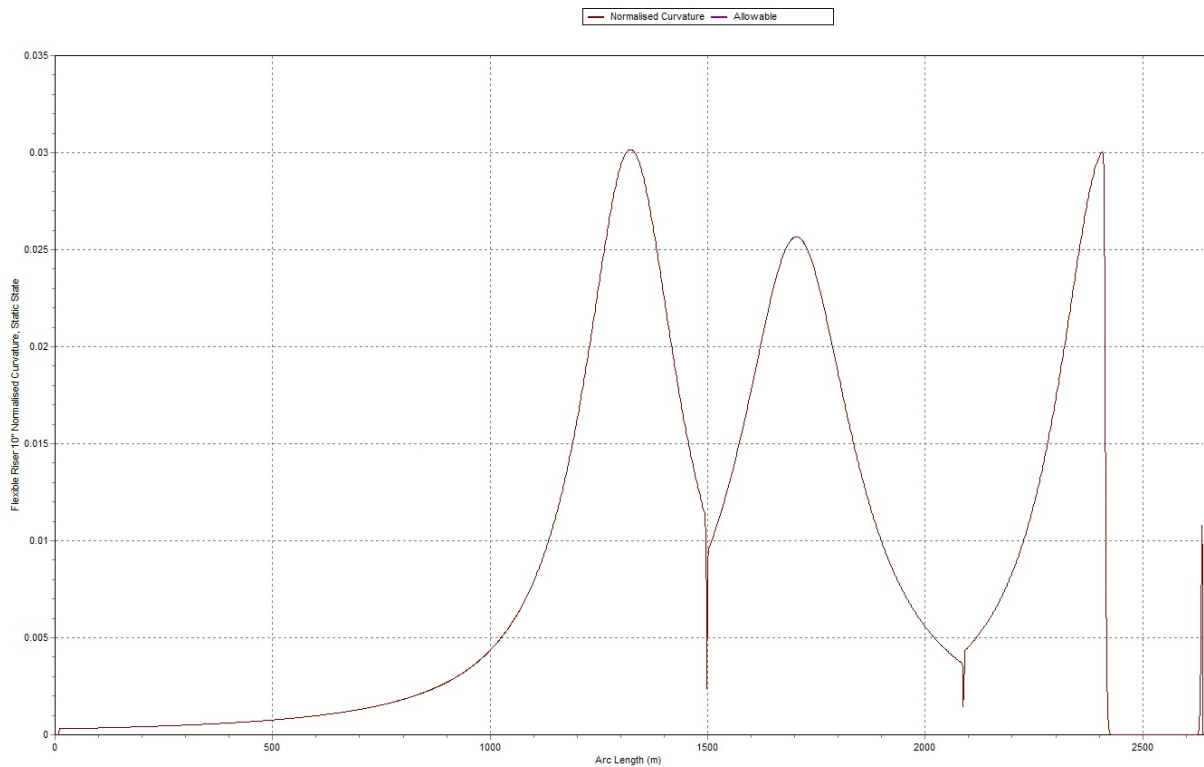

Dynamic Analysis Result

Steel Lazy Wave Riser (SLWR)

Load Case 1: Effective Tension

OrcaFlex 9.7a: Nominal Position.sim (modified 16:31 on 28.04.2014 by OrcaFlex 9.7a)
Range Graph: SLWR Effective Tension, over Whole Simulation

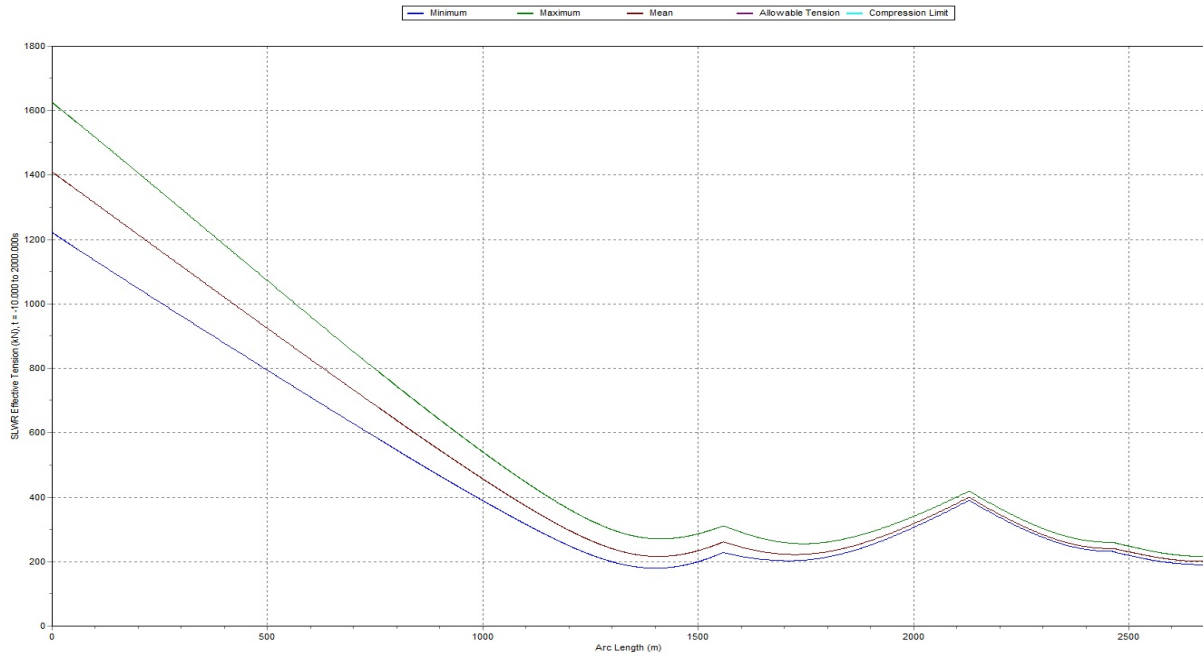

Load Case 1: LRFD Utilization

OrcaFlex 9.7a: Nominal Position.sim (modified 16:31 on 28.04.2014 by OrcaFlex 9.7a)
Range Graph: SLWR DNV OS F201 LRFD, over Whole Simulation

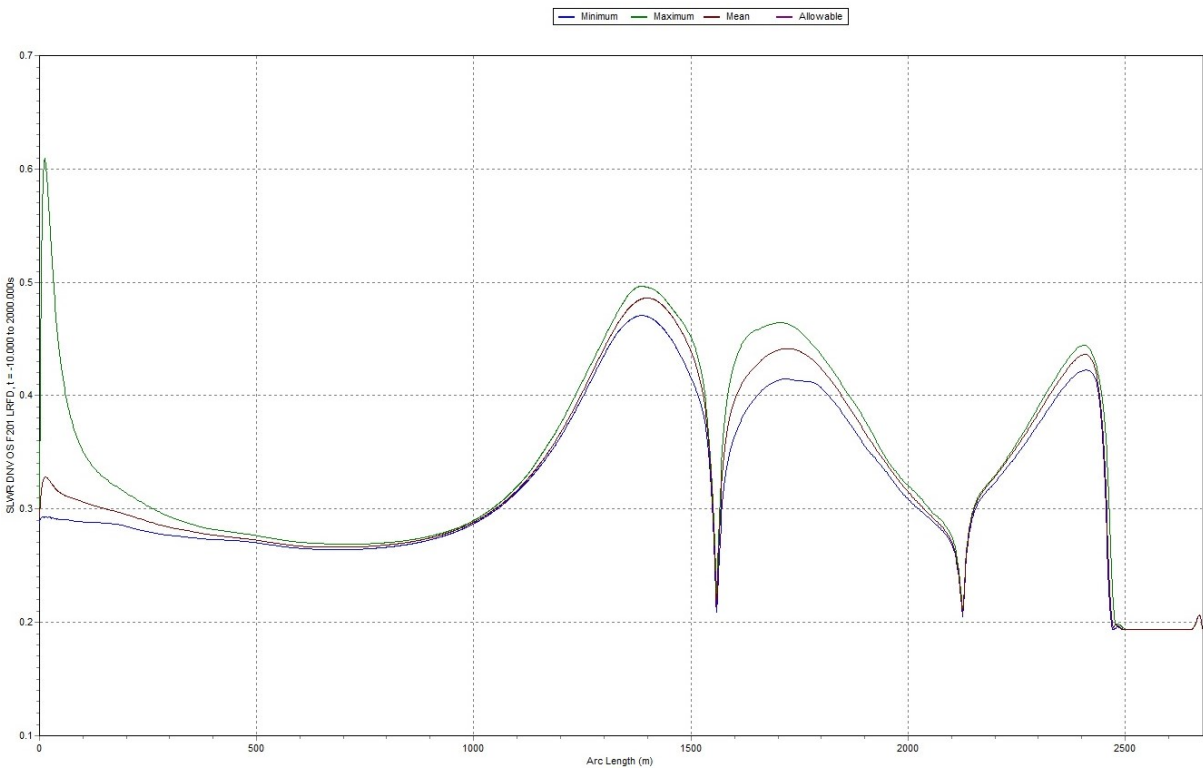

Load Case 2: Effective Tension

OrcaFlex 9.7a: Far Rigid-UJS.slm (modified 16:31 on 28.04.2014 by OrcaFlex 9.7a)
Range Graph: SLWR Effective Tension, over Whole Simulation

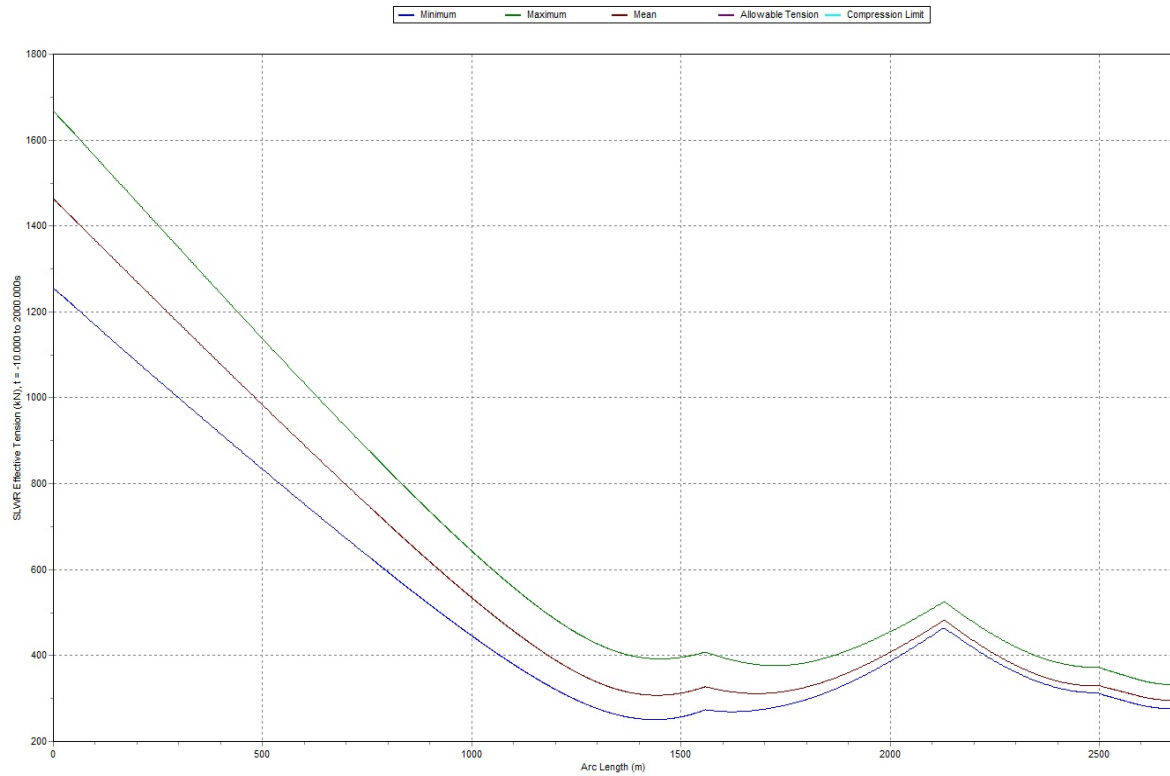

Load Case 2: LRFD Utilization

OrcaFlex 9.7a: Far Rigid-UJS.slm (modified 16:31 on 28.04.2014 by OrcaFlex 9.7a)
Range Graph: SLWR DNV OS F201 LRF, over Whole Simulation

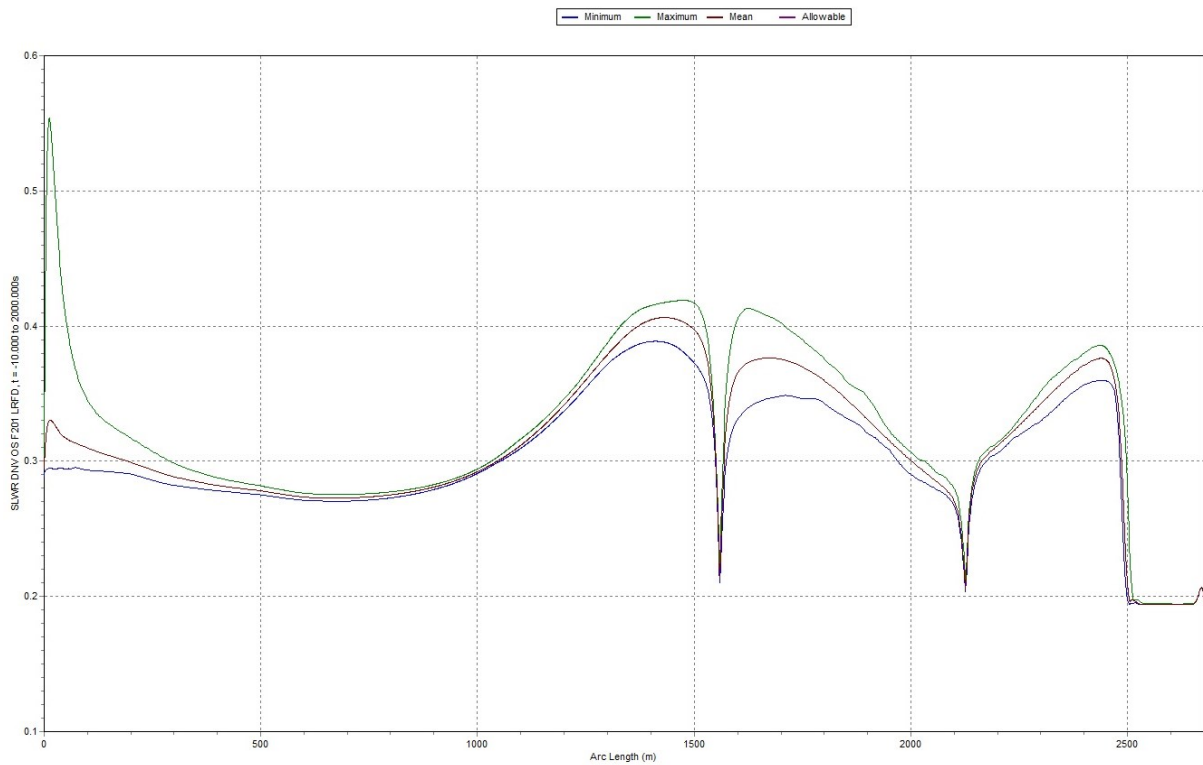

Load Case 3: Effective Tension

OrcaFlex 9.7a: Near Rigid-ULS.sim (modified 20:11 on 28.04.2014 by OrcaFlex 9.7a)
Range Graph: SLWR Effective Tension, over Whole Simulation

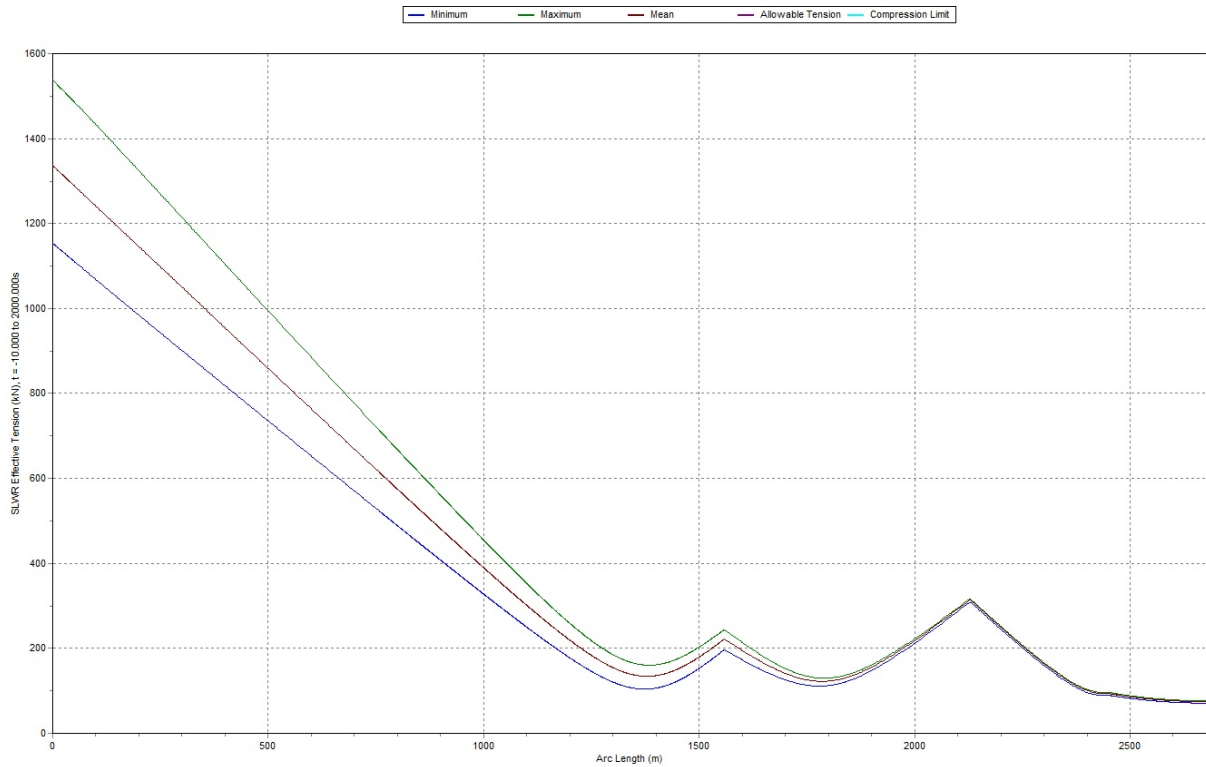

Load Case 3: LRFD Utilization

OrcaFlex 9.7a: Near Rigid-ULS.sim (modified 20:11 on 28.04.2014 by OrcaFlex 9.7a)
Range Graph: SLWR DNV OS F201 LRFD, over Whole Simulation

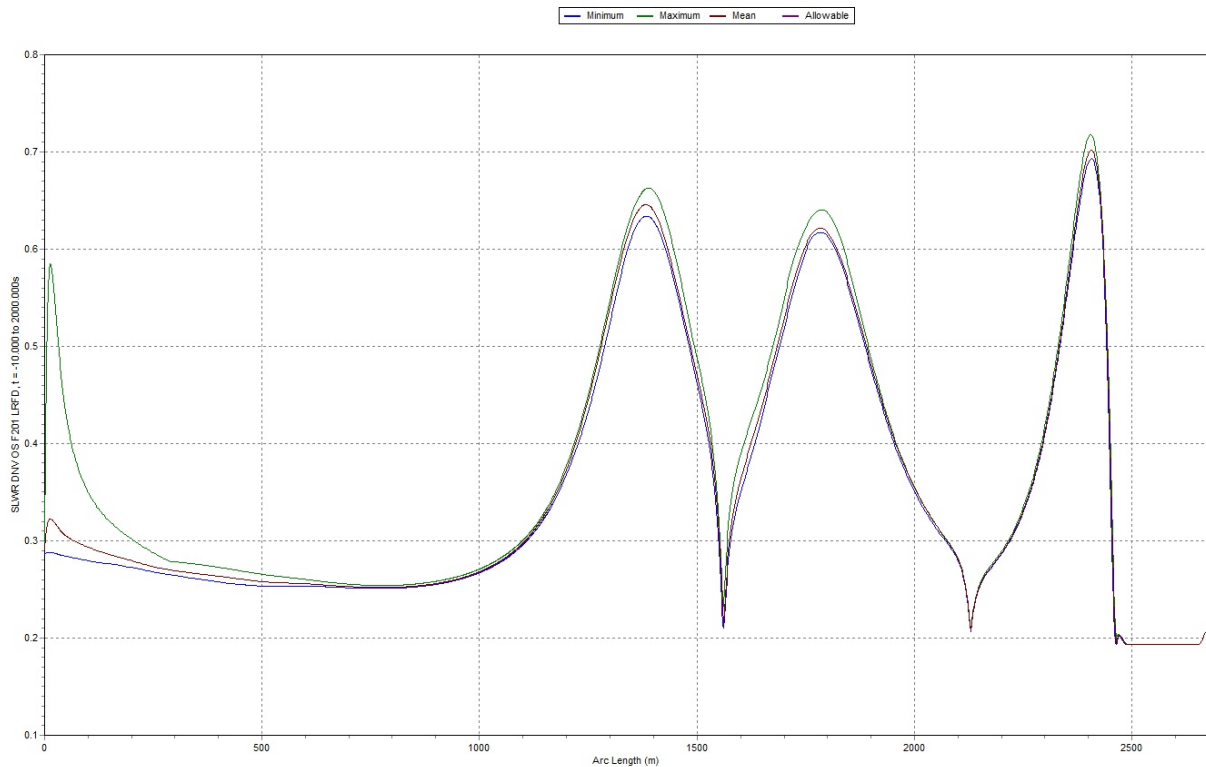

Load Case 4: Effective Tension

OrcaFlex 9.7a: Far Rigid-ALS.dat (modified 18:09 on 28.04.2014 by OrcaFlex 9.7a)
Range Graph: SLWR Effective Tension, over Whole Simulation

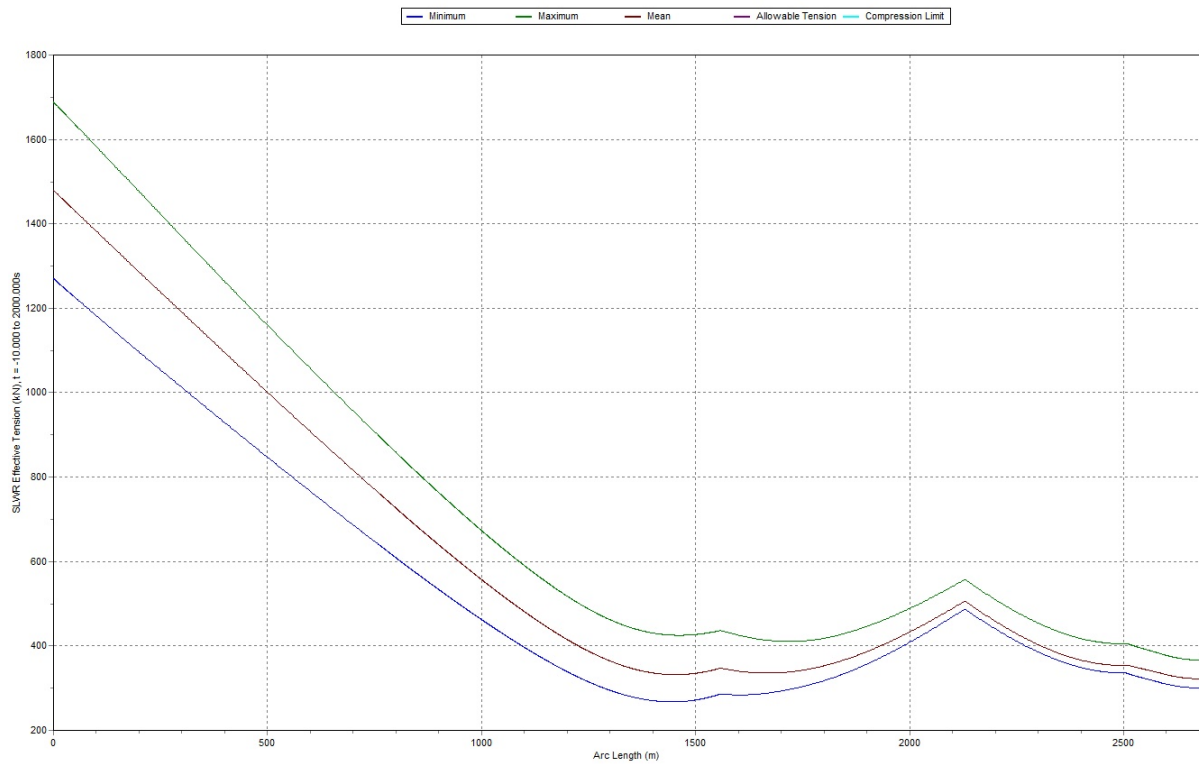

Load Case 4: LRFD Utilization

OrcaFlex 9.7a: Far Rigid-ALS.sim (modified 18:49 on 28.04.2014 by OrcaFlex 9.7a)
Range Graph: SLWR DNV OS F201 LRFD, over Whole Simulation

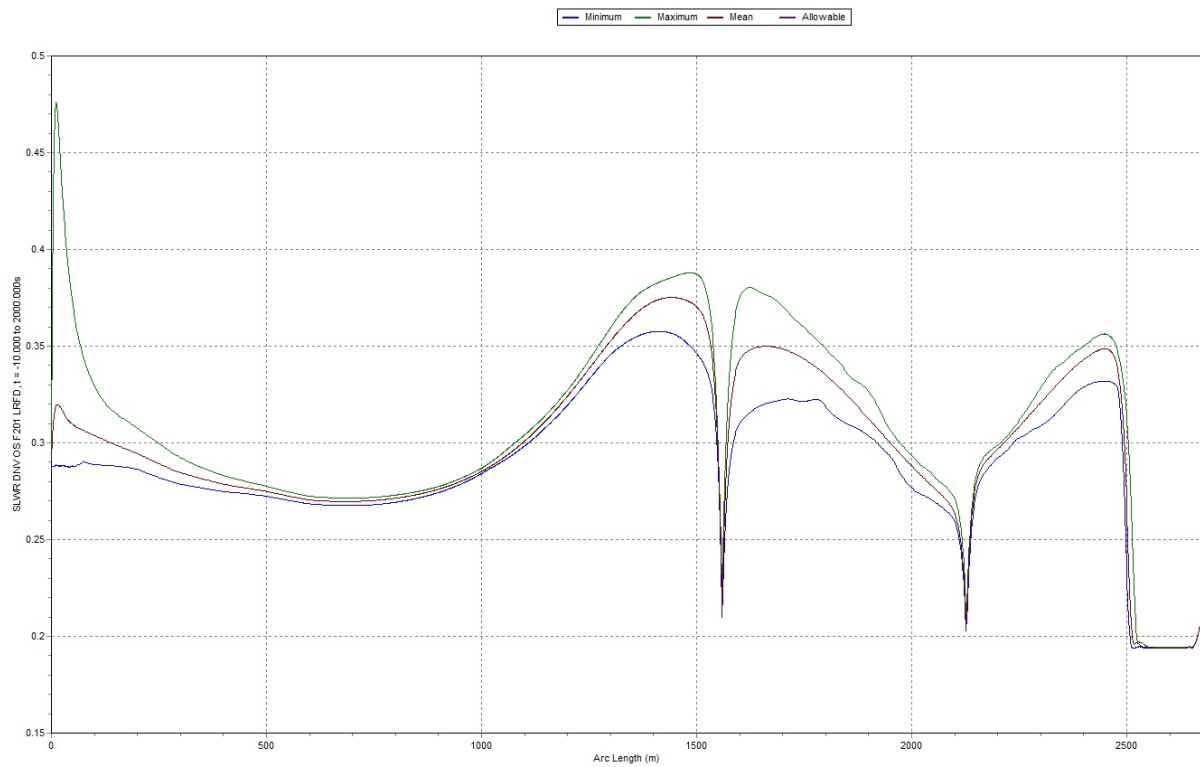

Load Case 5: Effective Tension

OrcaFlex 9.7a: Near Rigid-ALS.dat (modified 12:23 on 29.04.2014 by OrcaFlex 9.7a)
Range Graph: SLWR Effective Tension, over Whole Simulation

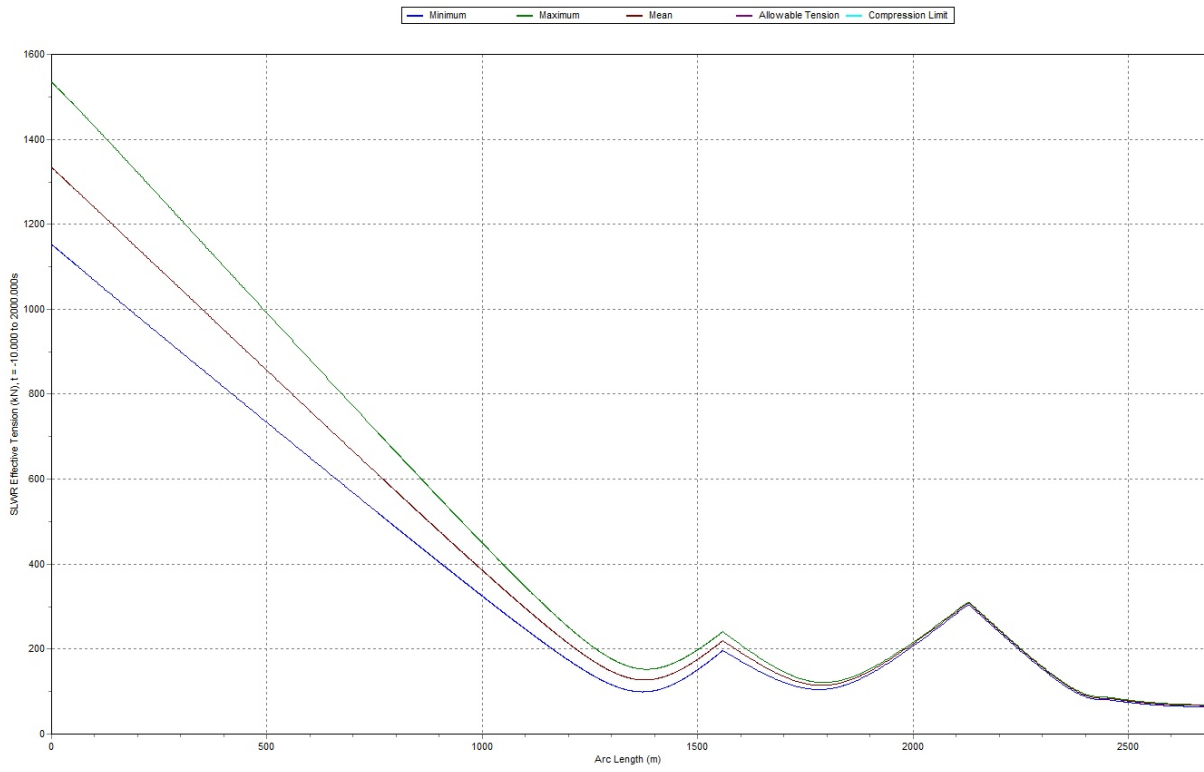

Load Case 5: LRFD Utilization

OrcaFlex 9.7a: Near Rigid-ALS.dat (modified 12:23 on 29.04.2014 by OrcaFlex 9.7a)
Range Graph: SLWR DNV OS F201 LRF, over Whole Simulation

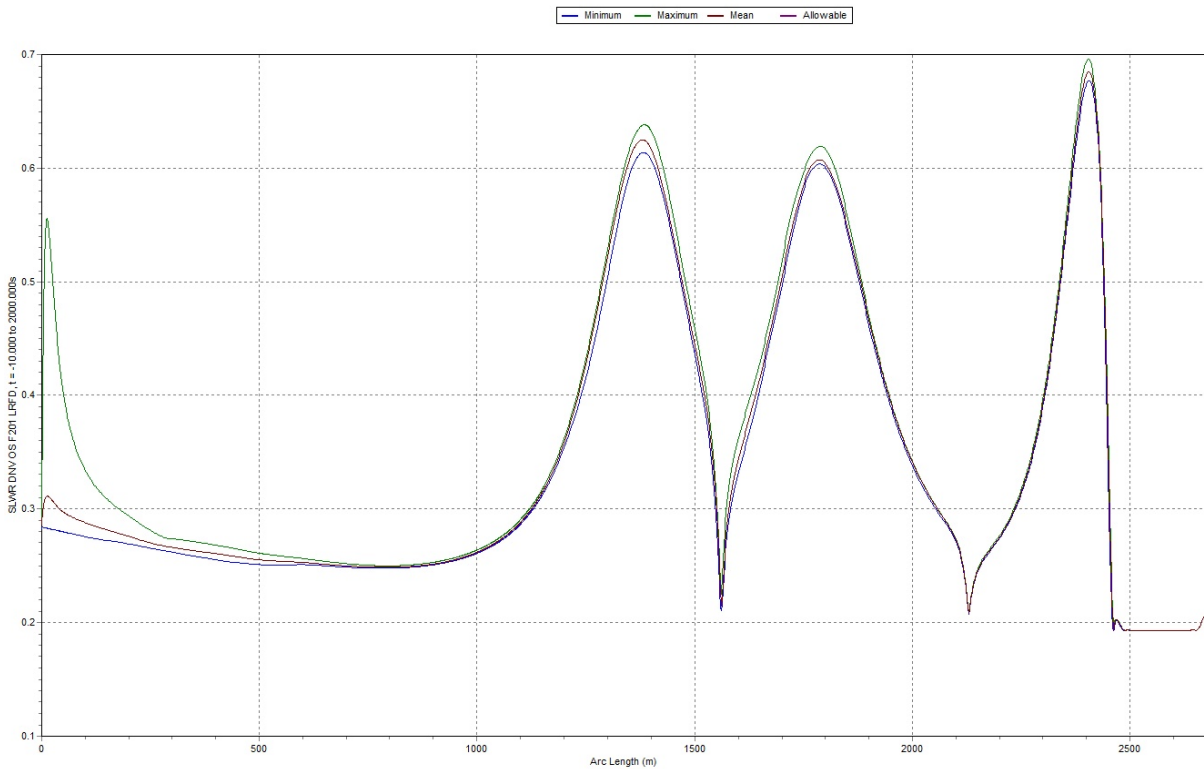

Lazy Wave Flexible Riser

Load Case 1: Effective Tension

OrcaFlex 9.7a: Nominal Flexible.sim (modified 15:04 on 28.04.2014 by OrcaFlex 9.7a)
Range Graph: Flexible Riser 10° Effective Tension, over Whole Simulation

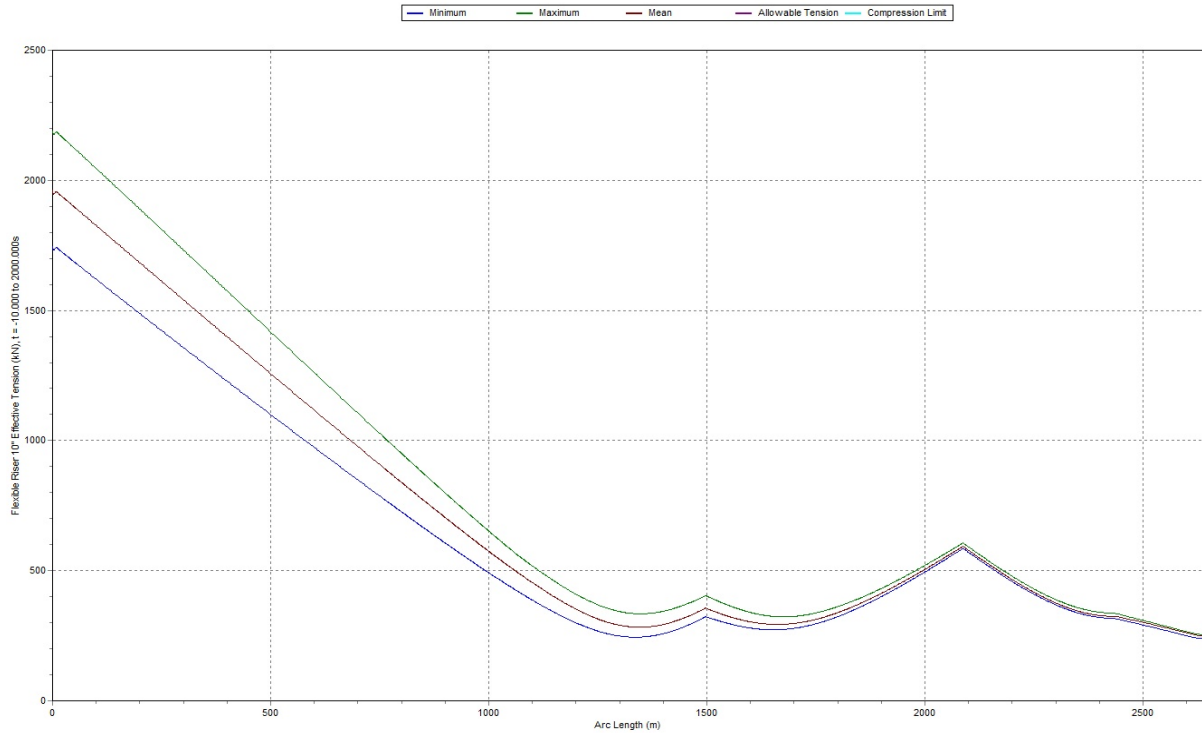

Load Case 1: Normalised Curvature

OrcaFlex 9.7a: Nominal Flexible.sim (modified 15:04 on 28.04.2014 by OrcaFlex 9.7a)
Range Graph: Flexible Riser 10° Normalised Curvature, over Whole Simulation

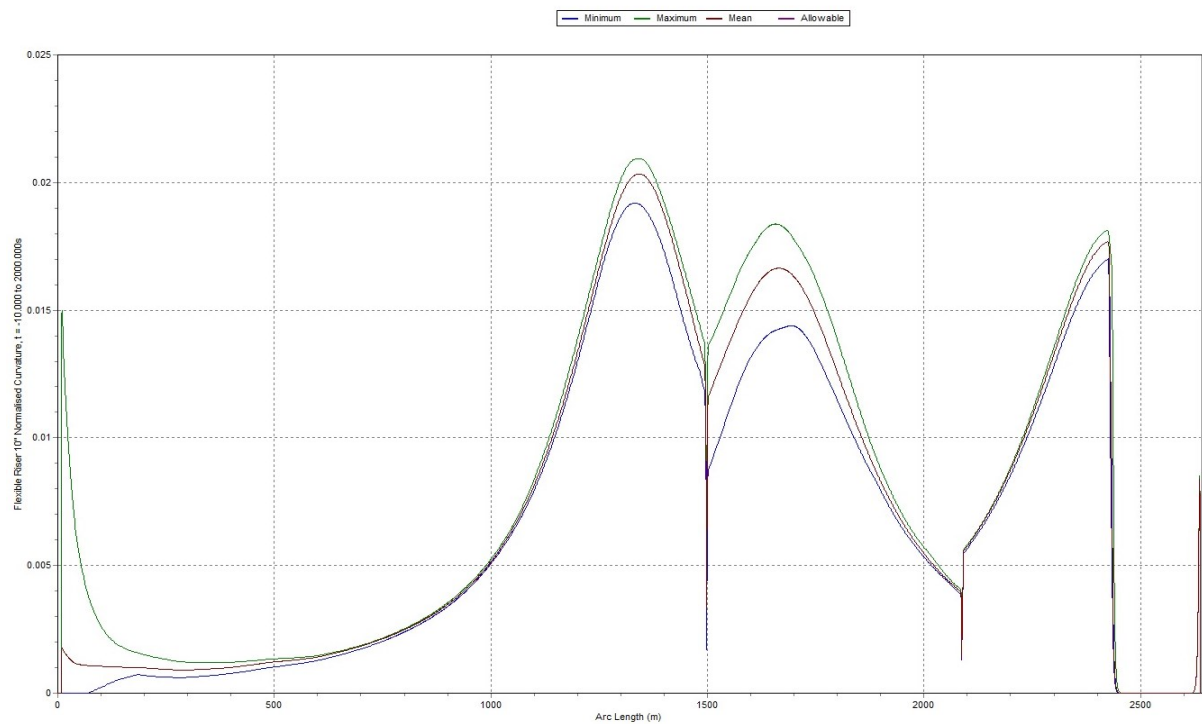

Load Case 2: Effective Tension

OrcaFlex 9.7a: Far Flexible-Uls.sim (modified 15:06 on 28.04.2014 by OrcaFlex 9.7a)
Range Graph: Flexible Riser 10° Effective Tension, over Whole Simulation

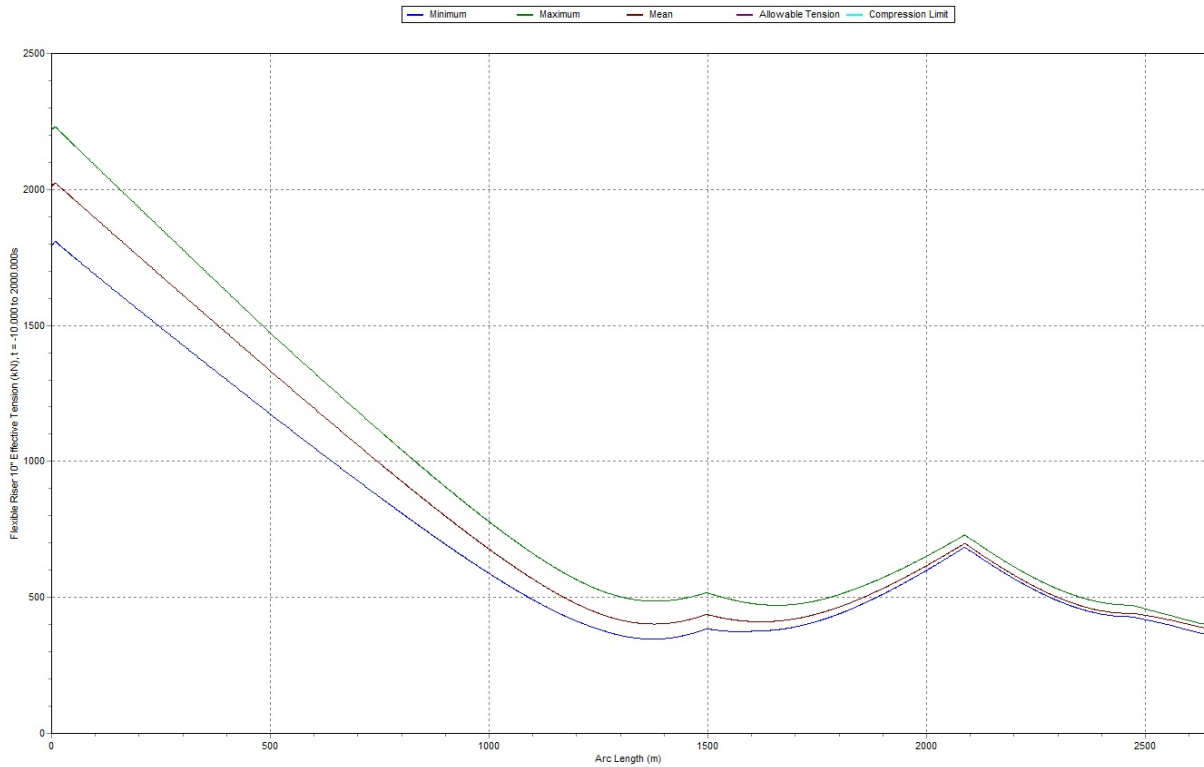

Load Case 2: Normalised Curvature

OrcaFlex 9.7a: Far Flexible-Uls.sim (modified 15:06 on 28.04.2014 by OrcaFlex 9.7a)
Range Graph: Flexible Riser 10° Normalised Curvature, over Whole Simulation

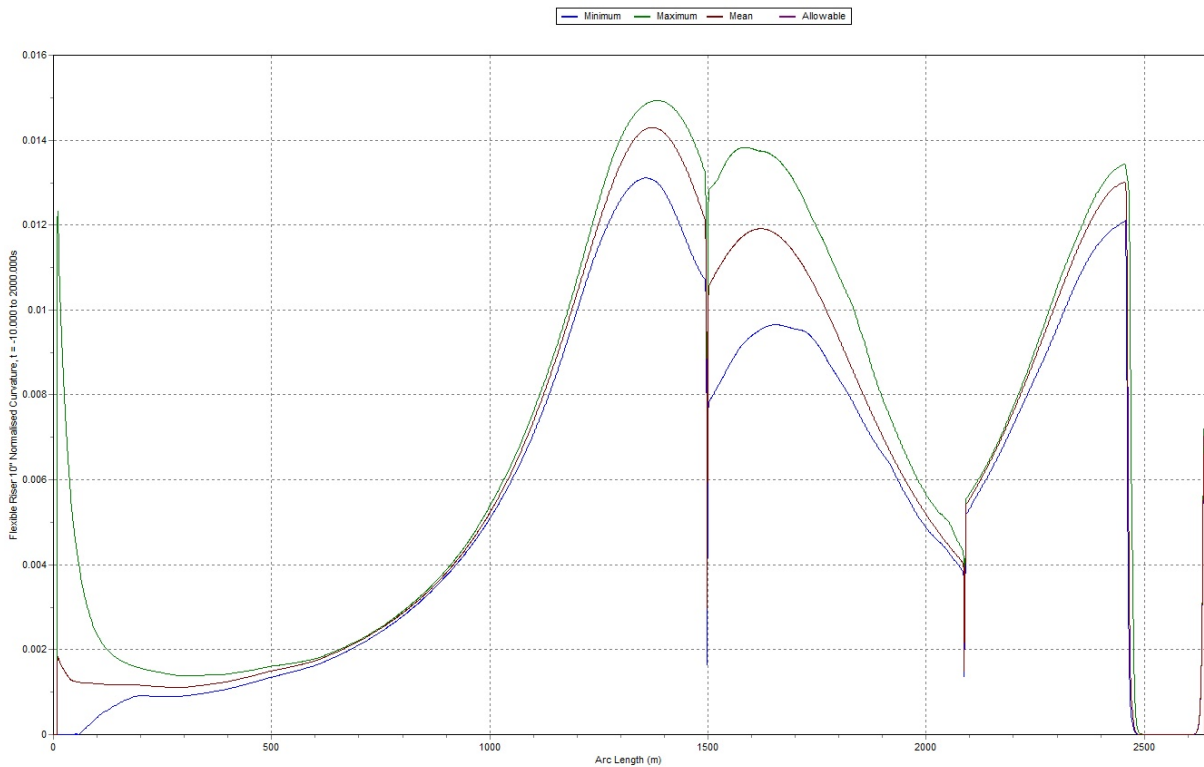

Load Case 3: Effective Tension

OrcaFlex 9.7a: Near Flexible-ULS sim (modified 14:46 on 29.04.2014 by OrcaFlex 9.7a)
Range Graph: Flexible Riser 10⁷ Effective Tension, over Whole Simulation

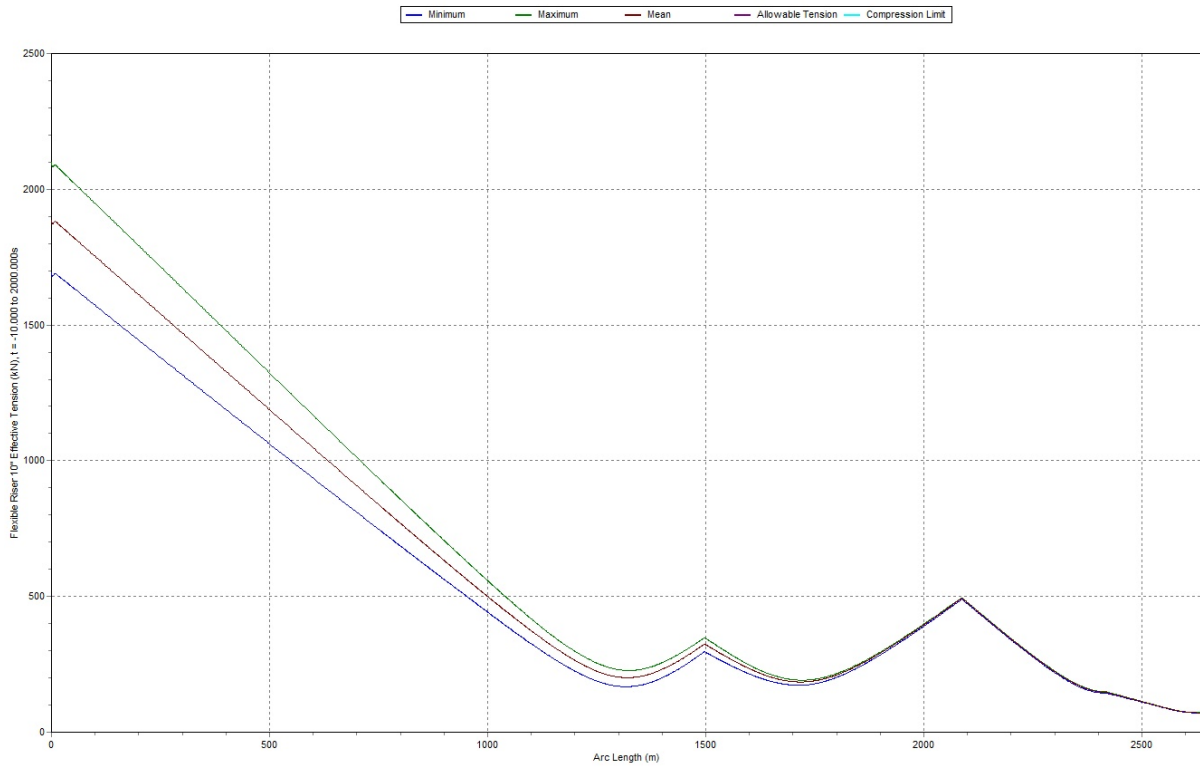

Load Case 3: Normalised Curvature

OrcaFlex 9.7a: Near Flexible-ULS sim (modified 14:46 on 29.04.2014 by OrcaFlex 9.7a)
Range Graph: Flexible Riser 10⁷ Normalised Curvature, over Whole Simulation

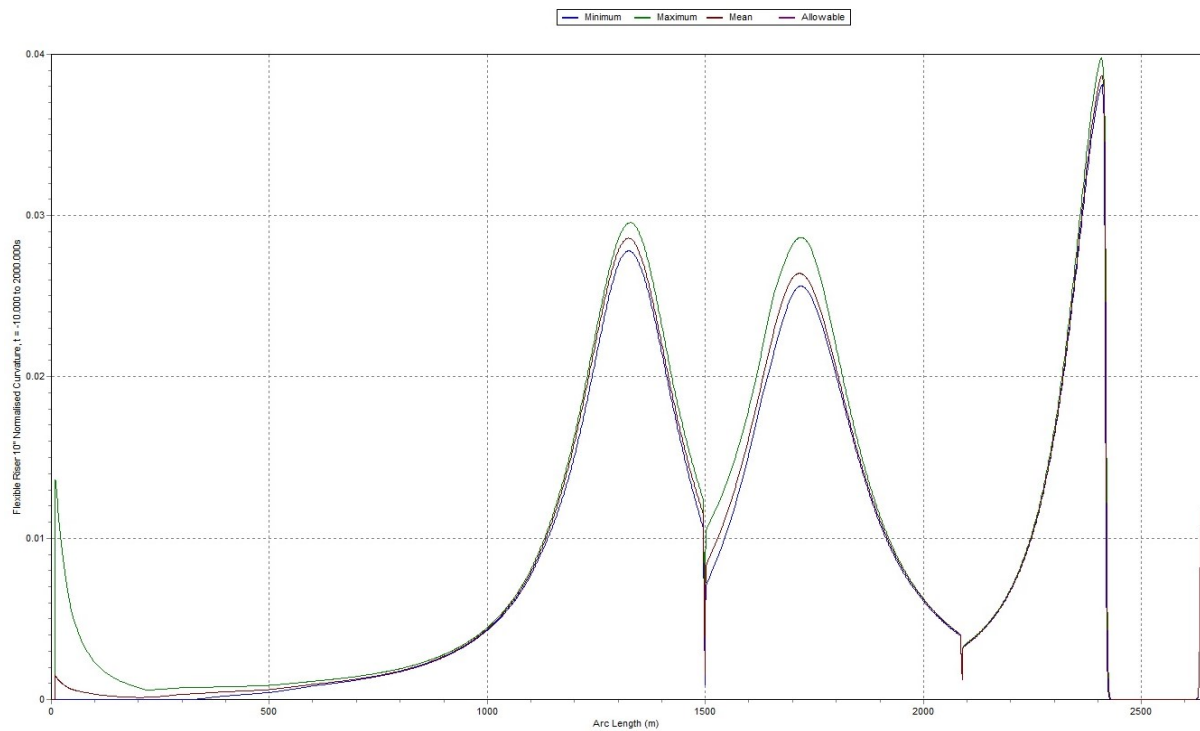

Load Case 4: Effective Tension

OrcaFlex 9.7a: Far Flexible-ALS sim (modified 15:06 on 28.04.2014 by OrcaFlex 9.7a)
Range Graph: Flexible Riser 10° Effective Tension, over Whole Simulation

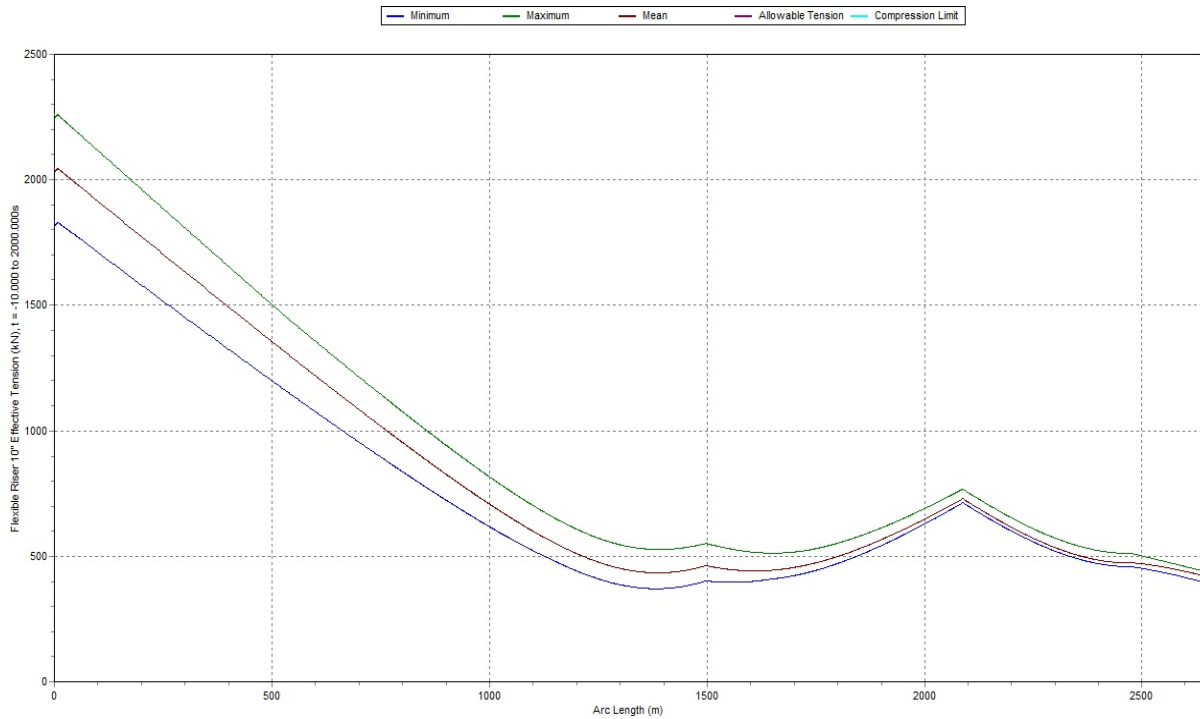

Load Case 4: Normalised Curvature

OrcaFlex 9.7a: Far Flexible-ALS sim (modified 15:06 on 28.04.2014 by OrcaFlex 9.7a)
Range Graph: Flexible Riser 10° Normalised Curvature, over Whole Simulation

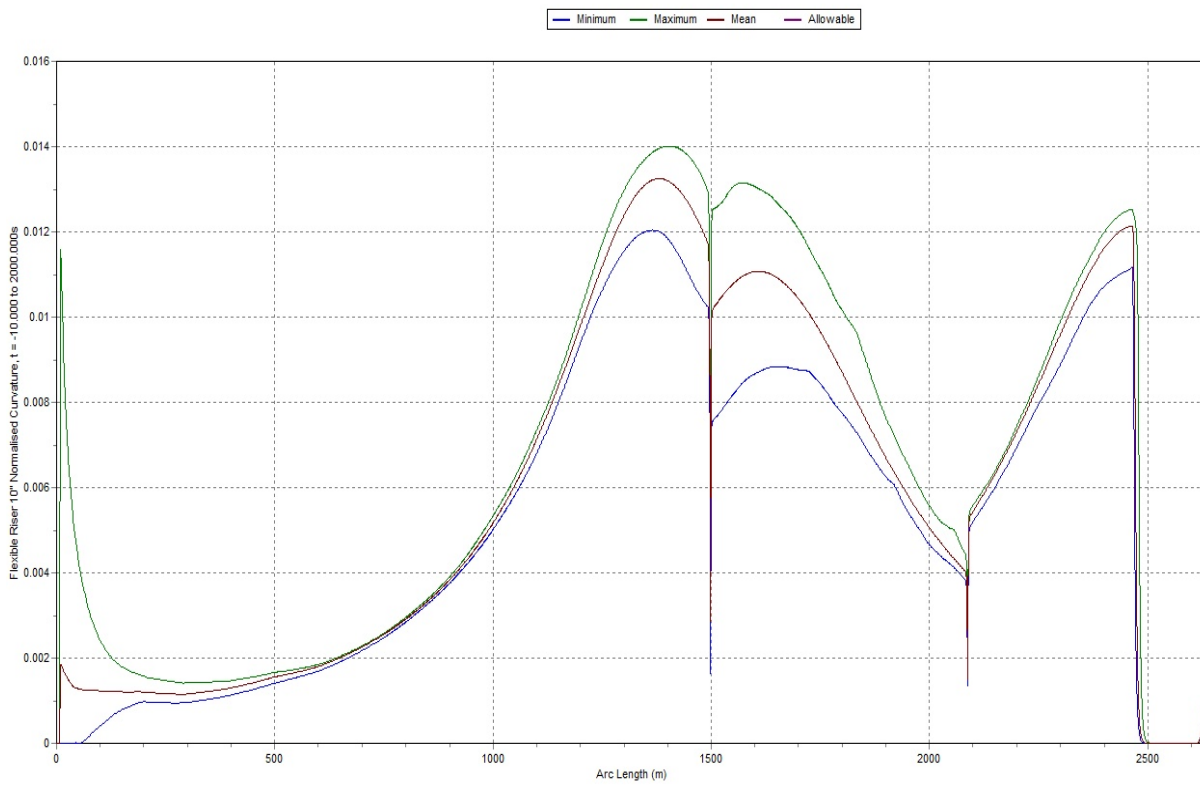

Load Case 5: Effective Tension

OrcaFlex 9.7a: Near Flexible-ALS.sim (modified 11:59 on 29.04.2014 by OrcaFlex 9.7a)
Range Graph: Flexible Riser 10° Effective Tension, over Whole Simulation

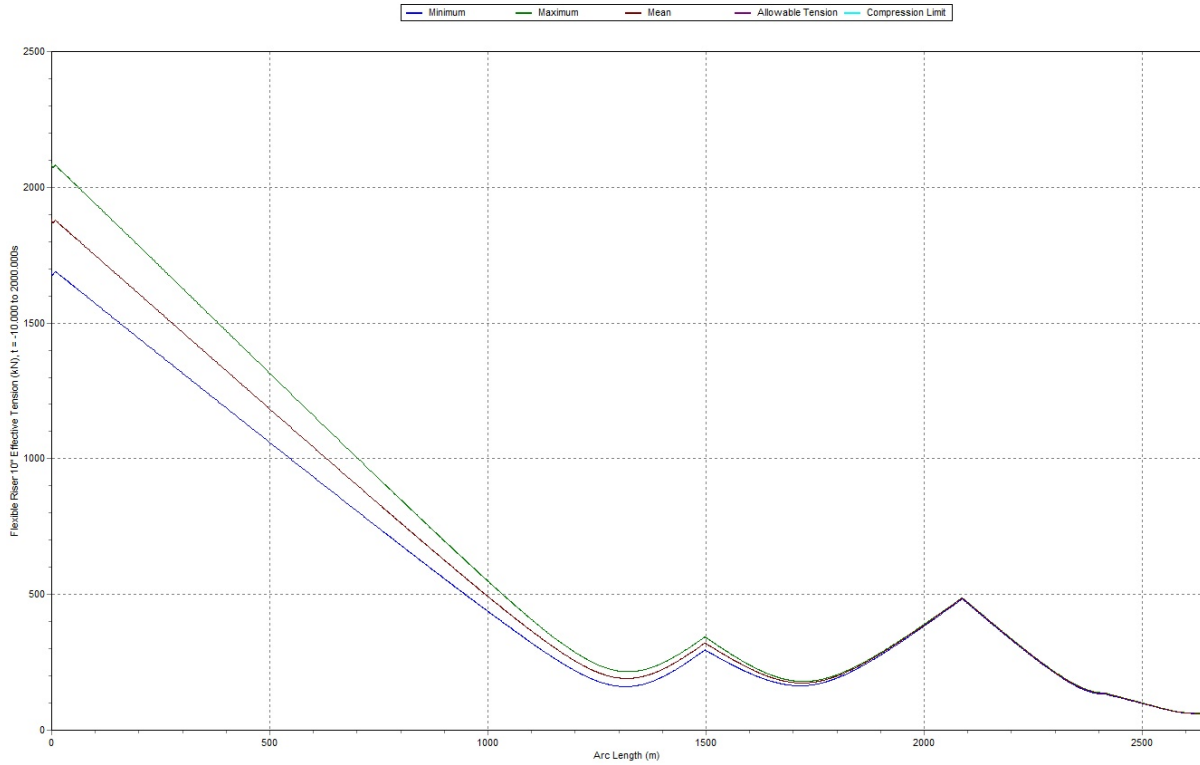

Load Case 5: Normalised Curvature

OrcaFlex 9.7a: Near Flexible-ALS.sim (modified 11:59 on 29.04.2014 by OrcaFlex 9.7a)
Range Graph: Flexible Riser 10° Normalised Curvature, over Whole Simulation

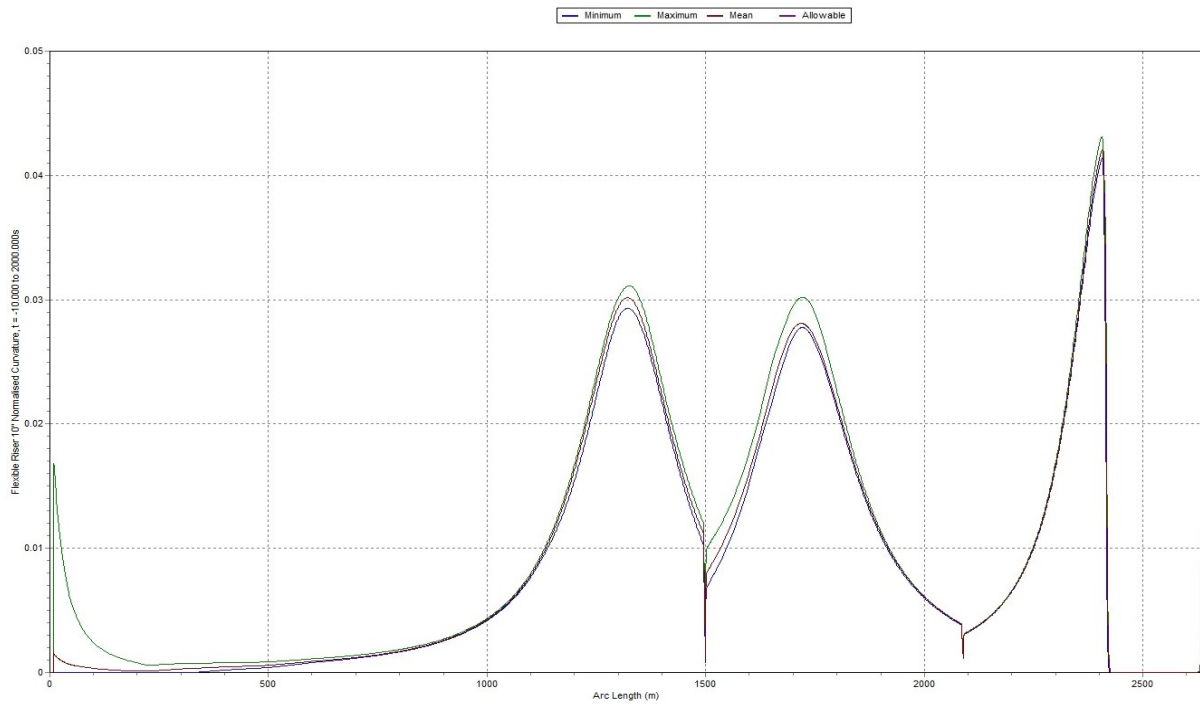

Fatigue Analysis Result

Steel Lazy Wave Riser (SLWR)

1. Wave Direction 0

Fatigue Damage Summary	
OrcaFlex 9.7a: fatigue 0.ftg (modified 21:55 on 27.04.2014 by OrcaFlex 9.7a)	
Title: fatigue result wave direction 0	
Damage Calculation: Homogeneous pipe stress	
Analysis Type: Rainflow	
Worst Damage	
Damage over Total Exposure	0.0055
Total Exposure Time (years)	11.611
Life (years)	2124.5
Arc Length (m)	0
Theta (deg)	0
SN-curve	C2 Curve
Radial Position	Outer
SCF	1.2
Thickness Correction Factor	1
Fatigue Damage Summary	
OrcaFlex 9.7a: fatigue 0.ftg (modified 21:55 on 27.04.2014 by OrcaFlex 9.7a)	
Title: fatigue result wave direction 0	
Damage Calculation: Homogeneous pipe stress	
Analysis Type: Rainflow	
Worst Damage	
Damage over Total Exposure	0.008
Total Exposure Time (years)	11.611
Life (years)	1447.4
Arc Length (m)	0
Theta (deg)	0
SN-curve	D Curve
Radial Position	Outer
SCF	1.2
Thickness Correction Factor	1

2. Wave Direction 30

Fatigue Damage Summary						
OrcaFlex 9.7a: fatigue 30.ftg (modified 20:27 on 26.04.2014 by OrcaFlex 9.7a)						
Title: Fatigue for wave direction 30 degree						
Damage Calculation: Homogeneous pipe stress						
Analysis Type: Rainflow						
Worst Damage						
Damage over Total Exposure	0.0041					
Total Exposure Time (years)	10.254					
Life (years)	2474.2					
Arc Length (m)	0					
Theta (deg)	0					
SN-curve	C2 Curve					
Radial Position	Outer					
SCF	1.2					
Thickness Correction Factor	1					
Fatigue Damage Summary						
OrcaFlex 9.7a: fatigue 30.ftg (modified 20:27 on 26.04.2014 by OrcaFlex 9.7a)						
Title: Fatigue for wave direction 30 degree						
Damage Calculation: Homogeneous pipe stress						
Analysis Type: Rainflow						
Worst Damage						
Damage over Total Exposure	0.0067					
Total Exposure Time (years)	10.254					
Life (years)	1524.7					
Arc Length (m)	0					
Theta (deg)	0					
SN-curve	D Curve					
Radial Position	Outer					
SCF	1.2					
Thickness Correction Factor	1					

3. Wave Direction 60

Fatigue Damage Summary						
OrcaFlex 9.7a: fatigue 60.ftg (modified 22:21 on 27.04.2014 by OrcaFlex 9.7a)						
Title: fatigue result for wave direction 60 degree						
Damage Calculation: Homogeneous pipe stress						
Analysis Type: Rainflow						
Worst Damage						
Damage over Total Exposure	0.0011					
Total Exposure Time (years)	2.6563					
Life (years)	2352					
Arc Length (m)	0					
Theta (deg)	0					
SN-curve	C2 Curve					
Radial Position	Outer					
SCF	1.2					
Thickness Correction Factor	1					
Fatigue Damage Summary						
OrcaFlex 9.7a: fatigue 60.ftg (modified 22:21 on 27.04.2014 by OrcaFlex 9.7a)						
Title: fatigue result for wave direction 60 degree						
Damage Calculation: Homogeneous pipe stress						
Analysis Type: Rainflow						
Worst Damage						
Damage over Total Exposure	0.0017					
Total Exposure Time (years)	2.6563					
Life (years)	1582.2					
Arc Length (m)	0					
Theta (deg)	0					
SN-curve	D Curve					
Radial Position	Outer					
SCF	1.2					
Thickness Correction Factor	1					

4. Wave Direction 90

Fatigue Damage Summary							
OrcaFlex 9.7a: fatigue 90.ftg (modified 13:05 on 27.04.2014 by OrcaFlex 9.7a)							
Title: Fatigue result for wave diection 90 degree							
Damage Calculation: Homogeneous pipe stress							
Analysis Type: Rainflow							
Worst Damage							
Damage over Total Exposure	0.0005						
Total Exposure Time (years)	1.1328						
Life (years)	2393.6						
Arc Length (m)	0						
Theta (deg)	0						
SN-curve	C2 Curve						
Radial Position	Outer						
SCF	1.2						
Thickness Correction Factor	1						
Fatigue Damage Summary							
OrcaFlex 9.7a: fatigue 90.ftg (modified 13:05 on 27.04.2014 by OrcaFlex 9.7a)							
Title: Fatigue result for wave diection 90 degree							
Damage Calculation: Homogeneous pipe stress							
Analysis Type: Rainflow							
Worst Damage							
Damage over Total Exposure	0.0007						
Total Exposure Time (years)	1.1328						
Life (years)	1609.9						
Arc Length (m)	0						
Theta (deg)	0						
SN-curve	D Curve						
Radial Position	Outer						
SCF	1.2						
Thickness Correction Factor	1						

5. Wave Direction 120

Fatigue Damage Summary						
OrcaFlex 9.7a: heading 120.ftg (modified 19:03 on 27.04.2014 by OrcaFlex 9.7a)						
Title: fatigue result for wave direction 120 degree						
Damage Calculation: Homogeneous pipe stress						
Analysis Type: Rainflow						
Worst Damage						
Damage over Total Exposure	0.0006					
Total Exposure Time (years)	1.377					
Life (years)	2352					
Arc Length (m)	0					
Theta (deg)	0					
SN-curve	C2 Curve					
Radial Position	Outer					
SCF	1.2					
Thickness Correction Factor	1					
Fatigue Damage Summary						
OrcaFlex 9.7a: heading 120.ftg (modified 19:03 on 27.04.2014 by OrcaFlex 9.7a)						
Title: fatigue result for wave direction 120 degree						
Damage Calculation: Homogeneous pipe stress						
Analysis Type: Rainflow						
Worst Damage						
Damage over Total Exposure	0.0009					
Total Exposure Time (years)	1.377					
Life (years)	1582.2					
Arc Length (m)	0					
Theta (deg)	0					
SN-curve	D Curve					
Radial Position	Outer					
SCF	1.2					
Thickness Correction Factor	1					

6. Wave Direction 150

Fatigue Damage Summary						
OrcaFlex 9.7a: fatigue 150.ftg (modified 19:29 on 27.04.2014 by OrcaFlex 9.7a)						
Title: fatigue result for wave direction 150 degree						
Damage Calculation: Homogeneous pipe stress						
Analysis Type: Rainflow						
Worst Damage						
Damage over Total Exposure	0.0011					
Total Exposure Time (years)	2.5781					
Life (years)	2260					
Arc Length (m)	0					
Theta (deg)	0					
SN-curve	C2 Curve					
Radial Position	Outer					
SCF	1.2					
Thickness Correction Factor	1					
Fatigue Damage Summary						
OrcaFlex 9.7a: fatigue 150.ftg (modified 19:29 on 27.04.2014 by OrcaFlex 9.7a)						
Title: fatigue result for wave direction 150 degree						
Damage Calculation: Homogeneous pipe stress						
Analysis Type: Rainflow						
Worst Damage						
Damage over Total Exposure	0.0017					
Total Exposure Time (years)	2.5781					
Life (years)	1524.7					
Arc Length (m)	0					
Theta (deg)	0					
SN-curve	D Curve					
Radial Position	Outer					
SCF	1.2					
Thickness Correction Factor	1					

7. Wave Direction 180

Fatigue Damage Summary							
OrcaFlex 9.7a: fatigue 180.ftg (modified 19:50 on 27.04.2014 by OrcaFlex 9.7a)							
Title: fatigue result wave direction 180 degree							
Damage Calculation: Homogeneous pipe stress							
Analysis Type: Rainflow							
Worst Damage							
Damage over Total Exposure	0.0021						
Total Exposure Time (years)	4.502						
Life (years)	2124.5						
Arc Length (m)	0						
Theta (deg)	0						
SN-curve	C2 Curve						
Radial Position	Outer						
SCF	1.2						
Fatigue Damage Summary							
OrcaFlex 9.7a: fatigue 180.ftg (modified 19:50 on 27.04.2014 by OrcaFlex 9.7a)							
Title: fatigue result wave direction 180 degree							
Damage Calculation: Homogeneous pipe stress							
Analysis Type: Rainflow							
Worst Damage							
Damage over Total Exposure	0.0031						
Total Exposure Time (years)	4.502						
Life (years)	1447.4						
Arc Length (m)	0						
Theta (deg)	0						
SN-curve	D Curve						
Radial Position	Outer						
SCF	1.2						
Thickness Correction Factor	1						

8. Wave Direction 210

Fatigue Damage Summary						
OrcaFlex 9.7a: fatigue 210.ftg (modified 20:15 on 27.04.2014 by OrcaFlex 9.7a)						
Title: fatigue result wave direction 210 degree						
Damage Calculation: Homogeneous pipe stress						
Analysis Type: Rainflow						
Worst Damage						
Damage over Total Exposure	0.0069					
Total Exposure Time (years)	13.672					
Life (years)	1987.2					
Arc Length (m)	0					
Theta (deg)	0					
SN-curve	C2 Curve					
Radial Position	Outer					
SCF	1.2					
Thickness Correction Factor	1					
Fatigue Damage Summary						
OrcaFlex 9.7a: fatigue 210.ftg (modified 20:15 on 27.04.2014 by OrcaFlex 9.7a)						
Title: fatigue result wave direction 210 degree						
Damage Calculation: Homogeneous pipe stress						
Analysis Type: Rainflow						
Worst Damage						
Damage over Total Exposure	0.01					
Total Exposure Time (years)	13.672					
Life (years)	1367					
Arc Length (m)	0					
Theta (deg)	0					
SN-curve	D Curve					
Radial Position	Outer					
SCF	1.2					
Thickness Correction Factor	1					

9. Wave Direction 240

Fatigue Damage Summary							
OrcaFlex 9.7a: fatigue 240.ftg (modified 21:40 on 26.04.2014 by OrcaFlex 9.7a)							
Title: Fatigue wave direction 240 degree							
Damage Calculation: Homogeneous pipe stress							
Analysis Type: Rainflow							
Worst Damage							
Damage over Total Exposure	0.009						
Total Exposure Time (years)	19.512						
Life (years)	2161.9						
Arc Length (m)	0						
Theta (deg)	0						
SN-curve	C2 Curve						
Radial Position	Outer						
SCF	1.2						
Thickness Correction Factor	1						
Fatigue Damage Summary							
OrcaFlex 9.7a: fatigue 240.ftg (modified 21:40 on 26.04.2014 by OrcaFlex 9.7a)							
Title: Fatigue wave direction 240 degree							
Damage Calculation: Homogeneous pipe stress							
Analysis Type: Rainflow							
Worst Damage							
Damage over Total Exposure	0.0142						
Total Exposure Time (years)	19.512						
Life (years)	1375.8						
Arc Length (m)	0						
Theta (deg)	0						
SN-curve	D Curve						
Radial Position	Outer						
SCF	1.2						
Thickness Correction Factor	1						

10. Wave Direction 270

Fatigue Damage Summary	
OrcaFlex 9.7a: fatigue 270.ftg (modified 20:49 on 27.04.2014 by OrcaFlex 9.7a)	
Title: fatigue result for wave direction 270 degree	
Damage Calculation: Homogeneous pipe stress	
Analysis Type: Rainflow	
Worst Damage	
Damage over Total Exposure	0.0061
Total Exposure Time (years)	12.314
Life (years)	2033.7
Arc Length (m)	0
Theta (deg)	0
SN-curve	C2 Curve
Radial Position	Outer
SCF	1.2
Thickness Correction Factor	1
Fatigue Damage Summary	
OrcaFlex 9.7a: fatigue 270.ftg (modified 20:49 on 27.04.2014 by OrcaFlex 9.7a)	
Title: fatigue result for wave direction 270 degree	
Damage Calculation: Homogeneous pipe stress	
Analysis Type: Rainflow	
Worst Damage	
Damage over Total Exposure	0.0089
Total Exposure Time (years)	12.314
Life (years)	1383.6
Arc Length (m)	0
Theta (deg)	0
SN-curve	D Curve
Radial Position	Outer
SCF	1.2
Thickness Correction Factor	1

11. Wave Direction 300

Fatigue Damage Summary						
OrcaFlex 9.7a: fatigue 300.ftg (modified 21:18 on 27.04.2014 by OrcaFlex 9.7a)						
Title: Fatigue result wave direction 300 degree						
Damage Calculation: Homogeneous pipe stress						
Analysis Type: Rainflow						
Worst Damage						
Damage over Total Exposure	0.0042					
Total Exposure Time (years)	8.4766					
Life (years)	2012.2					
Arc Length (m)	0					
Theta (deg)	0					
SN-curve	C2 Curve					
Radial Position	Outer					
SCF	1.2					
Thickness Correction Factor	1					
Fatigue Damage Summary						
OrcaFlex 9.7a: fatigue 300.ftg (modified 21:18 on 27.04.2014 by OrcaFlex 9.7a)						
Title: Fatigue result wave direction 300 degree						
Damage Calculation: Homogeneous pipe stress						
Analysis Type: Rainflow						
Worst Damage						
Damage over Total Exposure	0.0062					
Total Exposure Time (years)	8.4766					
Life (years)	1375.8					
Arc Length (m)	0					
Theta (deg)	0					
SN-curve	D Curve					
Radial Position	Outer					
SCF	1.2					
Thickness Correction Factor	1					

12. Wave Direction 330

Fatigue Damage Summary						
OrcaFlex 9.7a: fatigue 330.ftg (modified 22:43 on 27.04.2014 by OrcaFlex 9.7a)						
Title: fatigue result for wave direction 330 degree						
Damage Calculation: Homogeneous pipe stress						
Analysis Type: Rainflow						
Worst Damage						
Damage over Total Exposure	0.0048					
Total Exposure Time (years)	9.5703					
Life (years)	1987.2					
Arc Length (m)	0					
Theta (deg)	0					
SN-curve	C2 Curve					
Radial Position	Outer					
SCF	1.2					
Thickness Correction Factor	1					
Fatigue Damage Summary						
OrcaFlex 9.7a: fatigue 330.ftg (modified 22:43 on 27.04.2014 by OrcaFlex 9.7a)						
Title: fatigue result for wave direction 330 degree						
Damage Calculation: Homogeneous pipe stress						
Analysis Type: Rainflow						
Worst Damage						
Damage over Total Exposure	0.007					
Total Exposure Time (years)	9.5703					
Life (years)	1367					
Arc Length (m)	0					
Theta (deg)	0					
SN-curve	D Curve					
Radial Position	Outer					
SCF	1.2					
Thickness Correction Factor	1					

APPENDIX D – Orcaflex Software Description

D.1 Introduction

The following section will give the general description of the OrcaFlex software that is used in this thesis. The content of this section will be mainly based on the OrcaFlex Manual version 9.4a.

D.2 General Description about OrcaFlex

OrcaFlex is a marine dynamics program developed by Orcina for static and dynamic analysis of a wide range of offshore system, including all types of marine risers. The main analyses covered in this software are the global analysis, moorings, installation, and towed system analysis.

The software has several objects (i.e. Lines, Vessels, and Buoys) that can be built up and interconnected via special objects (i.e. Link, Winch, and Shape) to create a mathematical model of the system. Figure below shows the sample of 3D view capability and also the computer model in OrcaFlex.

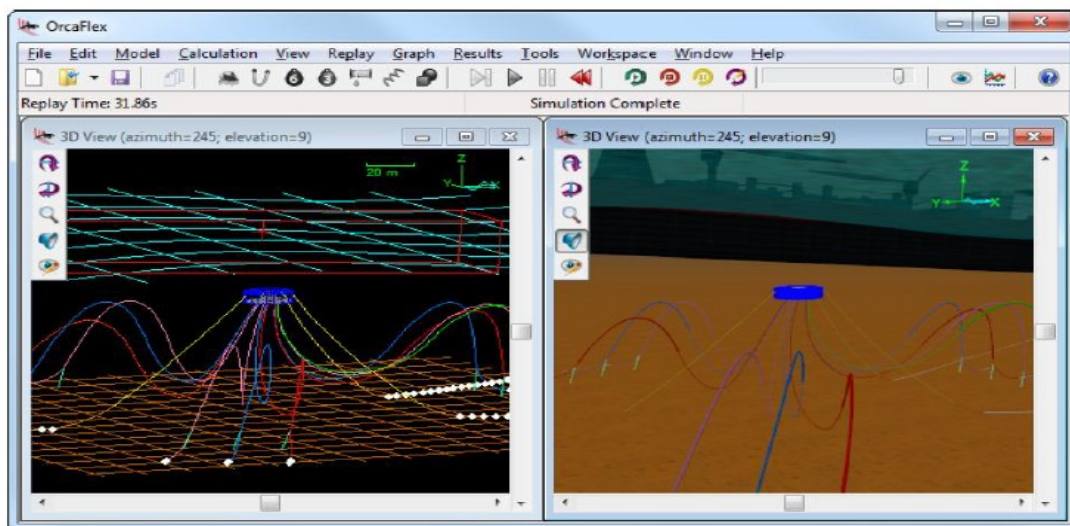

Figure D.1 – A 3D View OrcaFlex computer model (Orcina, 2010, page 52)



FigureD.2 – Object Menu (Orcina, 2010, page 46)

General sequence runs from static state, followed by dynamic simulation. The following diagram shows the sequence of states used and the actions.

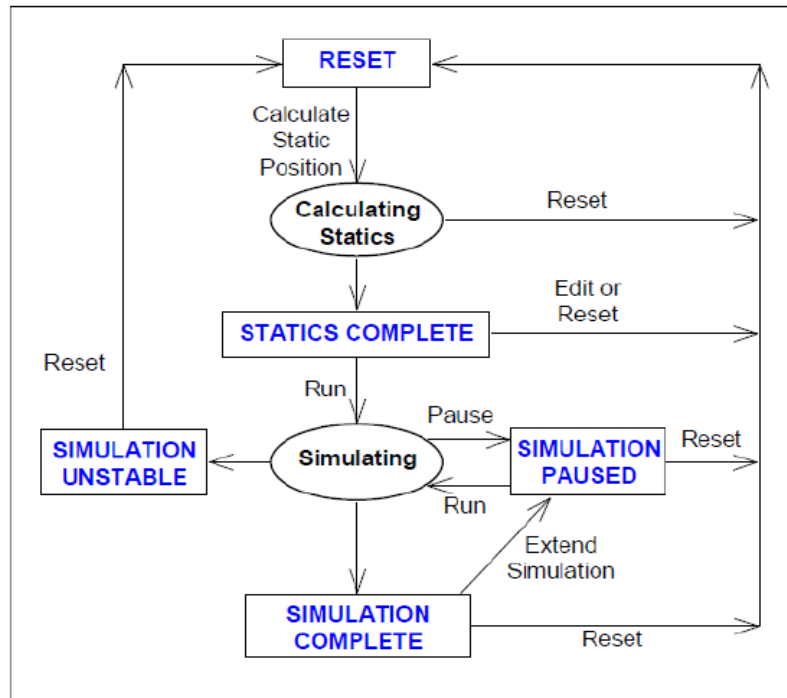

Figure D.3 – Sequential states of OrcaFlex (Orcina, 2010, page 26)

D.3 Coordinate System

There are two coordinate systems that used by OrcaFlex. They are global coordinate system (GX, GY, and GZ) and local coordinate system (x, y, and z). These coordinate systems are a right-handed system and normally its Z-axis is heading to the positive upwards.

The following figures show the description of the coordinate systems and the direction and heading conventions in OrcaFlex.

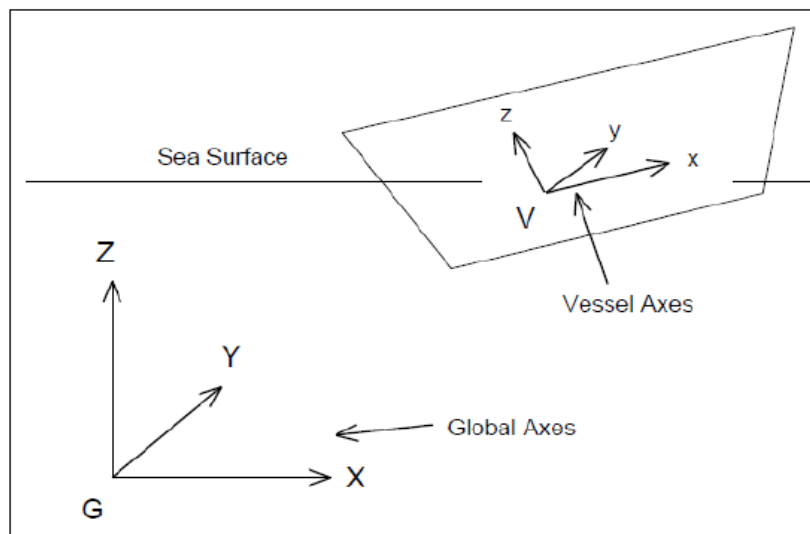

Figure D.4 – Coordinate system (Orcina, 2010, page 111)

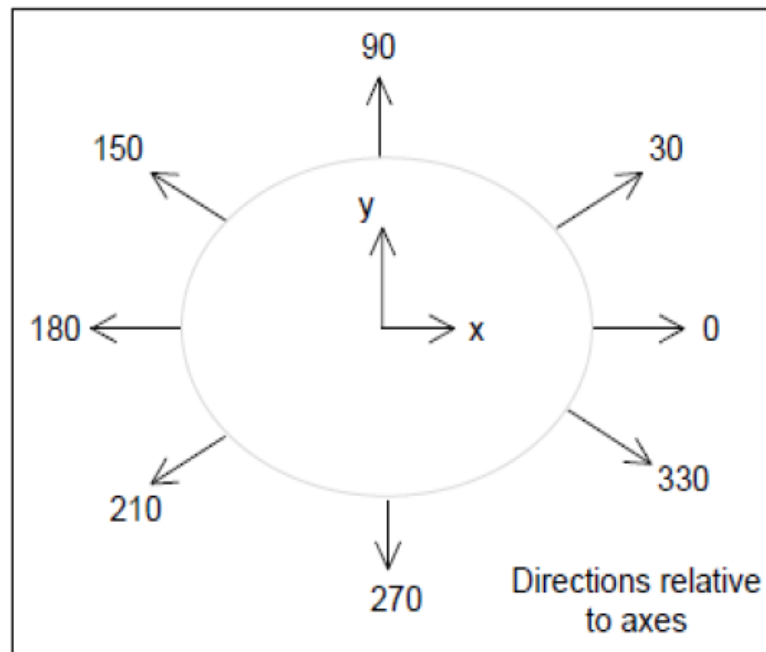

Figure D.5 – Directions and headings (Orcina, 2010, page 112)

D.3.1 Static and Dynamic Stage

D.3.2 Static Analysis

The static analysis provides the initial static equilibrium condition of the computer model, and it is used as a startup point for dynamic simulation. In summary, two objectives for a static analysis are:

1. To determine the equilibrium configuration of the system under weight, buoyancy, hydrodynamic drag, etc.
2. To provide a starting configuration for dynamic simulation

D.3.3 Dynamic Analysis

The dynamic analysis is a time simulation of the motions of the model over a specified period of time, starting from the position derived by the static analysis. The period of simulation is defined as a number of consecutive stages.

Before the main simulation stage, there is a build-up stage, during which the wave and vessel motions are smoothly ramped up from zero to their full size. This provides a gentle start and reduces the transients that are generated from static position to full dynamic motion. This build-up stage is numbered 0 and its length should normally be set to at least one wave period. Refer to below for details.

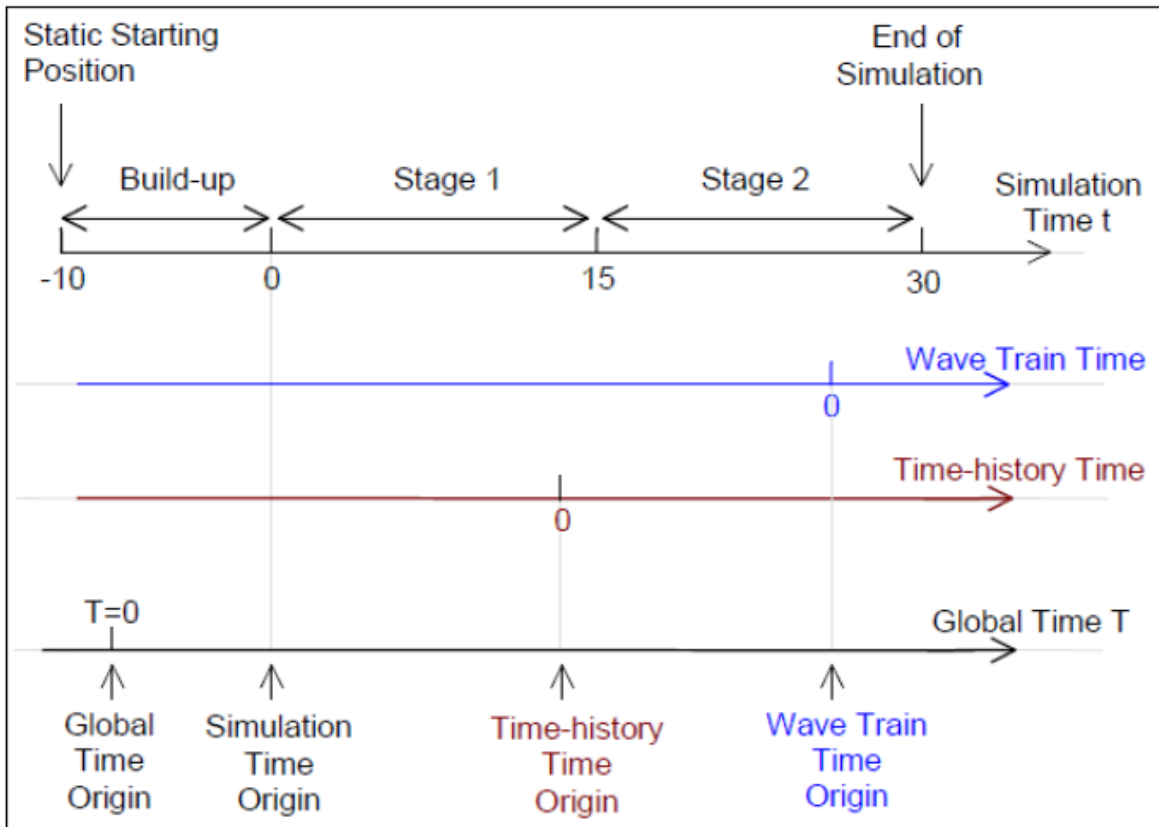

Figure D.6 – Time and simulation stages in dynamic analysis (Orcina, 2010, page 121)

D.4 Modeling

OrcaFlex uses a finite element model as the basic concept of modeling. For example, a single length of pipe can be discretized into several nodes and segments model. The following figure shows the general OrcaFlex line model.

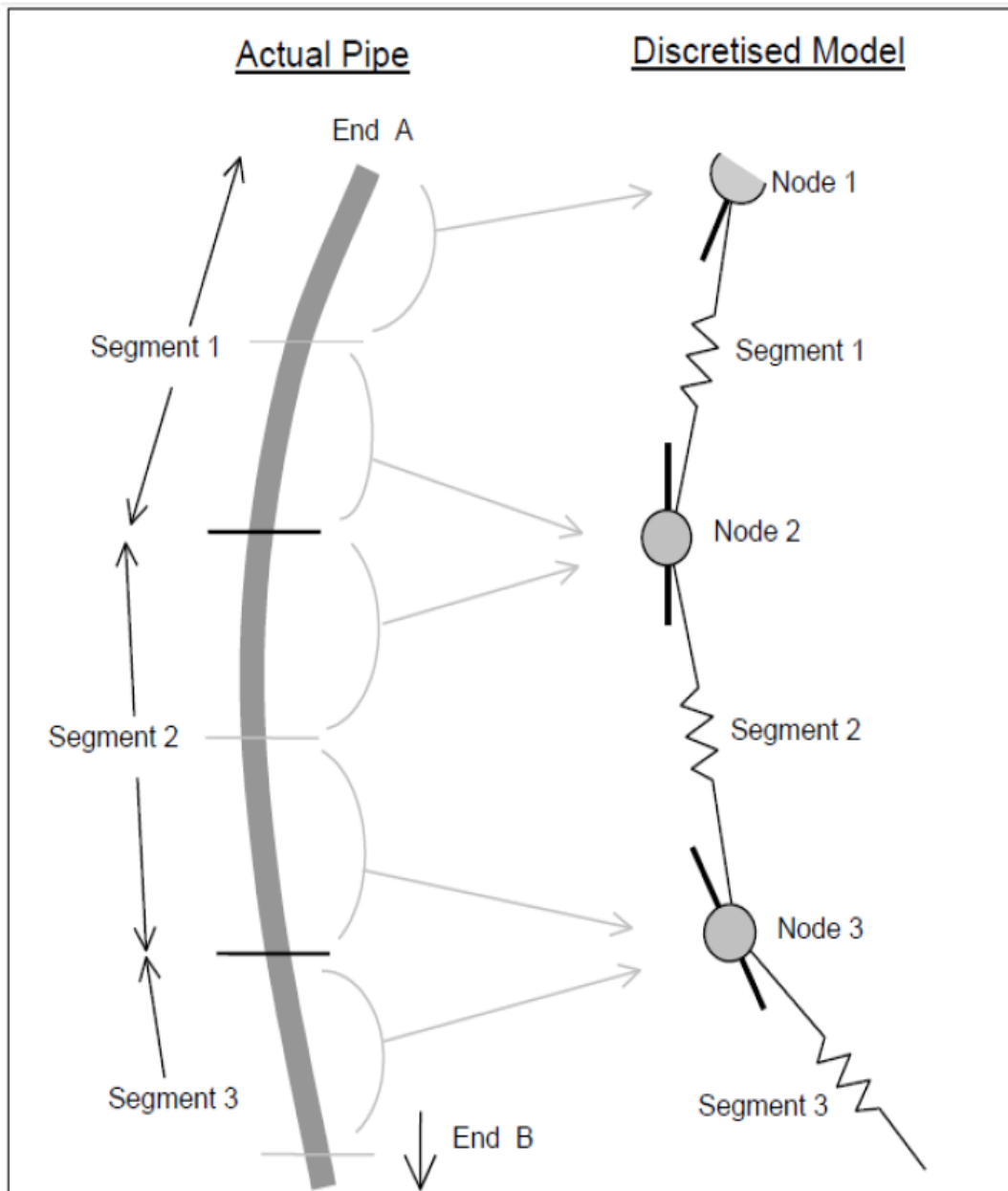

Figure D.7 – Line Model (Orcina, 2010, page 155)

Each node is effectively a short straight rod that represents the two segments either side of the node, except the end nodes, which have only half-segment next to them. Each line segment is divided into two halves and the properties (mass, weight, buoyancy, drag, etc.) of each half segment are lumped and assigned to the node at that end of the segment. Forces and moments are applied at the nodes.

Each segment is a straight massless element that models just the axial and torsional properties of the line. It can be thought as being made up by two co-axial telescoping rods that are connected by axial and torsional spring + dampers. The bending properties of the line are represented by rotational spring + dampers at each end of the segment.

The following figure shows structural detail of the line model.

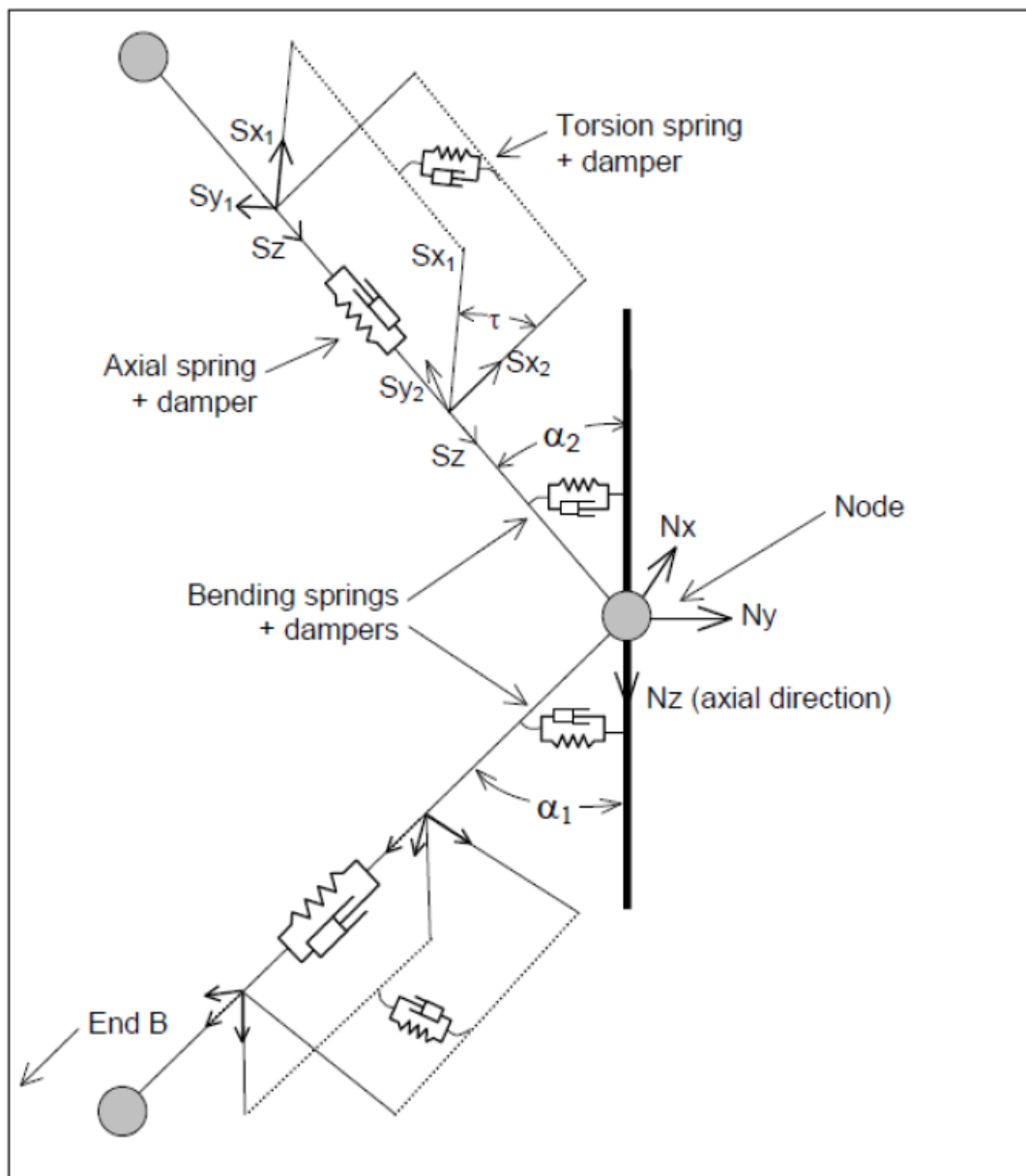

Figure D.8 – Detailed Representation of Line Model (Orcina, 2010, page 157)