



Universitetet
i Stavanger

FACULTY OF SCIENCE AND TECHNOLOGY

MASTER THESIS

| | |
|---|---|
| Study programme/specialisation: Biological Chemistry Organic Synthesis | Spring semester 2019 Restricted |
| Author: Dina Rolfsvåg |  (signature of author) |
| Programme coordinator: Eli Drange Vee Supervisor(s): Einar Bakstad | |
| Title of master's thesis: Investigation of Vinyl Ether Synthesis and Subsequent Application in Organic Synthesis | |
| Credits: 60 | |
| Keywords: Vinyl Ether Acetal Mesylate <i>Gem</i> -dihalocyclopropane Carbene Alkyne | Number of pages:59..... + supplemental material/other: ...4..... Stavanger.....13.06.2019..... date/year |

Titlepage for Master
Thesis Faculty of Science
and Technology

Acknowledgements

The constant encouragement, thought-provoking debates and involvement by my supervisor professor Einar Bakstad (Director of Research at Biolink group AS Laboratories) has made this master thesis not only possible but also a lot of fun. His insights and positivity has shaped me as a chemist and made me wish to pursue this career further.

I would like to thank Sjur Svaboe (Chairman of the board at Biolink Group AS), Kåre Svaboe (CEO at Biolink Group AS), Kristian Larsen (Board member at Biolink Group AS) for letting me use the laboratory at Hanabryggene Teknologisenter, and for providing me with the chemicals and equipment I needed for this MSc. The laboratory of the Biolink Group has given me the opportunity to learn both the theory and practical nature of organic chemistry, of which I am eternally grateful.

To my colleagues and friends, Ph.D. student, Jørn Holm Naimak and MSc. Jørgen Ledaal Dalva, a simple thank you is not enough. Jørn Holm Naimak has not only helped me when I asked for guidance but also aided me in giving suggestions for my chemistry that was extremely treasured. His positivity and abundant knowledge for both chemistry and politics has made every day at the lab enjoyable. Jørgen Ledaal Dalva gave great advice throughout my entire project and always lifted my spirits.

Additionally, a big thanks to Professor Kåre B. Jørgensen at the University of Stavanger for allowing me the use of their NMR, IR and MS instrument, and to Ph.D. students Katja Håheim and Vebjørn Eikemo for helping me with the instruments at UiS.

Finally, thanks to my family and boyfriend who have always motivated me and supported me in every decision I have made. I am incredibly lucky to have parents so loving who also have a great knowledge within science and medicine. Having so great rolemodels have pushed me to find the field that I love and pursue it with my whole heart.

Abstract

The standard method of synthesizing vinyl ethers from the elimination of an alcohol from an acetal was tested against synthesizing them through the elimination of a mesyloxy group. A total of seven different molecules were tested in both methods. For the first method only three of the vinyl ethers survived the technique, the rest polymerized. The second method worked with fair to good yields on all the molecules. The key synthetic strategies in the secondary method was the Corey-Chaykovsky reaction or the Prilezhaev reaction for epoxidation, regioselective ring opening with Lewis acid, a functional group interconversion, and an elimination.

Making acetylenes from vinyl ethers through a *gem*-dihalocyclopropane intermediate is a relatively unexplored pathway. Two members of the Bakstad research group, D. Maharjan and Y. Luijkx, have already investigated the synthesis of acetylenes using this pathway. In this thesis, only two vinyl ethers were additionally explored, and the reactions worked with fair yields giving the desired product. This carbene reaction could have great potential in synthesizing new molecules and aid in pharmaceutical production.

Robert H. Grubbs won the Nobel prize in 2005 in chemistry on his work on a metathesis catalyst.^[1] He found that metathesis on vinyl ethers lead to polymerization and thereby synthesized a ruthenium carbene complex catalyst that bypassed this issue. It is also of incredibly high interest that he introduced a strong σ -donating NHC to obtain a second catalyst with higher activity. His work and the acknowledgement he got for it summarizes the importance of vinyl ethers, avoiding polymerization and the interesting effects of carbenes. All of which are essential points in this thesis.

From the work in this thesis 17 novel molecules have been synthesized. According to the authors best knowledge compounds **8**, **10**, **11**, **15**, **38**, **39**, **40**, **45**, **46**, **47**, **48**, **49**, **51**, **52**, **54**, **55** and **56** have not been prepared before. The novel vinyl ethers synthesized are depicted in Figure 1.

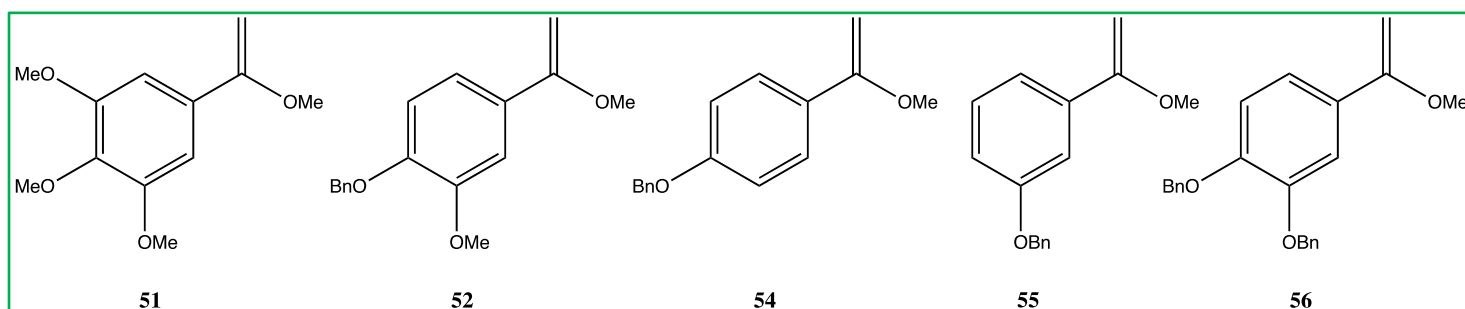

Figure 1. Novel Vinyl Ethers synthesized.

Selected Abbreviations

| | |
|-----------------------|--|
| Ar | Aryl |
| ATR | Attenuated total reflectance |
| atm | Atmosphere |
| CER-MOP | Cerium (IV)sulphate, molybdate phosphoric acid |
| DCM | Dichloromethane |
| DME | 1,2-Dimethoxy ethane |
| DMF | <i>N,N</i> -Dimethylformamide |
| DMSO | Dimethyl Sulfoxide |
| DNA | Deoxyribonucleic acid |
| DFC | Dry flash chromatography |
| EDG | Electron donating group |
| ESI | Electrospray ionization |
| EWD | Electron withdrawing group |
| FC | Flash chromatography |
| FTIR | Fourier transform infrared spectroscopy |
| Hz | Hertz |
| h | Hour |
| IR | Infrared spectroscopy |
| LRMS | Low-resolution mass spectrometry |
| <i>m</i>-CPBA | <i>Meta</i> -chloroperoxybenzoic acid |
| MOP | Molybdate phosphoric acid |
| NHC | <i>N</i> -heterocyclic carbene ligand |
| NMR | Nuclear magnetic resonance |
| S_NA | Nucleophilic aromatic substitution |

| | |
|-----------------------------|---------------------------------|
| TEBA | Triethylbenzylammonium Chloride |
| THF | Tetrahydrofuran |
| TLC | Thin-layer chromatography |
| TMS | Tetramethylsilane |
| PFA | Paraformaldehyde |
| PE | Petroleum ether |
| PET | Positron Emission Tomography |
| PTC | Phase transfer catalyst |
| <i>R_f</i> | Retardation factor |
| rt | Room temperature |
| UV | Ultra violet |

Table of Contents

| | |
|--|-----------|
| ACKNOWLEDGEMENTS | 2 |
| ABSTRACT | 3 |
| SELECTED ABBREVIATIONS | 4 |
| 1. INTRODUCTION | 7 |
| 1.1 OBJECTIVES..... | 7 |
| 1.2 VINYL ETHERS..... | 8 |
| 1.2.1 Synthesis of Vinyl Ether using Wittig | 8 |
| 1.2.2 Synthesis of Vinyl Ether using a Palladium Coupling | 9 |
| 1.2.3 Synthesis of Vinyl Ether from Acetals..... | 9 |
| 1.2.4 Synthesis of Vinyl Ether from Elimination of Halogens..... | 10 |
| 1.2.5 Synthesis of Vinyl Ether from Elimination of Mesylate | 11 |
| 1.2.6 The Selected Methods for Vinyl Ether Synthesis | 12 |
| 1.3 GEM-DIHALOCYCLOPROPANES..... | 13 |
| 1.3.1 Synthesis of Gem-dihalocyclopropanes | 13 |
| 1.4 CARBENES..... | 14 |
| 1.4.1 Carbenes in Medicine | 14 |
| 2. RESULTS AND DISCUSSION | 17 |
| 2.1 SYNTHESIS OF VINYL ETHERS - METHOD 1 | 17 |
| 2.1.1 Transforming Acetophenones to Acetals through Acid Catalysis | 17 |
| 2.1.2 Transforming Acetals to Vinyl Ethers through Distillation..... | 19 |
| 2.1.3 Total Yield for Method 1 | 22 |
| 2.2 SYNTHESIS OF VINYL ETHERS - METHOD 2 | 23 |
| 2.2.1 Aldehyde Epoxidation with the Corey-Chaykovsky Reaction | 23 |
| 2.2.2 Styrene Epoxidation using the Prilezhaev Conditions | 25 |
| 2.2.3 Transforming Epoxides to Methoxy Alcohols by Lewis Acid | 28 |
| 2.2.4 Substitution of a Methoxy Alcohol into a Mesylate..... | 30 |
| 2.2.5 Elimination of Mesylates to Synthesize Vinyl Ethers..... | 31 |
| 2.2.6 Total Yield for Method 2 | 33 |
| 2.3 SYNTHESIS OF ACETYLENIC ACETAL FROM METHYL GLYOXAL ACETAL..... | 34 |
| 2.4 CONCLUDING REMARKS AND FUTURE WORK..... | 37 |
| 3. EXPERIMENTAL | 39 |
| 3.1 GENERAL | 39 |
| 3.1.1 Solvents and reagents..... | 39 |
| 3.1.2 Spectroscopic and Physical analysis..... | 39 |
| 3.1.3 Chromatography..... | 39 |
| 3.2 METHODS..... | 40 |
| 3.2.1 Synthesis of various acetophenones. | 40 |
| 3.2.2 Synthesis of acetals. | 41 |
| 3.2.3 Synthesis of benzylated compounds. | 43 |
| 3.2.4 Synthesis of epoxides. | 45 |
| 3.2.5 Synthesis of methoxy alcohols. | 47 |
| 3.2.6 Synthesis of mesylates. | 49 |
| 3.2.7 Synthesis of vinyl ethers. | 51 |
| 3.2.8 Synthesis of 2-alkoxy-1,1-dichlorocyclopropanes. | 54 |
| 3.2.9 Ring opening of 2-alkoxy-1,1-dichlorocyclopropanes..... | 55 |
| 4. REFERENCES | 56 |
| 5. APPENDIX | 60 |
| 5.1 STRUCTURES | 60 |

1. Introduction

1.1 Objectives

Vinyl ethers are important building blocks for organic synthesis as they aid in the synthesis of complex as well as simple molecules. Finding new ways in which these fundamental molecules are synthesized can aid researchers, especially if these methods give a higher yield, a better economic benefit, have fewer steps or are more aimed at industrial manufacture. The synthesis of these molecules today has problems with polymerization, efficiency or regioselectivity.

Two methods for synthesizing vinyl ethers will be tested in this thesis. Firstly, a widely utilized two-step method involving an acetal intermediate. Secondly, a novel synthesis involving the elimination of a mesyloxy group. To the authors best knowledge, this approach has not been explored in regard to vinyl ether synthesis. The generation of the mesylate and vinyl ether is done through two pathways. The Corey-Chaykovsky reaction was used on aldehydes to synthesize epoxides, the Prilezhaev reaction conditions were used on styrenes to oxidise them to epoxides. From here, a regioselective ring opening, substitution of the alcohol function with mesylate and finally an elimination. The second method therefore has four steps to synthesize vinyl ethers.

Additionally, carbenes have recently been seen frequently in medicinal studies and have a high impact factor. Therefore, looking into how these molecules can react is of great importance. The Makosza method will be used on vinyl ethers to synthesis *gem*-dihalocyclopropanes and concomitantly, acetylenes.

The aim of this study is to examine two ways of synthesising vinyl ethers as well as exploring how carbenes react with these vinyl ethers. A summary of the goals of this thesis is shown in Schemes 1 and 2.

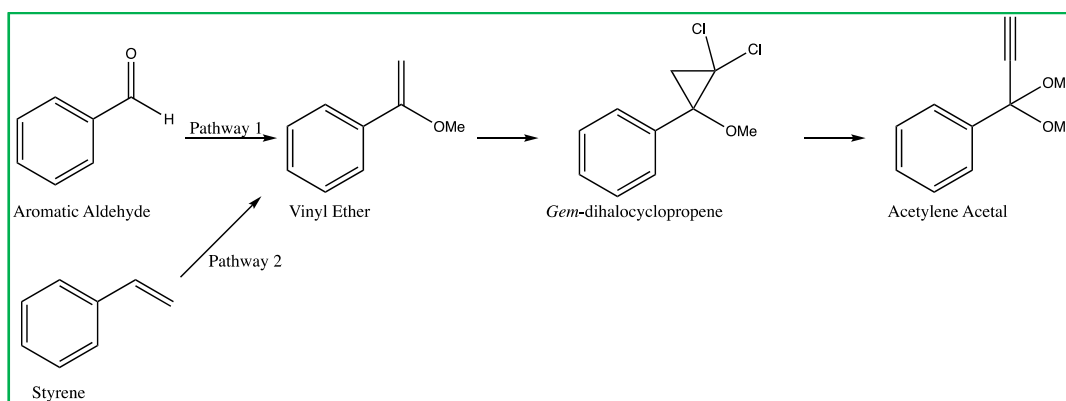
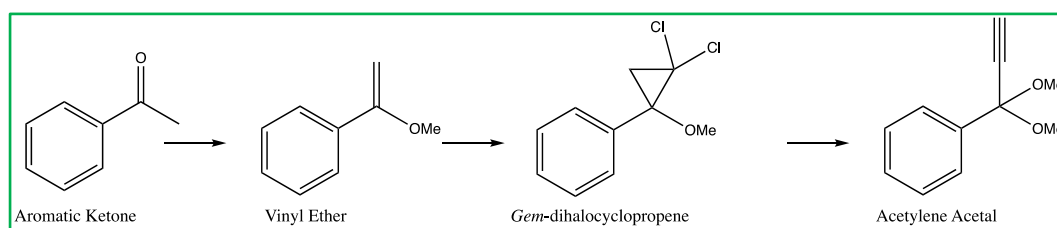

1.2 Vinyl Ethers

Vinyl ethers were originally thought of as derivatives of aldehydes and ketones.^[2] Over time however, their properties in cycloadditions to olefins,^[3] aliphatic Claisen reactions^[4] and their ability to form anions^[5-7] made vinyl ethers very remarkable. Currently, the vinyl ether is even considered to be an activated double bond due to the oxygen's electrons conjugating towards the double bond, making an oxonium resonance form.

Vinyl ethers, originally with trimethylsilyl (TMS), also works with high efficiency in the Rubottom reaction.^[8] This reaction is used to synthesize α -hydroxy ketones, also called acyloins, which are an essential part of for example anthocyanin synthesis. The reaction mechanism proposed by Rubottom himself is displayed in Scheme 3 and is highly interesting especially regarding the silicon migration.^[9]

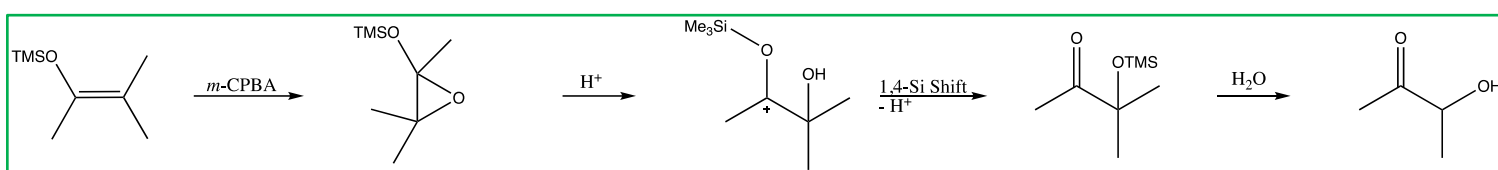

Scheme 3. Rubottom oxidation mechanism.^[9]

Additionally, one of the most famous pericyclic reactions in organic chemistry, the Diels Alder reaction, can be performed with vinyl ethers. One example is Danishefsky's diene, which has double vinyl ether functionality is incredibly electron rich and therefore a very reactive diene in a Diels Alder reaction.^[10]

All of these applications leaves no doubt that vinyl ethers are essential in organic synthesis and optimising their synthesized is of central magnitude.

1.2.1 Synthesis of Vinyl Ether using Wittig

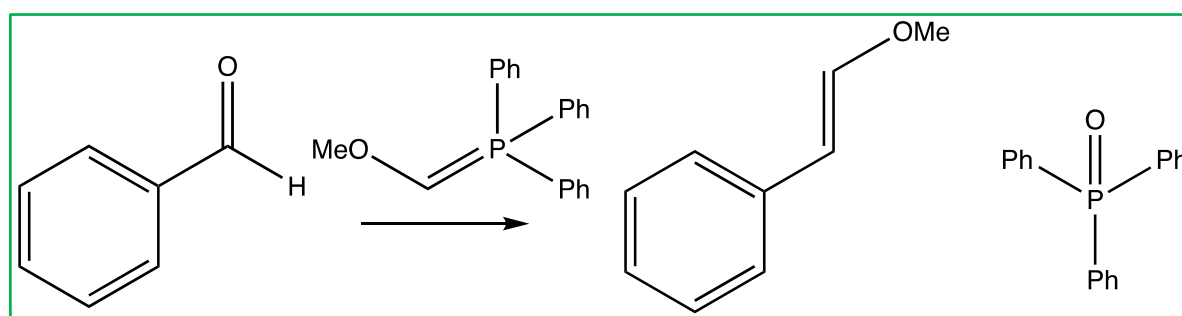

Scheme 4. Wittig reaction to transform an aldehyde into a vinyl.^{[11] [12]}

The first thought regarding synthesizing vinyl ethers could be using the Wittig reaction to transform an aldehyde into a vinyl ether in a single step (Scheme 4).^[11 - 12] However, this reaction gives the non-terminal vinyl ether. In this thesis it is the terminal vinyl ether that is the desired product, alternate approaches should therefore be considered regarding the synthesis of terminal vinyl ethers.

1.2.2 Synthesis of Vinyl Ether using a Palladium Coupling

Stannylcupration of ethynyl ethyl ether can also be utilized to synthesize vinyl ethers through palladium catalysis. The Kwon group has used this method to produce stannyl vinyl ether.^[13] The biggest drawbacks from using this method is the major difficulty in synthesizing the starting ether as well as the method exhibits less regioselectivity. The Kwon group does not state the relationship between the two products obtained and it is therefore possible that the terminal vinyl ether is the major product. To conclude, although they had a yield of 95% on their final step, it is still somewhat questionable in regard to other methods.

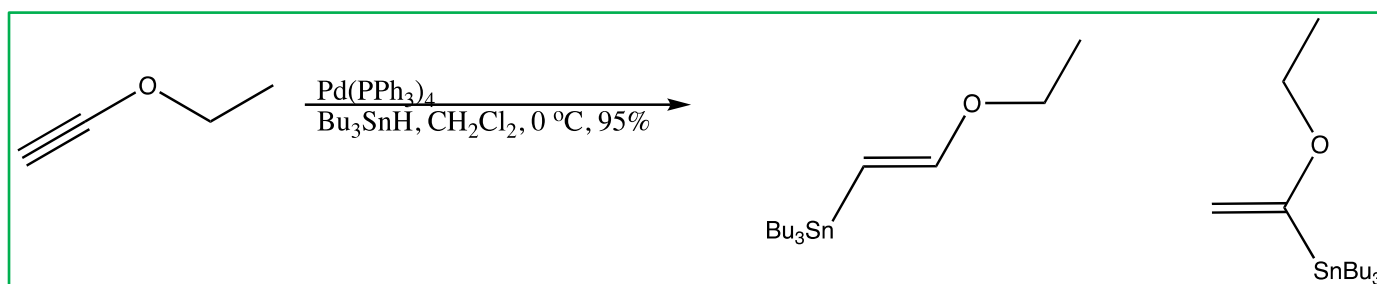

Scheme 5. Palladium coupling reaction according to the Kwon conditions.^[13]

The palladium coupling reaction can be seen in Scheme 5 showing the two possible vinyl ethers that are synthesized using this method. This thesis is focused on vinyl ethers with both their R groups on one side of the double bond (terminal). Therefore, only one of the products here is of interest. The lack of regioselectivity of this approach could therefore be a fundamental problem.

1.2.3 Synthesis of Vinyl Ether from Acetals

Transforming a carbonyl moiety into a vinyl group can be achieved in two steps (Scheme 6). First by making an acetal^[14] then subsequently adding acid and pushing the equilibrium towards a vinyl product.^[15] This method has been seen to work in fair to good yields but it has risk of polymerization. M. F. Shostakovsky discovered already in 1953 that acetals polymerized when heated with an acid catalyst.^[16]

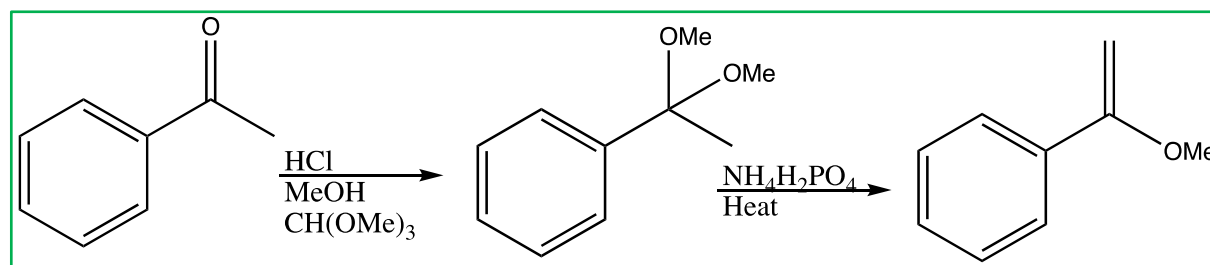

Scheme 6. The two-step synthesis of transforming a ketone to a vinyl ether.^{[10][11]}

Some of the factors for the initiation of polymerization of vinyl ethers are radicals and cations such as Friedel-Craft catalysts.^[17-18] It is highly interesting that vinyl ethers are markedly stable towards peroxides, but violently polymerize under acid-type catalysts.^[19] To be capable of eliminating methanol from the acetal a weak acid is required, creating a risk of the vinyl group

initiating polymerisation. Additionally, to push the equilibrium towards the vinyl ether, the methanol is removed by distillation at high temperatures. This high temperature is necessary due to the high activation energy required in this reaction. So, although methanol has a relatively low boiling point, temperatures of up to 170 °C was needed in the oil bath for the reaction to occur. Furthermore, the solubility of vinyl ether polymers is non-existent which means that not only does the reaction have a considerable chance of failing, but it can also leave a undesirable mess.

1.2.4 Synthesis of Vinyl Ether from Elimination of Halogens

As far as the researcher is aware, only two examples of elimination reactions involving halogens are described in literature. Both give excellent yields and have few steps involved to give the desired product.

From the iodo compound the halogen, iodine, has been eliminated using sodium methoxide in 1955. S. Winstein found that the iodo complex gave an unsubstituted aromatic vinyl ether with a yield of 95% (Scheme 8).^[20] Winstein synthesized his iodo compound with mercury, which is highly toxic. Therefore, an alternate approach is the research of M. K. Agrawal which uses KI/KIO₃ and methanol to synthesize the compound (Scheme 7).^[21]

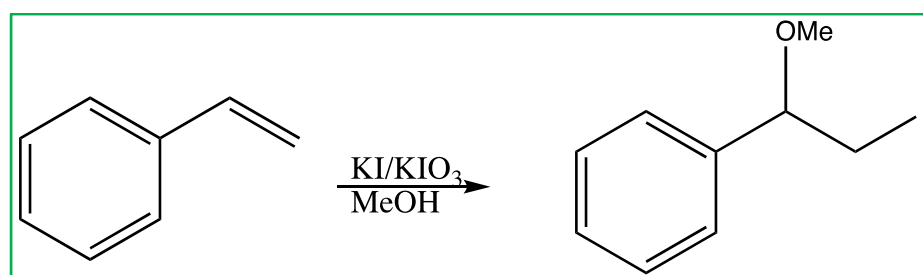

Scheme 7. The synthesis of an iodine compound from a styrene.^[21]

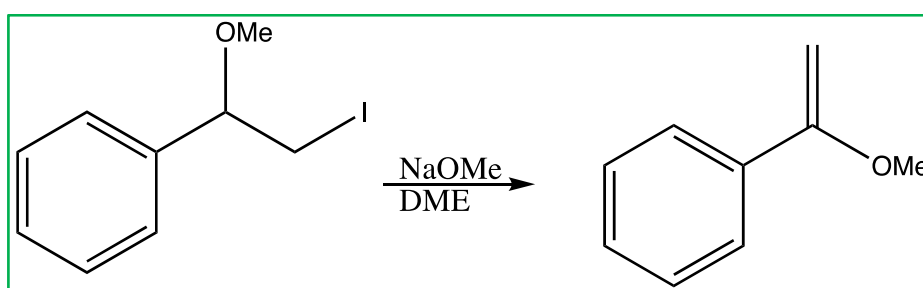

Scheme 8. The elimination of iodine to form a vinyl ether.^[20]

Previous work by the Bakstad research group was inspired by the Winstein method. Using Winstein's elimination method vinyl ethers were prepared with a yield in the range of 52-65% by master student Yvette Luijckx^[22] and 82-95% by master student Dilita Maharjan^[23] respectively. The researchers used potassium *tert*-butoxide (*t*-BuOK) as a base instead of methoxide to gain these results. Considering these promising yields, the iodine elimination seems to also be an excellent method to synthesize vinyl compounds. However, it is still of interest to find the leaving group that will give the utmost ideal results with these significant molecules.

Elimination of bromine has also been done by L. David and colleagues to prepare vinyl ethers with an extremely high yield (95%).^[24] Here sodium amide was used as base. The results from S. Winstein, D. Maharjan, Y. Luijckx and L. David indicate that multiple bases can be used to acquire high yields from these type of elimination reactions.

These two methods afford very high yields and can effectively be synthesized in two steps from a styrene, several of which are commercially available. These findings indicate that a leaving group could be the essential way of synthesizing vinyl ethers.

1.2.5 Synthesis of Vinyl Ether from Elimination of Mesylate

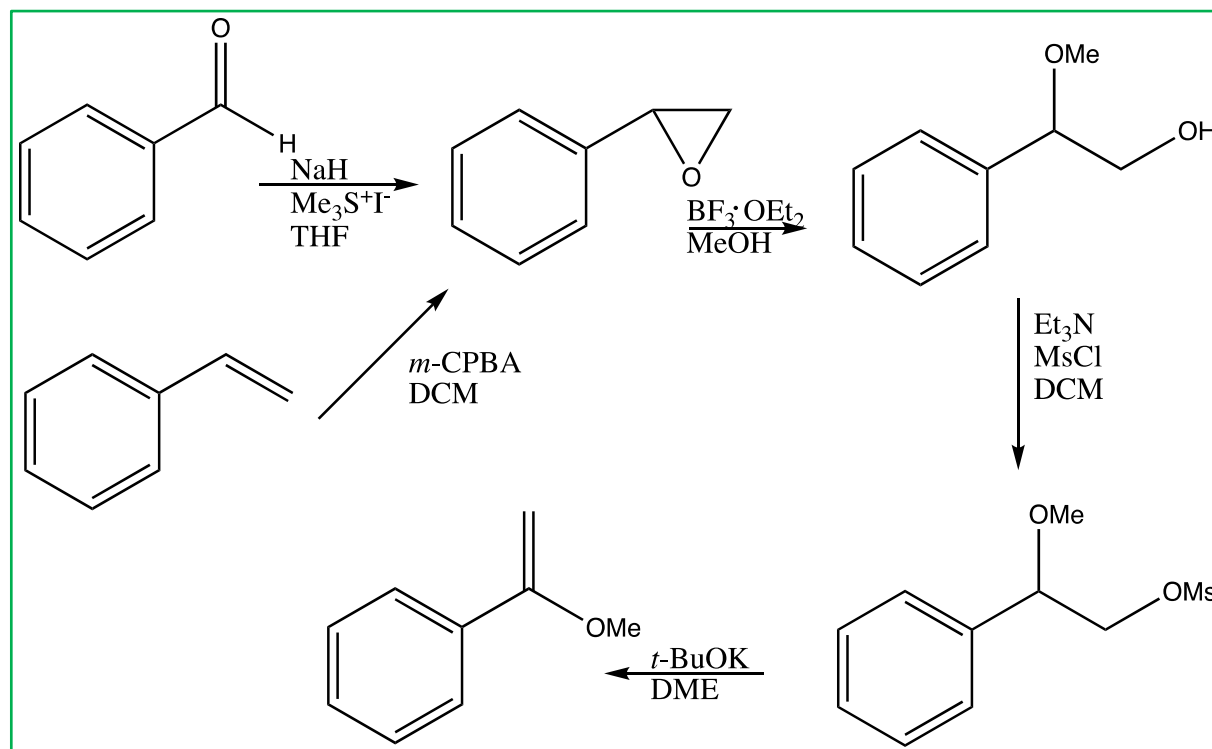

Scheme 9. The four-step synthesis of Vinyl ethers from styrene and aldehyde starting products. The Corey-Chaykovsky reaction^[25] and Prilezhaev reaction formed epoxides^[26], Lewis acids ensured for regioselective ring opening^[27], mesyl chloride was substituted with the alcohol function using Tipson conditions^[28] and finally the mesyloxy group was eliminated.

The mesyloxy group is well known for its uses as a leaving group due to the weak bond between the oxygen and the R group attached. However, as far as the researcher is aware, it has not been used to make vinyl ether compounds. This is very interesting because reactions involving mesyloxy elimination tend to have great yields and work at low temperatures. It is also worthy of note that methane sulfonyl chloride is a cheaper chemical than the iodo (KI/KIO₃) and bromo (LiBr) compounds.

Exploring how these mesylates can produce vinyl ethers could potentially be the solution to the polymerization problem that chemists have had for decades. The heated acidic environment is switched with a reaction that can be conducted in room temperature with a basic environment. The Bakstad research team has composed a four-step reaction pathway, Scheme 9, that will explore the efficiency of the mesyloxy function as a leaving group.

The first step is two parted, either it was accomplished using the Corey-Chaykovsky reaction.^[25] In this reaction an epoxide is made from an aromatic aldehyde. The other pathway was the Prilezhaev reaction, where a styrene is oxidized to an epoxide.^[26] The aldehydes and styrenes are good starting materials because of their cheap nature and availability.

The second step involves the epoxide regioselectively being ring opened to give a methoxy compound on carbon 1, and an alcohol function on carbon 2. By using methanol and a Lewis acid such as $\text{BF}_3 \cdot \text{OEt}_2$ this is easily obtained. This method has been explored by K. Tanaka and colleagues and a yield up to 95% was obtained on 2-methoxy-2-phenylethyl methanesulfonate (**43**).^[27]

Thirdly, this alcohol function can be replaced with a mesyloxy function using methane sulfonyl chloride following the Tipson procedure.^[28] These reactions generally have a high yield in the range of 85-95%.

Finally, the mesyloxy can be eliminated using base, giving a vinyl ether in hopefully at least moderate to great yields. Based on other eliminations using mesylchloride it is a valid assumption that these reactions will succeed in similar manners. Such eliminations usually have yields in the high 90 range.^[29]

It is however worth noting what researchers R. Ding and colleagues found when investigating tosylates.^[30] They found that when an alcohol was treated with tosyl chloride it did not always result in the corresponding tosylate. Rather, the chlorine had substituted with the alcohol function. This is highly interesting and it should be kept in mind that the same results could be seen in mesyl chloride transformations.

1.2.6 The Selected Methods for Vinyl Ether Synthesis

Both the generation of vinyl ethers through an acetal and the exploration of the elimination of mesyloxy are chosen as the primary techniques of focus in this thesis.

All of the reactions in the elimination method have seemingly excellent yields and there is no longer a known danger of polymerization as there is in the acetal method. So, for these highly reactive compounds such an elimination could be the absolute ideal way to synthesize them.

Both the methods will be explored using similar aromatic compounds to investigate the most efficient, safe and economical approach for the synthesis of vinyl ethers.

Vinyl ethers are extremely versatile and can be used for many reactions, this includes carbene reactions. The next step with these molecules would be to react them with electrophilic carbenes in such a way as to make *gem*-dihalocyclopropanes and ring opening them to synthesize alkynes. It is interesting to investigate this method of making alkynes from vinyl ethers because of its significance not only to researchers but also in medicine for their physiological functions.

1.3 Gem-dihalocyclopropanes

Halogenated cyclopropanes have become an important part of organic chemistry.^[31] They are available from a wide range of substrates in good yields, as well as they are involved in a multitude of transformations. Thermal ring opening,^[32] allene formation^[33] and reductive dehalogenation^[34] are some of the reactions that halogenated cyclopropanes are involved in. Of importance, these molecules also play a part in base-induced elimination using alkoxides. When changing the reaction conditions or the substituents in the ring, the product changes from a β -elimination to produce a cyclopropene^[35] into alkylidene cyclopropanes^[36 - 38] and cyclopropabenzene instead.^[39]

1.3.1 Synthesis of Gem-dihalocyclopropanes

Alkenes with an alkoxy group function in an addition reaction with dihalocarbenes.^[40] Making these substituted alkenes are of interest. Two of the most common synthetic pathways are shown in Scheme 10.

In 1954 W. E. Doering and A. K. Hoffmann revolutionized chemistry when publishing their general synthesis of *gem*-dihalocyclopropanes. In this method, a dihalocarbene was generated from chloroform by α -elimination promoted by potassium *tert*-butoxide under anhydrous conditions.^[41] The Doering Hoffmann method has been seen to have fair to good yields and might be the ideal condition for these kinds of carbene reactions even today. Dibromocarbene addition to methoxyethene gives the corresponding cyclopropane with 58% yield when using the Doering Hoffmann method.^[42] Even when there are multiple alkyl groups attached to the double bond then the Doering Hoffmann reaction gives fair yields^[43 - 44].

In 1969 a new method for the development of cyclopropanes was proposed by M. Makosza. Here, a two-phase system was used, and the greatest difference is that the reaction no longer required anhydrous conditions. Here, the dichlorocarbene is made by adding a 50% aqueous solution of sodium hydroxide (NaOH) to chloroform with triethylbenzylammonium (TEBA) as the phase-transfer catalyst (PTC).^[45] This cheap but efficient chemistry has made carbene chemistry possible on a large, and even industrial, scales.

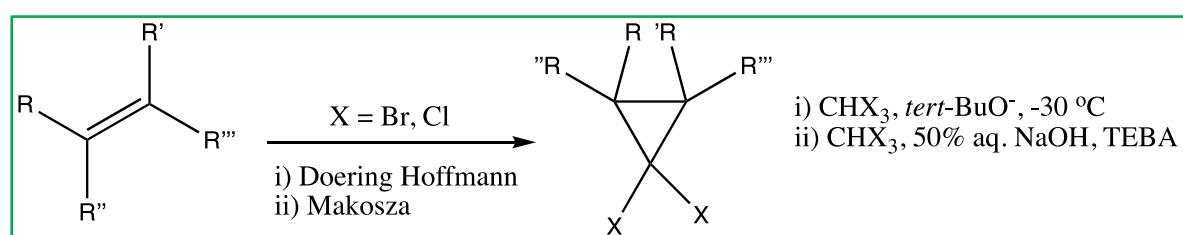

Scheme 10. Gem-dihalo cyclopropanation by Doering Hoffmann^[41, 46] and Makosza^[45] methods.

Although the Doering Hoffmann reaction has been seen to give advantageous yields, the Makosza reaction is so cheap and efficient, as well as it works in a hydrous environment. Therefore, the Makosza reaction will be used in regard to the initial exploration of vinyl ethers and their reactions with carbenes.

1.4 Carbenes

In the family of reactive intermediates; carbenes are of great importance. They are classified by having two unshared valence electrons and can react both as a nucleophile and electrophile. This makes them of interest in insertion, addition and dimerization reactions^[47].

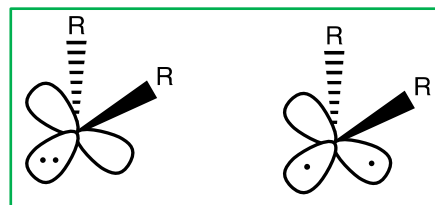

Figure 2. Singlet and triplet carbenes with two electrons in p orbitals.

There are two distinct configuration states for carbenes. The difference between singlet and triplet carbenes are in the placement of the two valence electrons. Whether they are in the same sp^2 (singlet) orbital or in separate p (triplet) orbitals, this can be seen in Figure 2. The singlet carbene has a spin value of zero while the triplet carbene has a spin value of one. The carbenes also have distinctive states where they are most stable, the singlet carbene is most stable in an aqueous state whilst the triplet carbene is most stable as a gas phase.

1.4.1 Carbenes in Medicine

Carbenes have recently been seen in medicinal studies and technology. The main carbenes of interest in the medicinal field have been N -heterocyclic carbenes (NHCs), but there is a general growing interest in the function and activity of carbenes. The three general structures of NHCs are displayed in Figure 3.^[48]

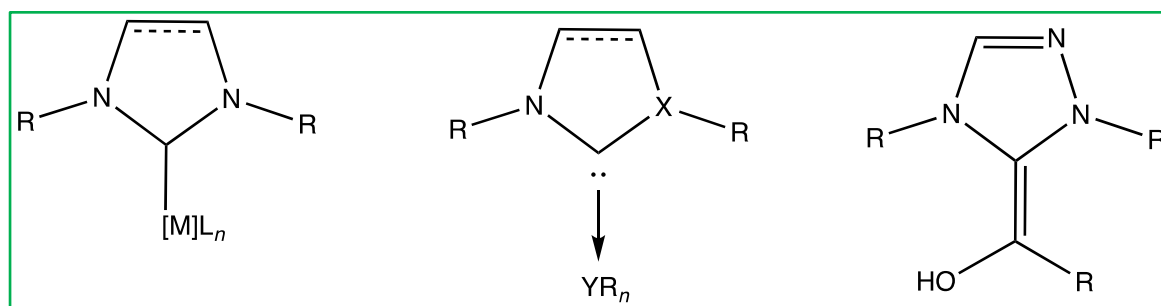

Figure 3. The three major NHCs.^[48]

N -Heterocyclic carbene ligands have been seen to bind to amyloid plaques of Alzheimer's disease^[49]. When the carbene ligand is bound to an isotope emitting fluorescence these amyloid plaques can be visualized using a positron emission tomography (PET) scan. This can revolutionize the field by bringing earlier diagnosis as well as having a diagnostic tool other than considering symptoms and progression. These types of carbenes have also been seen to selectively bind to mismatched deoxyribonucleic acid (DNA) which can highlight cancer cells from healthy cells furthermore leading to a new diagnostic tool that can aid in diagnosis and therapy.^[50]

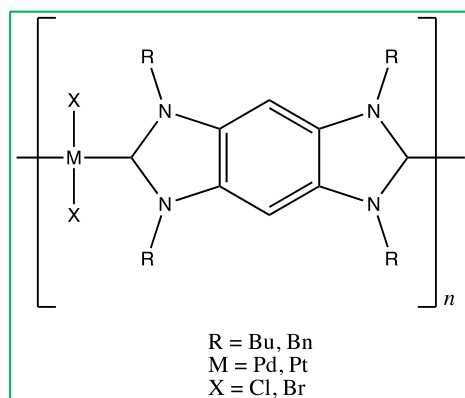

Figure 4. Metal NHC complex.^[48]

The incorporation of NHC metal complexes (Figure 4) into polymers have been studied to find interesting effects.^[48] The reversibility of the metal-ligand coordination shows self-healing properties in the polymers, as well as increased electrical conductivity, antibacterial, anticancer properties and some can even act as phosphors.

NHC-metal species featuring gold show significant promise as anticancer drugs because of their targeting of the mitochondria.^[51 - 52] Anticancer activity is highly reliant on interaction with the mitochondrial membrane, therefore being able to adjust the lipophilicity through modification of the *N*-substituents (Figure 5) on the NHC is essential.

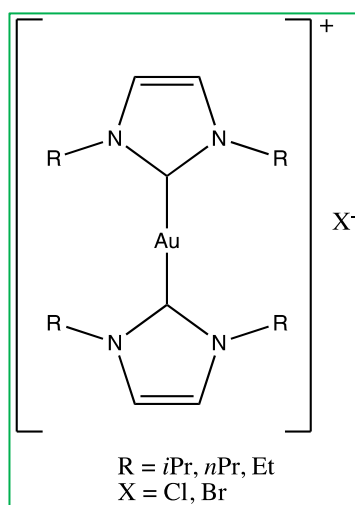

Figure 5. Gold NHC complex found to have anticancer effects.^[48]

Sandtorv and colleagues found that NHC silver complexes were potently cytotoxic towards two types of human leukaemia cells.^[53] Similarly, NHCs were tested on lung, breast and ovarian tumour cell lines by Kankala and colleagues to find that they had a high growth inhibition on these cancer cells.^[54] This was further supported by other studies that concluded that NHCs inhibited growth and were cytotoxic against human cancer cell lines by inducing oxidation of thioredoxins.^[55 - 56] Changing the structure of the NHC has an impact on the anticancer activity, the amount of phenyl groups has been found to be positively correlated to increased activity^[57].

Finally, carbenes have also recently been seen in research in the field of cystic fibrosis. At present, the best therapy technique involves polyfunctional nanocarriers with both antibacterial action against gram-positive bacteria and gene transfer into eukaryotic cells. In 2018, a study was carried out where NHCs were combined with the nanocarriers, and this extended the antibacterial activity including against some gram-negative bacteria.^[58]

All this research has indicated that carbenes are of great interest in the medicinal field and have possible revolutionary effects on devastating diseases.

1.7 Alkynes

Sydnés and Bakstad found a method for synthesizing alkynes from *gem*-dihalocyclopropanes.^[59] Scheme 11 shows the reaction proposed. They obtained yields ranging from 50 - 80%.

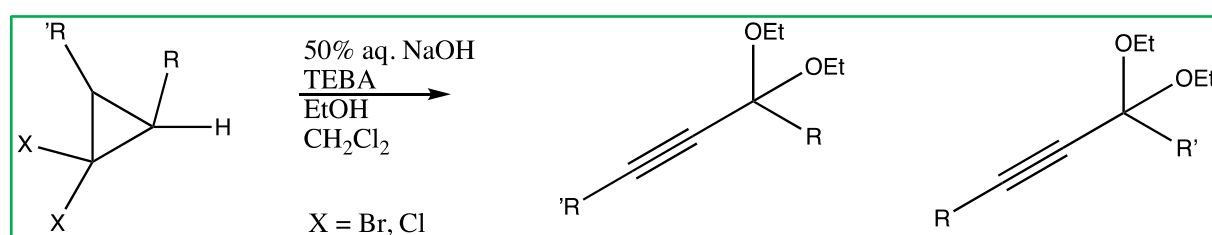

Scheme 11. The acetylenic acetal synthesized from a *gem*-dihalocyclopropane, according to Sydnés and Bakstad.^[59]

The reaction of vinyl ether to alkyne could potentially be done in a single step, but *gem*-dihalocyclopropane can be isolated as the transitional molecule.

Alkynes are often present in drugs because the triple bonds make the molecule more active, less toxic and more easily absorbed than the corresponding alkanes or alkenes.^[60] Two drugs that have an alkyne functionality is 3-methyl-pent-1-yn-3-ol^[61] which is used as a sleeping medicine (Figure 6), and cloccental^[62] (Figure 7), which is a carbamate-derived sedative hypnotic.

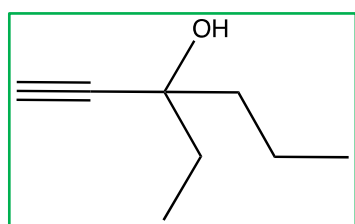

Figure 6. 3-Methyl-pent-1-yn-3-ol.

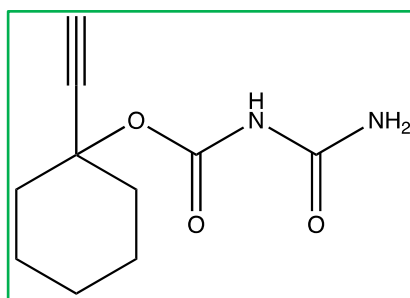

Figure 7. Cloccental.

Alkynes are also used for tagging molecules, as they are Raman-active with a distinct peak around 2125 cm^{-1} .^[63]

Alkynes are found in many areas of nature from plant life to bacterial cultures. The alkynes can be isolated from nature, but can also be synthesized organically, they have a broad range of biological properties. These include antibacterial, antimicrobial, antifungal, antitumor, anticancer and anti-HIV.^[64]

2. Results and discussion

Vinyl ethers can be synthesized in an array of different pathways.^[12, 13, 15, 20, 24, 65, 66] Two pathways have been focused on in this investigation, firstly, the textbook method of removing methanol from an acetal using an acid catalyst.^{[15] [16]} Secondly, the elimination of a mesyloxy group.

Carbene chemistry on vinyl ethers make *gem*-dihalocyclopropanes that can be involved in diverse reactions.^[32–35, 59] The focus in this thesis is on transforming them into alkenes.^[59]

2.1 Synthesis of Vinyl Ethers - Method 1

2.1.1 Transforming Acetophenones to Acetals through Acid Catalysis

By treating an acetophenone with methanol, orthoformate and a strong acid such as HCl, a protection of the ketone function as an acetal is obtained.^[9] The protection can be seen in Scheme 12 with three R groups attached. The different R groups attached can be seen in Table 1, and consist solely of methoxy and benzyloxy groups. These functionalities are all electron donating groups (EDGs) and the biggest variation done in this research is the amount of substituents on the aromatic ring.

Two equivalents of methanol are required in the reaction, otherwise an equilibrium with a hemiacetal is formed. The acid, HCl, is the catalyst for this reaction. Trimethyl orthoformate is ideal due to its water-consuming properties. This drives the equilibrium towards the acetal according to Le Chatelier's principle. What is also of note is that the trimethyl orthoformate is also a source for the methoxy group, which additionally pushes the equilibrium towards the product.

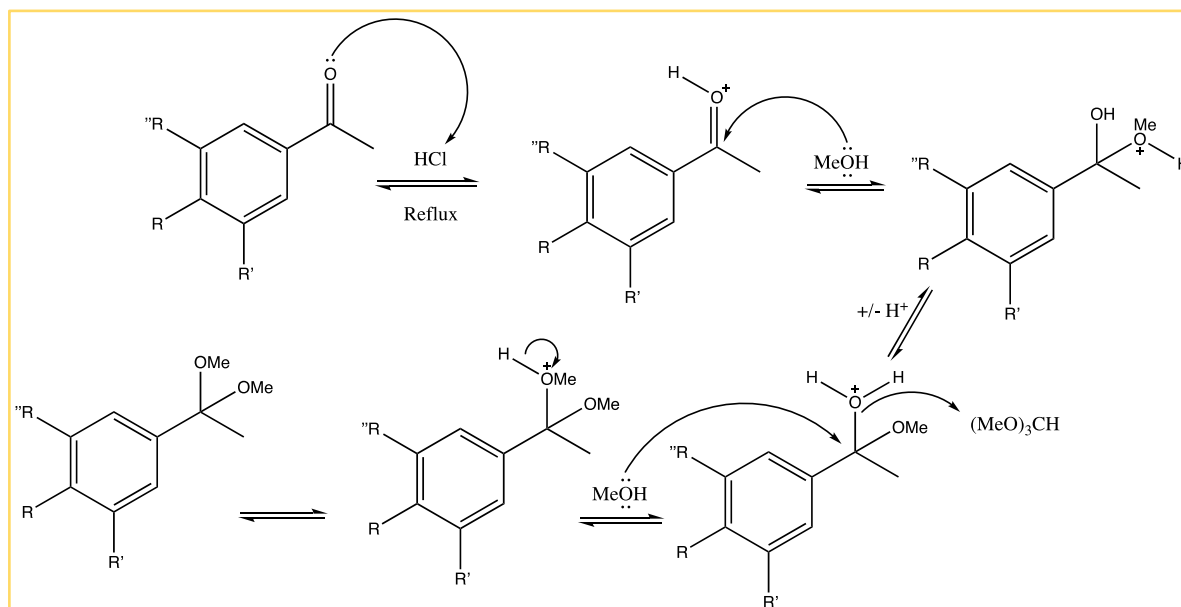

Scheme 12, Protection of Ketone function as acetal.^[67]

Looking at the yields in Table 1, there is an interesting trend. When the aromatic ring only had one substituent the yield was 100%, however when there were two substituents the yield went slightly down. The most extreme change happened from two to three substituents, the efficiency

fell to 63-69% for two of the triple-substituted aromatic rings. The effect of an electron donating group (EDG) is significant in when the group is in the *para* position, however in the *ortho* or *meta* position the EDG functionality is irrelevant. So, the effect of having multiple substituents on the lowering yield is not related to the EDG properties.

Research presented in master theses by D. Maharjan^[22] and Y. Luijckx^[23] showed yields in the 94-95% when working with weak electron withdrawing groups such as chlorine and bromine in the *para* position. These results suggest that the reaction works with excellent yields regardless of the substituent properties on the aromatic ring.

When T. Okano and colleagues did this acetalization in 1995, they tested the acetalization of the naked acetophenone as well as having a methyl and methoxy group in the *para* position.^[14] Unfortunately the theory regarding multiple substituents cannot be compared against his work due to him only having one. On the naked acetophenone Okano had yields in the high nineties, on the methyl and methoxy groups yields of 91 and 95 were obtained respectively. This correlates with the yields obtained in this thesis and displayed in Table 1. High yields are generally obtained for the acetalization reaction.

M. Blümel and colleagues tested a strong electron withdrawing group (EWG), NO₂ on this reaction.^[68] They obtained a yield of 95% this again strengthens, if not proves, the theory that the reaction works excellent regardless of substituent functionality.

No literature was found on the acetalization of three substituents on the aromatic ring, however H. Kunz and colleagues reports a yield of 85% when two methoxy groups are attached to the aromatic ring.^[69] This is still a great yield, but a significant fall has been seen from the single substituted aromatic rings.

Table 1. R groups on aromatic ring of the acetal synthesized and yields.

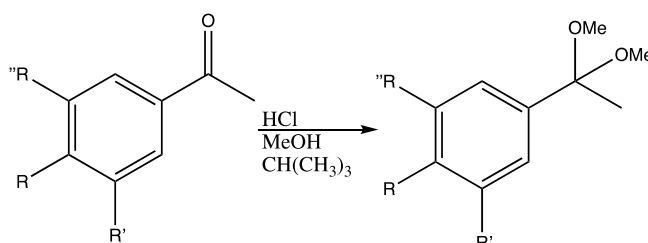

| R | R' | R'' | Yield |
|-----|-----|-----|-------------------|
| MeO | MeO | MeO | 93% ^A |
| BnO | MeO | MeO | 63% ^A |
| BnO | BnO | BnO | 69% ^A |
| MeO | H | H | 100% ^A |
| MeO | MeO | H | 98% ^B |
| BnO | MeO | H | 95% ^A |

A = Isolated yield, B = Crude yield.

2.1.2 Transforming Acetals to Vinyl Ethers through Distillation

By heating the acetal and using a mild acid such as ammonium dihydrogen phosphate ($\text{NH}_4\text{H}_2\text{PO}_4$), methanol can be distilled off giving the corresponding vinyl ether. This step can be seen in Scheme 13.

Ammonium dihydrogen phosphate starts the reaction by protonating one of the methoxy groups. Methanol is an excellent leaving group and an equilibrium is created where the methanol will get pushed out and concomitantly return to the molecule. To prevent the methanol from attacking the delta positive carbon, it is removed from the reaction by distillation.

Since the reaction takes place under dry conditions, there is no suitable nucleophile for $\text{S}_{\text{N}}1$ substitution, and an $\text{E}1$ elimination occurs instead. If any water was present, a hydrolysis reaction would occur.

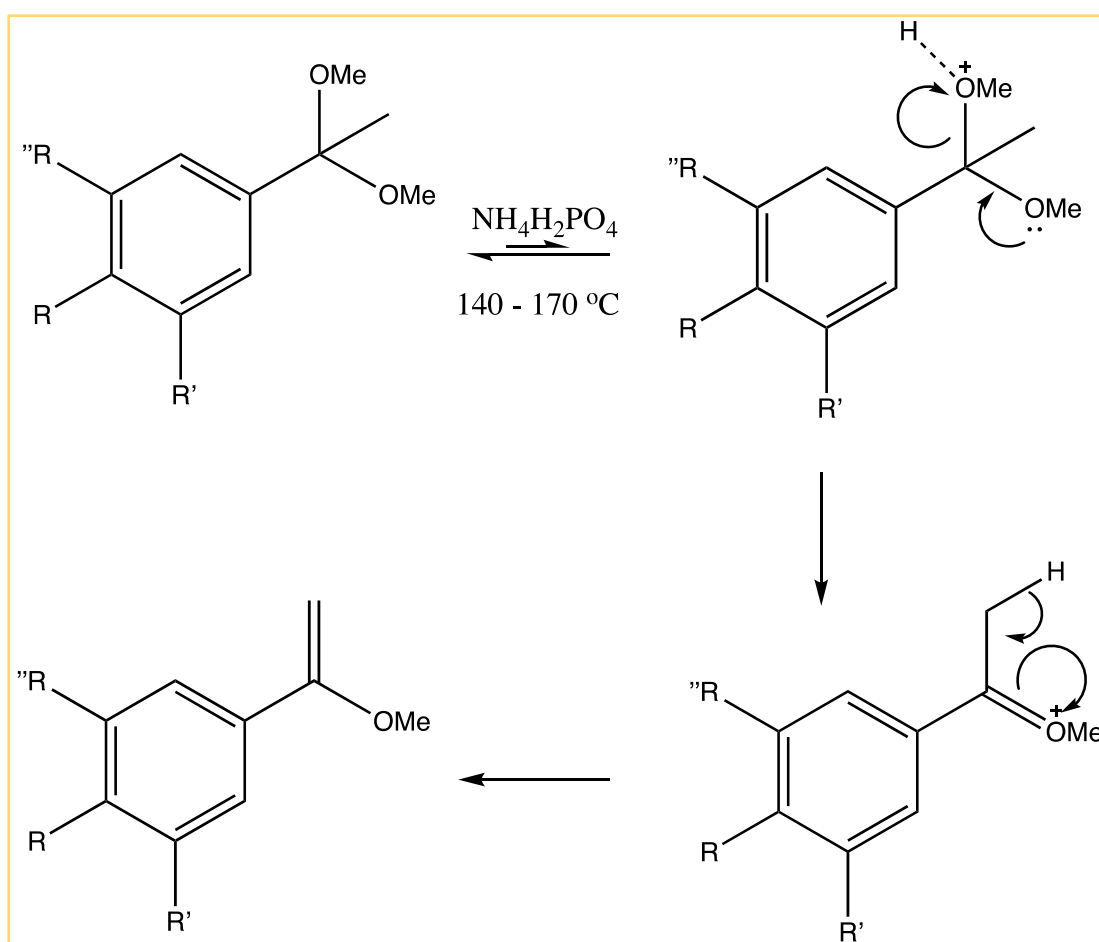

Scheme 13. The synthesis of vinyl ethers from variously substituted aromatic acetals.^[70]

The yields of this reaction can be seen in Table 2. For four of the six reactions the vinyl polymerized and gave no product formation. The other two reactions with successful clean products required multiple attempts before a monomer was acquired. This discovery is not a new phenomenon, several researchers have discovered that vinyl ethers polymerize in a heated environment when an acid catalyst is present.^[16 - 18] As well as this was a prevalent problem in the Bakstad research group,^[22, 23, 71] after a year of difficulties this project was designed to investigate and alleviate from the polymerization problems.

P. G. Gassman had yields in the nineties when synthesizing vinyl ethers.^[15] He worked exclusively with non-aromatic cyclic acetals. One reason as to why these compounds worked better could be due to their low boiling point, allowing for distillation under vacuum. It is of note that when P. G. Gassman tested a substituted cyclic ring, the yield decreased to the low eighties. This could suggest that a larger molecule has more issues with this technique, or that that the technique is regioselective.

Table 2. The different R groups present on the aromatic acetals and their corresponding yields.

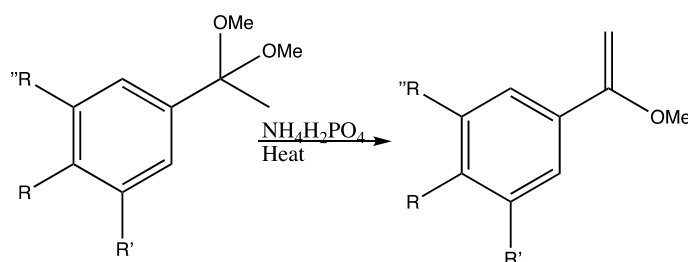

| R | R' | R'' | Isolated Yield |
|-----|-----|-----|----------------------|
| MeO | MeO | MeO | 66% |
| BnO | MeO | MeO | No product formation |
| BnO | BnO | BnO | No product formation |
| MeO | H | H | No product formation |
| MeO | MeO | H | No product formation |
| BnO | MeO | H | 57% |

The reaction conditions for the formation of vinyl from an acetal requires a shift in the equilibrium by removing methanol. The methanol is removed by evaporation during the reaction, which requires a high activation energy. Therefore, a high temperature of approximately 140-170 °C is required in the oil bath. Such a high temperature is harmful to vinyl ethers because of their sensitivity and reactivity. Therefore, heating the compounds naked was extremely difficult. Using solvent although beneficial in some respects, revealed the same issues when the solvent was to be removed under reduced pressure. Other attempts to avoid polymerization was done by changing the acid used to an even milder one, such as silica gel. No difference in polymerization was noted. The vinyl ether polymerizes very easily and avoiding both high temperatures and acids seems essential for future vinyl ether prospects.

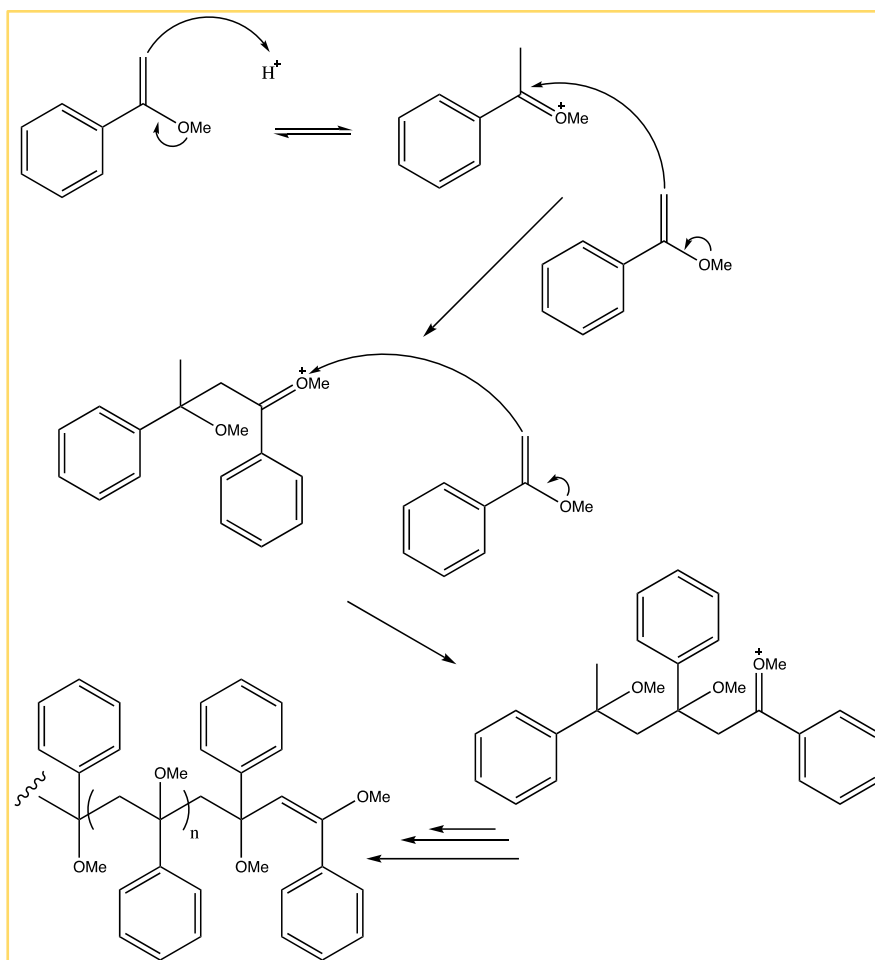

Scheme 14. Proposed mechanism for polymerization of vinyl ether.

Scheme **14** elucidates a possible reaction mechanism for the polymerization of a styrene vinyl ether. There is a consensus that vinyl ethers polymerize in an acidic environment, however no mechanism for this process has been acknowledged.

Vinyl sp^2 cations are unstable and an S_N1 type dissociation of methanol is very unlikely. Instead, vinyl ethers, also called enol ethers, are very similar in reactivity to enols. They are nucleophilic on the alpha carbon, which can thus be protonated. This is almost like a tautomerization of an enol back to a ketone. These features of the vinyl ether could initiate a cascade of reactions. The protons are available to the nucleophilic carbon which again is open to the attack of another vinyl ether. In summary, this reaction would most likely continue until no more vinyl ether was available.

2.1.3 Total Yield for Method 1

From the six acetophenones, only two survived the mild acid and distillation of methanol. The total yield from the two-step method can be seen in Table 3.

Table 3. Total yield for method 1 involving an acetal intermediate.

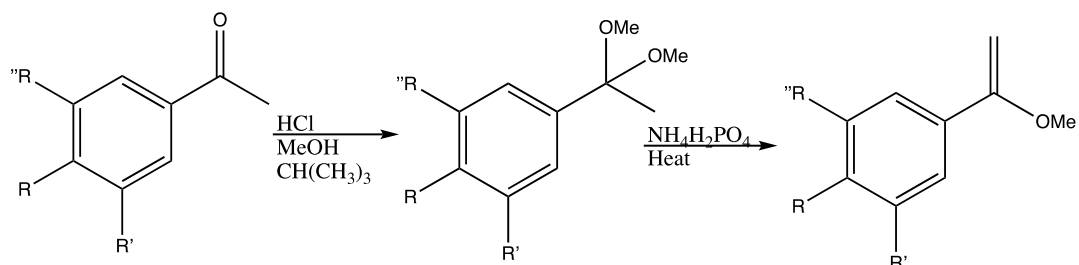

| R | R' | R'' | Yield |
|-----|-----|-----|----------------------|
| MeO | MeO | MeO | 61% |
| BnO | MeO | MeO | No product formation |
| BnO | BnO | BnO | No product formation |
| MeO | H | H | No product formation |
| MeO | MeO | H | No product formation |
| BnO | MeO | H | 54% |

A solvent was considered in the second step as this would most likely reduce the polymerization risk. The idea of the solvent is slightly complicated because it would need to have a higher boiling point than methanol, but when a vacuum is added it would need to distill over at a relatively low temperature to not put the vinyl ether at risk. Such a solvent was not found by the researcher as well as it took several attempts at step two before the two synthesized vinyl ethers were finally made. A member of the Bakstad research group, Sagstad found that when using toluene as a solvent an azeotrope was formed between toluene and methanol, making the reaction generally more successful.^[71] Unfortunately this was not tested in this thesis.

Consequently, even though the two successful vinyl ether reactions had relatively good yields, the overall method seems to need some advances before it could work without the danger of polymerization.

2.2 Synthesis of Vinyl Ethers - Method 2

2.2.1 Aldehyde Epoxidation with the Corey-Chaykovsky Reaction

Transforming an aldehyde to an epoxide can be done through the Corey-Chaykovsky reaction.^[25] This involves trimethyl sulfonium iodide ($\text{Me}_3\text{S}^+\text{I}^-$), a strong base such as sodium hydride (NaH) and tetrahydrofuran (THF) as solvent. Scheme 15 shows the mechanism of the first step in the second method.^[25]

The sodium hydride removes a proton from trimethyl sulfonium iodide, this negatively charged carbon then attacks the aldehyde and a C-C bond formation takes place. Since this reaction takes place in a basic environment this results in an alkoxide. The alkoxide, attacks the newly bonded carbon. This attack forces the sulfonium group to leave the molecule generating an epoxide.

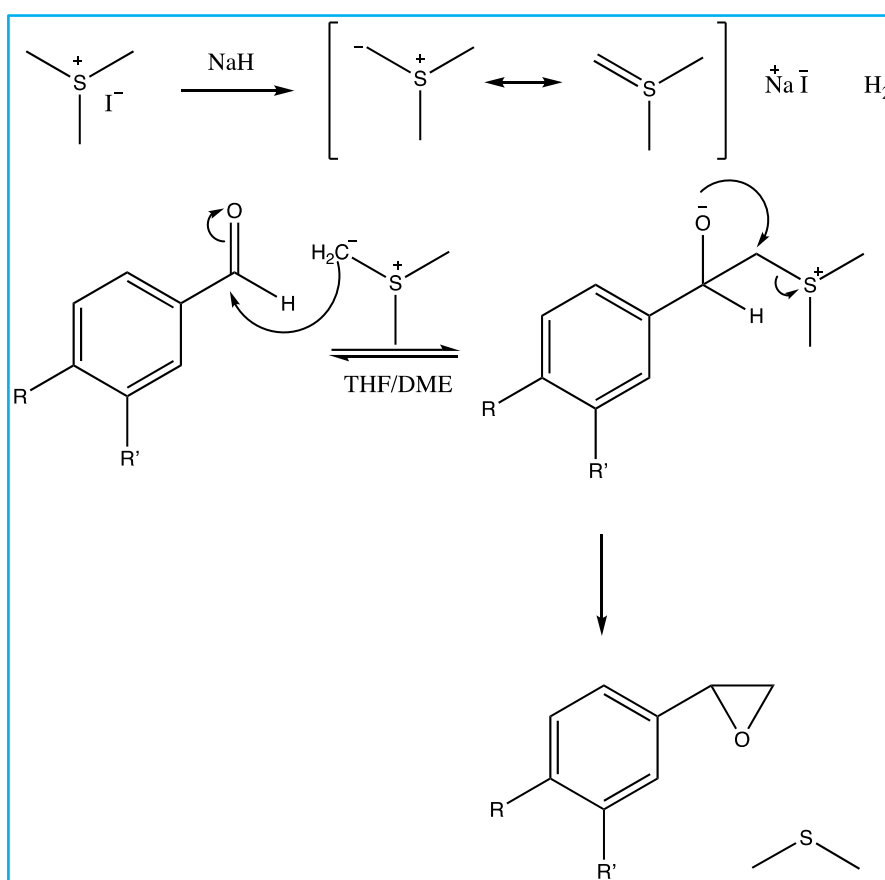

Scheme 15. Transforming an aldehyde into an epoxide through the Corey-Chaykovsky reaction.^[25]

Multiple parallels were done with 1,2-dimethoxy ethane (DME) as a solvent as an alternate to THF. The results with DME gave slightly better yields than those with THF. Therefore, DME was used as solvent in the general procedure instead of Corey Chaykovsky's THF. A theory regarding the benefits of using this solvent in this theses could be the slightly higher polarity of DME in comparison to THF.

Additionally, sodium bis(trimethylsilyl) amide (NaHMDS) and potassium bis(trimethylsilyl) amide (KHMDS) were tested as alternative bases. The KHMDS worked in higher yield than the NaHMDS, but overall they both came secondary to sodium hydride.

Table 4. The different R groups present on the aromatic epoxides and their corresponding yields.

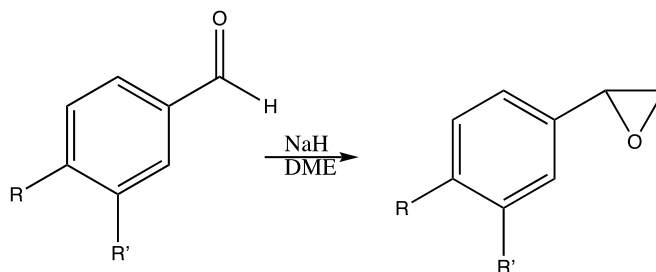

| R | R' | Isolated Yield |
|-----|-----|----------------|
| H | H | 65% |
| BnO | H | 99% |
| H | BnO | 75% |
| BnO | BnO | 65% |
| BnO | MeO | 75% |

The naked aromatic ring had the lowest yield as seen in Table 4. When one EDG was added in the *para* position the yield increased dramatically to 99%. It is very interesting that when the same EDG was in the *meta* position the yield decreased to 75%. Of further note, when two EDGs were added in the *para* and *meta* position the yield did not go further down. This reaction presumably favours an electron rich environment around the aldehyde functionality.

When E. J. Corey and M. Chaykovsky first developed and published this reaction in 1965, they tested benzophenone, cycloheptanone and benzaldehyde.^[25] The only directly comparable to this research is the benzaldehyde. E. J. Corey and M. Chaykovsky had a yield of 57% on the benzaldehyde epoxidation. Considering they got a yield of 90% with a benzophenone, this further strengthens the hypothesis regarding an electron rich environment around the ketone or aldehyde functionality.

2.2.2 Styrene Epoxidation using the Prilezhaev Conditions

Another way of synthesizing epoxides is the oxidative transformation of a styrene to an epoxide by the addition of *meta*-chloroperoxy benzoic acid (*m*-CPBA) in a solvent such as dichloromethane (DCM). This oxidation mechanism can be seen in Scheme 16 below.

This reaction is named after N. Prilezhaev who first described the reaction already in 1909.^[26] The *m*-CPBA reacts with the styrene in such a way as a butterfly transition state is generated. This state is characterized by the addition of an oxygen and a proton shift occurring simultaneously. From this single step the desired epoxide is generated, along with *meta*-chlorobenzoic acid. This acid is removed from the system during workup using pentane. The acid is not soluble in pentane, but the desired epoxide is soluble. This allows for pentane to dissolve the product whereby a filtration removes the acid from the mixture.

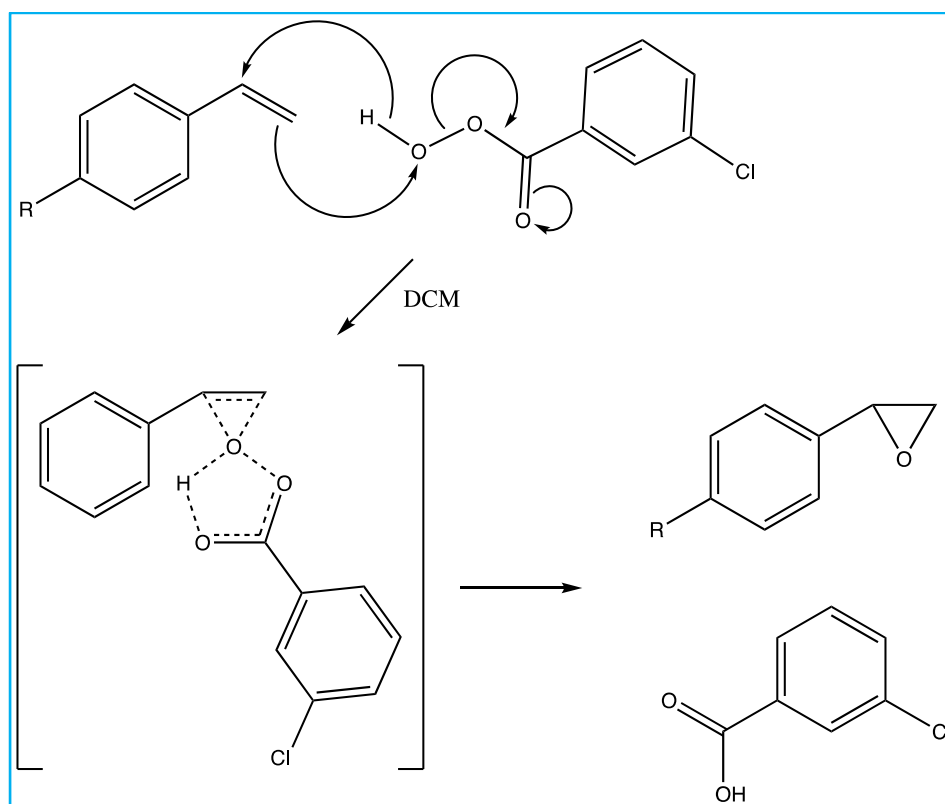

Scheme 16. Oxidation of a styrene into an epoxide with *m*-CPBA.^[72]

Only two of the reactions were successfully completed with the oxidation reaction, the third gave no product formation, only starting material was noted (Table 5).

Both the methyl and tertiary butyl group are weak EDGs, the *tert*-butyl group is more so due to the inductive effects of the three methyl groups attached. The stronger EDG group tested using this method would not undergo the epoxidation under these conditions, even with an excess of *m*-CPBA. This is an extreme oddity and research by Paul and colleagues found that as increasing EDG properties were in the *para* position, the yield increased from 66% to 98% from bromine to methoxy.^[73] This makes sense as the double bond needs available electrons to start this reaction. The reason for the one failed reaction in this thesis remains unknown and is considered an outlier rather than a real discovery.

Nasseri has recently explored this reaction and found great yields of up to 97% on styrene.^[74] Since the phenyl oxirane (**26**) is commercially available, this epoxide was not synthesized in this manner. Nasseri however, got excellent yields on all the molecules he treated with *m*-CPBA. Nasseri used a catalyst for the reaction, oxidized iron and silicon nanoparticles. Obviously, this is a major modification to the original Prilezhaev reaction conditions, which probably benefitted him and his yields. This modification is not significantly expensive and could benefit the yields greatly. It would be interesting to note whether the *tert*-butyloxy would react with the *m*-CPBA if this catalyst was in the mixture.

Table 5. The different R groups present on the aromatic epoxides and their corresponding yields.

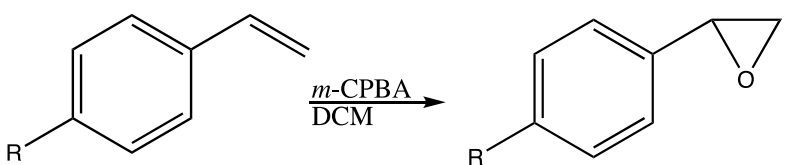

| R | Isolated Yield |
|-----------------------------|----------------------|
| Methyl (Me) | 64% |
| <i>Tert</i> -butyl (Bu) | 82% |
| <i>Tert</i> -butyloxy (BuO) | No product formation |

The epoxidation reaction left no unreacted starting material in the two successful reactions, but it did have some side products before being isolated. Due to chemical shifts in the δ 9.00-10.00 range on the ¹H NMR spectra an aldehyde was most likely present. The most likely scenario would be that the epoxide ring opened and oxidized due to the *meta*-chlorobenzoic acid. This suggested aldehyde is depicted in Figure 8. Table 6 shows the literature on this compound and the strikingly similar ¹H NMR results is a strong indication that such a side product was indeed obtained.^[75]

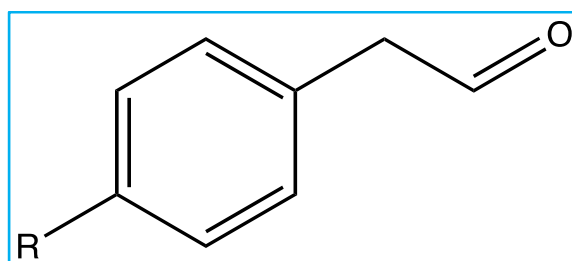
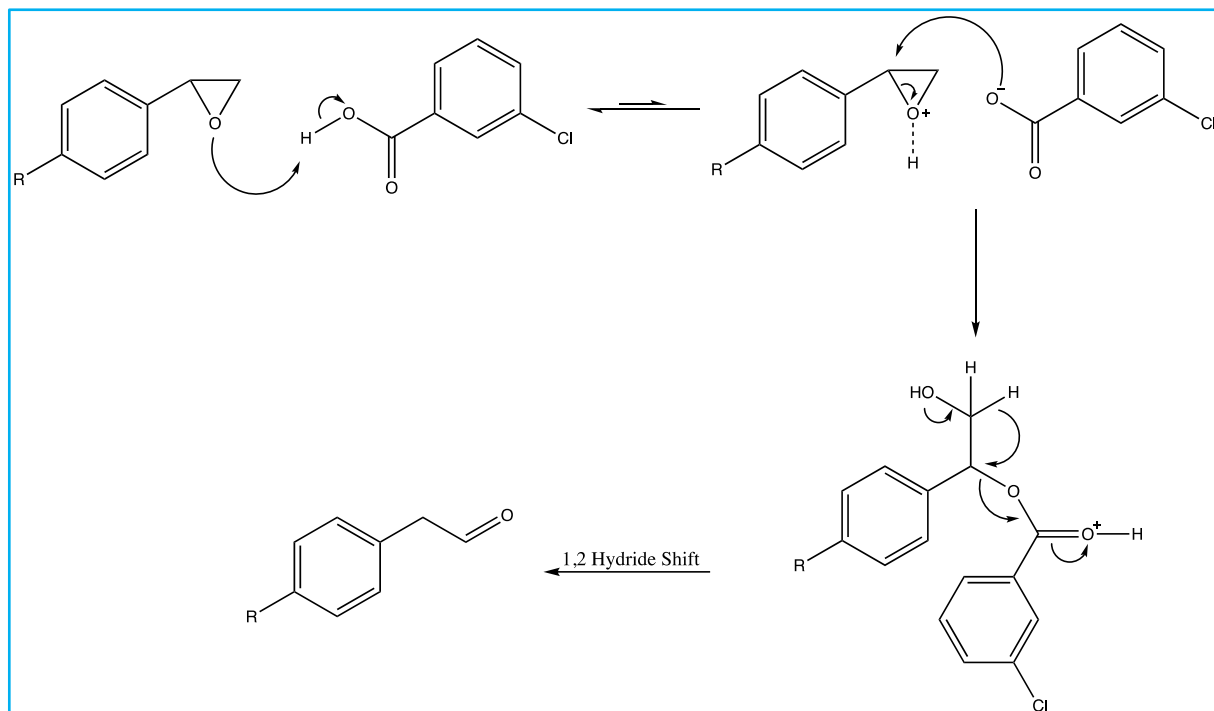

Figure 8. Minor product in epoxidation reaction. With R group equal to a methyl group or a *tert*-butyl group.

Table 6. Literature and obtained ¹H NMR on possible side product.^[75]

| Literature ¹ H NMR Methyl R group | ¹ H NMR Methyl R group | ¹ H NMR <i>Tert</i> -butyl group |
|---|--------------------------------------|--|
| 9.73 (t, <i>J</i> = 2.1 Hz) | 9.72 (t, <i>J</i> = 2.4 Hz) | 9.74 (t, <i>J</i> = 2.4 Hz) |
| 3.65 (d, <i>J</i> = 2.1 Hz) | 3.64 (d, <i>J</i> = 2.4 Hz) | 3.65 (d, <i>J</i> = 2.4 Hz) |

A proposed reaction mechanism for the ring opening is given in Scheme 17. Here, a pinacol-like rearrangement is suggested to synthesize the aldehyde side product.^[70]



Scheme 17. Proposed mechanism for the undesired aldehyde minor product.

2.2.3 Transforming Epoxides to Methoxy Alcohols by Lewis Acid

Regioselective ring opening an epoxide is simple when a Lewis acid is used. In this case boron trifluoride diethyl etherate ($\text{BF}_3 \cdot \text{OEt}_2$) was the Lewis acid, and methanol was both reagent and solvent. Scheme 18 displays the mechanism of the reaction.^[76]

Methanol attacks the most electron deficient carbon and the loss of hydrogen fluoride gives the desired molecule. No signal was seen regarding the formation of the methoxy group on the secondary carbon. Ring opening an epoxide with acid is generally considered more complicated than with base. This is due to some loss of regioselectivity, however, due to the compounds in this thesis being aromatic we have a benzylic hydrogen. This hydrogen has a considerably lower pK_a directing the attack towards it.

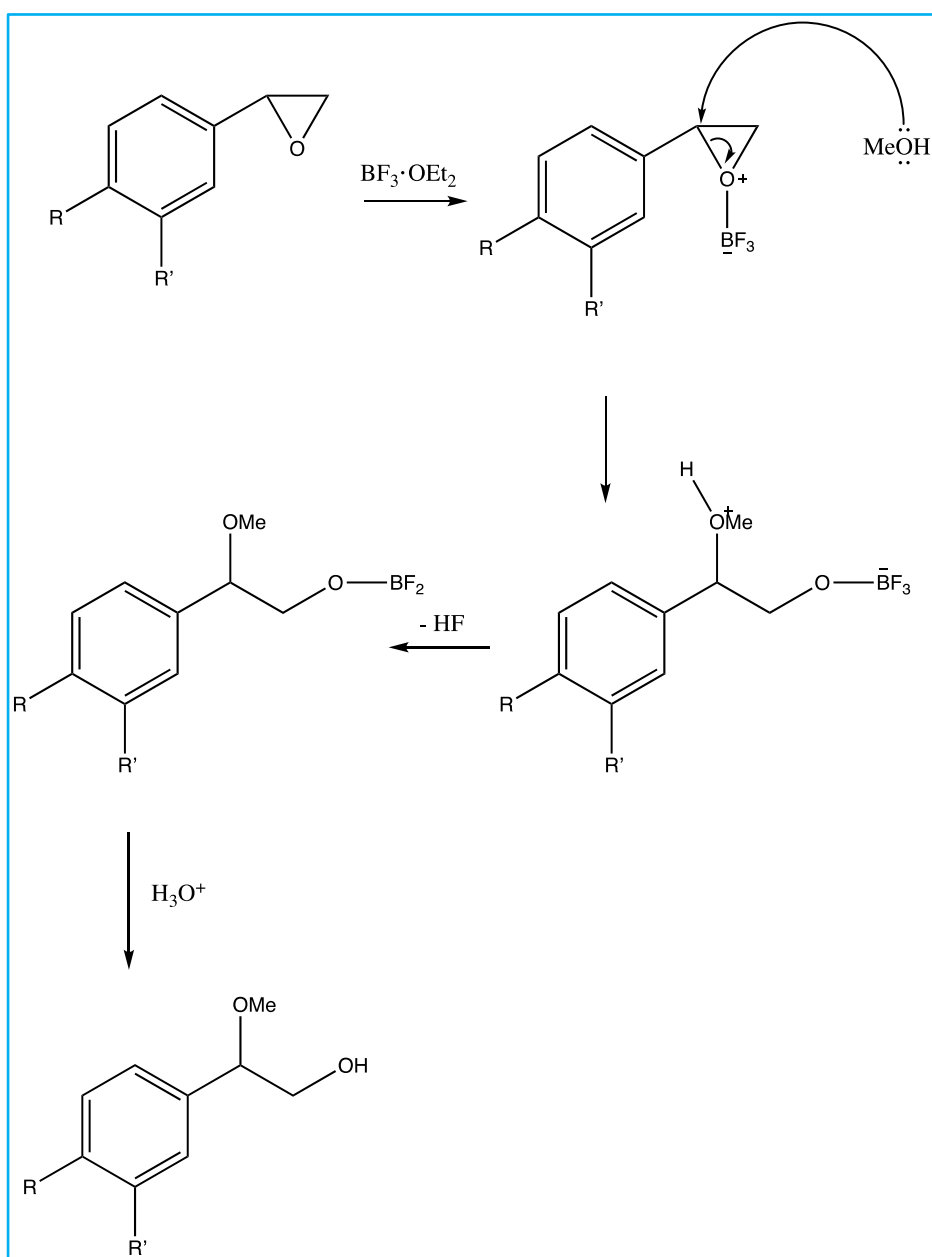

Scheme 18. Regioselective ring opening of epoxide with lewis acid to synthesize a methoxy alcohol.^[76]

The naked aromatic ring had a high yield in the regioselective ring opening reaction as can be seen from Table 6. The general rule seems to be that when substituents are added the yield goes down. The fact that this happened regardless of EDG properties substituted is noteworthy. The worst yield was seen from the *tert*-butyl group, possibly indicating that the reaction slightly favours an electron deficient environment.

X. L. Liu and colleagues explored very similar compounds to the ones described Table 7.^[77] They tested the naked phenyl oxirane as well as substituents such as methyl, methoxy and ethoxy groups on the aromatic ring. X. L. Liu unfortunately does not report any yields but reports a high degree of regioselectivity (98%). This supports the findings in this thesis considering no peaks of the other product was seen on either ¹H NMR or ¹³C NMR which effectively excludes the possibility of there being much of the other possible ring opened product.

Table 7. The different R groups present on the aromatic methoxy alcohol and their corresponding yields.

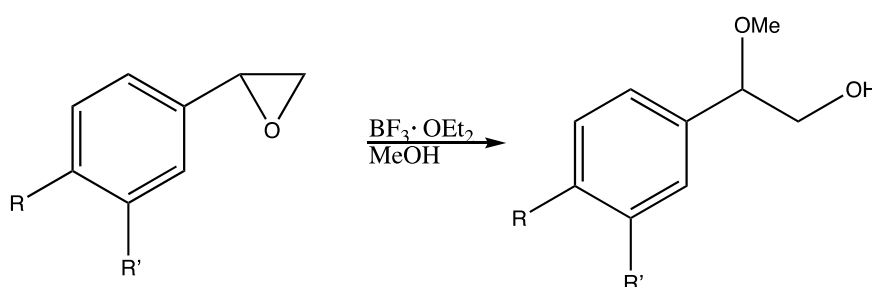

| R | R' | Isolated Yield |
|-----|-----|----------------|
| H | H | 90% |
| Me | H | 84% |
| Bu | H | 57% |
| BnO | H | 69% |
| H | BnO | 68% |
| BnO | BnO | 99% |
| BnO | MeO | 74% |

2.2.4 Substitution of a Methoxy Alcohol into a Mesylate

Alcohols are readily substituted by a mesylate using a dry environment, mesylchloride (MsCl), a base such as triethylamine and DCM as solvent. Scheme 19 shows the mechanism of the functional group interconversion that occurs with MsCl and alcohol.^[67]

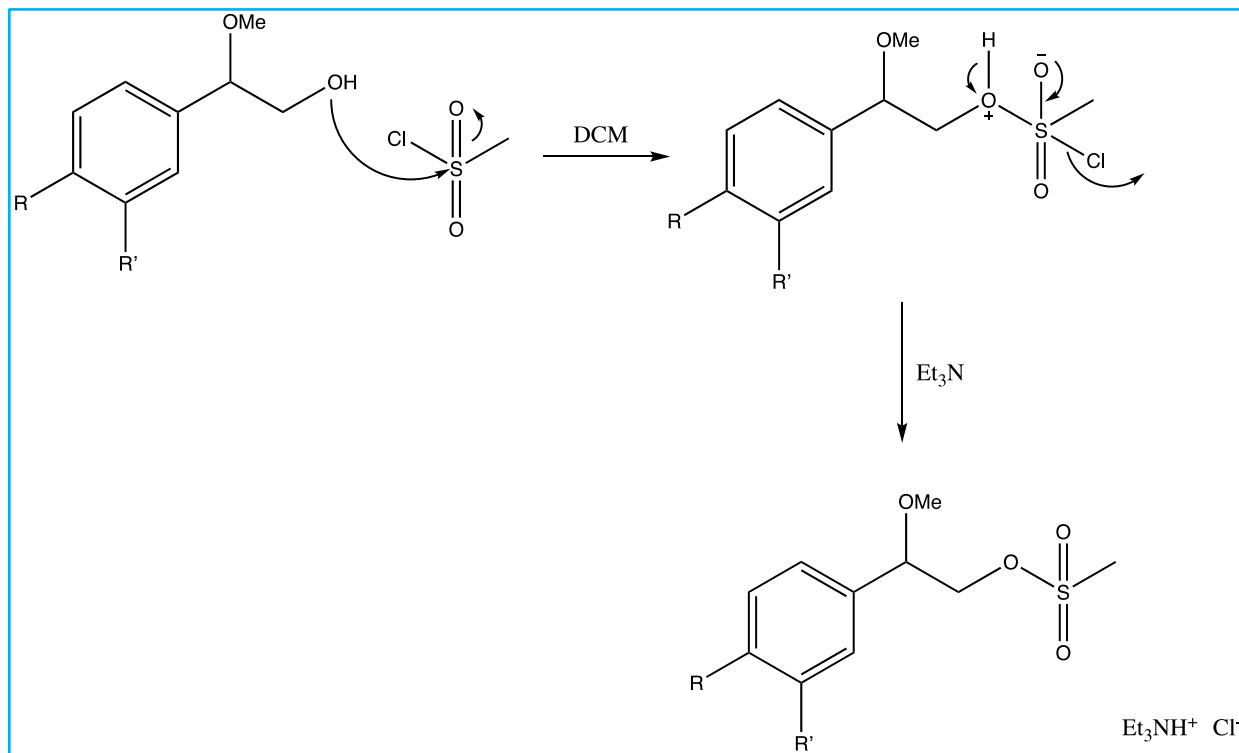

Scheme 19. Changing alcohol functionality to a mesyloxy leaving group.^[67]

The mesylating reaction benefits from having weaker EDGs on the aromatic ring. From Table 8 one can see the yield slightly increasing from a naked aromatic ring, to having a methyl group in the *para* position and having the best yield with the *tert*-butyl group in the *para* position. What further strengthens this suggestion is that when the strong EDG, benzyloxy, is in the *meta* position it has a significantly higher yield than when the same group is in the *para* position. In general, the reaction worked with excellent yields for all the compounds as was expected.

This exact method of mesylating such a methoxy alcohol has been seen with excellent yields by J. B. Jones and colleagues.^[78] They achieved a yield of 99% on the non-substituted aromatic ring. This is slightly higher than the yields in this report.

Table 8. The different R groups present on the aromatic mesylates and their corresponding yields.

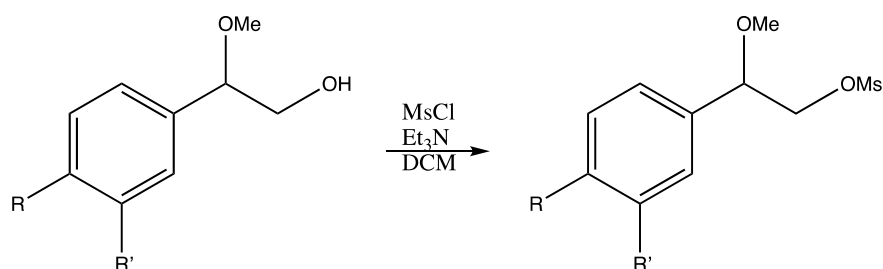

| R | R' | Yield |
|-----|-----|------------------|
| H | H | 92% ^B |
| Me | H | 95% ^A |
| Bu | H | 97% ^A |
| BnO | H | 85% ^A |
| H | BnO | 94% ^A |
| BnO | BnO | 84% ^A |
| BnO | MeO | 65% ^A |

A = Isolated Yield, B = Crude Yield.

2.2.5 Elimination of Mesylates to Synthesize Vinyl Ethers

Elimination reactions of mesylates are well known as mesyloxy is an excellent leaving group.^[29] Doing so to make a vinyl ether can be done by the aid of a strong base such as potassium *tert*-butoxide (*t*-BuOK) in DME as a solvent. The mechanism of the final step in method two is proposed in Scheme 20, the mesyloxy group is eliminated to synthesize the desired vinyl ether.

The elimination of the mesyloxy group most likely follows an E2 reaction pathway. The *t*-BuOK extracts the benzylic proton which creates the vinyl ether and pushes the mesyloxy leaving group out. The mesyloxy forms a salt that is easily flushed under work up.

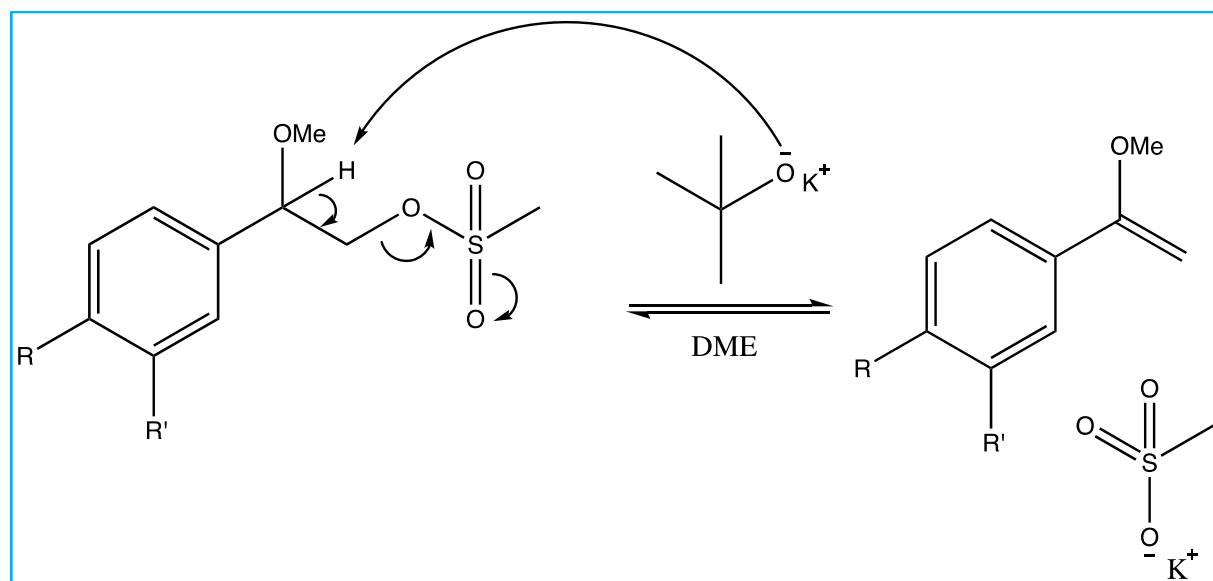

Scheme 20. The proposed synthesis of vinyl ethers from variously substituted aromatic mesylates.

The yields obtained from this vinyl ether synthesis can be seen from Table 9. The elimination reaction worked with excellent yields for all the vinyl ethers synthesized.

S. Winstein^[20] and L. David^[24] explored the leaving groups I and Br respectively on the methoxy vinyl benzene (**53**). S. Winstein achieved a 95% yield with iodine as a leaving group, which is identical to L. David whom also obtained 95% with bromine. On **53** a yield of 84% was obtained in this report with mesyloxy as the leaving group. This is a lower yield than what S. Winstein and L. David achieved with the halogens, however it could be argued that the cheap mesylchloride in comparison to the iodine salt (KI/KIO₃) and bromolithium makes up for this slight loss in yield. The other vinyl ethers synthesized using this method had all great yields and the method is a cost-efficient route to the desired molecules.

Table 9. The different R groups present on the vinyl ethers and their corresponding yields.

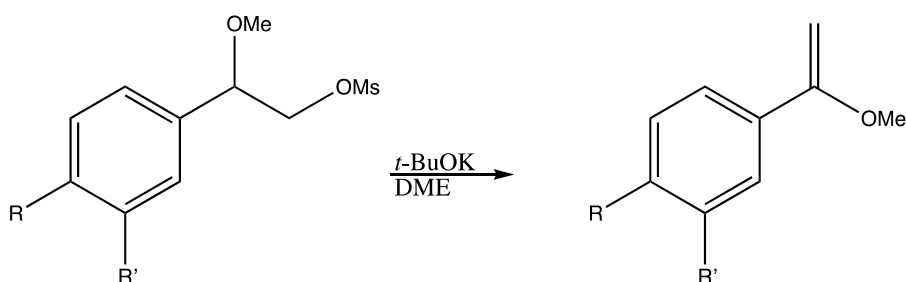

| R | R' | Isolated Yield |
|-----|-----|----------------|
| H | H | 84% |
| Me | H | 94% |
| Bu | H | 82% |
| BnO | H | 90% |
| H | BnO | 87% |
| BnO | BnO | 78% |
| BnO | MeO | 97% |

By adding some additional steps of going through the epoxide, regioselective opening, mesylating and finally eliminating the mesyloxy the Bakstad research group has successfully managed, to the authors best knowledge, to create a new procedure for obtaining vinyl ethers. This method made it possible to obtain high yields of the vinyl ethers in a cheap manner.

2.2.6 Total Yield for Method 2

The overall synthesis for producing vinyl ethers had four steps, the yield from the synthesis as a whole is displayed in Table 10. The yields obtained are in the range of 35-52% as a whole. From this it can be concluded that the secondary method is a suitable way of synthesizing vinyl ethers, with the acknowledgement of some loss in yield that is inevitable with a multistep procedure. It could be proposed that this technique leads to the wanted product in a more controlled manner than through the acetal intermediate, and that therefore this loss is negligible.

Table 10. The total yield for various vinyl ethers with R groups and corresponding yields presented.

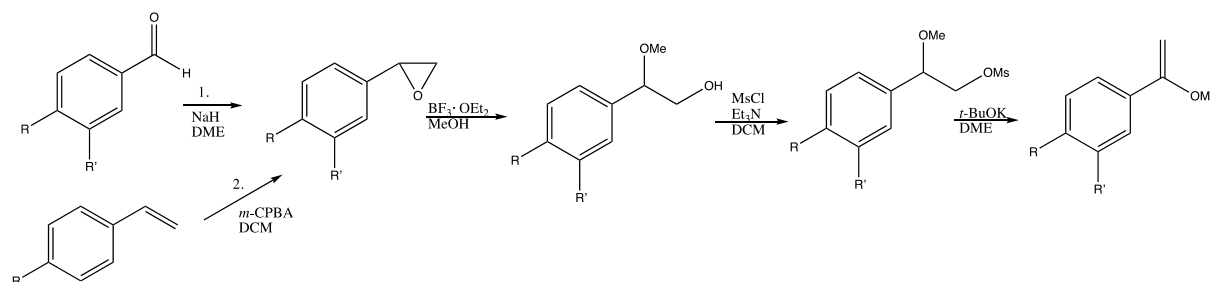

| R | R' | Yield |
|-----|-----|------------------|
| H | H | 45% ¹ |
| Me | H | 48% ² |
| Bu | H | 37% ² |
| BnO | H | 52% ¹ |
| H | BnO | 48% ¹ |
| BnO | BnO | 42% ¹ |
| BnO | MeO | 35% ¹ |

1 = Pathway 1, from aldehyde. 2 = Pathway 2, from styrene

2.3 Synthesis of Acetylenic Acetal from Methyl Glyoxal Acetal

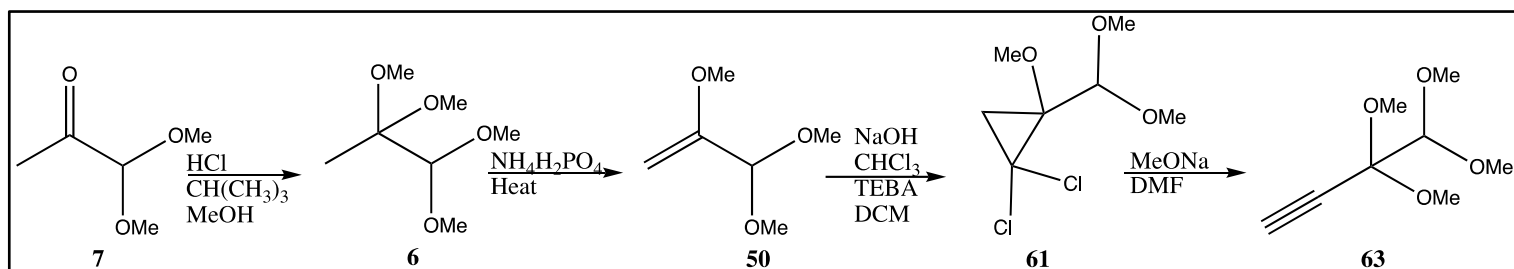

Scheme 21. The four step synthesis of Acetylenic Acetal.

The synthesis of the diacetal alkyne has been done in four steps (Scheme 21). The first two steps are of familiar nature from previous work in this thesis, it regards the protecting of the ketone with acetal then pushing the equilibrium towards the vinyl ether using a mild acid. These steps worked with high yields, 82 and 94% respectively. The following step involves carbene chemistry that makes a *gem*-dihalocyclopropane which was regioselectively ring opened to give the diacetal alkyne. These two reactions worked with medium yield, 62% and 68% respectively. This gives the total synthesis of the alkyne a yield of 32%.

From the unpublished work of the Bakstad research group yields of 93%, 94%, 86% and 95% were obtained on those four steps respectively.^[79] This gives an overall yield of 71%, which is drastically higher and more advantageous results than the one in this report. The method for synthesizing the acetylene acetal is promising and should be investigated further to note the efficiency on a wider array of molecules.

The Makosza reaction, step 3 in Scheme 21, occurs over two phases and the reaction with TEBA happens in the interphase between the water phase and the organic DCM phase. The reaction was accomplished with a simple ethyl vinyl ether (60) and 2,3,3-trimethoxyprop-1-ene (50). The cyclopropane is highly reactive and cannot always be isolated before it ring opens, but in the cases presented in this theses it was sufficiently stable for characterization.

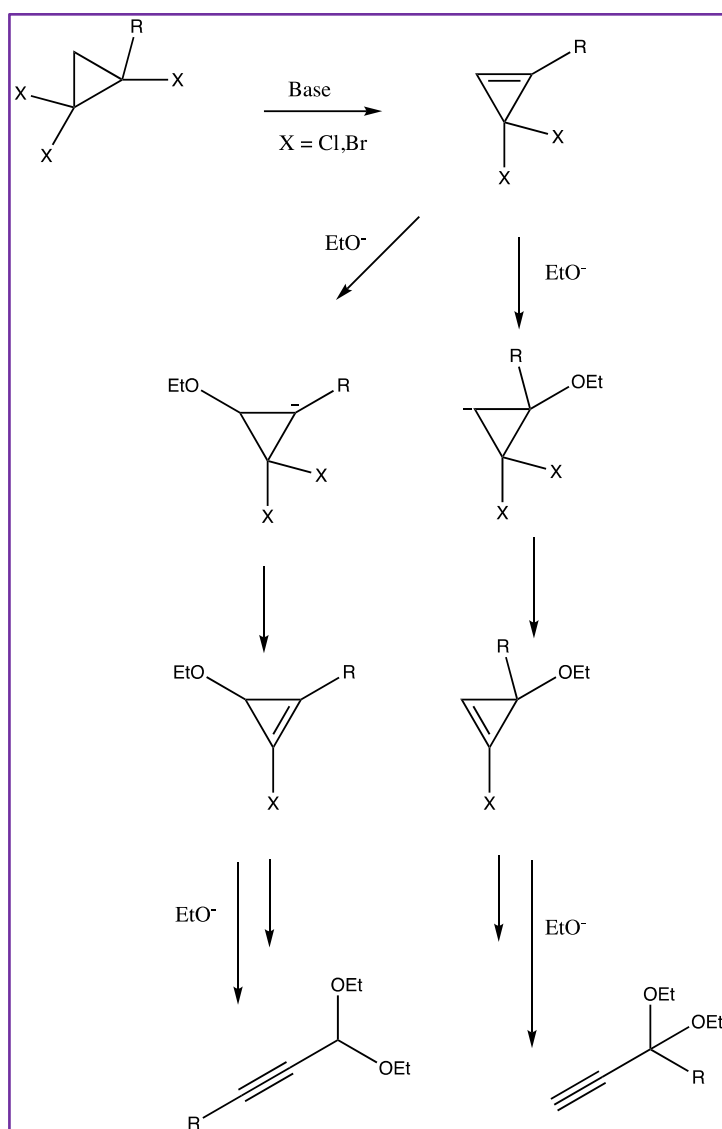

Scheme 22. The reaction pathway of the conversion of a dihalo cyclopropane into an acetylene.^[59]

Acetylene acetals can also be synthesized with trihalocyclopropanes. The reaction pathway proposed by Sydnés and Bakstad in 1996 for these acetylenes is illustrated in Scheme 22.^[59, 80] In this thesis the focus is on *gem*-dihalo cyclopropanes.^[81]

Transforming a *gem*-dihalo cyclopropane into an acetylene acetal can be completed using a sodium ethoxide or methoxide base in DMF as the solvent. The Bakstad research group found that DMF was the ideal solvent in this acetylene reaction.^[22, 79] No reaction occurred in acetonitrile and THF as well as MeOH and DME gave a chloroalkene acetal instead of the acetylene. DMF is a polar aprotic solvent and for unknown reasons this solvent is favoured in this reaction.

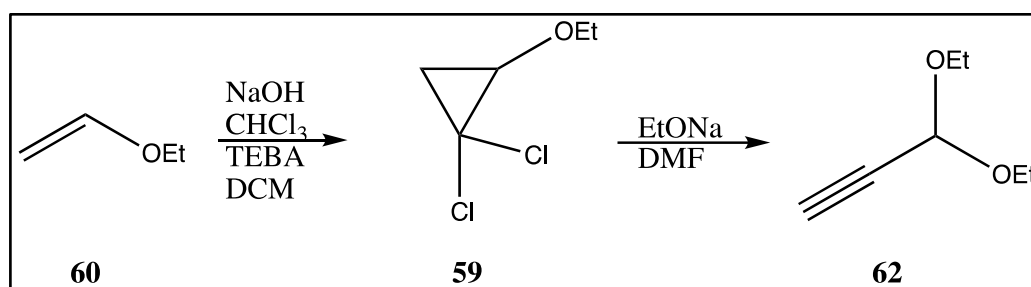

Scheme 23. Synthesis of Acetylenic acetal from ethoxy vinyl.

The last two steps were initially done with a simple ethyl vinyl ether to explore the success of the method on a simple molecule (Scheme 23). The synthesis of the cyclopropane had a higher yield of 87%, but the alkyne gave a very similar yield of 69%. This was promising results and therefore the reaction was tested on compound 50.

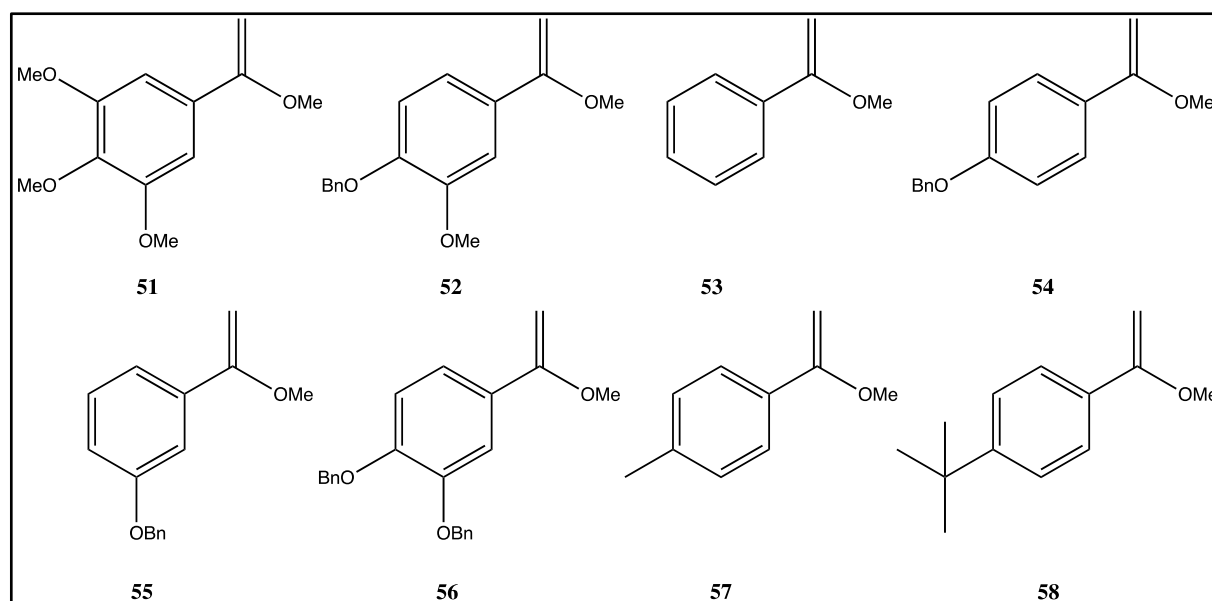
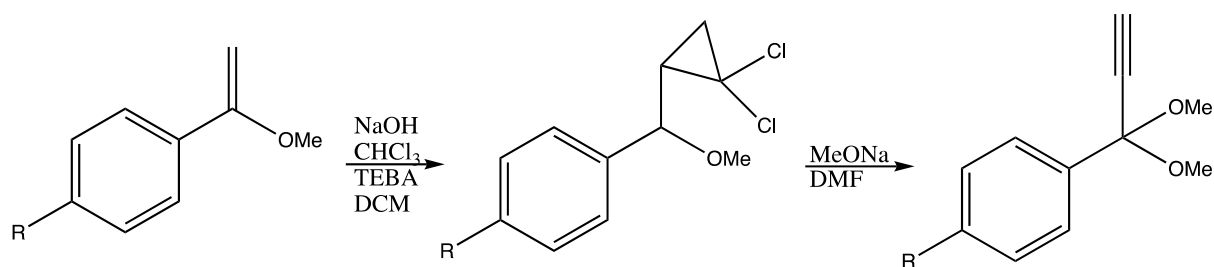

Figure 9. Aromatic vinyl ethers synthesized.

Due to time constraint the aromatic vinyl ethers; 51, 52, 53, 54, 55, 56, 57 and 58 were not subject to the carbene chemistry and subsequently transformed into the corresponding acetylenes (Figure 9). However, the Bakstad research group has previously done some work on aromatic vinyl ethers and their reactions with carbenes to synthesize acetylenic acetals. The results of D. Maharjan is noted in Table 11.^[22] These yields are excellent for the cyclopropane product and great for the acetylenic acetal. Her research captures how well vinyl ethers react with carbenes to synthesize acetylenic acetals.

Table 11. Dilita Maharjan results using carbene chemistry on aromatic vinyl ethers.^[22]

| R | Yield <i>Gem</i> -dihalocyclopropane | Yield Acetylenic Acetal |
|---------------------|---|----------------------------|
| H | 98% | 65% |
| Fl | 92% | 78% |
| Br | 90% | 70% |
| Me | 80% | 61% |
| <i>t</i>-BuO | 82% | 72% |
| <i>t</i>-Bu | 78% | 59% |

2.4 Concluding Remarks and Future Work

Protecting ketone functions as acetals worked with high yields. Seven ketones were protected in yields ranging from 63 - 100%. There is a large range in the results, which seemed to depend on the number of substituents on the aromatic ring. However, the reaction generally worked with excellent efficiency.

Two different methods were used to obtain vinyl ethers. The first method involved an acid catalysed thermolysis of the corresponding acetal. The second method involves the vicinal functionalization of an olefinic compound and the elimination of a mesyloxy group by a non-nucleophilic base.

Regarding the first method, two molecules were synthesized in high yields. The other four vinyl ethers polymerized and thereby destroyed any options of furthering work on them. To optimize this method increased knowledge needs to be obtained on the exact structure of the polymers synthesized. X-Ray crystallography is one possibility that could be used to determine the structure. As no solvents can be used on polymers; ¹³C NMR, ¹H NMR, IR and MS is unavailable for analysis.

All the steps in the second method had good to great yields and no polymerization was seen. Therefore, the second method with the elimination of mesyloxy was the preferred pathway of synthesizing vinyl ethers. There was one outlier in the results regarding the oxidation of *tert*-butyloxystyrene. It did not react with the *m*-CPBA to form the desired epoxide. In general the epoxidation reactions using this technique had slight difficulties. It could therefore be a potential benefit to invest in oxidized iron and silicon nanoparticles that M. Nasserri used as a catalyst for the reaction.^[74]

Elimination with iodine has been seen in literature and in the Bakstad research group with promising yields. Elimination of bromine has also shown great promise. As far as the researcher is aware there are multiple other leaving groups that have not been tested, such as chlorine,

tosylate and triflate. Additionally, removing water directly from the methoxy alcohol using Dean Stark equipment could also be a potential synthesis for the vinyl ether in one less step.

Although water is an excellent leaving group and the Dean-Stark equipment is often used for these types of eliminations, there is a concern. Previously, with the elimination of methanol from an acetal to form a vinyl ether, polymerization caused major difficulties with the synthesis. In the Dean Stark equipment, we again face the struggle of having an acidic environment and increased temperature. Under these conditions there is a real danger of polymerization, it is however worth noting that the temperature does not need to exceed 60 °C in such a set up, so it is possible that the vinyl ethers would survive the process and therefore worth trying. However, by having a mesyloxy leaving group this concern is directly diverted and the final vinyl ether synthesis happens under basic conditions at room temperature.

Two different *para*-substituted 2-alkoxy-1,1-dihalocyclopropanes were synthesized from a corresponding vinyl ether under standard Makosza methods. Transforming the *gem*-dihalocyclopropanes into alkynes proved unproblematic and promising.

Other future work involves preparing cyclopropanes and acetylene acetals from synthesized vinyl ethers. Many of the corresponding cyclopropanes and acetylenic acetals are undescribed as well as these compounds are very interesting in organic synthesis.

It is also of great interest to test non-aromatic aldehydes and alkenes with the new method of synthesising vinyl ethers. The two-step method involving acetals has been described with non-aromatic compounds. The four-step method, on the other hand, has only been explored with aromatic compounds. Therefore, it would be interesting to note whether it can succeed without the benzylic hydrogen involved.

3. Experimental

3.1 General

3.1.1 Solvents and reagents

Commercially available chemicals were purchased from Fluka, Sigma-Aldrich, Acros, Merck, Lancaster and Chiron. Standard purification was applied if necessary. Dry dichloromethane, ethyl acetate and acetone were purchased from Fluka and Sigma-Aldrich.

3.1.2 Spectroscopic and Physical analysis

Nuclear magnetic resonance 400 MHz ^1H NMR spectra and 100 MHz ^{13}C NMR spectra were recorded on a Bruker AscendTM 400 series spectrometer. Chemical shift of ^1H NMR spectra were reported upfield in relative to tetramethylsilane (TMS) (δ 0.00 ppm) or dimethyl sulfoxide- d_6 (DMSO- d_6) (δ 2.50 ppm). ^{13}C NMR spectra are referenced in ppm to deuteriochloroform (δ 77.00 ppm), DMSO- d_6 (δ 39.51 ppm).

Infrared (IR) spectra were recorded on an Agilent Cary 630 FTIR spectrophotometer. Samples were analyzed by placing the sample directly onto the crystal of an attenuated total reflectance (ATR) module.

Melting points were determined on a Stuart Scientific SMP3 melting-point apparatus and were uncorrected.

Low-resolution mass spectra were obtained on an Advion expression^S CMS mass spectrometer operating at 3.5 kV in electrospray ionization (ESI) mode.

3.1.3 Chromatography

Dry flash chromatography (DFC) was carried out with a silica gel (Fluka: silica gel 60, particle size 0.040-0.063 mm (230-400 mesh)). Vacuum was created by a water aspirator.

Thin-layer chromatography (TLC) was carried out using silica gel plates from Fluka (silica gel/dc-alufohlen-kieselgel with fluorescent indicator, production number 60778). The spots were detected with UV (extinction at $\lambda = 366$ nm) in a UVP-UV cabinet and/or by staining with MOP (molybdate phosphoric acid (14g) in ethanol (125 mL)) or CER-MOP (molybdate phosphoric acid (5g), cerium (IV)sulphate (2g) and 98% sulfuric acid (16 mL) in water (180 mL) and developed by heating with a heat gun until spots appeared.

Thin-layer chromatography was generally used to monitor reactions. Workup was normally carried out when TLC indicated that all starting material had been consumed or that only traces remained.

3.2 Methods

3.2.1 Synthesis of various acetophenones.

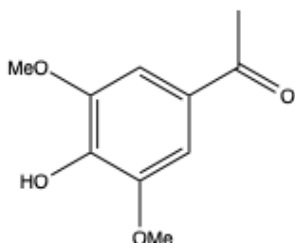
3,5-Dimethoxy-4-hydroxyacetophenone (1); 3,4,5-Trimethoxyacetophenone (2) (10.5 g, 50.0

mmol) was dissolved in anhydrous DCM (200 mL) and aluminium trichloride (20.0 g, 150.0 mmol) was added. The reaction mixture was stirred overnight at room temperature. The reaction was cooled using an ice bath and hydrolysed using AlCl_3 . The pH was adjusted using HCl (12 M). The aqueous phase was extracted using DCM (4 x 40 mL) and the combined organic phases were washed with H_2O (3 x 20 mL) and dried (Na_2SO_4). The crude product was removed under vacuum to yield a light-

yellow powder which was recrystallized from methylcyclohexane to give long straight colourless crystals.

Yield: 7.97 g (80%), mp = 115 - 117 °C (Lit. 117 °C)^[82], R_f = 0.17 (30% MeOAc in petroleum ether). IR (ATR): 3339 (br, OH), 2121, 1460, 1328, 1113, 611 cm^{-1} ; ^1H NMR (400 MHz, CDCl_3): δ 7.23 (s, 2H), 5.75 (s, bs, 1H, OH), 3.83 (s, 6H), 2.52 (s, 3H) ppm; ^{13}C NMR (100 MHz, CDCl_3): δ 196.7, 148.0, 141.4, 127.9, 106.7, 56.5, 26.8 ppm; LRMS (ESI): Calcd for $\text{C}_{10}\text{H}_{11}\text{O}_4$ [M - H⁻] 195.1, found 195.1.

The spectroscopic data was in accordance with literature.^[83 - 84]

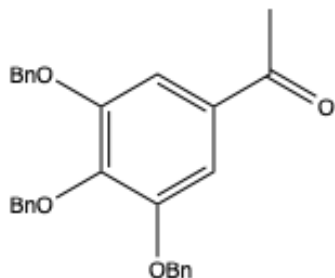
3,4,5-Tribenzyloxyacetophenone (3); 3,4,5-Tribenzyloxybenzoic acid (4) (8.86 g, 20.0 mmol)

was dissolved in THF (200 mL) under a nitrogen atmosphere and the mixture was cooled to 0 °C. MeLi (2 eq., 28.58 mL) was added dropwise over a period of 30 min. The reaction was quenched at completion as indicated by TLC, with H_2O (200 mL) and the aqueous phase was extracted with diethyl ether (4 x 25 mL), the combined organic phases were washed with H_2O (3 x 20 mL) and dried (Na_2SO_4). The crude product was removed under vacuum to yield a white powder which was recrystallized from methylcyclohexane to give white crystals.

Yield: 8.70 g (99%), mp = 116 - 118 °C (Lit. 116 - 117 °C)^[85], R_f = 0.26 (30% MeOAc in petroleum ether). ^1H NMR (400 MHz, CDCl_3): δ 7.44 - 7.26 (m, 17H), 5.15 (s, 4H), 5.14 (s, 2H), 2.50 (s, 3H) ppm; ^{13}C NMR (100 MHz, CDCl_3): δ 196.8, 152.6, 143.0, 136.6, 132.4, 128.6, 127.5, 108.4, 75.2, 71.4, 26.4 ppm.

The NMR data was in accordance with literature.^[85]

3.2.2 Synthesis of acetals.

General procedure for the preparation of dimethyl acetals.

In a typical procedure, the acetophenone (0.1 mol) and trimethyl orthoformate (10.6 g, 0.1 mol) were dissolved in methanol (50 mL). Catalytic amounts of HCl (12 M) was added dropwise and the solution was then refluxed until completion as indicated by TLC. After cooling, the mixture was neutralized with potassium carbonate (K_2CO_3) and filtered. The acetals were then obtained by fractional distillation or by recrystallization from methylcyclohexane. Physical and spectral data for the compounds prepared by this procedure are listed below.

5-(1,1-Dimethoxyethyl)-1,2,3-trimethoxybenzene (5); Starting from 3,4,5-trimethoxyacetophenone (**2**) (22.14 g, 0.1 mol), acetal **5** was prepared and isolated using recrystallization as brown crystals. Yield: 23.74 g (93%), mp = 60 - 61 °C, R_f = 0.42 (30% MeOAc in petroleum ether). IR (ATR): 2939, 1590, 1410, 1333, 1126, 1046, 876 cm^{-1} ; 1H NMR (400MHz, $CDCl_3$): δ 6.72 (s, 2H), 3.88 (s, 6H), 3.33 (s, 3H), 3.20 (s, 6H), 1.53 (s, 3H) ppm; ^{13}C NMR (100 MHz, $CDCl_3$): δ 153.0, 138.9, 137.2, 103.7, 101.6, 60.4, 56.3, 49.0, 26.3 ppm; LRMS (ESI): Calcd for $C_{13}H_{18}O_5Na$ [$M + Na^+ - 2H^-$] 277.2, found 277.2.

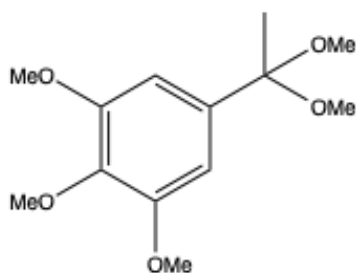

The spectroscopic and spectrophotometric data was in accordance with unpublished work by the Bakstad research group.^[71]

1,1,2,2-Tetramethoxypropane (6); Starting from methylglyoxal 1,1-dimethyl acetal (**7**) (11.81 g, 0.1 mol), acetal **6** was prepared and isolated as a colourless liquid using fractional distillation.

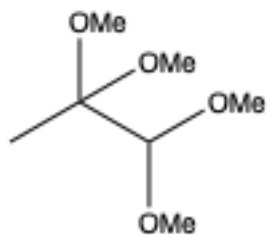

Yield: 13.46 g (82%), bp = 55 - 57 °C/15 torr (Lit. 50 - 52 °C/10 torr)^[86]. IR (ATR): 2948, 1731, 1064, 874 cm^{-1} ; 1H NMR (400 MHz, $CDCl_3$): δ 4.12 (s, 1H), 3.43 (s, 6H), 3.18 (s, 6H), 1.19 (s, 3H) ppm; ^{13}C NMR (100 MHz, $CDCl_3$): δ 105.7, 101.8, 57.2, 48.3, 16.6 ppm; LRMS (ESI): Calcd for $C_7H_{16}O_4Na$ [$M + Na^+$] 187.1, found 187.1.

The spectroscopic data was in accordance with literature.^[86 - 87]

2-(Benzyloxy)-5-(1,1-dimethoxyethyl)-1,3-dimethoxybenzene (8); Starting from 4-benzyloxy-3,5-dimethoxyacetophenone (**9**) (28.63 g, 0.1 mol), acetal **8** was prepared and isolated using recrystallization as yellow crystals.

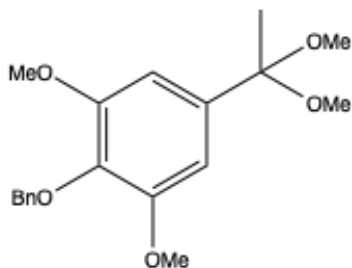

Yield: 21.08 g (63%), mp = 72 - 74 °C, R_f = 0.54 (30% MeOAc in petroleum ether). IR (ATR): 2799, 1681, 1588, 1412, 1330, 1127, 753 cm^{-1} ; 1H NMR (400 MHz, $CDCl_3$): δ 7.49 - 7.44 (m, 2H), 7.35 - 7.25 (m, 3H), 6.71 (s, 2H), 5.09 (s, 2H), 3.87 (s, 6H), 3.18 (s, 6H), 1.52 (s, 3H) ppm; ^{13}C NMR (100 MHz, $CDCl_3$): δ 153.3, 141.4, 137.9, 131.2, 128.4, 128.1, 127.9, 127.7, 105.8,

101.6, 74.9, 56.1, 26.4 ppm; LRMS (ESI): Calcd for $C_{19}H_{23}O_5$ [$M - H^-$] 330.5, found 330.5.

5-(1,1-Dimethoxyethyl)-1,2,3-tribenzyloxybenzene (10); Starting from 3,4,5-tribenzyloxyacetophenone (**3**) (21.92 g, 50.0 mmol), acetal **10** was prepared and isolated using recrystallization as yellow crystals.

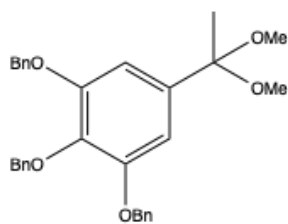

Yield: 16.66 g (69%), mp = 62 - 65 °C, R_f = 0.69 (30% MeOAc in petroleum ether). IR (ATR): 2936, 1590, 1241, 1103, 696 cm^{-1} ; ^1H NMR (400 MHz, CDCl_3): δ 7.44 - 7.24 (m, 15H), 6.81 (s, 2H), 4.97 (s, 4H), 4.96 (s, 2H), 3.33 (s, 6H), 1.28 (s, 3H) ppm; ^{13}C NMR (100 MHz, CDCl_3): δ 160.4, 152.3, 137.1, 128.5, 128.3, 127.5, 105.8, 101.7, 71.1, 57.2, 26.3 ppm; LRMS (ESI): Calcd for $\text{C}_{31}\text{H}_{32}\text{O}_5\text{Na}$ [$\text{M} + \text{Na}^+$] 508.5, found 508.5.

4-(1,1-Dimethoxyethyl)-1,2-dimethoxybenzene (11); Starting from 3,4-dimethoxyacetophenone (**12**) (18.02 g, 0.10 mol), acetal **11** was prepared as an oil and the crude product was essentially pure by NMR.

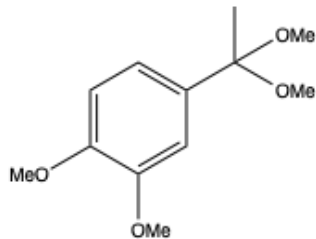

Yield: 22.15 g (98%), R_f = 0.53 (30% MeOAc in petroleum ether). IR (ATR): 2937, 1509, 1264, 1026, 763 cm^{-1} ; ^1H NMR (400 MHz, CDCl_3): δ 7.03 - 7.00 (m, 2H), 6.83 (d, J = 8.4 Hz, 2H), 3.86 (s, 3H), 3.84 (s, 3H), 3.15 (s, 6H), 1.50 (s, 3H) ppm; ^{13}C NMR (100 MHz, CDCl_3): δ 148.4, 148.1, 135.5, 118.4, 110.5, 109.4, 101.4, 55.7, 48.7, 26.0 ppm; LRMS (ESI): Calcd for $\text{C}_{12}\text{H}_{17}\text{O}_4$ [$\text{M} - \text{H}^-$] 224.8, found 224.8.

1-(1,1-Dimethoxyethyl)-4-methoxybenzene (13); Starting from 4-methoxyacetophenone (**14**) (15.02 g, 0.1 mol), acetal **13** was prepared and isolated as a colourless liquid using fractional distillation.

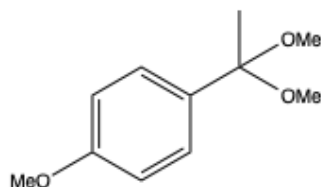

Yield: 19.59 g (100%), bp = 120 - 125 °C/10 torr (Lit. 64 °C/0.15 torr)^[88], R_f = 0.68 (30% MeOAc in petroleum ether). IR (ATR): 2941, 1610, 1509, 1243, 1031, 830 cm^{-1} ; ^1H NMR (400 MHz, CDCl_3): δ 7.40 (d, J = 8.8 Hz, 2H), 6.86 (d, J = 8.8 Hz, 2H), 3.80 (s, 3H), 3.33 (s, 6H), 1.52 (s, 3H) ppm; ^{13}C NMR (100 MHz, CDCl_3): δ 158.8, 134.9, 127.3, 113.1, 101.3, 54.9, 48.6, 25.9 ppm; LRMS (ESI): Calcd for $\text{C}_{11}\text{H}_{15}\text{O}_3$ [$\text{M} - \text{H}^-$] 192.0, found 192.0.

The spectroscopic data was in accordance with literature.^[89-90]

1-(Benzyloxy)-4-(1,1-dimethoxyethyl)-2-methoxybenzene (15); Starting from 4-benzyloxy-3-methoxyacetophenone (**16**) (25.63 g, 0.10 mol), acetal **15** was prepared and isolated using recrystallization as yellow crystals.

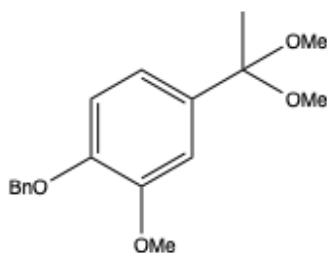

Yield: 28.67 g (95%), mp = 54 - 57 °C, R_f = 0.63 (30% MeOAc in petroleum ether). IR (ATR): 2927, 1510, 1219, 1033, 697 cm^{-1} ; ^1H NMR (400 MHz, CDCl_3): δ 7.45 - 7.25 (m, 5H), 7.06 - 6.97 (m, 2H), 6.86 (d, J = 8.3, 1H), 5.15 (s, 2H), 3.90 (s, 3H), 3.18 (s, 6H), 1.53 (s, 3H) ppm; ^{13}C NMR (100 MHz, CDCl_3): δ 149.2, 147.5, 137.2, 136.1, 128.5, 127.2, 113.3, 110.1, 101.5, 71.0, 56.0, 48.9, 26.1 ppm; LRMS (ESI): Calcd for $\text{C}_{18}\text{H}_{21}\text{O}_4$ [$\text{M} - \text{H}^-$] 300.2, found 300.2.

3.2.3 Synthesis of benzylated compounds.

General procedure for synthesizing benzylated compounds.

A hydroxy acetophenone or aldehyde (0.10 mol) was added to a mixture of benzyl chloride (BnCl, 12.66 g, 0.10 mol), acetonitrile (200 mL), potassium iodide (catalytic amount) and potassium carbonate (13.82 g, 0.10 mol) and heated at reflux until completion as observed by TLC. The reaction mixture was quenched using H₂O (200 mL), the aqueous phase was extracted using tert-butylmethyl ether (4 x 30 mL) and the combined organic phases were washed with H₂O (3 x 15 mL) and dried (Na₂SO₄). The solvent was removed under reduced pressure and the obtained solid was recrystallized from methylcyclohexane to form white crystals. Where multiple hydroxy groups were benzylated the equivalents of BnCl and potassium carbonate was adjusted accordingly. The following compounds were obtained using this general procedure.

4-Benzyloxy-3,5-dimethoxyacetophenone (9); Starting from 3,5-dimethoxy-4-hydroxyacetophenone (**1**) (19.44 g, 0.10 mol) the benzylated acetophenone **9** was prepared.

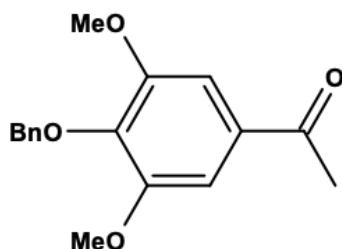

Yield: 25.83 g (90%), mp = 60 - 61 °C, *R_f* = 0.36 (30% MeOAc in petroleum ether). IR (ATR): 2937, 1704, 1581, 1324, 1121, 733 cm⁻¹; ¹H NMR (400 MHz, CDCl₃): δ 7.35 - 7.26 (m, 5H), 7.19 (s, 2H), 5.10 (s, 2H), 3.88 (s, 6H), 2.57 (s, 3H) ppm; ¹³C NMR (100 MHz, CDCl₃): δ 197.8, 153.6, 141.3, 138.2, 133.0, 128.9, 128.7, 128.6, 106.4, 74.7, 56.8,

27.2 ppm; LRMS (ESI): Calcd for C₁₇H₁₈O₄Na [M + Na⁺] 309.2, found 309.2.

The spectroscopic data was in accordance with literature.^[91]

4-Benzyloxy-3-methoxyacetophenone (16); Starting from 4-hydroxy-3-methoxyacetophenone (**17**) (16.62 g, 0.10 mol) the benzylated acetophenone **16** was prepared.

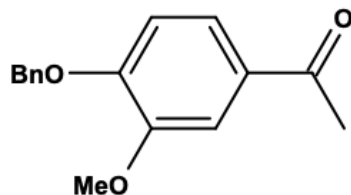

Yield: 18.87 g (74%), mp = 79 - 82 °C, *R_f* = 0.40 (30% MeOAc in petroleum ether). IR (ATR): 2871, 1666, 1509, 1217, 989, 745 cm⁻¹; ¹H NMR (400 MHz, CDCl₃): δ 7.52 - 7.26 (m, 7H), 6.86 (d, *J* = 8.6 Hz, 1H), 5.17 (s, 2H), 3.88 (s, 3H), 2.50 (s, 3H) ppm; ¹³C NMR (100 MHz, CDCl₃): 196.5, 152.1, 149.2, 136.0,

130.4, 128.4, 127.9, 126.9, 122.8, 111.8, 110.2, 70.4, 55.7, 25.9 ppm; LRMS (ESI): Calcd for C₁₈H₂₀O₃N [M + CH₃CN + H⁺] 298.2, found 298.2.

The spectroscopic data was in accordance with literature.^[91 - 93]

4-Benzyloxy-3-methoxybenzaldehyde (18); Starting from 4-hydroxy-3-methoxybenzaldehyde (**19**) (15.2 g, 0.10 mol) the benzylated aldehyde **18** was prepared.

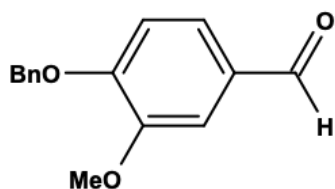

Yield: 20.0 g (63%), mp = 65 - 67 °C (Lit. 74 - 75 °C)^[94], *R_f* = 0.45 (30% MeOAc in petroleum ether). IR (ATR): 2833, 1669, 1498, 1221, 1127, 730 cm⁻¹; ¹H NMR (400 MHz, CDCl₃): δ 9.74 (s, 1H), 7.40 - 7.23 (m, 7H), 6.90 (d, *J* = 8.3 Hz, 1H), 5.16 (s, 2H), 3.78 (s,

3H) ppm; ¹³C NMR (100 MHz, CDCl₃): δ 190.8, 153.5, 150.0, 135.9, 130.2, 128.1, 127.1, 126.5, 112.3, 109.3, 70.8, 56.0 ppm; LRMS (ESI): Calcd for C₁₅H₁₃O₃ [M - H⁻] 247.0, found 247.0.

The spectroscopic data was in accordance with literature.^[91, 94]

3,4-Dibenzyloxybenzaldehyde (20); Starting from 3,4-dihydroxybenzaldehyde (**21**) (13.80 g, 0.10 mol), the benzylated aldehyde **20** was prepared.

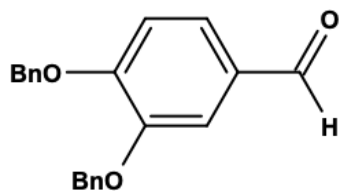

Yield: 26.0 g (82%), mp = 91 - 93 °C (Lit. 93 °C)^[95], R_f = 0.48 (30% MeOAc in petroleum ether). IR (ATR): 3021, 1674, 1266, 1131, 731 cm^{-1} ; ^1H NMR (400 MHz, CDCl_3): δ 9.80 (s, 1H), 7.48 - 7.29 (m, 12H), 7.01 (d, J = 8.3 Hz, 1H), 5.24 (s, 2H), 5.20 (s, 2H) ppm; ^{13}C NMR (100 MHz, CDCl_3): δ 190.7, 154.2, 149.1, 136.5, 136.2, 130.2, 128.6, 128.5, 127.2, 127.0, 126.6,

113.0, 112.3, 70.9, 70.7 ppm; LRMS (ESI): Calcd for $\text{C}_{21}\text{H}_{17}\text{O}_3$ [$\text{M} - \text{H}$] 317.2, found 317.2. The spectroscopic data was in accordance with literature.^[96]

4-Benzyloxybenzaldehyde (22); Starting from 4-hydroxybenzaldehyde (**23**) (12.21 g, 0.10 mol) the benzylated aldehyde **22** was prepared.

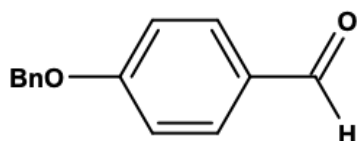

Yield: 17.78 g (84%), mp = 71 - 73 °C (Lit. 73 °C)^[97], R_f = 0.52 (30% MeOAc in petroleum ether). IR (ATR): 2743, 1685, 1253, 1015, 824 cm^{-1} ; ^1H NMR (400 MHz, CDCl_3): δ 9.88 (s, 1H), 7.83 (d, J = 8.6 Hz, 2H), 7.45 - 7.33 (m, 5H), 7.07, (d, J = 8.6 Hz, 2H), 5.15 (s, 2H) ppm; ^{13}C NMR (100

MHz, CDCl_3): δ 190.7, 163.6, 135.9, 131.9, 130.8, 128.6, 127.4, 126.9, 115.1, 70.2 ppm; LRMS (ESI): Calcd for $\text{C}_{28}\text{H}_{24}\text{O}_4\text{Na}$ [$2\text{M} + \text{Na}^+$] 446.9, found 446.9.

The spectroscopic data was in accordance with literature.^[98]

3-Benzyloxybenzaldehyde (24); Starting from 3-hydroxybenzaldehyde (**25**) (12.21 g, 0.10 mol) the benzylated aldehyde **24** was prepared.

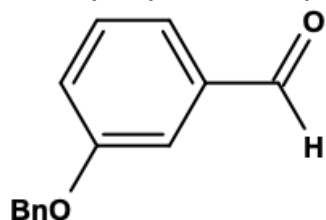

Yield: 18.15 g (86%), mp = 47 - 49 °C (Lit. 57 - 58 °C)^[99], R_f = 0.55 (30% MeOAc in petroleum ether). IR (ATR): 2808, 1692, 1233, 987, 737 cm^{-1} ; ^1H NMR (400 MHz, CDCl_3): δ 9.91 (s, 1H), 7.44 - 7.28 (m, 8H), 7.17 - 7.23 (m, 1H), 5.05 (s, 2H) ppm; ^{13}C NMR (100 MHz, CDCl_3): δ 192.0, 159.2, 137.7, 136.2, 130.0, 127.4, 123.4, 122.1, 113.2, 70.1 ppm; LRMS (ESI): Calcd for

$\text{C}_{28}\text{H}_{24}\text{O}_4\text{Na}$ [$2\text{M} + \text{Na}^+$] 446.9, found 446.9.

The spectroscopic data was in accordance with literature.^[99]

3.2.4 Synthesis of epoxides.

General procedure for the synthesis of epoxides (26), (28), (29), (30) and (31).

A solution containing benzaldehyde (5.0 mmol), anhydrous DME (25 mL) and trimethyl sulfonium iodide (1.02 g, 5.0 mmol) was mixed at 0 °C under nitrogen atmosphere. 50% NaH suspended in mineral oil (0.36 g, 7.5 mmol) was slowly added and the reaction was kept at 0 °C for 2 hours before running until completion at rt. The reaction mixture was quenched by H₂O (25 mL) and Et₂O (4 x 20 mL) was used to extract the aqueous phase. The combined organic layers were washed with H₂O (2 x 15 mL) and dried (Na₂SO₄) before the solvent was removed under reduced pressure.

2-Phenyloxirane (26); Starting from freshly distilled benzaldehyde (**27**) (0.53 g, 5.0 mmol) the epoxide **26** was prepared and isolated as a colourless liquid from fractional distillation.

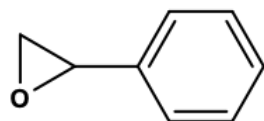

Yield: 0.39 g (65%), bp = 75 - 80 °C/15 torr (Lit. 72 - 73 °C/10 torr)^[100], R_f = 0.71 (30% MeOAc in petroleum ether). IR (ATR): 2817, 1694, 1255, 1255, 1021, 690 cm⁻¹; ¹H NMR (400 MHz, CDCl₃): δ 7.65 - 7.25 (m, 5H), 3.85 (dd, J = 3.2, 2.4 Hz, 1H), 3.14 (dd, J = 5.4, 3.2 Hz, 1H), 2.79 (dd, J = 5.4, 2.4 Hz, 1H) ppm; ¹³C NMR (100 MHz, CDCl₃): δ 137.7, 128.9, 127.5, 125.2, 52.3, 51.1 ppm; LRMS (ESI): Calcd for C₁₀H₁₂ON [M + CH₃CN + H⁺] 162.2, found 162.2.

The spectroscopic data was in accordance with literature.^[101 - 102]

2-(4-(Benzyloxy)phenyl)-oxirane (28); Starting from 4-benzyloxybenzaldehyde (**22**) (1.06 g, 5.0 mmol) the epoxide **28** was prepared and isolated as white crystals using recrystallization from methylcyclohexane.

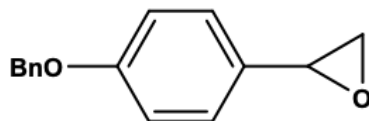

Yield: 1.12 g (99%), mp = 70 - 72 °C, R_f = 0.61 (30% MeOAc in petroleum ether). IR (ATR): 2923, 1510, 1235, 1013, 756 cm⁻¹; ¹H NMR (400 MHz, CDCl₃): δ 7.41 - 7.27 (m, 5H), 7.17 (d, J = 8.7 Hz, 2H), 6.92 (d, J = 8.7 Hz, 2H), 5.08 (s, 2H), 3.77 (dd, J = 3.3, 2.5 Hz, 1H), 3.07 (dd, J = 5.4, 3.3 Hz, 1H), 2.76 (dd, J = 5.4, 2.5 Hz, 1H) ppm; ¹³C NMR (100 MHz, CDCl₃): δ 158.7, 136.7, 128.4, 127.3, 126.7, 114.8, 69.9, 52.0, 50.8 ppm; LRMS (ESI): Calcd for C₁₇H₁₈O₂N [M + CH₃CN + H⁺] 268.0, found 268.0.

The spectroscopic data was in accordance with literature.^[103 - 104]

2-(4-(Benzyloxy)-3-methoxyphenyl)-oxirane (29); Starting from 4-benzyloxy-3-methoxybenzaldehyde (**18**) (1.20 g, 5.0 mmol) the epoxide **29** was prepared and isolated as light yellow crystals using recrystallization from methylcyclohexane.

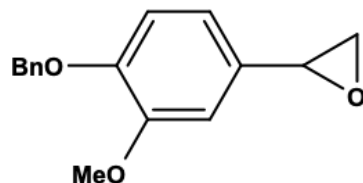

Yield: 0.97 g (75%), mp = 63 - 66 °C, R_f = 0.52 (30% MeOAc in petroleum ether). IR (ATR): 2937, 1511, 1262, 1020, 737 cm⁻¹; ¹H NMR (400 MHz, CDCl₃): δ 7.43 - 7.26 (m, 5H), 6.98 (d, J = 8.3 Hz, 1H), 6.85-6.76 (m, 2H), 5.12 (s, 2H), 3.86 (s, 3H), 3.78 (dd, J = 4.0, 2.4 Hz, 1H), 3.08 (dd, J = 5.5, 4.0 Hz, 1H), 2.75 (dd, J = 5.5, 2.4 Hz, 1H) ppm; ¹³C NMR (100 MHz, CDCl₃): δ 150.1, 148.1, 137.0, 130.3, 128.7, 127.2, 118.3, 114.0, 108.5, 71.1, 56.0, 52.3, 51.0 ppm; LRMS (ESI): Calcd for C₁₆H₁₅O₃ [M - H] 255.1, found 255.1.

The spectroscopic data was in accordance with literature.^[92]

2-(3-(Benzyloxy)phenyl)-oxirane (30); Starting from 3-benzyloxybenzaldehyde (**24**) (1.06 g, 5.0 mmol) the epoxide **30** was prepared and isolated as light yellow crystals using recrystallization from methylcyclohexane.

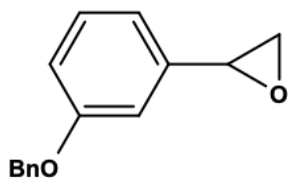

Yield: 0.85 g (75%), mp = 51 - 52 °C, R_f = 0.74 (30% MeOAc in petroleum ether). IR (ATR): 2875, 1584, 1448, 1236, 1026, 1026, 693 cm^{-1} ; ^1H NMR (400 MHz, CDCl_3): δ 7.42 - 7.22 (m, 6H), 6.91-6.88 (m, 3H), 5.03 (s, 2H), 3.81 (dd, J = 4.1, 3.0 Hz, 1H), 3.09 (dd,

J = 5.6, 4.1 Hz, 1H), 2.73 (dd, J = 5.6, 3.0 Hz, 1H) ppm; ^{13}C NMR (100 MHz, CDCl_3): δ 159.0, 139.3, 136.8, 129.5, 128.4, 127.3, 118.1, 114.6, 111.4, 69.8, 52.1, 51.0 ppm; LRMS (ESI): Calcd for $\text{C}_{17}\text{H}_{18}\text{O}_2\text{N}$ [$\text{M} + \text{CH}_3\text{CN} + \text{H}^+$] 268.0, found 268.0.

The spectroscopic data was in accordance with literature.^[105]

2-(3,4-(Dibenzyloxy)phenyl)-oxirane (31); Starting from 3,4-dibenzyloxybenzaldehyde (**20**) (1.59 g, 5.0 mmol) the epoxide **31** was prepared and isolated as white crystals using recrystallization from methylcyclohexane.

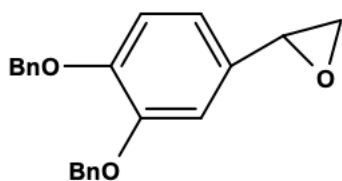

Yield: 1.10 g (65%), mp = 40 - 41 °C (Lit. 40 - 41 °C)^[106], R_f = 0.64 (30% MeOAc in petroleum ether). IR (ATR): 2820, 1675, 1513, 1258, 1022, 726 cm^{-1} ; ^1H NMR (400 MHz, CDCl_3): δ 7.48 - 7.30 (m, 10H), 7.01 (d, J = 8.3 Hz, 1H), 6.86 - 6.83 (m, 2H), 5.23 (s, 2H), 5.20 (s, 2H), 3.74 (dd, J = 4.2, 3.3 Hz, 1H),

3.05 (dd, J = 5.4, 4.2 Hz, 1H), 2.68 (dd, J = 5.4, 3.3 Hz, 1H) ppm; ^{13}C NMR (100 MHz, CDCl_3): δ 149.1, 148.9, 137.1, 130.7, 128.3, 127.7, 127.2, 119.0, 114.9, 111.7, 71.1, 52.1, 50.9 ppm; LRMS (ESI): Calcd for $\text{C}_{22}\text{H}_{17}\text{O}_2$ [$\text{M} - \text{H}_2\text{O} - \text{H}^-$] 264.8, found 264.8.

The spectroscopic data was in accordance with literature.^[107]

General procedure for the synthesis of epoxide (32) and (34).

A styrene (50.0 mmol), DCM (150 mL) and *meta*-chloroperoxybenzoic acid (*m*-CPBA, 12.94 g, 75.0 mmol) was stirred at 0 °C for 2 hours then left to completion at rt. The reaction was quenched with H_2O (150 mL), the aqueous phase was extracted using DCM (4 x 20 mL) and the combined organic phases were washed with H_2O (2 x 15 mL), dried (Na_2SO_4) and concentrated *in vacuo*.

2-(*p*-Tolyl)-oxirane (32); Starting from 4-methylstyrene (**33**) (5.91 g, 50.0 mmol) the epoxide **32** was prepared and isolated as a light-yellow oil using dry flash chromatography (DFC) (PE/EtOAc, 9/1).

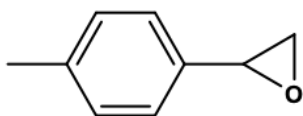

Yield: 4.27 g (64%), R_f = 0.89 (30% MeOAc in petroleum ether). IR (ATR): 1709, 1252, 1072, 747 cm^{-1} ; ^1H NMR (400 MHz, CDCl_3): δ 7.36 - 7.06 (m, 4H), 3.77 (dd, J = 4.0, 2.4 Hz, 1H), 3.03

(dd, J = 5.3, 4.0 Hz, 1H), 2.74 (dd, J = 5.3, 2.4 Hz, 1H), 2.30 (s, 3H) ppm; ^{13}C NMR (100 MHz, CDCl_3): δ 138.5, 135.0, 129.7, 125.6, 52.4, 51.1, 21.1 ppm; LRMS (ESI): Calcd for $\text{C}_9\text{H}_8\text{ONa}$ [$\text{M} + \text{Na}^+ - 2\text{H}^-$] 155.0, found 155.0.

The spectroscopic data was in accordance with literature.^[108]

2-(4-(*Tert*-butyl)phenyl)-oxirane (34); Starting from 4-*tert*-butylstyrene (**35**) (8.00 g, 50.0 mmol) the epoxide **34** was prepared and isolated as a light-yellow oil using DFC (PE/EtOAc, 9/1).

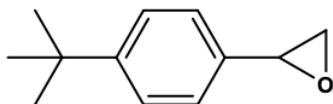

Yield: 7.20 g (82%), $R_f = 0.91$ (30% MeOAc in petroleum ether). IR (ATR): 2946, 1725, 1255, 1022, 751 cm^{-1} ; $^1\text{H NMR}$ (400 MHz, CDCl_3): δ 7.43 - 7.21 (m, 4H), 3.86 (dd, $J = 4.1, 2.7$ Hz, 1H), 3.15 (dd, $J = 5.3, 4.1$ Hz, 1H), 2.83 (dd, $J = 5.3, 2.7$ Hz, 1H), 1.32 (s, 9H) ppm; $^{13}\text{C NMR}$ (100 MHz, CDCl_3): δ 151.7, 136.6, 125.9, 125.4, 52.3, 51.0, 34.6, 31.3 ppm; LRMS (ESI): Calcd for $\text{C}_{12}\text{H}_{14}\text{ONa}$ [$\text{M} + \text{Na}^+ - 2\text{H}^-$] 197.0, found 197.0.

The spectroscopic data was in accordance with literature.^[109]

3.2.5 Synthesis of methoxy alcohols.

General procedure for the synthesis of methoxy alcohols.

An epoxide (10.0 mmol) was added to a solution of MeOH (60 mL) and $\text{BF}_3 \cdot \text{OEt}_2$ (1 mL) under N_2 atmosphere at 0 °C for 2 hours then left to completion at rt. The solution was quenched with saturated aqueous NaHCO_3 (60 mL) before the combined organic phases were extracted with Et_2O (4 x 30 mL), washed with H_2O (3 x 15 mL) and dried (Na_2SO_4). The solvent was removed under reduced pressure.

2-Methoxy-2-phenylethan-1-ol (36); Starting from 2-phenyl oxirane (**26**) (1.20 g, 10.0 mmol) the methoxy alcohol **36** was prepared and isolated as a colourless liquid using fractional distillation.

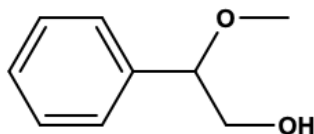

Yield: 13.75 g (90%), bp = 102 - 104 °C/10 torr (Lit. 108 - 113 °C/6 torr)^[110], $R_f = 0.45$ (30% MeOAc in petroleum ether). IR (ATR): 3428 (br, OH), 2930, 1453, 1108, 1025, 699 cm^{-1} ; $^1\text{H NMR}$ (400 MHz, CDCl_3): δ 7.36 - 7.25 (m, 5H), 4.30 (dd, $J = 8.3, 3.7$ Hz, 1H), 3.69 (d, $J = 8.3$ Hz, 2H), 3.28 (s, 3H) ppm; $^{13}\text{C NMR}$ (100 MHz, CDCl_3): δ 138.2, 128.4, 126.7, 84.8, 67.1, 56.7 ppm; LRMS (ESI): Calcd for $\text{C}_9\text{H}_{11}\text{O}_2$ [$\text{M} - \text{H}^-$] 151.1, found 151.1.

The spectroscopic data was in accordance with literature.^[111]

2-(4-(Benzyloxy)phenyl)-2-methoxyethan-1-ol (37); Starting from 2-(4-(benzyloxy)phenyl) oxirane (**28**) (2.20 g, 10.0 mmol) the methoxy alcohol **37** was prepared and isolated as white crystals using recrystallization from methylcyclohexane.

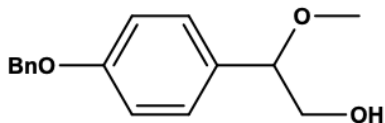

Yield: 1.79 g (69%), mp = 53 - 55 °C (Lit. 49 - 53 °C)^[112], $R_f = 0.25$ (30% MeOAc in petroleum ether). IR (ATR): 3408 (br, OH), 2939, 1508, 1330, 1167, 961, 736 cm^{-1} ; $^1\text{H NMR}$ (400 MHz, CDCl_3): δ 7.44 - 7.21 (m, 5H), 6.96 (d, $J = 8.6$ Hz, 2H), 6.83 (d, $J = 8.6$ Hz, 2H), 5.05 (s, 2H), 4.24 (dd, $J = 8.6, 3.9$ Hz, 1H), 3.47 (d, $J = 7.1$ Hz, 1H), 3.33 (d, $J = 7.1$ Hz, 1H), 3.27 (s, 3H) ppm; $^{13}\text{C NMR}$ (100 MHz, CDCl_3): δ 158.7, 136.8, 130.5, 128.5, 128.1, 127.4, 114.8, 84.1, 70.0, 67.2, 56.6 ppm; LRMS (ESI): Calcd for $\text{C}_{32}\text{H}_{37}\text{O}_6$ [$2\text{M} + \text{H}^+$] 517.4, found 517.4.

The spectroscopic data values were in accordance with literature.^[112]

2-(3,4-(Dibenzyloxy)phenyl)-2-methoxyethan-1-ol (38); Starting from 2-(3,4-(dibenzyloxy)phenyl) oxirane (**31**) (3.62 g, 10.0 mmol) the methoxy alcohol **38** was prepared and isolated as white crystals using recrystallization from methylcyclohexane.

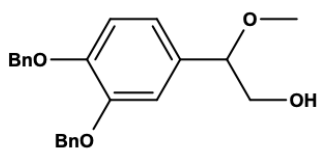

Yield: 3.64 g (99%), mp = 51 - 54 °C, R_f = 0.17 (30% MeOAc in petroleum ether). IR (ATR): 3387 (br, OH), 2861, 1516, 1260, 1029, 730 cm^{-1} ; ^1H NMR (400 MHz, CDCl_3): δ 7.46 - 7.43 (m, 4H), 7.38 - 7.28 (m, 6H), 6.90 - 6.85 (m, 2H), 6.80 (d, J = 8.4 Hz, 1H), 5.17 (s, 2H), 5.15 (s, 2H), 4.18 (dd, J = 8.4, 1.7 Hz, 1H), 3.54 (s, 1H), 3.39 (s, 1H), 3.22 (s, 3H) ppm; ^{13}C NMR (100 MHz, CDCl_3): δ 148.9, 137.1, 131.4, 128.5, 127.4, 127.2, 120.2, 114.8, 113.6, 84.1, 71.3, 67.3, 56.7 ppm; LRMS (ESI): Calcd for $\text{C}_{23}\text{H}_{22}\text{O}_4\text{Na}$ [$\text{M} + \text{Na}^+ - 2\text{H}^+$] 385.1, found 385.1.

2-(4-(Benzyloxy)-3-methoxyphenyl)-2-methoxyethan-1-ol (39); Starting from 2-(4-(benzyloxy)-3-methoxyphenyl) oxirane (**29**) (2.57 g, 10.0 mmol) the methoxy alcohol **39** was prepared and isolated as white crystals using recrystallization from methylcyclohexane.

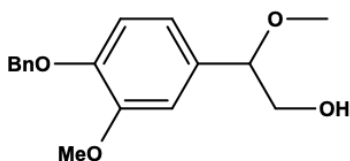

Yield: 2.13 g (74%), mp = 60 - 63 °C, R_f = 0.23 (30% MeOAc in petroleum ether). IR (ATR): 3430 (br, OH), 2928, 1513, 1258, 1022, 908, 726 cm^{-1} ; ^1H NMR (400 MHz, CDCl_3): δ 7.44 - 7.25 (m, 5H), 6.85 (d, J = 8.3 Hz, 1H), 6.82 - 6.77 (m, 2H), 5.13 (s, 2H), 4.23 (dd, J = 8.3, 2.2 Hz, 1H), 3.88 (s, 3H), 3.65 (d, J = 8.3 Hz, 2H), 3.28 (s, 3H) ppm; ^{13}C NMR (100 MHz, CDCl_3): δ 149.7, 148.0, 137.0, 131.3, 128.4, 127.7, 119.3, 113.7, 110.0, 84.3, 70.9, 67.2, 56.7, 55.9 ppm; LRMS (ESI): Calcd for $\text{C}_{34}\text{H}_{41}\text{O}_8$ [$2\text{M} + \text{H}^+$] 577.2, found 577.2.

2-(3-(Benzyloxy)phenyl)-2-methoxyethan-1-ol (40); Starting from 2-(3-(benzyloxy)phenyl) oxirane (**30**) (2.20 g, 10.0 mmol) the methoxy alcohol **40** was prepared and isolated as white crystals using recrystallization from methylcyclohexane.

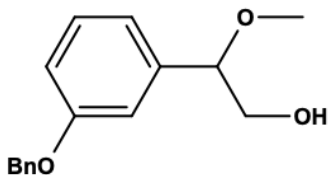

Yield: 1.75 g (68%), mp = 73 - 76 °C, R_f = 0.27 (30% MeOAc in petroleum ether). IR (ATR): 3402 (br, OH), 2873, 1592, 1235, 1015, 685 cm^{-1} ; ^1H NMR (400 MHz, CDCl_3): δ 7.46 - 7.36 (m, 6H), 6.95 - 6.89 (m, 3H), 5.07 (s, 2H), 4.28 (dd, J = 8.1, 4.1 Hz, 1H), 3.63 (d, J = 4.1 Hz, 2H), 3.31 (s, 3H) ppm; ^{13}C NMR (100 MHz, CDCl_3): δ 159.1, 140.0, 136.8, 129.6, 127.5, 119.5, 114.4, 113.2, 84.4, 70.0, 67.4, 57.0 ppm; LRMS (ESI): Calcd for $\text{C}_{32}\text{H}_{37}\text{O}_6$ [$2\text{M} + \text{H}^+$] 517.4, found 517.4.

2-Methoxy-2-(p-tolyl)ethan-1-ol (41); Starting from 2-(p-tolyl) oxirane (**32**) (1.40 g, 10.0 mmol) the methoxy alcohol **41** was prepared and isolated as a yellow powder using DFC (PE/EtOAc, 8/2).

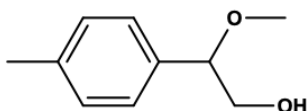

Yield: 1.40 g (84%), mp = 57 - 59 °C, R_f = 0.56 (30% MeOAc in petroleum ether). IR (ATR): 3520 (br, OH), 2954, 1702, 1259, 1051, 745 cm^{-1} ; ^1H NMR (400 MHz, CDCl_3): δ 7.29 - 7.20 (m, 4H), 4.82 (dd, J = 8.3, 4.3 Hz, 2H), 4.37 (dd, J = 8.3, 4.3 Hz, 1H), 3.23 (s, 3H), 2.42 (s, 3H) ppm; ^{13}C NMR (100 MHz, CDCl_3): δ 137.8, 135.7, 129.2, 126.5, 81.2, 65.6, 56.8, 21.0 ppm; LRMS (ESI): Calcd for $\text{C}_{20}\text{H}_{29}\text{O}_4$ [$2\text{M} + \text{H}^+$] 333.3, found 333.3.

The spectroscopic data was in accordance with literature.^[111]

2-(4-(*Tert*-butyl)phenyl)-2-methoxyethan-1-ol (42); Starting from 2-(4-(*tert*-butyl)phenyl) oxirane (**34**) (1.80 g, 10.0 mmol) the methoxy alcohol **42** was prepared and isolated as a yellow powder using DFC (PE/EtOAc, 8/2).

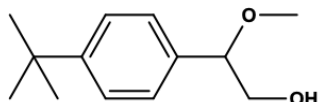

Yield: 1.18 g (57%), mp = 124 - 126 °C, R_f = 0.61 (30% MeOAc in petroleum ether). IR (ATR): 3338 (br, OH), 2957, 1459, 1227, 1032, 828, 702 cm^{-1} ; ^1H NMR (400 MHz, CDCl_3): δ 7.40-7.33 (m, 4H), 4.61 (dd, J = 7.1, 2.3 Hz, 1 H), 3.88 (d, J = 7.1 Hz, 2H), 3.36 (s, 3H), 1.29 (s, 9H) ppm; ^{13}C NMR (100 MHz, CDCl_3): δ 151.0, 137.5, 125.8, 125.5, 74.5, 72.3, 67.9, 56.3, 34.5, 31.3 ppm; LRMS (ESI): Calcd for $\text{C}_{13}\text{H}_{19}\text{O}_2$ [$\text{M} - \text{H}^-$] 206.6, found 206.6.

The molecule is described, but no spectroscopic or physical data is supplemented.^[113]

3.2.6 Synthesis of mesylates.

General procedure for synthesizing mesylates.

A methoxy alcohol (10.0 mmol), DCM (100 mL), MsCl (1.70 g, 15.0 mmol) and triethylamine (1.50 g, 15.0 mmol) were mixed together at 0 °C under a nitrogen atmosphere and left to progress towards room temperature overnight. The reaction was quenched with H_2O (100 mL) and the aqueous phase was extracted with DCM (4 x 20 mL). Concomitantly the combined organic layers were washed with H_2O (3 x 15 mL), dried (Na_2SO_4), and the solvent was removed under reduced pressure.

2-Methoxy-2-phenylethyl methanesulfonate (43); Starting from 2-methoxy-2-phenylethan-1-ol (**36**) (1.60 g, 10.0 mmol) the mesylate **43** was prepared and the crude product was essentially pure by NMR.

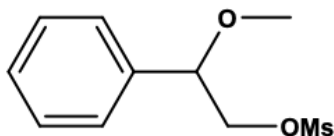

Yield: 1.05 g (92%), bp = 63 - 64 °C/15 torr (Lit. 84 °C/55 torr), R_f = 0.64 (30% MeOAc in petroleum ether). IR (ATR): 2940, 1351, 1172, 960, 702 cm^{-1} ; ^1H NMR (400 MHz, CDCl_3): δ 7.41 - 7.29 (m, 5H), 4.49 (dd, J = 8.1, 3.4 Hz, 1H), 4.31 - 4.27 (m, 1H), 4.22 - 4.19 (m, 1H), 3.30 (s, 3H), 2.98 (s, 3H) ppm; ^{13}C NMR (100 MHz, CDCl_3): δ 136.4, 128.7, 126.8, 81.3, 72.6, 56.8, 37.4 ppm; LRMS (ESI): Calcd for $\text{C}_{10}\text{H}_{12}\text{O}_4\text{SNa}$ [$\text{M} + \text{Na}^+ - 2\text{H}^-$] 251.1, found 251.1.

The spectroscopic data was in accordance with literature.^[114]

2-(4-(Benzyloxy)phenyl)-2-methoxyethyl methanesulfonate (44); Starting from 2-(4-(benzyloxy)phenyl)-2-methoxyethan-1-ol (**37**) (2.58 g, 10.0 mmol) the mesylate **44** was prepared and isolated as white crystals using recrystallization from methylcyclohexane.

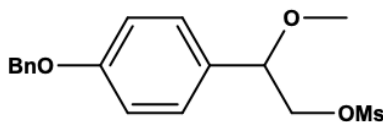

Yield: 2.85 g (85%), mp = 85 - 88 °C (Lit. 91 - 93 °C)^[112], R_f = 0.32 (30% MeOAc in petroleum ether). IR (ATR): 2939, 1514, 1335, 1171, 948, 744 cm^{-1} ; ^1H NMR (400 MHz, CDCl_3): δ 7.44 - 7.33 (m, 5H), 7.25 (d, J = 8.6 Hz, 2H), 6.98 (d, J = 8.6 Hz, 2H), 5.07 (s, 2H), 4.29 - 4.19 (m, 3H), 3.21 (s, 3H), 3.01 (s, 3H) ppm; ^{13}C NMR (100 MHz, CDCl_3): δ 159.1, 136.7, 128.6, 128.6, 127.4, 115.1, 80.9, 72.7, 70.0, 56.7, 55.4, 37.6, 36.5 ppm; LRMS (ESI): Calcd for $\text{C}_{17}\text{H}_{17}\text{O}_4\text{S}$ [$\text{M} - \text{H}_2\text{O} - \text{H}^-$] 317.1, found 317.1.

The spectroscopic data was in accordance with literature.^[112]

2-(3,4-(Dibenzoyloxy)phenyl)-2-methoxyethyl methanesulfonate (45); Starting from 2-(3,4-(dibenzoyloxy)phenyl)-2-methoxyethan-1-ol (**38**) (3.64 g, 10.0 mmol) the mesylate **45** was prepared and isolated as pink crystals using recrystallization from methylcyclohexane.

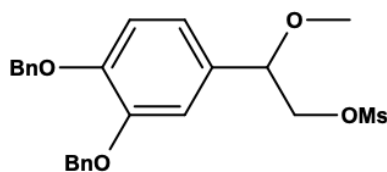

Yield: 3.72 g (84%), mp = 87 - 89 °C, R_f = 0.29 (30% MeOAc in petroleum ether). IR (ATR): 2937, 1507, 1351, 1171, 957, 697 cm^{-1} ; ^1H NMR (400 MHz, CDCl_3): δ 7.45 - 7.30 (m, 10H), 6.92 (d, J = 8.3 Hz, 1H), 6.91 (d, J = 2.0 Hz, 1H), 6.82 (dd, J = 8.3, 2.0 Hz, 1H), 5.17 (s, 2H), 5.16 (s, 2H), 4.37 - 4.14 (m, 3H), 3.22 (s, 3H), 2.94 (s, 3H) ppm; ^{13}C NMR (100 MHz, CDCl_3): δ 149.3, 137.0, 129.5, 128.5, 127.4, 120.4, 114.8, 113.5, 81.0, 72.7, 71.3, 56.8, 37.6 ppm; LRMS (ESI): Calcd for $\text{C}_{24}\text{H}_{26}\text{O}_6\text{SNa}$ [$\text{M} + \text{Na}^+$] 466.3, found 466.3.

2-(4-(Benzyloxy)-3-methoxyphenyl)-2-methoxyethyl methanesulfonate (46); Starting from 2-(4-(benzyloxy)-3-methoxyphenyl)-2-methoxyethan-1-ol (**39**) (2.88 g, 10.0 mmol) the mesylate **46** was prepared and isolated as pink crystals using recrystallization from methylcyclohexane.

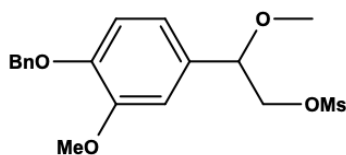

Yield: 2.40 g (65%), mp = 79 - 82 °C, R_f = 0.21 (30% MeOAc in petroleum ether). IR (ATR): 2942, 1516, 1335, 1179, 985, 807 cm^{-1} ; ^1H NMR (400 MHz, CDCl_3): δ 7.45 - 7.31 (m, 5H), 6.88 (d, J = 8.3 Hz, 1H), 6.86 (d, J = 2.0 Hz, 1H), 6.80 (dd, J = 8.3, 2.0 Hz, 1H), 5.16 (s, 2H), 4.42 - 4.20 (m, 3H), 3.91 (s, 3H), 3.29 (s, 3H), 3.00 (s, 3H) ppm; ^{13}C NMR (100 MHz, CDCl_3): δ 150.1, 136.9, 129.4, 128.6, 127.2, 119.6, 113.9, 110.0, 81.2, 72.8, 71.0, 56.9, 56.1, 37.7 ppm; LRMS (ESI): Calcd for $\text{C}_{19}\text{H}_{23}\text{O}_8\text{S}$ [$\text{M} + \text{CH}_2\text{O}_2 - \text{H}$] 410.8, found 410.8.

2-(3-(Benzyloxy)phenyl)-2-methoxyethyl methanesulfonate (47); Starting from 2-(3-(benzyloxy)phenyl)-2-methoxyethan-1-ol (**40**) (2.58 g, 10.0 mmol) the mesylate **47** was prepared and isolated as yellow crystals using recrystallization from methylcyclohexane.

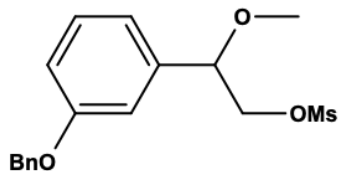

Yield: 3.16 g (94%), mp = 71 - 74 °C, R_f = 0.46 (30% MeOAc in petroleum ether). IR (ATR): 2939, 1585, 1350, 1170, 960, 696 cm^{-1} ; ^1H NMR (400 MHz, CDCl_3): δ 7.45 - 7.23 (m, 6H), 6.99 - 6.86 (m, 3H), 5.07 (s, 2H), 4.56 - 4.46 (m, 3H), 3.73 (s, 3H), 2.58 (s, 3H) ppm; ^{13}C NMR (100 MHz, CDCl_3): δ 159.0, 136.8, 129.6, 128.5, 128.0, 119.5, 113.1, 81.4, 72.7, 70.0, 56.9, 37.6 ppm; LRMS (ESI): Calcd for $\text{C}_{17}\text{H}_{20}\text{O}_5\text{SNa}$ [$\text{M} + \text{Na}^+$] 359.3, found 359.3.

2-Methoxy-2-(p-tolyl)ethyl methanesulfonate (48); Starting from 2-methoxy-2-(p-tolyl)ethan-1-ol (**41**) (1.66 g, 10.0 mmol) the mesylate **48** was prepared and isolated as a yellow oil using DFC (PE/EtOAc, 9/1).

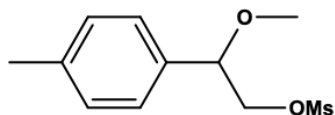

Yield: 2.31 g (95%), R_f = 0.73 (30% MeOAc in petroleum ether). IR (ATR): 1723, 1172, 962, 744 cm^{-1} ; ^1H NMR (400 MHz, CDCl_3): δ 7.42 - 7.28 (m, 4H), 4.61 - 4.50 (m, 1H), 3.66 (s, 3H), 2.99 (s, 3H), 2.15 (s, 3H) ppm; ^{13}C NMR (100 MHz, CDCl_3): δ 139.1, 134.3, 129.4, 126.6, 77.7, 73.8, 56.4, 37.6, 21.0 ppm; LRMS (ESI): Calcd for $\text{C}_{11}\text{H}_{15}\text{O}_4\text{S}$ [$\text{M} - \text{H}^-$] 242.8, found 242.8.

2-(4-(*Tert*-butyl)phenyl)-2-methoxyethyl methanesulfonate (49); Starting from 2-(4-(*tert*-butyl)phenyl)-2-methoxyethan-1-ol (**42**) (2.08 g, 10.0 mmol) the mesylate **49** was prepared and isolated as a yellow oil using DFC (PE/EtOAc, 9/1).

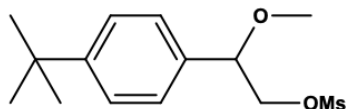

Yield: 2.77 g (97%), $R_f = 0.81$ (30% MeOAc in petroleum ether). IR (ATR): 2960, 1724, 1353, 1171, 964, 808 cm^{-1} ; $^1\text{H NMR}$ (400 MHz, CDCl_3): δ 7.44 - 7.12 (m, 4H), 4.62 - 4.51 (m, 3H), 3.66 (s, 3H), 2.95 (s, 3H), 1.30 (s, 9H) ppm; $^{13}\text{C NMR}$ (100 MHz, CDCl_3): δ 134.5, 126.6, 125.8, 70.2, 56.8, 37.5, 34.5, 31.2 ppm; LRMS (ESI): Calcd for $\text{C}_{15}\text{H}_{23}\text{O}_6\text{S}$ [$\text{M} + \text{CH}_2\text{O}_2 - \text{H}^-$] 331.1, found 331.1.

3.2.7 Synthesis of vinyl ethers.

General procedure for the synthesis of vinyl ethers (50), (51) and method A for (52).

Ammonium dihydrogen phosphate (1.70 g) was added to an acetal (0.10 mol) and heated to 160 °C. Methanol was removed from solution to move the equilibrium towards the product. When no more methanol could be removed, the reaction was cooled, and the product was obtained by fractional distillation under vacuum or by recrystallization from methylcyclohexane.

2,3,3-Trimethoxyprop-1-ene (50); Starting from 1,1,2,2-tetramethoxypropane (**6**) (16.29 g, 0.10 mol) the vinyl ether **50** was prepared and isolated as a colourless liquid using fractional distillation.

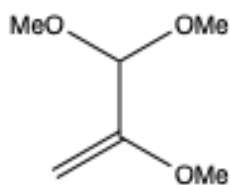

Yield: 11.38 g (94%), bp = 63 - 64 °C/15 torr (Lit. 84 °C/55 torr)^[115]. IR (ATR): 2949, 1453, 1086, 872 cm^{-1} ; $^1\text{H NMR}$ (400 MHz, CDCl_3): δ 4.62 (s, 1H), 4.34 (s, 1H), 4.13 (s, 1H), 3.55 (s, 3H), 3.29 (s, 6H) ppm; $^{13}\text{C NMR}$ (100 MHz, CDCl_3): δ 158.2, 105.2, 83.6, 56.7, 52.5 ppm; LRMS (ESI): Calcd for $\text{C}_6\text{H}_{11}\text{O}_3$ [$\text{M} - \text{H}^-$] 131.2, found 131.2.

The spectroscopic data was in accordance with literature.^[86, 115]

1,2,3-Trimethoxy-5-(1-methoxyvinyl)benzene (51); Starting from 5-(1,1-dimethoxyethyl)-1,2,3-trimethoxybenzene (**5**) (25.69 g, 0.10 mol) the vinyl ether **51** was prepared and isolated as light-yellow crystals using recrystallization.

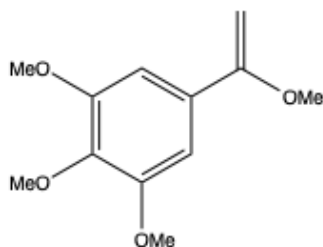

Yield: 14.8 g (66%), mp = 40 - 43 °C, $R_f = 0.56$ (30% MeOAc in petroleum ether). IR (ATR): 2939, 1579, 1411, 1333, 1228, 1123 cm^{-1} ; $^1\text{H NMR}$ (400 MHz, CDCl_3): δ 6.81 (d, $J = 8.3$ Hz, 2H), 4.59 (d, $J = 2.3$ Hz, 1H), 4.20 (d, $J = 2.3$ Hz, 1H), 3.88 (s, 6H), 3.85 (s, 3H), 3.74 (s, 3H) ppm; $^{13}\text{C NMR}$ (100 MHz, CDCl_3): δ 159.9, 153.0, 132.0, 103.0, 82.9, 60.5, 56.3, 55.7 ppm; LRMS (ESI): Calcd for $\text{C}_{12}\text{H}_{15}\text{O}_4$ [$\text{M} - \text{H}^-$] 224.3, found 224.3.

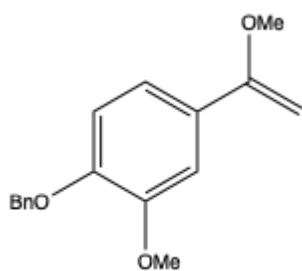
1-(Benzyloxy)-2-methoxy-4-(1-methoxyvinyl)benzene (52);

Method A: Ammonium dihydrogen phosphate (1.70 g) was added to 1-(benzyloxy)-4-(1,1-dimethoxyethyl)-2-methoxybenzene (**15**) (30.27 g, 0.10 mol) and heated to 160 °C. Methanol was removed from solution to move the equilibrium towards the product. When no more methanol could be removed, the reaction was cooled and the vinyl ether **52** was prepared and isolated as yellow crystals using recrystallization. Yield: 17.33 g (57%).

Method B: 2-(4-(benzyloxy)-3-methoxyphenyl)-2-methoxyethyl methanesulfonate (**46**) (3.66 g, 10.0 mmol) was solved in 1,2-dimethoxy ethane (DME, 50 mL) and *t*-BuOK (1.7 g, 15 mmol) was added carefully to the solution at 0 °C under a nitrogen atmosphere. The solution was kept at 0 °C for 2 hours before allowing the mixture to warm to rt where it was left stirring overnight. The mixture was quenched with H₂O (50 mL), the aqueous phase was extracted with Et₂O (4 x 20 mL) and the combined organic phases were washed with H₂O (2 x 15 mL) and dried (Na₂SO₄). The solvent was removed under reduced pressure. The vinyl ether **52** was prepared and isolated as yellow crystals using recrystallization from methylcyclohexane. Yield: 2.62 g (97%).

Mp = 89 - 91 °C, *R_f* = 0.31 (30% MeOAc in petroleum ether). IR (ATR): 2921, 1508, 1258, 1024, 695 cm⁻¹; ¹H NMR (400 MHz, CDCl₃): δ 7.62 - 7.05 (m, 7H), 6.82 (d, *J* = 8.3 Hz, 1H), 5.15 (s, 2H), 4.56 - 4.53 (m, 1H), 4.14 - 4.13 (m, 1H), 3.89 (s, 3H), 3.71 (s, 3H) ppm; ¹³C NMR (100 MHz, CDCl₃): δ 160.6, 149.2, 148.4, 137.1, 131.7, 128.7, 128.5, 127.2, 118.0, 113.5, 109.2, 80.6, 70.9, 55.9, 55.2 ppm; LRMS (ESI): Calcd for C₁₇H₁₇O₃ [M - H]⁻ 270.3, found 270.3.

General procedure for the synthesis of vinyl ethers (53), (54), (55), (56), (57), (58) and method B for (52).

A mesylated compound (10.0 mmol) was solved in DME (50 mL) and *t*-BuOK (1.7 g, 15 mmol) was added carefully to the solution at 0 °C under a nitrogen atmosphere. The solution was kept at 0 °C for 2 hours before allowing the mixture to warm to rt where it was left stirring overnight. The mixture was quenched with H₂O (50 mL), the aqueous phase was extracted with Et₂O (4 x 20 mL) and the combined organic phases were washed with H₂O (2 x 15 mL) and dried (Na₂SO₄). The solvent was removed under reduced pressure.

(1-Methoxyvinyl)benzene (53); Starting from 2-methoxy-2-phenylethyl methanesulfonate (**43**) (2.30 g, 10.0 mmol) the vinyl ether **53** was prepared and isolated as a colourless liquid using fractional distillation.

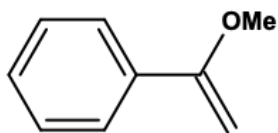

Yield: 1.12 g (84%), bp = 82 - 84 °C/15 torr (Lit. 89 - 90 °C/20 torr)^[20], *R_f* = 0.74 (30% MeOAc in petroleum ether). IR (ATR): 2953, 1573, 1302, 1045, 769, 687 cm⁻¹; ¹H NMR (400 MHz, CDCl₃): δ 7.65 - 7.62 (m, 2H), 7.38 - 7.32 (m, 3H), 4.68 (d, *J* = 2.4

Hz, 1H), 4.24 (d, *J* = 2.4 Hz, 1H), 3.76 (s, 3H) ppm; ¹³C NMR (100 MHz, CDCl₃): δ 160.8, 136.4, 128.4, 125.3, 81.7, 55.2 ppm; LRMS (ESI): Calcd for C₉H₉O [M - H]⁻ 133.2, found 133.2.

The spectroscopic data was in accordance with literature.^[77, 116]

1-(Benzyloxy)-4-(1-methoxyvinyl)benzene (54); Starting from 2-(4-(benzyloxy)phenyl)-2-methoxyethyl methanesulfonate (**44**) (3.36 g, 10.0 mmol) the vinyl ether **54** was prepared and isolated as white crystals using recrystallization from methylcyclohexane.

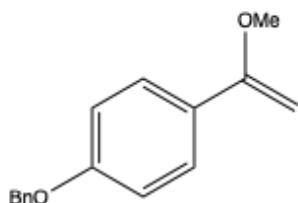

Yield: 2.17 g (90%), mp = 67 - 70 °C, R_f = 0.27 (30% MeOAc in petroleum ether). IR (ATR): 2936, 1511, 1333, 1170, 942, 740 cm^{-1} ; ^1H NMR (400 MHz, CDCl_3): δ 7.45 - 7.32 (m, 5H), 7.25 (d, J = 8.3 Hz, 2H), 7.01 (d, J = 8.3 Hz, 2H), 5.07 (s, 2H), 4.44 (d, J = 2.2 Hz, 1H), 4.20 (d, J = 2.2 Hz, 1H), 3.78 (s, 3H) ppm; ^{13}C NMR (100 MHz, CDCl_3): δ 159.2, 136.7, 128.7, 128.6, 128.3, 127.5, 115.1, 80.9, 70.0, 56.8 ppm; LRMS (ESI): Calcd for $\text{C}_{32}\text{H}_{32}\text{O}_4\text{Na}$ [$2\text{M} + \text{Na}^+$] 503.3, found 503.3.

1-(Benzyloxy)-3-(1-methoxyvinyl)benzene (55); Starting from 2-(3-(benzyloxy)phenyl)-2-methoxyethyl methanesulfonate (**47**) (3.36 g, 10.0 mmol) the vinyl ether **55** was prepared and isolated as white crystals using recrystallization from methylcyclohexane.

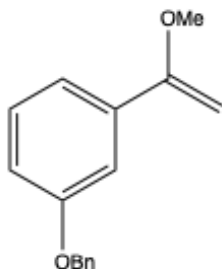

Yield: 2.08 g (87%), mp = 76 - 79 °C, R_f = 0.29 (30% MeOAc in petroleum ether). IR (ATR): 3057, 1514, 1324, 933, 742 cm^{-1} ; ^1H NMR (400 MHz, CDCl_3): δ 7.80 - 7.78 (m, 1H), 7.37 - 7.12 (m, 7H), 6.94-6.81 (m, 1H), 5.44 (d, J = 2.3 Hz, 1H), 5.01 (s, 2H), 4.97 (d, J = 2.3 Hz, 1H), 3.75 (s, 3H) ppm; ^{13}C NMR (100 MHz, CDCl_3): δ 158.9, 138.2, 136.5, 129.9, 128.6, 127.5, 127.4, 120.2, 114.8, 81.3, 70.1, 59.0 ppm; LRMS (ESI): Calcd for $\text{C}_{32}\text{H}_{32}\text{O}_4\text{Na}$ [$2\text{M} + \text{Na}^+$] 503.3, found 503.3.

1,2-(Dibenzyloxy)-4-(1-methoxyvinyl)benzene (56); Starting from 2-(3,4-(dibenzyloxy)phenyl)-2-methoxyethyl methanesulfonate (**45**) (4.43 g, 10.0 mmol) the vinyl ether **56** was prepared and isolated as yellow crystals using recrystallization from methylcyclohexane.

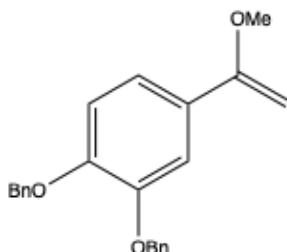

Yield: 2.71 g (78%), mp = 112 - 115 °C, R_f = 0.25 (30% MeOAc in petroleum ether). IR (ATR): 2899, 1507, 1354, 1267, 984, 736 cm^{-1} ; ^1H NMR (400 MHz, CDCl_3): δ 7.47 - 7.44 (m, 2H), 7.39 - 7.29 (m, 10H), 6.83 (d, J = 8.3 Hz, 1H), 5.18 (s, 2H), 5.17 (s, 2H), 4.38 (dd, J = 8.3, 3.7 Hz, 1H), 4.15 (dd, J = 11.2, 3.7 Hz, 1H), 3.73 (s, 3H) ppm; ^{13}C NMR (100 MHz, CDCl_3): δ 149.2, 137.0, 129.6, 128.5, 127.9, 127.5, 127.3, 114.9, 113.5, 81.1, 72.7, 71.2, 56.8 ppm; LRMS (ESI): Calcd for $\text{C}_{24}\text{H}_{23}\text{O}_5$ [$\text{M} + \text{CH}_2\text{O}_2 - \text{H}^-$] 391.1, found 391.1.

1-(1-Methoxyvinyl)-4-methylbenzene (57); Starting from 2-methoxy-2-(*p*-tolyl)ethyl methanesulfonate (**48**) (2.44 g, 10.0 mmol) the vinyl ether **57** was prepared and isolated as a yellow oil using DFC (PE/EtOAc, 95/5).

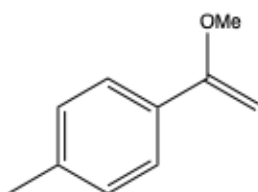

Yield: 1.40 g (94%), R_f = 0.73 (30% MeOAc in petroleum ether). IR (ATR): 2923, 1725, 1361, 1110, 909, 732 cm^{-1} ; ^1H NMR (400 MHz, CDCl_3): δ 7.39 - 7.35 (m, 2H), 7.22 - 7.11 (m, 2H), 4.63 (d, J = 2.7 Hz, 1H), 4.19 (d, J = 2.7 Hz, 1H), 3.74 (s, 3H), 2.34 (s, 3H) ppm; ^{13}C NMR (100 MHz, CDCl_3): δ 160.9, 138.0, 133.7, 128.5, 125.2, 81.3, 55.3, 21.1 ppm; LRMS (ESI): Calcd for $\text{C}_{10}\text{H}_{10}\text{ONa}$ [$\text{M} + \text{Na}^+ - 2\text{H}^-$] 169.1, found 169.1.

The spectroscopic data was in accordance with unpublished work of the Bakstad research group.^[22]

1-(*Tert*-butyl)-4-(1-methoxyvinyl)benzene (58); Starting from 2-(4-(*tert*-butyl)phenyl)-2-methoxyethyl methanesulfonate (**49**) (2.86 g, 10.0 mmol) the vinyl ether **58** was prepared and isolated as a yellow oil using DFC (PE/EtOAc, 95/5).

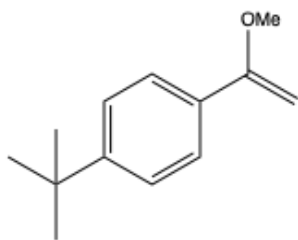

Yield: 1.56 g (82%), $R_f = 0.76$ (30% MeOAc in petroleum ether). IR (ATR): 2877, 1723, 1254, 1105, 748 cm^{-1} ; $^1\text{H NMR}$ (400 MHz, CDCl_3): δ 7.84 - 7.78 (m, 4H), 4.60 (d, $J = 2.5$ Hz, 1H), 4.15 (d, $J = 2.5$ Hz, 1H), 3.84 (s, 3H), 1.51 (s, 9H) ppm; $^{13}\text{C NMR}$ (100 MHz,

CDCl_3): δ 164.8, 155.7, 131.5, 126.6, 123.2, 81.6, 55.2, 34.5, 31.2 ppm; LRMS (ESI): Calcd for $\text{C}_{14}\text{H}_{19}\text{O}_3$ [$\text{M} + \text{CH}_2\text{O}_2 - \text{H}$] 235.1, found 235.1.

The spectroscopic data was in accordance with unpublished work of the Bakstad research group.^[22]

3.2.8 Synthesis of 2-alkoxy-1,1-dichlorocyclopropanes.

General procedure for the synthesis of cyclopropanes under phase transfer conditions.

Vinyl ether (0.30 mol), triethylbenzylammonium chloride (TEBA, catalytic amount, dichloromethane (DCM, 150 mL) and chloroform (107.43 g, 0.90 mol) was stirred vigorously using mechanical stirring and kept at 0 °C. A 50% aqueous solution of NaOH (24.00 g, 0.60 mol) was added dropwise to the mixture and continuously stirred at 0 °C for 30 min and concomitantly at room temperature (rt) for five hours. The reaction was quenched with H_2O (200 mL) and the aqueous phase was extracted with DCM (4 x 20 mL) and the combined organic layers were washed with H_2O (2 x 15 mL) and dried (Na_2SO_4). The product was isolated as a colourless liquid by fractional distillation. By employing this procedure, the following cyclopropanes were obtained.

1,1-Dichloro-2-ethoxycyclopropane (59); Starting from ethyl vinyl ether (**60**) (21.76 g, 0.30 mol) the cyclopropane **59** was prepared.

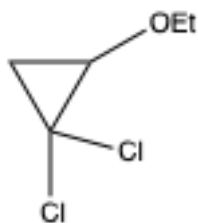

Yield: 40.46 g (87%), bp = 50 - 52 °C/20 torr (Lit. 53 - 54 °C/28 torr)^[40]. IR (ATR): 2935, 1400, 1173, 1117, 1024 cm^{-1} ; $^1\text{H NMR}$ (400 MHz, CDCl_3): δ 3.80 - 3.72 (m, 2H), 3.52 (q, $J = 5.1$ Hz, 1H), 1.66 - 1.62 (m, 1H), 1.57 - 1.50 (m, 1H), 1.27 (t, $J = 7.1$ Hz, 3H) ppm; $^{13}\text{C NMR}$ (100 MHz, CDCl_3): δ 67.2, 63.1, 58.6, 27.9, 14.9 ppm.

The spectroscopic data was in accordance with literature.^[117 - 118]

1,1-Dichloro-2-(dimethoxymethyl)-2-methoxycyclopropane (61); Starting from 2,3,3-trimethoxyprop-1-ene (**50**) (39.46 g, 0.30 mol) the cyclopropane **61** was prepared.



Yield: 40.08 g (62%). bp = 86 - 88 °C/20 torr, IR (ATR): 2980, 1233, 1062, 765 cm^{-1} ; $^1\text{H NMR}$ (400 MHz, CDCl_3): δ 5.74 (s, 1H), 3.45 (s, 3H), 3.39 (s, 6H), 1.09 (s, 1H), 1.04 (s, 1H) ppm; $^{13}\text{C NMR}$ (100 MHz, CDCl_3): δ 101.4, 66.4, 62.2, 57.0, 54.5, 16.1 ppm; LRMS (ESI): Calcd for $\text{C}_9\text{H}_{15}\text{O}_3\text{Cl}_2\text{N}$ [$\text{M} + \text{CH}_3\text{CN} + \text{H}^+$] 258.2, found 258.2.

The spectroscopic data was in accordance with unpublished work of the Bakstad research group.^[79]

3.2.9 Ring opening of 2-alkoxy-1,1-dichlorocyclopropanes.

General procedure for the synthesis of alkynes from cyclopropanes.

Sodium oxide (0.20 mol) was added dropwise to a mixture of cyclopropane (50.0 mmol) and dimethylformamide (DMF, 150 mL). The solution was stirred at 0 °C for 2 hours and concomitantly at rt for five hours. The reaction was quenched with H₂O (100 mL), the aqueous phase was extracted using Et₂O (4 x 20 mL) and the combined organic phases were washed with H₂O (2 x 15 mL) and dried (Na₂SO₄). The organic layers were concentrated under reduced pressure and the product was isolated as a colourless liquid by fractional distillation. By employing this procedure, the following alkynes were synthesized.

3,3-Diethoxyprop-1-yne (62); Starting from 1,1-dichloro-2-ethoxycyclopropane (**59**) (7.75 g, 50.0 mmol) and sodium ethoxide (13.60 g, 0.20 mol) the alkyne **62** was prepared.

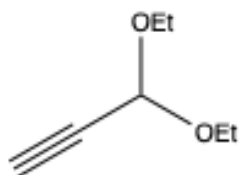

Yield: 4.42 g (69%), bp = 47 - 50 °C/20 torr (Lit. 45 - 47 °C/18 torr)^[119], *R_f* = 0.66 (5% MeOAc in petroleum ether). IR (ATR): 2930, 1927, 1484, 1110, 890 cm⁻¹; ¹H NMR (400 MHz, CDCl₃): δ 5.24 (s, 1H), 3.64 - 3.46 (m, 4H), 2.73 (s, 1H), 1.28 (t, *J* = 7.0 Hz, 6H) ppm; ¹³C NMR (100 MHz, CDCl₃): δ 90.9, 79.0, 73.5, 61.0,

14.9 ppm.

The spectroscopic data was in accordance with literature.^[59, 120]

3,3,4,4-tetramethoxybut-1-yne (63); Starting from 1,1-dichloro-2-(dimethoxymethyl)-2-methoxycyclopropane (**61**) (10.10 g, 50.0 mmol) and sodium methoxide (10.80 g, 0.20 mol) the alkyne **63** was prepared.

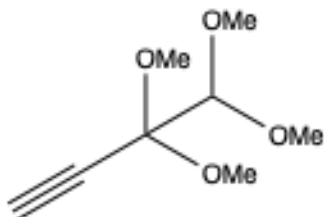

Yield: 5.92 g (68%), bp = 55 - 60 °C/20 torr, IR (ATR): 2943, 1676, 1086, 960 cm⁻¹; ¹H NMR (400 MHz, CDCl₃): δ 5.15 (s, 1H), 3.49 (s, 6H), 3.38 (s, 6H), 2.62 (s, 1H) ppm; ¹³C NMR (100 MHz, CDCl₃): δ 105.5, 98.8, 75.8, 56.9, 51.4, 15.1 ppm; LRMS (ESI): Calcd for C₈H₁₁O₃ [*M* - H₂O - H]⁺ 155.0, found 155.0.

The spectroscopic data was in accordance with previous unpublished work of the Bakstad research group.^[79]

4. References

- [1] C. P. Casey, *J. Chem. Ed.* **2006**, *83*, 192.
- [2] H. Meerwein, in *Methoden der Organischen Chemie, Houb en Weyl, Vol. 6/3*, **1965**, pp. 90 - 116.
- [3] R. Huisgen, R. Schug, *J. Am. Chem. Soc.* **1976**, *98*, 7819 - 7821.
- [4] S. J. Rhoads, R. N. Raulins, *Organic Reactions* **1975**, *22*, 1.
- [5] W. Oppolzer, R. L. Snowden, *Tetrahedron Lett.* **1976**, *17*, 4187 - 4190.
- [6] M. Schlosser, *Angew. Chem. Internat. Edn.* **1974**, *13*, 701 - 706.
- [7] J. Hartmann, R. Muthukrishnan, M. Schlosser, *Helv. Chim. Acta* **1974**, *57*, 2261 - 2275.
- [8] G. M. Rubottom, M. A. Vazquez, D. R. Pelegrina, *Tetrahedron Lett.* **1974**, *15*, 4319 - 4322.
- [9] G. M. Rubottom, J. M. Gruber, R. K. Boeckman, M. Ramaiah, J. B. Medwid, *Tetrahedron Lett.* **1978**, *19*, 4603 - 4606.
- [10] S. Danishefsky, T. Kitahara, *J. Am. Chem. Soc.* **1974**, *96*, 7807 - 7808.
- [11] H. Schlude, *Tetrahedron* **1975**, *31*, 89 - 92.
- [12] C. Earnshaw, C. J. Wallis, S. Warren, *J. Chem. Soc., Perkin Trans. 1* **1979**, 3099 - 3106.
- [13] I. P. Andrews, O. Kwon, *Tetrahedron Lett.* **2008**, *49*, 7097 - 7099.
- [14] T. Okano, T. Michihashi, J. Kiji, *Appl. Organometal. Chem.* **1995**, *9*, 473 - 478.
- [15] P. G. Gassman, S. J. Burns, *J. Org. Chem.* **1988**, *53*, 5574 - 5576.
- [16] M. F. Shostakovsky, N. A. Gershtein, Z. S. Volkova, *Russ. Chem. Bull.* **1953**, *2*, 89 - 95.
- [17] T. Higashimura, M. Sawamoto, in *Comprehensive Polymer Science and Supplements* (Eds.: G. Allen, J. C. Bevington), Pergamon, Amsterdam, **1989**, pp. 673 - 696.
- [18] G. Shroder, in *Ullmann's Encyclopedia of Industrial Chemistry, Vol. 28*, **2000**, pp. 481 - 485.
- [19] C. E. Schildknecht, A. O. Zoss, C. McKinley, *Ind. Eng. Chem.* **1947**, *39*, 180 - 186.
- [20] S. Winstein, L. L. Ingraham, *J. Am. Chem. Soc.* **1955**, *77*, 1738 - 1743.
- [21] M. K. Agrawal, S. Adimurthy, B. Ganguly, P. K. Ghosh, *Tetrahedron* **2009**, *65*, 2791 - 2797.
- [22] D. Maharjan, *MSc of Science, UiS*, **2018**.
- [23] Y. Luijckx, *MSc of Science, Radbound Universiteit Nijmegen* **2015**.
- [24] L. David, A. Gazel, A. Kergomard, *Bull. Soc. Chim. Fr.* **1978**, *11*, 587 - 589.
- [25] E. J. Corey, M. Chaykovsky, *J. Am. Chem. Soc.* **1965**, *87*, 1353 - 1364.
- [26] N. Prileschajew, *Ber. Dtsch. Chem. Ges.* **1909**, *42*, 4811 - 4815.
- [27] K. Tanaka, K.-i. Otani, T. Murase, S. Nishihote, Z. Urbanczyk-Lipkowska, *Bull. Chem. Soc. Jpn.* **2012**, *85*, 709 - 714.
- [28] R. S. Tipson, *J. Org. Chem.* **1944**, *09*, 235 - 241.
- [29] Y. Kosaki, N. Ogawa, Q. Wang, Y. Kobayashi, *Org. Lett.* **2011**, *13*, 4232 - 4235.
- [30] R. Ding, Y. He, X. Wang, J. Xu, Y. Chen, M. Feng, C. Qi, *Molecules* **2011**, *16*, 5665 - 5673.
- [31] L. K. Sydnes, E. Bakstad, *Advances in Strain in Organic Chemistry*, London, Jai Press Inc., **1996**, *5*, pp 85 - 119.
- [32] L. K. Sydnes, L. Skattebøl, C. B. Chapleo, D. G. Leppard, K. L. Svanholt, A. S. Dreiding, *Helv. Chim. Acta* **1975**, *58*, 2061 - 2073.
- [33] L. Skattebøl, *Tetrahedron Lett.* **1961**, *2*, 167 - 172.

- [34] L. K. Sydnes, L. Skattebøl, *Acta Chem. Scand.* **1978**, 32, 632 - 638.
- [35] T. C. Shields, B. A. Shoulders, J. F. Krause, C. L. Osborn, P. D. Gardner, *J. Am. Chem. Soc.* **1965**, 87, 3026 - 3027.
- [36] T. C. Shields, P. D. Gardner, *J. Am. Chem. Soc.* **1967**, 89, 5425 - 5428.
- [37] T. C. Shields, W. E. Billups, A. R. Lepley, *J. Am. Chem. Soc.* **1968**, 90, 4749 - 4751.
- [38] W. E. Billups, W. Y. Chow, J. H. Cross, *J. Am. Chem. Soc.* **1974**, 252 - 252.
- [39] P. Müller, H.-C. Nguyen-Thi, *Helv. Chim. Acta* **1984**, 67, 467 - 470.
- [40] W. von E. Doering, W. A. Henderson, *J. Am. Chem. Soc.* **1958**, 80, 5274 - 5277.
- [41] W. von E. Doering, A. K. Hoffmann, *J. Am. Chem. Soc.* **1954**, 76, 6162 - 6165.
- [42] E. J. Corey, P. Ulrich, *Tetrahedron Lett.* **1975**, 16, 3685 - 3688.
- [43] B. T. Gillis, K. F. Schimmel, *J. Org. Chem.* **1962**, 27, 1071 - 1072.
- [44] D. Hamon, V. Trenerry, *Aust. J. Chem.* **1980**, 33, 809 - 821.
- [45] M. Mąkosza, M. Wawrzyniewicz, *Tetrahedron Lett.* **1969**, 10, 4659 - 4662.
- [46] K. Shanmugam, E. Kannadasan, *Int. J. Curr. Microbiol. App. Sci.* **2014**, 3, 211 - 223.
- [47] W. Kirmse, Academic Press, New York, **1971**, pp. 256 - 267.
- [48] M. N. Hopkinson, C. Richter, M. Schedler, F. Glorius, *Nature* **2014**, 510, 485 - 496.
- [49] C. Y. Chan, A. Noor, C. A. Mclean, P. S. Donnelly, P. J. Barnard, *J. Am. Chem. Soc.* **2017**, 2311 - 2314.
- [50] S. K. Fung, T. Zou, B. Cao, T. Chen, W.-P. To, C. Yang, C.-N. Lok, C.-M. Che, *J. Am. Chem. Soc.* **2016**, 7, 9.
- [51] J. L. Hickey, R. A. Ruhayel, P. J. Barnard, M. V. Baker, S. J. Berners-Price, A. Filipovska, *J. Am. Chem. Soc.* **2008**, 130, 12570 - 12571.
- [52] K. M. Hindi, M. J. Panzner, C. A. Tessier, C. L. Cannon, W. J. Youngs, *Chem. Rev.* **2009**, 109, 3859 - 3884.
- [53] A. H. Sandtorv, C. Leitch, S. L. Bedringaas, B. T. Gjertsen, H.-R. Bjørsvik, *ChemMedChem* **2015**, 1522 - 1527.
- [54] S. Kankala, R. K. Kankala, R. Balaboina, N. S. Thirukovela, R. Vadde, C. S. Vasam, *Bioorg. Med. Chem. Lett.* **2013**, 24, 1180 - 1183.
- [55] M. Pellei, V. Gandin, M. Marinelli, C. Marzano, M. Yousufuddin, H. V. R. Dias, C. Santini, *Inorg. Chem.* **2012**, 9873 - 9882.
- [56] E. Schuh, C. Pfluger, A. Citta, A. Folda, M. P. Rigobello, A. Bindoli, A. Casini, F. Mohr, *J. Med. Chem.* **2012**, 5518 - 5528.
- [57] Y. Zhang, S. Zhang, Z. Tian, J. Li, Z. Xu, S. Li, Z. Liu, *Roy. Soc. Chem. Dalton Trans.* **2018**, 13781 - 13787.
- [58] A. Mottais, M. Berchel, Y. Sibiril, V. Laurent, D. Gill, S. Hyde, P.-A. Jaffres, T. Montier, T. L. Gall, *J. Cyst. Fibros.* **2018**, 536, 29 - 41.
- [59] L. K. Sydnes, E. Bakstad, *Acta Chem. Scand.* **1996**, 50, 446 - 453.
- [60] H. Molitor, *J. Pharmacol. Exp. Ther.* **1936**, 57, 274 - 288.
- [61] R. Walter, K. Ernst, *Preparation of compounds having hydroxy or O-metal groups bound to a carbon atom not belonging to a six-membered aromatic ring, DE289800* **1943**.
- [62] G. Walter, E. Hans, *Verfahren zur Herstellung von Allophanaten von - AEthynylcarbinolen, DE959458* **1957**.
- [63] L. Wei, F. Hu, Y. Shen, Z. Chen, Y. Yu, C.-C. Lin, M. C. Wang, W. Min, *Nat. Methods* **2014**, 11, 410 - 412.
- [64] A. L. K. Shi Shun, R. R. Tykwinski, *Angew. Chem. Int. Ed.* **2006**, 45, 1034 - 1057.
- [65] M. F. Shostakovskii, B. A. Trofimov, A. S. Atavin, V. I. Lavrov, *Russ. Chem. Rev.* **1968**, 37, 907 - 919.
- [66] D. Winterheimer, R. E. Shade, C. A. Merlic, *Synth.* **2010**, 15, 2497 - 2511.
- [67] T. Sorrell, *Organic Chemistry, Vol. 2*, **1999**.

- [68] M. Blümel, S. Nagasawa, K. Blackford, S. R. Hare, D. J. Tantillo, R. Sarpong, *J. Am. Chem. Soc.* **2018**, *140*, 9291 - 9298.
- [69] H. Kunz, M. Lindig, *Chemische Berichte* **1983**, *116*, 220 - 229.
- [70] L. G. Wade, J. W. Simek, *Organic Chemistry, Vol. 9*, **1991**.
- [71] P. A. Sagstad, *BSc of Science, UiS*, **2018**.
- [72] D. I. Metelitsa, *Russ. Chem. Rev.* **1972**, *41*, 807 - 821.
- [73] C. E. Paul, D. Tischler, A. Riedel, T. Heine, N. Itoh, F. Hollmann, *ACS Catal.* **2015**, *5*, 2961 - 2965.
- [74] M. Ali Nasser, A. Allahresani, H. Raissi, *React. Kinet. Mech. Catal.* **2014**, *112*, 387 - 408.
- [75] G.-Q. Chen, Z.-J. Xu, C.-Y. Zhou, C.-M. Che, *J. Am. Chem. Soc.* **2011**, *47*, 10963 - 10965.
- [76] R. E. Parker, N. S. Isaacs, *Chem. Rev.* **1959**, *59*, 737 - 799.
- [77] X.-L. Liu, S.-R. Sheng, Q.-Y. Wang, W.-K. Sun, Q. Xin, H.-Y. Ao, *J. Chem. Res.* **2006**, *2*, 118 - 120.
- [78] J. B. Jones, M. Dickman, *Chemically modified mutant serine hydrolases show improved catalytic activity and chiral selectivity. WO 2000028007* **1999**.
- [79] E. Bakstad, *Unpublished results*.
- [80] L. K. Sydnes, E. Bakstad, *Acta Chem. Scand.* **1997**, *51*, 1132 - 1133.
- [81] L. Skattebøl, *J. Org. Chem.* **1966**, *31*, 1554 - 1559.
- [82] W. Bradley, R. Robinson, *J. Chem. Soc.* **1928**, 1541 - 1569.
- [83] S. Kim Yong, H. Chang, F. Kadla John, in *Holzforschung, Vol. 62*, **2008**, p. 38.
- [84] J. Cvengroš, S. Neufeind, A. Becker, H.-G. Schmalz, *Synlett* **2008**, *13*, 1993 - 1998.
- [85] E. Bakstad, *Method for the synthesis of anthocyanins, US 8,513,395 B2* **2013**.
- [86] N. A. Keiko, Y. A. Chuvashov, L. G. Stepanova, M. G. Voronkov, *Russ. Chem. Bull.* **1998**, *47*, 2422 - 2425.
- [87] Y. Hayashi, Y. Sasaki, *J. Am. Chem. Soc.* **2005**, 2716 - 2718.
- [88] R. Taylor, *J. Chem. Soc. Perkin Trans. 2* **1988**, 737-743.
- [89] Y. Shusterman-Honger, J. Y. Becker, *J. Electroanal. Chem.* **2015**, *740*, 105 - 113.
- [90] N. Sakai, K. Moritaka, T. Konakahara, *Eur. J. Org. Chem.* **2009**, *24*, 4123 - 4127.
- [91] T. Kishimoto, Y. Uraki, M. Ubukata, *J. Wood Chem. Tech.* **2008**, *28*, 97 - 105.
- [92] E. Fuglseth, T. Anthonsen, B. Hoff, *Tetrahedron Asymm.* **2006**, *17*, 1290 - 1295.
- [93] S. Kobayashi, K. Okimoto, Y. Imakura, *Chem. Pharm. Bull.* **1982**, *30*, 1567 - 1573.
- [94] M. Carmen Cruz, J. Tamariz, *Tetrahedron* **2005**, *61*, 10061 - 10072.
- [95] H. S. Mahal, H. S. Rai, K. Venkataraman, *J. Chem. Soc.* **1935**, 866 - 868.
- [96] A. Gissot, A. Wagner, C. Mioskowski, *Tetrahedron* **2004**, *60*, 6807 - 6812.
- [97] M. Metzler, *J. Label. Compd. Radiopharm.* **1978**, *15*, 127 - 139.
- [98] B. Das, K. Suneel, G. Satyalakshmi, D. N. Kumar, *Tetrahedron Asymm.* **2009**, *20*, 1536 - 1540.
- [99] C.-F. Lin, J.-S. Yang, C.-Y. Chang, S.-C. Kuo, M.-R. Lee, L.-J. Huang, *Bioorg. Med. Chem.* **2005**, *13*, 1537 - 1544.
- [100] Z. Wang, C. Wang, W. Bao, T. Ying, *J. Chem. Res.* **2005**, *6*, 388 - 390.
- [101] N. R. Easton, F. A. L. Anet, P. A. Burns, C. S. Foote, *J. Am. Chem. Soc.* **1974**, *96*, 3945 - 3948.
- [102] P. C. B. Page, B. R. Buckley, L. F. Appleby, P. A. Alsters, *Synth.* **2005**, *19*, 3405 - 3411.
- [103] J. Goswami, R. L. Bezbaruah, A. Goswami, N. Borthakur, *Tetrahedron Asymm.* **2002**, *12*, 3343 - 3348.
- [104] W.-X. Hu, P.-R. Li, G. Jiang, C.-M. Che, J. Chen, *Adv. Synth. Catal.* **2010**, *352*, 3190 - 3194.

- [105] D. C. Horwell, S. Osborne, *Peripherally selective kappa opioid agonists, US 6057357* **2000**.
- [106] S. P. Baker, A. Liptak, J. Pitha, *J. Bio. Chem.* **1985**, *260*, 15820 - 15828.
- [107] H. P. Märki, Y. Cramer, R. Eigenmann, A. Krasso, H. Ramuz, K. Bernauer, M. Goodman, K. L. Melmon, *Helv. Chim. Acta* **1988**, *71*, 320 - 336.
- [108] M. K. Tse, M. Klawonn, S. Bhor, C. Döbler, G. Anilkumar, H. Hugl, W. Mägerlein, M. Beller, *Org. Lett.* **2005**, *7*, 987 - 990.
- [109] M. R. Monaco, D. Fazzi, N. Tsuji, M. Leutzsch, S. Liao, W. Thiel, B. List, *J. Am. Chem. Soc.* **2016**, *138*, 14740 - 14749.
- [110] S. Noboru, T. Shigeru, *Bull. Chem. Soc. Jpn* **1965**, *38*, 958 - 961.
- [111] B. H. Kim, F. Piao, E. J. Lee, J. S. Kim, Y. M. Jun, B. M. Lee, *Bull. Kor. Chem. Soc.* **2004**, *25*, 881 - 888.
- [112] H. Hara, R. Shirai, O. Hoshino, B. Umezawa, *Chem. Pharm. Bull.* **1985**, *33*, 3107 - 3112.
- [113] A. A. Tehrani, S. Abedi, A. Morsali, J. Wang, P. C. Junk, *J. Mater. Chem. A* **2015**, *3*, 20408 - 20415.
- [114] P. C. Bulman Page, Y. Chan, H. Heaney, M. J. McGrath, E. Moreno, *Eur. J. Org. Chem.* **2011**, *2011*, 5347 - 5354.
- [115] E. Taskinen, *Acta Chem. Scand.* **1985**, *39B*, 877 - 878.
- [116] A. R. Katritzky, S. I. Bayyuk, S. Rachwal, *Synth.* **1991**, *4*, 279 - 283.
- [117] S. M. Shostakovskii, V. N. Mochalov, G. M. Larionov, *Pharma. Chem. J.* **1985**, *19*, 770 - 775.
- [118] O. H. Kvernenes, L. K. Sydnes, *Org. Synth.* **2006**, 184 - 192.
- [119] S. M. McElvain, L. R. Morris, *J. Am. Chem. Soc.* **1952**, *74*, 2657 - 2662.
- [120] B. J. Albert, K. Koide, *J. Org. Chem.* **2008**, *73*, 1093 - 1098.

5. Appendix

5.1 Structures

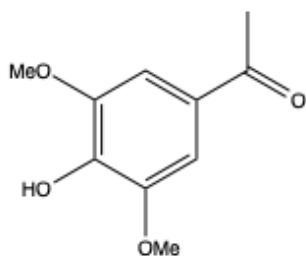
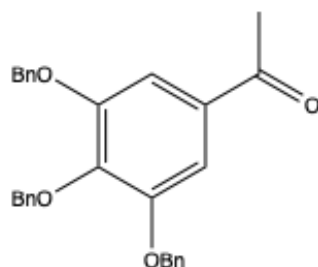
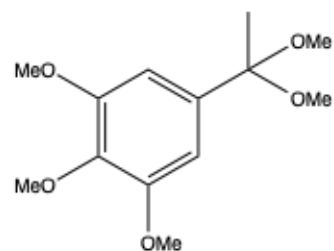
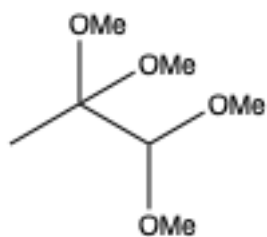
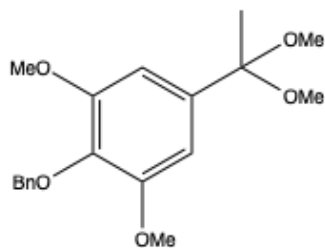
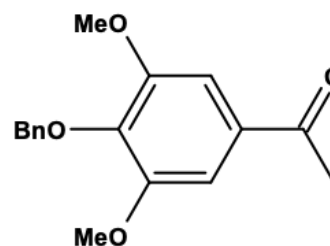
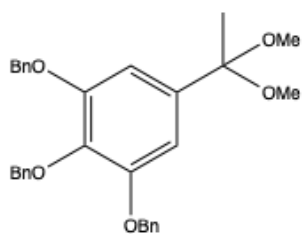
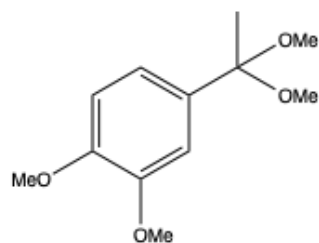
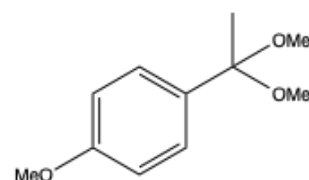
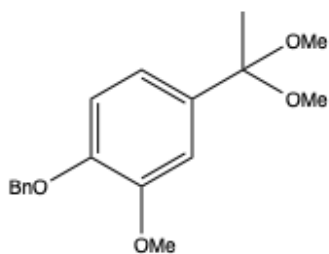
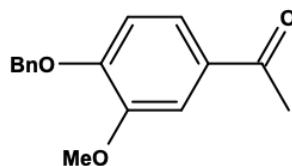
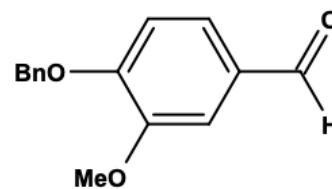
1.**3.****5.****6.****8.****9.****10.****11.****13.****15.****16.****18.**

20.

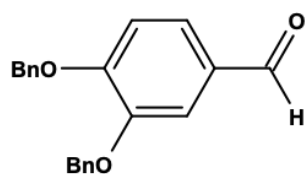

22.

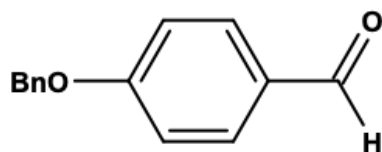

24.

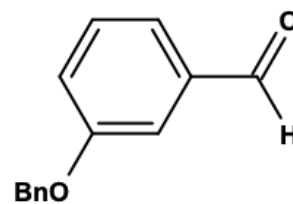

26.

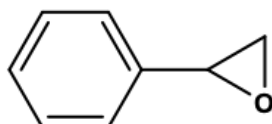

28.

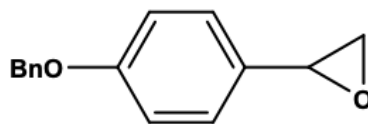

29.

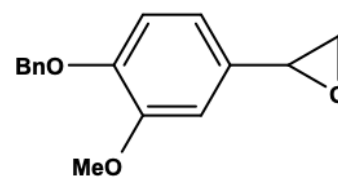

30.

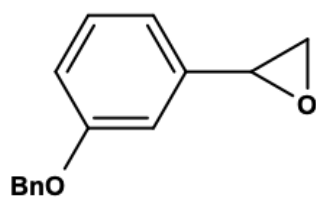

31.

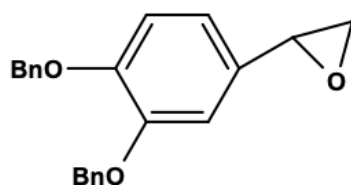

32.

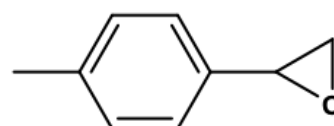

34.

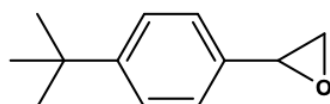

36.

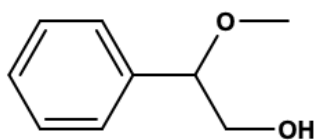

37.

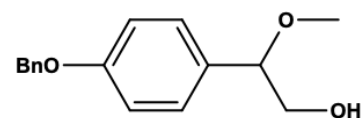

38.

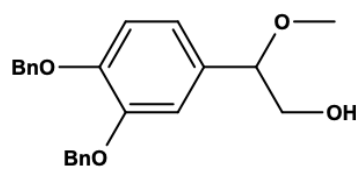

39.

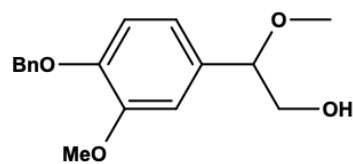

40.

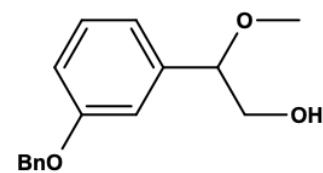

41.

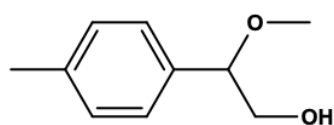

42.

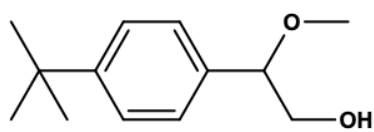

43.

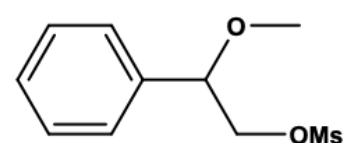

44.

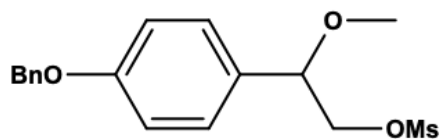

45.

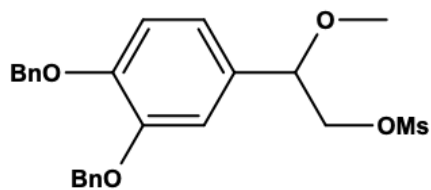

46.

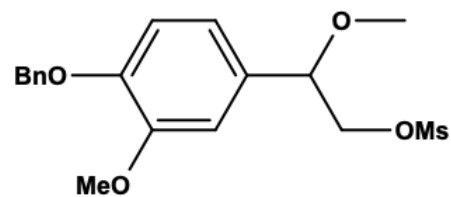

47.

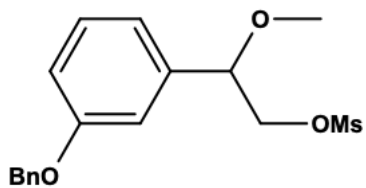

48.

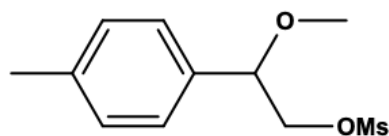

49.

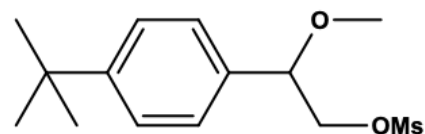

50.

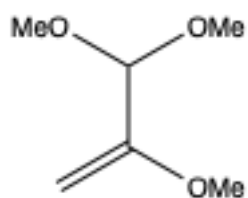

51.

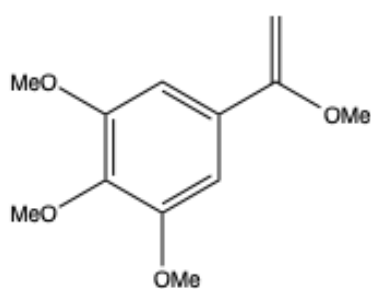

52.

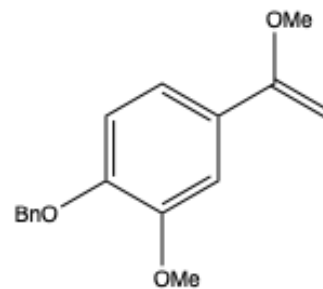

53.

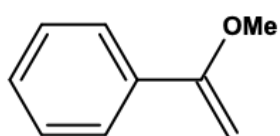

54.

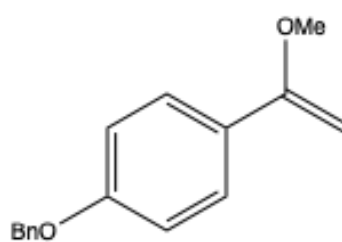

55.

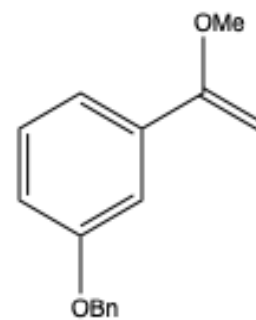

56.

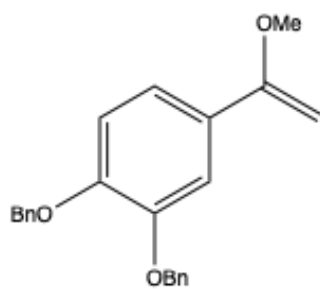

57.

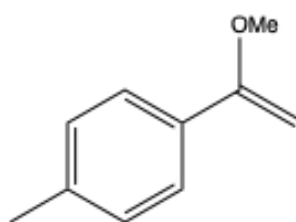

58.

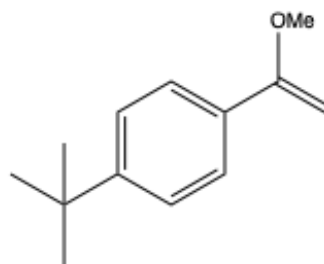

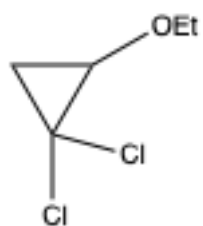
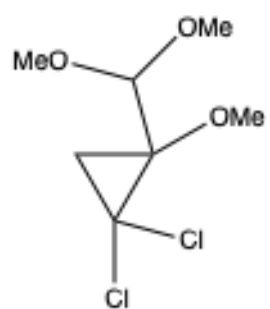
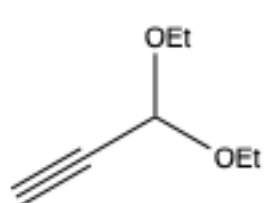
59.**61.****62.****63.**