



FACULTY OF SCIENCE AND TECHNOLOGY

BACHELOR THESIS

Study programme / specialisation:

Petroleumsteknologi

The spring semester, 2022

Author: **Gunnar Sørseth Fuglestad**

Open

Course coordinator:

Supervisor(s): **Kjell Kåre Fjelde**

.....
(signature author)

Thesis title: **Reliability based casing design**

Credits (ECTS): 20

Keywords:

Reliability based casing design

Burst

Working stress design

Monte Carlo Simulations

Casing design

Pages: 33

+ appendix:11

Stavanger, may 15th/2022
date/year

Acknowledgment

I would like to thank my supervisor: Kjell Kåre Fjelde for all the incredible support and feedback he has provided.

The recommended material he provided was significantly helpful, and the follow-up was excellent.

I would also like to thank my family and friends for the patience.

Abstract

Working stress design is today the most used method for casing design. This method is easy to learn and uses enough safety factors to provide a safe design. Reliability based design is a stochastic approach to casing design that adds another layer of complexity. The reliability based design method applies safety factors for specific parameters from the case study. This helps us visualize the different safety factors and where the safety factors are applied rather than taking the safety factors for granted. The reliability based design method calculates a probability of failure that determines whether the selected casing meets the recommended requirements for a specific scenario. The probability of failure allows us to utilize risk assessment of the selected casing and puts a number on how safe the design actually is.

The case study tested both WSD and RBD for a burst scenario and evaluated which casing grade met the requirements for the different methods and models. First, the WSD methodology was tested for a casing grade of CP110, and the result showed that the selected casing grade did not satisfy the requirements for WSD after applying the NORSOK safety factor. The same parameters were then tested for different burst strength models in RBD. The Barlow model resulted in meeting the requirements for a casing grade of CP110 for high consequence failures. The ad-hoc model resulted in meeting the requirements for an even lower casing grade of RT95 for high consequence failures.

RBD level 4 was tested using Monte Carlo simulations in MATLAB. The number of iterations required for the simulations was determined based on calculation time, variability, and stabilization of the different output parameters. The testing concluded that 10^8 iterations were reasonable for high consequence failures such as burst.

The conclusion is that RBD4 is well suited for burst scenarios. The RBD method allowed us to choose a lower grade for the selected casing than WSD and provided output parameters that are useful for risk assessments.

Table of Contents

- Acknowledgment..... 1
- Abstract 2
- List of figures 4
- List of tables 5
- List of equations 5
- Abbreviations 6
- Symbols 6
- 1 Introduction..... 7
 - Background..... 7
 - Problem definition and objective 7
 - Structure..... 7
- 2 Casing design 8
 - Conductor casing:..... 9
 - Surface casing:..... 9
 - Intermediate casing:..... 9
 - Production casing: 9
 - Production liner:..... 10
 - Casing setting depth:..... 10
 - Loads..... 12
 - Burst: 12
 - Survival and service loads..... 14
- 3 Design methods..... 14
 - Working stress design 14
 - Reliability based design 16
- 4 Case study..... 18
 - Strength models for burst 19
 - API model 19
 - Probabilistic API model..... 19
 - Probabilistic Barlow model..... 20
 - Probabilistic ad-hoc model..... 20
 - Acceptance Criteria 21
 - Working stress design 25

Reliability based design	26
Probabilistic API model.....	27
Probabilistic Barlow model.....	29
Probabilistic ad-hoc model.....	32
Simulation results.....	34
5 Discussion and conclusion	36
6 Recommendations.....	38
References.....	38
Appendix.....	39
A.1 Monte Carlo Simulation MATLAB codes	39
A.1.1 Probabilistic APE Model	39
A.1.2 Probabilistic Barlow Model	41
A.1.3 Probabilistic ad-hoc Model	43

List of figures

Figure 1 Casing design example	8
Figure 2 Stress-strain curve.....	12
Figure 3 Stresses and failure of thin-walled vessel pressured from the inside [1].....	13
Figure 4 Traditional WSD approach	15
Figure 5 Flow chart, RBD4 for survival loads.....	17

Figure 6 Pressure gradient plot.....	18
Figure 7 Probabilistic API RBD4, CP110.....	28
Figure 8 Results from Probabilistic Barlow simulation	Error! Bookmark not defined.
Figure 9 Probabilistic Barlow RBD4, CP110.....	30
Figure 10 Probabilistic Barlow RBD4, RT95	32
Figure 11 Probabilistic ad-hoc RBD4, RT95	34

List of tables

Table 1 Mud weight, casing size and setting depth for case study.....	18
Table 2 Distribution parameters for the simulations [5]	20
Table 3 Monte Carlo simulation data for the probability of failure with various number of iterations	22
Table 4 Monte Carlo simulation data for spread with various number of iterations.....	22
Table 5 Monte Carlo simulation data for mean-value with various number of iterations.....	23
Table 6 Monte Carlo simulation data for the probability of failure with various number of iterations	24
Table 7 Parameters for Probabilistic API simulation.....	27
Table 8 Results from Probabilistic API simulation.....	28
Table 9 Parameters for Probabilistic Barlow simulation.....	29
Table 10 Parameters for Probabilistic Barlow simulation.....	31
Table 11 Results from Probabilistic Barlow simulation.....	31
Table 12 Parameters for Probabilistic as-hoc simulation.....	32
Table 13 Results from Probabilistic ad-hoc simulation	33
Table 14 Results summarized from all the simulations.....	34

List of equations

Abbreviations

RBD – Reliability based design

WSD – Working stress design

LSD – Limit state design

BOP – Blow out preventer

ISO – International Organization for Standardization

DDH – Drilling Data Handbook

API – American Petroleum Institute

BHP – Bottom hole pressure

RBD4 – Reliability based design level 4

Symbols

P_i – Inner pressure

ρ_{sw} – Seawater pressure

P_o – Outer pressure

t – Thickness

$P_{external}$ – External pressure

$\sigma_{ultimate}$ – Ultimate yield strength

$P_{internal}$ – Internal pressure

P_{burst} – Burst pressure

σ_{yield} – Nominal yield strength

d_0 – Outer diameter

ρ_{pore} – Pore pressure

g – Gravity constant

1 Introduction

Background

The petroleum industry is in constant development. New methods are constantly developed to increase safety and decrease the cost of operations. Reliability based design is a stochastic method of predicting output parameters such as the probability of failure. These parameters can be used to determine what casing grade is required for a specific. In some cases, the reliability based approach can result in a lower casing grade than traditional working stress design methods. This can significantly decrease the cost of a well. The output parameters from RBD can also help us further determine the risks associated with the well with output parameters such as mean strength, spread, and probability of failure.

Problem definition and objective

The goal of this thesis is to evaluate how level 4 reliability based design can be applied to burst scenarios. The thesis will also focus on different strength models in RBD as well as the working stress design method, and compare the different results.

The thesis will initially focus on a casing grade of CP110 for an intermediate casing section. Burst calculations will then be performed first by using the classic WSD method, before moving on to RBD and different strength models. The most conservative models will be used first before we test with models that remove safety factors and replace nominal yield values with ultimate yield values.

Structure

The thesis is divided into five chapters.

The first chapter covers the introduction of the thesis and comprises the background, problem definition, objective, and structure.

The second chapter covers the basics of casing design.

The third chapter explain the different design methods such as RBD and WSD.

The fourth chapter is the case study. RBD4 and WSD will be tested for a burst scenario.

The fifth chapter will include the conclusion and discussion of the results.

Recommendations for future work is provided after the discussion.

The Appendix shows the different MATLAB codes that were used in the case study.

2 Casing design

Casing design is a major and very important activity in the design and planning of a well. The casing is a large structural component designed to withstand all expected loads and stresses during the entire lifetime of the well. Designing a well involves determining the tubular weight, tubular size, grade, connectors, and setting depth. Casing costs are one of the most expensive cost items of the drilling project. Thus, proper design is vital in keeping the well cost-effective and safe [7].

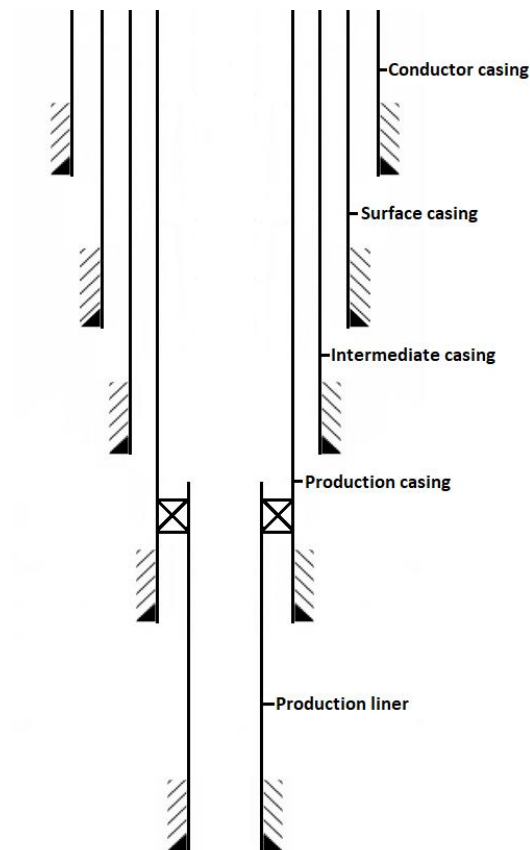

Figure 1 Casing design example

Conductor casing:

The conductor casing is the first casing and therefore the largest in diameter, as the casings progressively decrease in diameter so that the next casing can pass through the previous ones. The conductor functions as a support for the wellhead and isolates the well from unconsolidated formations. On floating rigs, the conductor will function as a support for the template and marine raisers. Similarly, it will support the mudline suspension system on jack-up rigs [1].

Surface casing:

The surface casing is the second casing to be placed, and similarly to the conductor, its main function is to isolate against weak formations. This casing is designed to carry the weight of both the wellhead and blowout preventer (BOP) [1].

Intermediate casing:

The function of the intermediate casing is to isolate every formation up to the surface casing. This ensures that the next section can be drilled effectively and safely. Formations can in these depths be abnormally pressurized, weak, or unstable. Depending on the depth and formation encountered more casing strings might be required. It is thus important to ensure the inner diameter of the pay zone is big enough for production when more than one string is used [1]. Designing the well from the inner casing and outwards thus becomes apparent, ensuring all requirements are met step by step in the design process.

Production casing:

To isolate the productive zones, the production casing is placed. The casing will ensure that the annulus across the productive zones is properly cemented, to prevent fluid from migrating through the wellbore. Through the lifetime of the well, this casing is designed to withstand formation pressures, chemical wear, and mechanical wear. In addition, it should also withstand possible gas lifts and will be the primary barrier to any unexpected pressures from the reservoir. The production casing will thus be designed with full well integrity, meaning it should be able to withstand full reservoir pressure [1].

Production liner:

Unlike the Production casing, the Production liner does not extend to the top and is instead hung from the production casing. The liner does however extend into the reservoir, and thus needs to be designed for full well integrity if possible. The production liner is used if there is no production casing or if the production casing doesn't extend down into the reservoir. Thus, it should fulfill the same casing requirements of the production casing [1].

Casing setting depth:

The main objective when choosing a setting depth for the casing is to ensure the next open hole section is drilled successfully and safely. The setting depth of a casing is determined based on pore, fracture, and collapse pressure, as well as the lithology of the wellbore. During both drilling and production, one must stay between the pressure margins to mitigate the risk of unwanted situations. The easiest way to stay between these margins is to adjust the mudweight. If a too high mudweight is chosen, we might experience fracturing of the formation. Conversely, if the mudweight is insufficient formation fluids could start entering the wellbore. Once the inside pressure is too low it will no longer be able to hold up the formation, which could cause the wellbore to collapse. The lithology of the wellbore should also be evaluated to avoid unstable formations such as broken/fractured shale. The casing shoe should desirably be set in a competent formation such as shale to endure high loads and pressures from kicks and avoid leakages [1].

The pressure gradient plot is a plot used to determine the correct setting depth and mudweight. The plot provides estimates of pore and fracture pressure at various depths. To determine the mud weight the median line principle is used. By choosing the mudweight in the median between the fracture pressure gradient and the pore pressure gradient, borehole instability will be minimized. Another principle as previously mentioned is to determine casing seats from the bottom of the well and upwards. This concept makes it easier to determine the least amount of casing strings required for the well [1].

The stress vs strain curve shown in **Error! Reference source not found.** describes how a material behaves when different levels of stress are applied to it. Stress is a measure of a force applied to

an object and is calculated by force divided by area. Strain is the resulting deformation and displacement of material when stress is applied. At low-stress levels, there is a linear region in the curve where stress is proportional to strain, and Hooke's law applies to this region. Yield strength marks the point of the elastic limit of the material, meaning the material will no longer return to its original shape and experience plastic deformation if we go past this point. The ultimate strength marks the maximum stress the material can handle without being seriously damaged. If we go past the point of ultimate strength the strain will increase with a decrease in stress. This is a phase where the material experiences necking. Necking means that the material pinches inwards and the cross-sectional area reduces. In this phase the material can no longer withstand the stress, causing the strain to rapidly increase. During this rapid decrease in diameter and elongation, the material will eventually snap, as indicated by the fracture point in **Error! Reference source not found..**

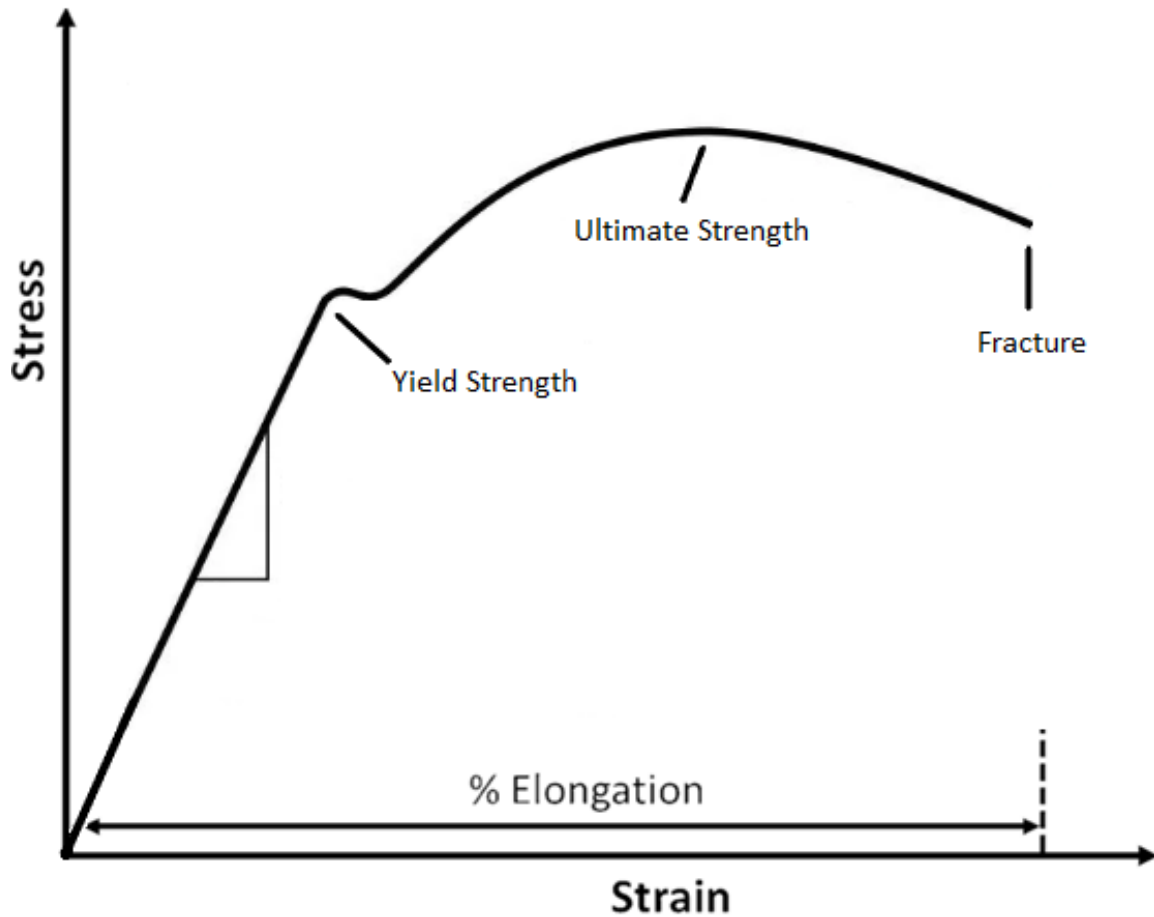

Figure 2 Stress-strain curve

Loads

Casings are subjected to different loads from various operations through the lifetime of the well. A load case describes how external pressure, internal pressure, mechanical load, and temperature are exerted over the length of a casing at a specific point in time. The major loads the string will be exposed to are burst, collapse, tension, and axial. Strength assessment of these loads on the string is essential in casing design and will thus be further discussed.

Burst:

Burst failures occur in situations where the outside of a casing is exposed to a higher pressure (P_o) than the inside of the casing (P_i).

$$P_{burst} = P_i - P_o$$

If the pressure difference exceeds the burst limit, the mechanical strength of the pipe will no longer be sufficient and might cause a burst.

$$P_{mechanical\ strength} < P_{burst}$$

A burst is a tensile failure that causes the pipe to rupture along its axis as shown in figure 3.

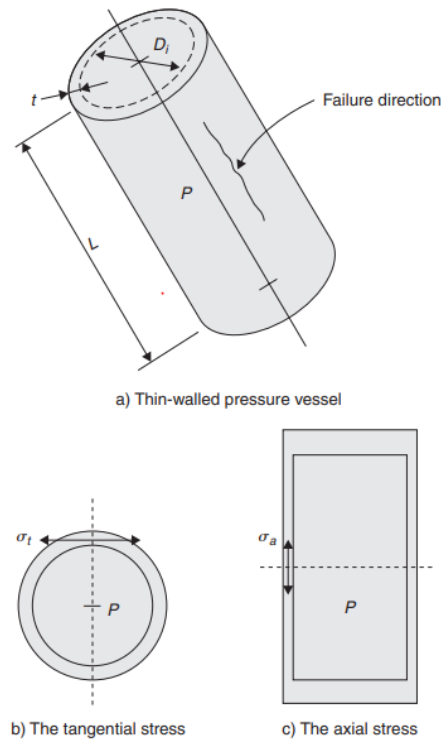

Figure 3 Stresses and failure of thin-walled vessel pressurized from the inside [1]

The internal load (P_i) mainly consists of the surface pressure and the hydrostatic pressure from the fluid in the casing. The internal load could be a planned load, for example from pressure testing. The internal load can however also be unplanned, from a tubing leak or kick. The outside load (P_o) will have a varying pressure assumption depending on the load assumption. The pressure profile can be a combination of for example pore pressure, mud base fluid, mud hydrostatic, or base fluid density of cement [2].

Burst strength can be calculated using multiple different equations. In this thesis, we will focus on API, API Barlow, and API ad-hoc for the simulations. These models as well as many other models for calculating burst strength are listed in API 5C3 [6].

Survival and service loads

In structural design, we differentiate between service loads and survival loads. Service loads are loads that more frequently occur compared to survival loads and with less severe consequences. Service loads can for example be undesirable vibrations or excessive deflections. Survival loads are rarely occurring but with higher magnitude and consequence. Examples of survival loads are burst and collapse. Both of these loads can be relevant in a design process. Survival design does however not require the casing to be operational after being subjected to the load and will instead focus on limits of survivability.

3 Design methods

This chapter will go through two different approaches to casing design namely working stress design and reliability based design.

Working stress design

Working stress design is the more traditional approach to casing design, but is also still the most used method in the petroleum industry. The method assumes a worst-case load scenario that can be imposed through the entire lifetime of the design. The criteria for this method to work is that the load multiplied by the safety factor should be lower than the design strength. This defines the working stress or allowable stress that can be applied to the casing [10].

WSD always uses the minimum yield strength for the specific material used. Going past the yield strength can result in plastic deformation or other types of deformation to the material. It is therefore important to keep within the elastic limit of the material. For casing design, minimum yield values can be found at the beginning of the casing section of DDH [10].

Safety factors for WSD can vary between companies and regions. The NORSOK standard is recommended for use on the Norwegian Continental shelf. Safety factors from NORSOK D-010 are listed for different load scenarios below [4].

Burst:	1.1
Axial:	1.25
Collapse:	1.1

Triaxial: 1.25

[8]

WSD can in some cases be applied to survival loads in addition to service loads. This is however in most cases not an optimal method for survival loads because of the model's limitations. Using WSD for survival loads can in some cases be impossible without countervailing a trade between toughness and strength [10].

Figure 4 shows a flowchart of the working stress design method. Casing grades are listed in DDH. If the selected casing doesn't satisfy the requirements for WSD, then a higher casing grade might be applied.

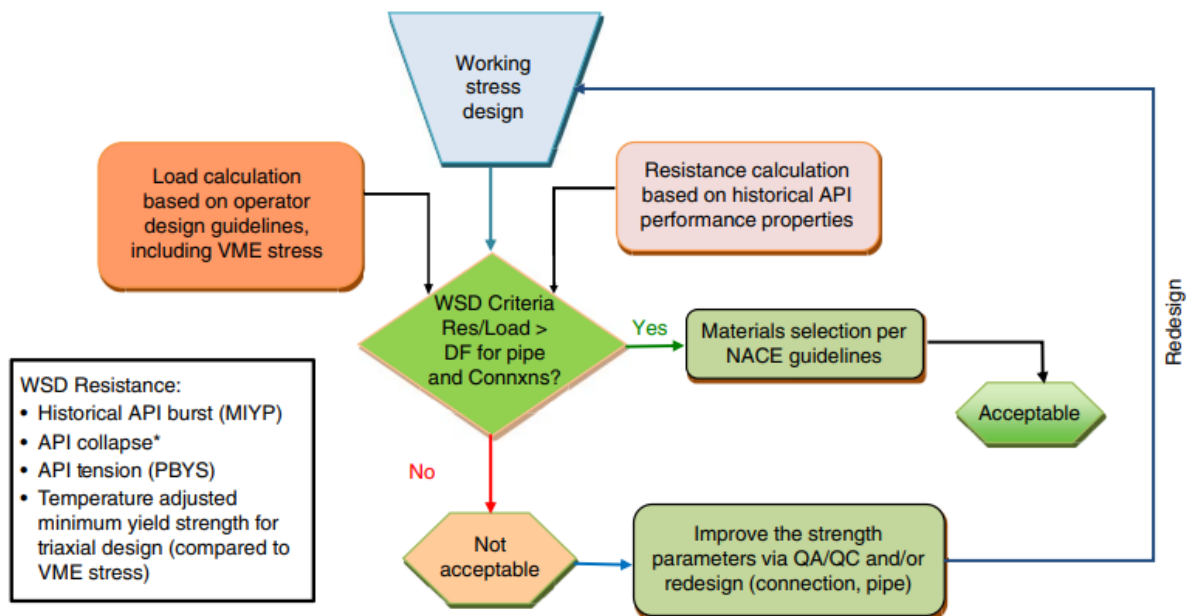

*Adjusted for internal pressure and axial tension. Connxns = connections

Figure 4 Traditional WSD approach

WSD is in general a simple method to learn and apply to many scenarios. WSD is however limited by its general safety factor and conservative nature. The safety factor does not take into consideration the severity of the load case and will use the safety factor for a high consequence failure, even if the scenario expects a low consequence failure. This leads to overdesign and unnecessary expenses [2].

Reliability based design

The reliability based approach is stochastic and uses distributions of parameters to calculate a probability of failure. Having the probability of failure as an output parameter can be very useful for visualizing different scenarios and making risk assessments in the design. RBD takes into consideration the severity of the load case when determining whether or not the selected parameters such as casing grade meets the requirements for RBD. For high consequence failures should be between 10^{-6} and 10^{-5} . For low consequence failures, the criteria should be between 10^{-3} and 10^{-2} [10].

Figure 5 shows a flowchart of the reliability based design of level 4 for survival loads.

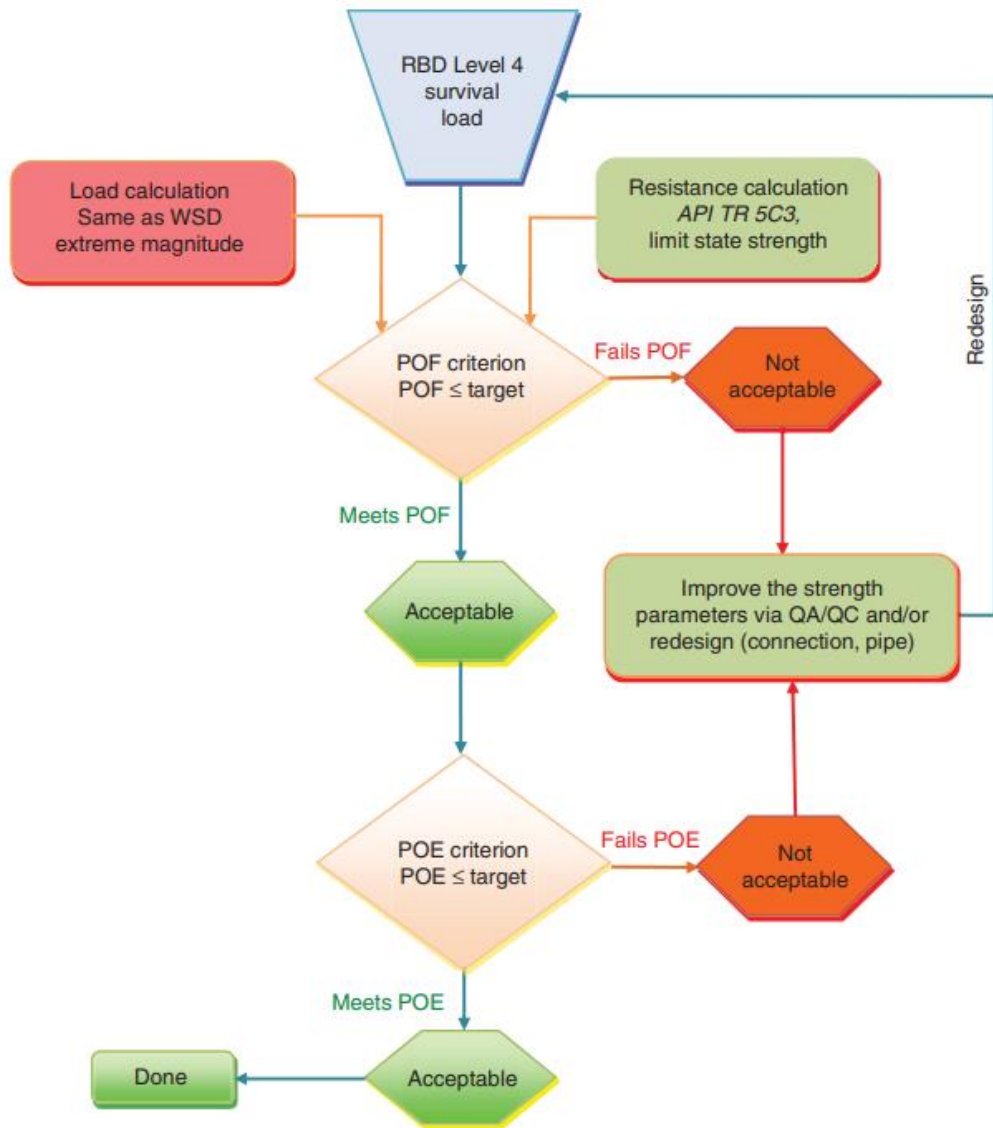

Figure 5 Flow chart, RBD4 for survival loads

RBD methods use simulations to repeat the calculations a significant number of times. After a simulation is finished we can choose spread as one of the output parameters. Spread data describes how much variation exists for a specific variable. This thesis will focus on level 4 RBD. RBD4 uses a specific value for the load scenario, while the strength calculation utilizes distributions.

4 Case study

The case study will focus on an intermediate casing with a casing size of 13 3/8 inches. Different strength models for burst strength will be tested with RBD4 as well as WSD. The parameters for the intermediate casing as well as the other casings are listed in table 1.

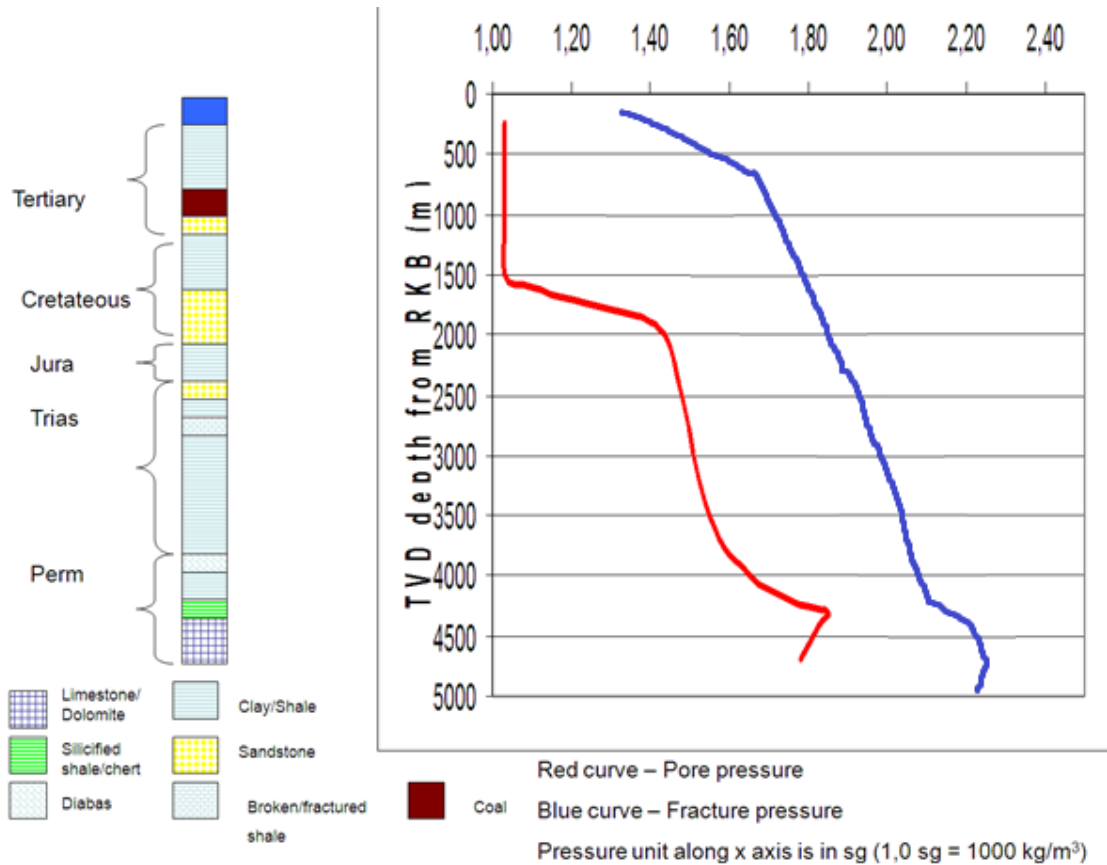

Figure 6 Pressure gradient plot

Table 1 Mud weight, casing size, and setting depth for case study

Casings	Mud weight [sg]	Casing size [inch]	Setting depth from RKB [m]
Conductor	1.3	30	50-100
Surface casing	1.4	20	300-1200
Intermediate casing	1.7	13 3/8	1300-2000

Production casing	1.8	9 5/8	2500-4000
-------------------	-----	-------	-----------

Parameters for the case study are listed below

Depth of next hole section: 4000 m

Depth of casing: 2000 m

Air gap: 30 m

Depth of seabed from RKB: 400 m

Depth of seabed: 370 m

Mud density: 1.7 sg

Formation fluid density: 0.3 sg

Strength models for burst

Strength can be calculated using different types of models. The burst models presented below are ordered from least to the most amount of safety factors and constraints.

API model

The APE equation (1.1) is the most common strength model for burst. This is the method used in working stress design and uses a reduction factor of 0.875 as a tolerance. The model uses nominal yield strength values that can be found in the casing section of DDH.

$$P_{API} = tolerance * \frac{2 * \sigma_{yield} * t}{d_o} \quad (1)$$

Probabilistic API model

The probabilistic API model uses distributions of the different parameters and model error for each parameter to calculate the result. The distributions help quantify the risk of an occurrence. Model errors help acknowledge the safety factors used, as opposed to taking the values from DDH for granted. API 5C3 lists standards requirements for the model errors and distributions.

$$P_{API} = tolerance * \frac{2 * N(mean_{\sigma}, stdv_{\sigma}) * N(mean_t, stdv_t)}{N(mean_{d_o}, stdv_{d_o})} \quad (2)$$

Probabilistic Barlow model

Unlike the API equation, the Barlow equation does not consider the tolerance. By removing this safety factor, the Barlow model more accurately reflects the actual strength required. This model also uses model error and distributions for each parameter to calculate the result. API 5C3 lists standards requirements for the model errors and distributions.

$$P_{Barlow} = \frac{2*N(\text{mean}_{\sigma},\text{stdv}_{\sigma})*N(\text{mean}_t,\text{stdv}_t)}{N(\text{mean}_{d_0},\text{stdv}_{d_0})} \quad (3)$$

Probabilistic ad-hoc model

The probabilistic ad-hoc model uses ultimate yield strength instead of nominal yield strength. This means we allow the casing to be permanently deformed. This model also ignores the tolerance, unlike the API equation. The ad-hoc models have no underlying mechanical justification or derivation. Instead, they rely on their generalization from yield equations [7]. In order to use this model, we need to make an assumption that the parameters for ultimate yield strength and nominal yield strength are the same. API 5C3 lists standards requirements for the model errors and distributions. This model, like the API model, makes use of model error and distributions. Values for ultimate yield strength can be found in the casing section of DDH.

$$P_{ad-hoc} = \frac{2*N(\text{mean}_{\sigma_{ultimate}},\text{stdv}_{\sigma_{ultimate}})*N(\text{mean}_t,\text{stdv}_t)}{N(\text{mean}_{d_0},\text{stdv}_{d_0})} \quad (4)$$

Table 2 Distribution parameters for the simulations [5]

Parameter	Table from API 5C3	Mean	Cov	Stdv
Nominal yield strength for P110	F.3	Nominal yield*1.1	0.0360	0.036 * $mean_{nominal\ yield}$
Nominal yield strength for T95	F.3	Nominal yield*1.08	0.0394	0.0394 * $mean_{nominal\ yield}$
Ultimate yield strength for T95	F.3	Ultimate yield*1.08	0.0394	0.0394 * $mean_{ultimate\ yield}$

Outer diameter	F.4	Outer diameter*1.0059	0.00181	$0.00181 * mean_{outer\ diameter}$
Wall thickness	F.4	Wall thickness*1.0069	0.0259	$0.0259 * mean_{wall\ thickness}$

Acceptance Criteria

An important factor when using Monte Carlo simulations and reliability-based approaches is to determine the acceptance criteria for failure. The criteria will determine whether the casing design is acceptable, considering its probability of failure. In well design, the criteria for failure are determined by the consequence of the failure. According to [3] the recommended criteria for high consequence failures should be between 10^{-6} and 10^{-5} . For low consequence failures, the criteria should be between 10^{-3} and 10^{-2} .

To accurately predict the probability of failure in a simulation, a sufficient number of iterations are required. Too few iterations will result in inaccurate results and the simulation will be misleading. According to [4] a general rule for a representative Monte Carlo simulation is that 10^{x+2} iterations are required for a 10^{-x} reliability. This is however a general rule and not always the case. Suryanarayana and Lewis [3] state that 10^{-8} iterations are required in RBD for survival loads when characterizing resistance distributions.

To determine the proper number of iterations in this thesis some tests were made. In the following tables: table 3, table 4, table 5 and table 6 ten simulations were performed with various number of iterations ranging from 10^3 to 10^8 . Values for the probability of failure, spread, and mean were extracted with their calculation time measured for each amount of iterations. The largest simulation with 10^8 iterations took approximately 33 minutes and calculation times were observed to be proportional between 10^5 and 10^8 . Higher amounts of iterations could also be tested, although 10^9 iterations would take approximately 10x more time with 5 hours and 33 minutes for each simulation to execute. This thesis will therefore focus on maximum 10^8 iterations in the simulations.

In table 3 values were extracted for the probability of failure. With 10^3 iterations the simulations could not find any values representing a failure in the 10 tests made. At 10^5

iterations the simulations would consistently find values for failure, although the number of failures were varying. At 10^8 iterations the 5th decimal stabilized to a value of 4. Appendix A.1.1 contains the code belonging to the simulations in table 3.

Table 3 Monte Carlo simulation data for the probability of failure with various number of iterations

Number of iterations	10^3	10^4	10^5	10^6	10^7	10^8
1	0	0	1.00E-05	3.90E-05	4.14E-05	4.187E-05
2	0	0	6.00E-05	5.70E-05	4.12E-05	4.260E-05
3	0	0	3.00E-05	4.90E-05	3.97E-05	4.204E-05
4	0	1.00E-04	8.00E-05	4.20E-05	4.35E-05	4.143E-05
5	0	0	6.00E-05	4.10E-05	4.00E-05	4.144E-05
6	0	1.00E-04	6.00E-05	4.00E-05	4.35E-05	4.157E-05
7	0	0	2.00E-05	5.10E-05	4.11E-05	4.108E-05
8	0	0	5.00E-05	4.20E-05	4.23E-05	4.215E-05
9	0	0	4.00E-05	4.70E-05	4.10E-05	4.306E-05
10	0	0	6.00E-05	3.80E-05	4.01E-05	4.176E-05
Max-value	0	1.00E-04	8.00E-05	5.70E-05	4.35E-05	4.306E-05
Min-value	0	0	1.00E-05	3.80E-05	3.97E-05	4.108E-05
Differential max-min	0	1.00E-04	7.00E-05	1.90E-05	3.80E-06	1.980E-06
Calculation time [s]	0.06	0.25	2	20	200	2000

In table 4 values were extracted for the spread of the data. It can be observed that the first digit stabilized at 10^3 iterations and the second digit stabilized at 10^4 iterations. The third digit stabilized at 10^6 iterations and the first decimal at 10^8 . Appendix A.1.1 contains the code belonging to the simulations in table 4.

Table 4 Monte Carlo simulation data for spread with various number of iterations

Number of iterations	10^3	10^4	10^5	10^6	10^7	10^8
1	112.9653	112.8339	112.9766	112.5893	112.5475	112.5418

2	113.2858	112.0406	112.1163	112.6743	112.4871	112.5350
3	109.3869	111.0918	112.5372	112.5328	112.5619	112.5414
4	111.5045	112.3883	113.1136	112.5929	112.5648	112.5484
5	106.9266	112.0045	112.0462	112.5292	112.5302	112.5493
6	110.9856	112.5677	112.5241	112.6634	112.5648	112.5395
7	113.5926	112.6995	112.4421	112.6438	112.4953	112.5515
8	109.6192	110.7645	112.0594	112.5543	112.5354	112.5379
9	113.9772	111.6963	112.8582	112.5718	112.5422	112.5518
10	115.6444	112.7227	112.1611	112.6186	112.5630	112.5425
Max-value	115.6444	112.8339	113.1136	112.6743	112.5648	112.5518
Min-value	106.9266	110.7645	112.0462	112.5292	112.4871	112.5350
Differential max-min	8.7178	2.0694	1.0674	0.1451	0.0777	0.0168
Calculation time [s]	0.06	0.25	2	20	200	2000

In table 5 values were extracted for the mean burst strength value of each simulation. The two first digits stabilized at 10^3 iterations and the third digit stabilized at 10^5 . The first digit stabilized at 10^8 iterations. Appendix A.1.1 contains the code belonging to the simulations in table 5.

Table 5 Monte Carlo simulation data for mean-value with various number of iterations

Number of iterations	10^3	10^4	10^5	10^6	10^7	10^8
1	686.4053	685.1334	684.3217	684.5617	684.6020	684.6134
2	684.3645	684.8304	684.7165	684.5192	684.5969	684.6129
3	683.5486	684.0549	684.7856	684.6534	684.6027	684.6096
4	682.1415	685.2813	684.4702	684.6218	684.6138	684.6164
5	684.5714	684.9453	684.6894	684.5594	684.6132	684.6197
6	686.4907	683.7631	684.5612	684.6365	684.6138	684.6065
7	683.4876	684.2066	684.4521	684.5254	684.5995	684.6133

8	684.2630	684.1186	684.2633	684.6275	684.6156	684.6183
9	683.6397	684.5429	684.7176	684.6591	684.6116	684.6125
10	685.5899	684.8436	684.6788	684.5931	684.6006	684.6150
Max-value	686.4907	685.2813	684.7856	684.6591	684.6156	684.6197
Min-value	682.1415	683.7631	684.2633	684.5192	684.5969	684.6065
Differential max-min	4.3492	1.5182	0.5223	0.1399	0.0187	0.0132
Calculation time [s]	0.06	0.25	2	20	200	2000

It can also be observed in table 6 that the values stabilize earlier if parameters are changed, and the probability of failure is higher. This corresponds to the general rule presented in [4] where the number of iterations required depends on the expected reliability to be achieved. Appendix A.1.1 contains the code belonging to the simulations in table 6 but the mud weight is changed from 1.7 sg to 1.8 sg.

Table 6 Monte Carlo simulation data for the probability of failure with various number of iterations

Number of iterations	10^3	10^4	10^5	10^6	10^7
1	2.00E-03	2.00E-03	1.50E-03	1.80E-03	1.80E-03
2	2.00E-03	1.20E-03	1.90E-03	1.80E-03	1.80E-03
3	3.00E-03	2.50E-03	1.70E-03	1.80E-03	1.80E-03
4	4.00E-03	2.10E-03	1.70E-03	1.80E-03	1.80E-03
5	0	2.10E-03	1.70E-03	1.80E-03	1.80E-03
6	6.00E-03	1.50E-03	1.90E-03	1.80E-03	1.80E-03
7	0	1.50E-03	1.90E-03	1.80E-03	1.80E-03
8	2.00E-03	1.40E-03	1.70E-03	1.80E-03	1.80E-03
9	2.00E-03	1.80E-03	1.60E-03	1.80E-03	1.80E-03
10	1.00E-03	1.30E-03	1.80E-03	1.80E-03	1.80E-03
max	6.00E-03	2.50E-03	1.90E-03	1.80E-03	1.80E-03
min	0.00	1.20E-03	1.50E-03	1.80E-03	1.80E-03

diff max-min	0.006	0.0013	0.0004	0	0
Calculation time [s]	0.06	0.25	2	20	200

Working stress design

It is assumed a worst-case scenario for the following calculation, with the whole well being filled with gas and the top of the casing being sealed shut. The following well is subsea, and seawater is assumed to be behind the 13 3/8 casing.

In order to calculate burst load, we first need to find the BHP by calculating the pore pressure at 4000 meters TVD as expressed in equation 5.

$$BHP = g * \rho_{pore} * depth\ of\ next\ hole\ section \quad (5)$$

$$0.0981 * 1.7 (s. g.) * 4000 (m) = 667 (bar)$$

Secondly, we calculate the external pressure at the wellbore's critical point. The depth that will result in the highest burst load will be at the wellhead. The external pressure at the wellbore's critical point is expressed in equation 6 [4].

$$P_{external} = g * \rho_{sw} * depth\ to\ seabed \quad (6)$$

$$0.0981 * 1.03 (s. g.) * 370 (m) = 37.4 (bar)$$

Because the well is closed, the internal pressure can be calculated by subtracting the BHP by the pressure from the seabed. The internal pressure calculated at the top of the casing is expressed in equation 7 [4].

$$P_{internal} = BHP - g * \rho_{ff} * (depth\ of\ open\ hole - depth\ to\ seabed - air\ gap) \quad (7)$$

$$667 (bar) - 0.0981 * 0.3 (s. g.) * (4000 (m) - 370 (m) - 30 (m)) = 561 (bar)$$

The burst load can be expressed as the pressure difference between internal and external load. The calculation of the burst load is expressed in equation 8.

$$P_{burst} = P_{internal} - P_{external} \quad (8)$$

$$561 \text{ (bar)} - 37.4 \text{ (bar)} = 523.6 \text{ (bar)}$$

NORSOK requires a safety factor of 1.1 for burst. Hence the final burst strength of the casing is as calculated below.

$$523.6 \text{ (bar)} * 1.1 = 576 \text{ (bar)}$$

With the final burst strength calculated, we can then find casings from DDHB and identify which casings that meet the requirements. The considered casing for our case study will be used in the example below.

$$0.875 * 110000 \text{ (psi)} * \frac{2 * 0.580 \text{ (in)}}{13.375 \text{ (in)}} = 8.347 * \frac{10^3 \text{ psi}}{14.5} = 576 \text{ bar}$$

According to the working stress design method, the considered casing does not satisfy the requirements after applying the NORSOK safety factor.

Reliability based design

The reliability based approach will be performed using MATLAB simulations. As previously discussed, and tested, simulations will each use 10^8 iterations as suggested by Suryanarayana and Lewis in RBD for survival loads [3]. Appendix A.1 contains the code belonging to the simulations.

This thesis will focus on RBD level 4 for survival loads. RBD4 uses a specific value for the load, unlike RBD5. RBD5 considers the load as an uncertainty parameter, further utilizing the probabilistic approach. RBD4 is therefore a more conservative approach, that is easier to implement considering it only considers strength variability and uncertainty.

The thesis will focus on three different probabilistic models API, Barlow, and ad-hoc. The models are arranged from most to least amount of safety factors and will be tested with the same

parameters before testing with increasingly weaker casings if the probability of failure is low enough.

Probabilistic API model

For the burst simulation, the parameters are listed in table 7. Distribution parameters and model errors for the simulations are listed in table 2.

Table 7 Parameters for Probabilistic API simulation

Parameter	Value
Number of iterations	10 ⁸
Welldepth	4000 m
Seawater depth	370 m
Seawater depth from RKB	400 m
Seawater density	1.03 sg
Gas density	0.3 sg
Pore pressure	1.7 sg
Gravity acceleration	0.0981 sg
Yield, CP110	110000 psi
Outer diameter	13 3/8 in
Wall thickness	0.580 in

The probabilistic API model uses distributions of the strength parameters to predict the probability of failure for the casing. This model uses nominal yield values from DDH and a reduction factor of 0.875 as a tolerance. The equation for this model is therefore comparable to the equation used in working stress design but with distributions of the strength parameters.

The simulation will use the casing grade CP110 and consider reliability based design level 4. The casing will experience a survival load where the casing is filled with gas with a density of 0.3 sg

as listed in table 7. Appendix A.1.1 contains the code belonging to this simulation. The results of the simulation are listed in table 8, and the plot is shown in figure 7.

The burst load is expressed in equation 9.

$$P_{burst} = \text{pore pressure} * \text{welldPTH} * \text{gravity acceleration} - \text{gravity acceleration} * (\text{welldPTH} - \text{seawater depth from RKB}) * \text{gas density} - \text{gravity acceleration} * \text{seawater density} * \text{seawaterdepth} \quad (9)$$

Table 8 Results from Probabilistic API simulation

Mean [bar]	Spread [bar]	P10 [bar]	P90 [bar]	Probability of failure
684.61	112.55	628.88	741.43	$4.3230 * 10^{-5}$

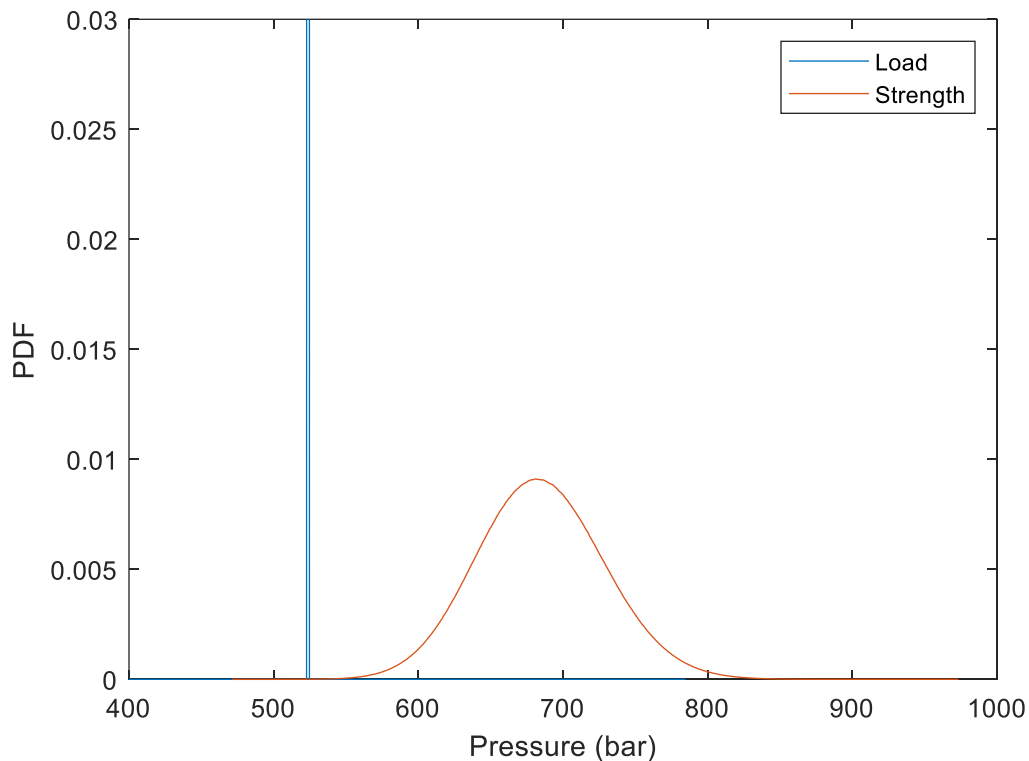

Figure 7 Probabilistic API RBD4, CP110

With the selected parameters the probabilistic API model ended up with a probability of failure of 4.3230×10^{-5} for this scenario listed in table 8. As mentioned earlier according to [3] the recommended criteria for high consequence failures should be between or under 10^{-6} and 10^{-5} . The casing hence did not meet the recommended requirements of RBD4 for survival loads.

Probabilistic Barlow model

The probabilistic Barlow model is almost similar to the API model but does not consider the tolerance in the equation. The Barlow model hence removes a safety factor and more accurately reflects the actual strength required by the casing. This model also uses distribution parameters and model errors which can be found in table 2. For the burst simulation, the parameters are listed in table 8.

Table 9 Parameters for Probabilistic Barlow simulation

Parameter	Value
Number of iterations	10^8
Welldepth	4000 m
Seawater depth	370 m
Seawater depth from RKB	400 m
Seawater density	1.03 sg
Gas density	0.3 sg
Pore pressure	1.7 sg
Gravity acceleration	0.0981 sg
Yield, CP110	110000 psi
Outer diameter	13 3/8 in
Wall thickness	0.580 in

The simulation will first test the same casing with grade CP110 before testing weaker casings. RBD4 will be considered with a survival load. The same scenario and parameters will be tested with a casing filled with gas of density 0.3 sg as listed in table 9. Appendix A.1.2 contains the

code belonging to this simulation. The results will be listed in table 10, and the plot is shown in figure 9.

Table 10 Results from Probabilistic Barlow simulation

Mean [bar]	Spread [bar]	P10 [bar]	P90 [bar]	Probability of failure
782.41	128.62	718.72	847.34	0

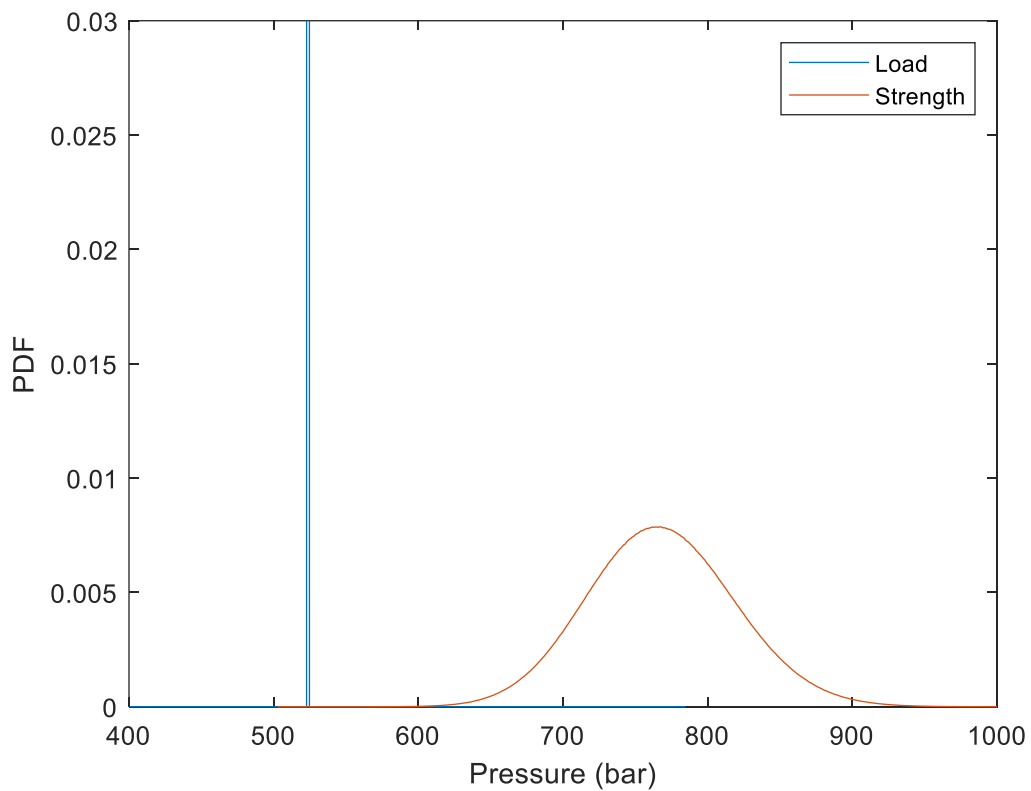

Figure 8 Probabilistic Barlow RBD4, CP110

With the selected parameters the probabilistic Barlow model ended up with 0 probability of failure. The casing, therefore, meets the requirements for survival loads in RBD4.

Since the probability of failure is under 10^{-5} we can start testing weaker casings. The next simulation will test a casing with grade RT95 with the parameters listed in table 11. Appendix

A.1.2 contains the code belonging to this simulation. The results of the simulation are listed in table 12, and the plot is shown in figure 10.

Table 11 Parameters for Probabilistic Barlow simulation

Parameter	Value
Number of iterations	10 ⁸
Welldepth	4000 m
Seawater depth	370 m
Seawater depth from RKB	400 m
Seawater density	1.03 sg
Gas density	0.3 sg
Pore pressure	1.7 sg
Gravity acceleration	0.0981 sg
Yield, CP110	105000 psi
Outer diameter	13 3/8 in
Wall thickness	0.580 in

Table 12 Results from Probabilistic Barlow simulation

Mean [bar]	Spread [bar]	P10 [bar]	P90 [bar]	Probability of failure
663.44	122.43	607.89	720.22	3.476*10 ⁻⁴

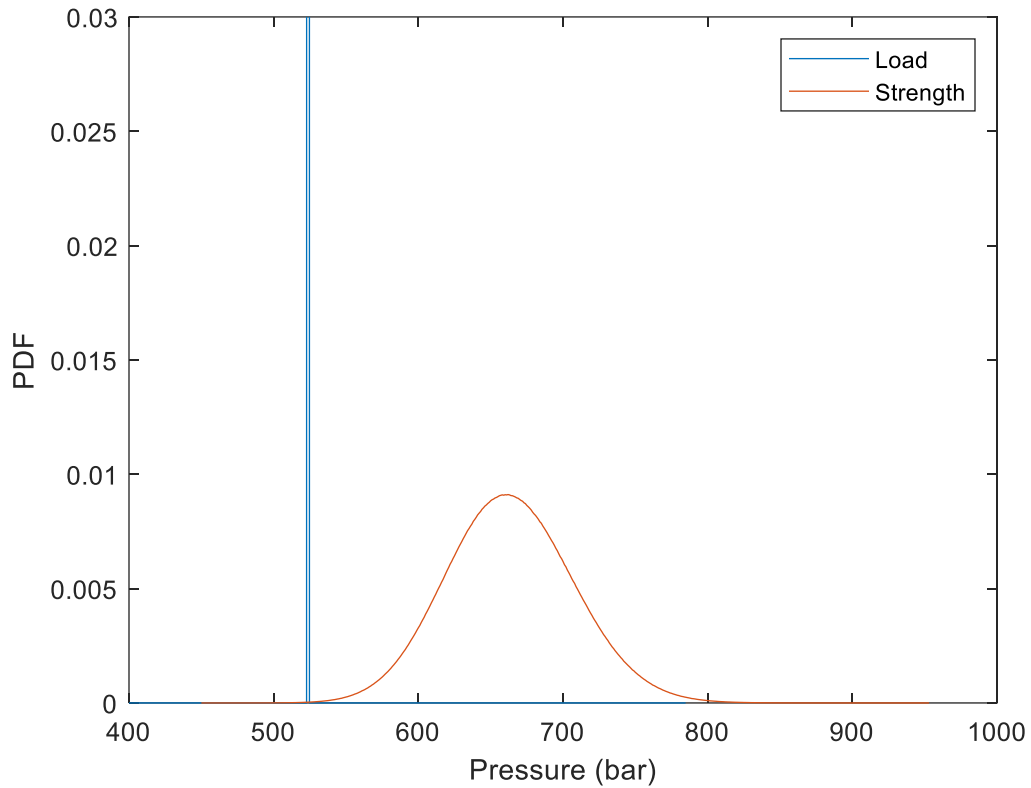

Figure 9 Probabilistic Barlow RBD4, RT95

With the chosen parameters and a casing grade of RT95, the probabilistic Barlow model ended up with a probability of failure of $3.476 \cdot 10^{-4}$ listed in table 12. The casing hence did not meet the recommended requirements for RBD4 in survival load with a casing grade of RT95. The recommended casing grade for this scenario will therefore be CP110 according to the Barlow simulation.

Probabilistic ad-hoc model

For the probabilistic ad-hoc burst simulation the parameters are listed in table 9. Model errors and distribution parameters are listed in table 2. Note that we assume the same distribution parameters for yield strength and ultimate yield strength.

Table 13 Parameters for Probabilistic as-hoc simulation

Parameter	Value
-----------	-------

Number of iterations	10 ⁸
Welldepth	4000 m
Seawater depth	370 m
Seawater depth from RKB	400 m
Seawater density	1.03 sg
Gas density	0.3 sg
Pore pressure	1.7 sg
Gravity acceleration	0.0981 sg
Ultimate yield, RT95	105000 psi
Outer diameter	13 3/8 in
Wall thickness	0.580 in

The strength equation for the probabilistic ad-hoc model is the same as for the Barlow model. The term ad-hoc means that the model uses ultimate yield instead of nominal yield. As previously discussed, ultimate yield means the material will experience an amount of stress that will cause plastic deformation.

The simulation will test a casing with grade RT95 before testing weaker casings. RBD4 will be considered for a survival load. The scenario is similar to the previous simulations with a gas-filled casing. Ultimate yield strength of 105000 psi will be used for the simulation. Appendix A 1.3 contains the code belonging to the simulation. The results will be listed in table 14, and the plot is shown in figure 11.

Table 14 Results from Probabilistic ad-hoc simulation

Mean [bar]	Spread [bar]	P10 [bar]	P90 [bar]	Probability of failure
733.28	124.25	671.78	796.03	1.110*10 ⁻⁶

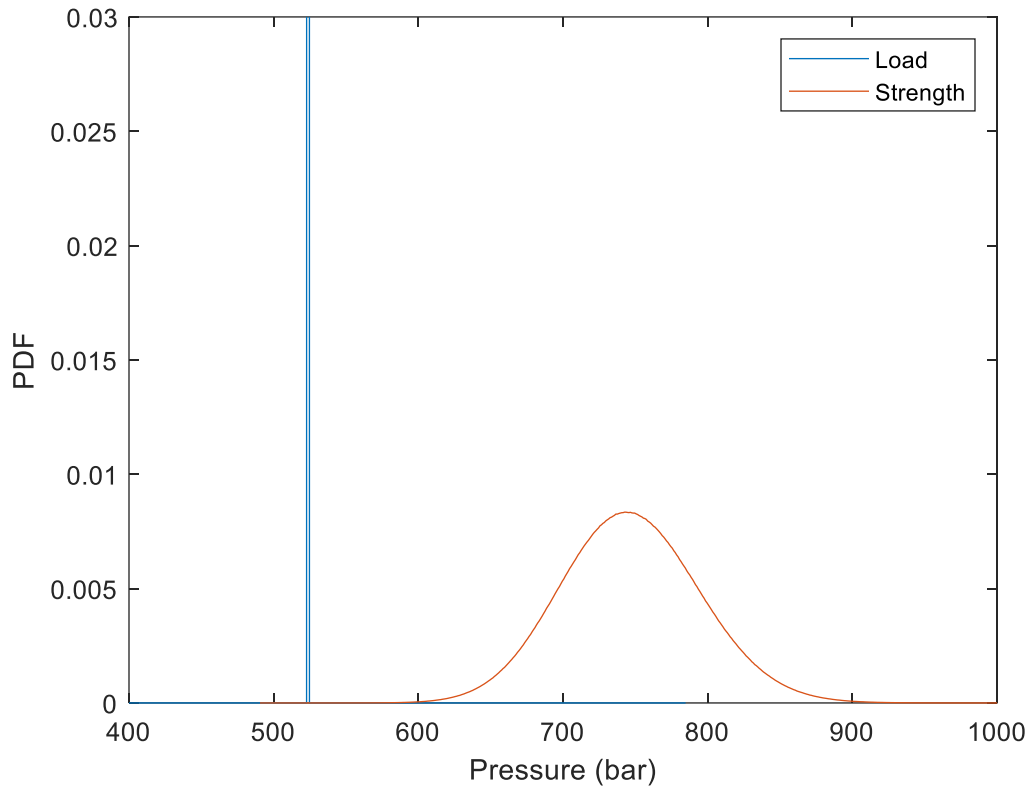

Figure 10 Probabilistic ad-hoc RBD4, RT95

With the selected parameters the probabilistic ad-hoc model calculated a probability of failure of $1.110 \cdot 10^{-6}$ listed in table 14. Hence the casing grade RT95 satisfies the requirements for survival loads in RBD4.

Simulation results

To visualize the differences between the different models, the mean, spread, and probability of failure of all the models are listed in table 15 with their corresponding casing grade and strength model.

Table 15 Results summarized from all the simulations

Burst model	Casing grade	Mean [bar]	Spread [bar]	Probability of failure
API	CP110	684.61	112.55	$4.323 \cdot 10^{-5}$
Barlow	CP110	782.41	128.62	0
	RT95	663.44	122.43	$3.476 \cdot 10^{-4}$

ad-hoc	RT95	733.28	124.25	$1.110 \cdot 10^{-6}$
--------	------	--------	--------	-----------------------

Based on the results, we can observe that the API model provides a smaller spread than the Barlow and ad-hoc model. The API model did not allow a casing grade of CP110 with a probability of failure higher than the recommended requirements of 10^{-6} to 10^{-5} for high consequence failures. In comparison the Barlow model calculated a probability of failure of 0, meaning the simulation did not pick up any failures in the 10^8 iterations it tested. The Barlow model achieved this probability by removing the reduction factor of 0.875, resulting in higher strength. The Barlow model did however not allow us to use any lower casing grades with a probability of failure of $3.476 \cdot 10^{-4}$ for the RT95 grade casing. The ad-hoc model further stretched the probabilistic strength of the casing by using ultimate yield strength values instead of nominal yield strength. This resulted in a low enough probability of failure to use a casing grade of RT95.

5 Discussion and conclusion

Working stress design is today the most common design method in the petroleum industry. The working stress design method is easy to learn and uses multiple safety factors, resulting in a relatively safe design. The reliability based casing design method is a probabilistic approach to casing design. In comparison, the reliability based approach can initially be harder to understand, because it adds a layer of complexity to the calculations. The results from the simulations and the working stress design method shows how the different model and methods recommend different casing grades for the same scenario. The working stress design is the most conservative of the methods tested for a burst scenario and did not satisfy the requirements for the CP110 casing grade after applying the NORSOK safety factor. Testing the same casing for RBD4 showed the CP110 casing did satisfy the requirements for the Barlow and ad-hoc model, and a lower grade of RT95 could also be used if we allow the casing to plastically deform.

In RBD the requirements of a casing depend on whether the failure is low consequence or high consequence. The RBD method calculates a probability of failure to determine how safe the design is and whether the value is lower than the recommended probability of failure. The requirements for high consequence and low consequence failures in this thesis were based on the recommendations from [3]. The requirements can however be subjective and be determined by experience since the probability of failure is known. WSD determines whether a design meet the requirements by whether or not the strength of the material is larger than the expected load with an added safety factor. Hence WSD does not take into account how high the consequence of failure is and doesn't specify how safe the casing actually is.

RBD consists of different models with different amount of safety factors and restrictions. Some models such as Barlow allow us to remove a safety factor, and ad-hoc additionally allows us to use different values for yield strength. RBD can therefore be adapted to the specific outcome that is desired for the casing. Ultimate strength can be used if we allow the casing to plastically deform. Going past the point of ultimate strength can also be an option if the reusability of the casing is not of importance. The RBD method helps us visualize where the different safety

factors are applied and to which parameter. In comparison safety factors in WSD are mostly hidden and taken for granted. RBD uses safety factors from the API 5C3 standards while WSD uses Norsok standards.

RBD is dependent on Monte Carlo simulations to calculate the probability of failure. These simulations can have significant calculation time if the number of iterations is high. The lower the target probability of failure the higher number of iterations are required. The advantage of using a high number of iterations is that the probability of failure becomes more consistent and accurate. With the chosen parameters in this thesis, we could see the values for mean, spread, and probability of failure gradually stabilizing when increasing the number of iterations. After further testing, it was discovered that the simulation results stabilize faster if the probability of failure is higher. This confirmed the general rule provided by [4] that to achieve a 10^{-x} reliability, 10^{x+2} number of iterations are required in the simulation. The testing also showed that 10^8 number of iterations were appropriate for the specific parameters and requirements we chose for the case study.

There are many situations where RBD can be applied. RBD can in some cases provide a cheaper design compared to traditional WSD methods. RBD can therefore be used in most cases for cost reduction. RBD can also be used for situations where it's hard to determine which casing is correct to use because of uncertain parameters. RBD doesn't necessarily have to be a replacement for WSD but can be used as an additional level of complexity to get a better understanding of the risks associated with a specific casing. RBD can therefore be useful in situations where the consequence of failure is high. Hence it is a useful method in burst scenarios, where the consequence of failure can be damage to the environment or in the worst-case loss of life.

The conclusion of this thesis is that level 4 reliability based casing design is well-suited for burst scenarios. It adds another level of complexity and options that are useful for risk assessments, and can in some cases provide a cheaper well design.

6 Recommendations

It takes time to get familiar with the RBD methods and models. Seeking guidance from supervisors and others can be a huge timesaver and clear up a lot of confusion that might occur around this methodology.

The API 5C3 standard can be hard to read and I would not recommend reading it like a normal book. Focus on getting an overview of the data that is useful for the specific models that are applied.

This thesis focused on a burst scenario. RBD can however also be applied to biaxial, triaxial, and collapse analyses using simulation methods such as Monte Carlo.

Simulations can be time-consuming if the number of iterations is high. Computers do however only use around 10 % of their CPU power during the simulation. There is therefore large room for improvement in the effectiveness of these simulations. This aspect of Monte Carlo simulations could be further researched by either running multiple simulations simultaneously or finding a more effective method of executing the simulations.

References

1. Aadnøy, B. S. (2010). *Modern Well Design*. Stavanger: CRC Press/Balkema.
2. Bernt S. Aadnoy, I. C. (2009). *Advanced drilling and well technology*. Society of Petroleum Engineers.
3. Kjell Kåre Fjelde, D. G. (2021). PROBABILISTIC MODELS FOR KICK TOLERANCE. *OMAE2021-63779*. Proceedings of the ASME 2021 40th International Conference on Ocean, Offshore and Arctic Engineering.
4. Nyhus, K. (2019). *A comparison of working stress design and reliability based design, Master's thesis*. Stavanger: University of Stavanger. Retrieved from <https://uis.brage.unit.no/uis-xmlui/handle/11250/2634142>

5. P. V. Suranaraya, D. B. (2021). *A Reliability-Based Approach for Survival Design in Deepwater and High-Pressure/High-Temperature Wells*. Texas, USA: Blade Energy Partners.
6. P. V. Suryanaraya, D. B. (2016). *A Reliability-Based Approach for Survival Design in Deepwater and High-Pressure/High-Temperature Wells*. Texas, USA: Blade Energy Partners.
7. *Petroleum and natural gas industries-Equations and calculations for the properties of casing, tubing, drill pipe and line pipe used as casing or tubing* (ISO/TR 10400 First edition ed.). (2007). Geneva, Switzerland: ISO.
8. Prassl, W. F. (2000). *Drilling Engineering*. Curtin University of Technology.
9. *Well integrity in drilling and well operations* (Norsok D-010:2021+AC2 Rev 5 ed.). (2021). Standards Norway.
10. P. V. Suranaraya, D. B. (2021). *A Reliability-Based Approach for Survival Design in Deepwater and High-Pressure/High-Temperature Wells*. Texas, USA: Blade Energy Partners.

Appendix

A.1 Monte Carlo Simulation MATLAB codes

A.1.1 Probabilistic APE Model

```
clc
clear
```

```
N = 10000000; % Number of iterations in MonteCarlo simulation
tic
```

```
YS0 = 110000; % This is the yield strength of casing in psi
OD0 = 13.375; % this is the casing outer diameter in inches
t0 = 0.580; % this is the minimum or average casing wall thickness in inches
ppore=1.7;
welldepth = 4000; %m TVD of next section drilled from RKB
seawaterdepth = 370; %m
seawaterdepthRKB = 400; %m depth from RKB
seawaterdensity = 1.03; %sg
```



```

densitygass = 0.3; %sg
g = 0.0981; %sg acceleration due to gravity

psurf=zeros(1,N);
pburststrength = zeros(1,N);

counter=0; % Variable that is used to calculate the percentage of having
          % innerpressure larger that burststrength.

for j = 1:N % Start of MonteCarlo loop

% YIELD STRENGTH
YSMean = YS0*1.1; % Table F3, page 163 ISO/TR 10400
YSSdev = YSMean*0.036; % Table F3, page 163 ISO/TR 10400
% used in paper SPE 1780907 PA.
YS = normrnd(YSMean,YSSdev);

% OUTER DIAMETER
ODMean = OD0*1.0059;
ODSdev = ODMean*0.00181; % Table F4 page 166 in ISO 10400 is used.

OD = normrnd(ODMean,ODSdev);

% WALL THICKNESS, Table F4 page 166 second column
tmean = t0*1.0069;
tSdev = tmean*0.0259;

t = normrnd(tmean,tSdev);

pburststrength(1,j)=0.875*(2*YS*t)/OD; % In psi

% Table B5, page 107 ISO/TR 10400

pburststrength(1,j)= pburststrength(1,j)*normrnd(1.08,0.05);

% Convert from psi to bar

pburststrength(1,j)= pburststrength(1,j)/14.5;

psurf(1,j)=ppore*welldepth*g-(welldepth-seawaterdepthRKB)*densitygass*g-
g*seawaterdensity*seawaterdepth;

% here we count number of times the strength pressure is exceeded
if(psurf(1,j)>pburststrength(1,j))
counter=counter+1;
end

end % End of MonteCarlo loop

```

```

    prob=counter/N; % load pressure > strength

% Plot probability density functions
e=min(pburststrength(1,:));
f=max(pburststrength(1,:));
s=[e:1:f];
[c,d]=hist(pburststrength(1,:),s);

h=min(psurf(1,:));
f=max(psurf(1,:));
w=[h:1:f];

[a,b]=hist(psurf(1,:),w);

plot(b,a/N,d,c/N);
legend('Load','Strength')
xlabel('Pressure (bar)')
ylabel('PDF')
axis([400,1000,0,0.03]);

% printed properties
average = mean(pburststrength(1,:))
percentile50=median(pburststrength(1,:));
percentile10=prctile(pburststrength(1,:),10);
percentile90=prctile(pburststrength(1,:),90);

spread = percentile90-percentile10
Probability_of_failure = prob
calculation_time = toc

```

A.1.2 Probabilistic Barlow Model

```

clc
clear

N = 100000000; % Number of iterations in MonteCarlo simulation

YS0 = 95000; % This is the yield strength of casing in psi
OD0 = 13.375; % this is the casing outer diameter in inches
t0 = 0.580; % this is the minimum or average casing wall thickness in inches
ppore=1.7;
welldepth = 4000; %m TVD of next section drilled from RKB
seawaterdepth = 370; %m
seawaterdepthRKB = 400; %m depth from RKB
seawaterdensity = 1.03; %m
densitygass = 0.3; %sg
g = 0.0981; %sg acceleration due to gravity

psurf=zeros(1,N);
pburststrength = zeros(1,N);

```

```

counter=0; % Variable that is used to calculate the percentage of having
           % innerpressure larger that burststrength.

for j = 1:N % Start of MonteCarlo loop

% YIELD STRENGTH
YSMean = YS0*1.08; % Table F3, page 163 ISO/TR 10400
YSSdev = YSMean*0.0394; % Table F3, page 163 ISO/TR 10400
% used in paper SPE 1780907 PA.
YS = normrnd(YSMean,YSSdev);

% OUTER DIAMETER
ODMean = OD0*1.0059;
ODSdev = ODMean*0.00181; % Table F4 page 166 in ISO 10400 is used.

OD = normrnd(ODMean,ODSdev);

% WALL THICKNESS, Table F4 page 166 second column
tmean = t0*1.0069;
tSdev = tmean*0.0259;

t = normrnd(tmean,tSdev);

pburststrength(1,j)=(2*YS*t)/OD; % In psi

% Table B5, page 107 ISO/TR 10400
pburststrength(1,j)= pburststrength(1,j)*normrnd(1.08,0.05);

% Convert from psi to bar
pburststrength(1,j)= pburststrength(1,j)/14.5;

psurf(1,j)=ppore*welldepth*g-(welldepth-seawaterdepthRKB)*densitygass*g-
g*seawaterdensity*seawaterdepth;

% here we count number of times the strength pressure is exceeded
if(psurf(1,j)>pburststrength(1,j))
    counter=counter+1;
end

end % End of MonteCarlo loop

prob=counter/N; % load pressure > strength

% Plot probability density functions
e=min(pburststrength(1,:));
f=max(pburststrength(1,:));
s=[e:1:f];

```

```

[c,d]=hist(pburststrength(1,:),s);

h=min(psurf(1,:));
f=max(psurf(1,:));
w=[h:1:f];

[a,b]=hist(psurf(1,:),w);

plot(b,a/N,d,c/N);
legend('Load', 'Strength')
xlabel('Pressure (bar)')
ylabel('PDF')
axis([400,1000,0,0.03]);

% printed properties
average = mean(pburststrength(1,:))
percentile50=median(pburststrength(1,:));
percentile10=prctile(pburststrength(1,:),10);
percentile90=prctile(pburststrength(1,:),90);
spread = percentile90-percentile10
Probability_of_failure = prob

```

A.1.3 Probabilistic ad-hoc Model

```

clc
clear
N = 10000000; % Number of iterations in MonteCarlo simulation

YS0 = 105000; % This is the ultimate yield strength of casing in psi
OD0 = 13.375; % this is the casing outer diameter in inches
t0 = 0.580; % this is the minimum or average casing wall thickness in inches
ppore=1.7;
welldepth = 4000; %m TVD of next section drilled from RKB
seawaterdepth = 370; %m
seawaterdepthRKB = 400; %m depth from RKB
seawaterdensity = 1.03; %m
densitygass = 0.3; %sg
g = 0.0981; %sg acceleration due to gravity

psurf=zeros(1,N);
pburststrength = zeros(1,N);

counter=0; % Variable that is used to calculate the percentage of having
           % innerpressure larger that burststrength.

for j = 1:N % Start of MonteCarlo loop

% YIELD STRENGTH
YSMean = YS0*1.08; % Table F3, page 163 ISO/TR 10400
YSSdev = YSMean*0.0394; % Table F3, page 163 ISO/TR 10400
% used in paper SPE 1780907 PA.
YS = normrnd(YSMean,YSSdev);

```

```

% OUTER DIAMETER
ODMean = OD0*1.0059;
ODSdev = ODMean*0.00181; % Table F4 page 166 in ISO 10400 is used.

OD = normrnd(ODMean,ODSdev);

% WALL THICKNESS, Table F4 page 166 second column
tmean = t0*1.0069;
tSdev = tmean*0.0259;

t = normrnd(tmean,tSdev);

% Calculate strength with Barlows formula (note 0.875 can be used
% in front to be more conservative.

pburststrength(1,j)=(2*YS*t)/OD; % In psi

% Correct for model error. Here master thesis used Ad Hoc Barlow,
% Table B5, page 107 ISO/TR 10400

pburststrength(1,j)= pburststrength(1,j)*normrnd(1.08,0.05);

% Convert from psi to bar

pburststrength(1,j)= pburststrength(1,j)/14.5;

psurf(1,j)=ppore*welldepth*g-(welldepth-seawaterdepthRKB)*densitygass*g-
g*seawaterdensity*seawaterdepth;

% here we count number of times the strength pressure is exceeded
if(psurf(1,j)>pburststrength(1,j))
    counter=counter+1;
end

end % End of MonteCarlo loop

prob=counter/N; % load pressure > strength

% Plot probability density functions
e=min(pburststrength(1,:));
f=max(pburststrength(1,:));
s=[e:1:f];
[c,d]=hist(pburststrength(1,:),s);

h=min(psurf(1,:));
f=max(psurf(1,:));
w=[h:1:f];

[a,b]=hist(psurf(1,:),w);

```

```
plot(b,a/N,d,c/N);
legend('Load','Strength')
xlabel('Pressure (bar)')
ylabel('PDF')
axis([400,1000,0,0.03]);
```

```
%printed properties
```

```
average = mean(pburststrength(1,:))
percentile50=median(pburststrength(1,:));
percentile10=prctile(pburststrength(1,:),10);
percentile90=prctile(pburststrength(1,:),90);
```

```
spread = percentile90-percentile10
Probability_of_failure = prob
```