



Faculty of Science and Technology

BACHELOR'S THESIS

Study program/Specialization: Structural Engineering / Konstruksjonsteknikk	Spring semester; 2023 Open/Restricted access; Open
Writer: - WELDU, WOLDAY - ROSE, MEDHANIE KIFLE - GHEBRETINSAE, FITHAWI	(Writer's signature) <hr/> <hr/> <hr/>
Faculty supervisor: Sudath C. Siriwardane Assistant supervisor(s): Fredrik Bjørheim	
Thesis title: STRUCTURAL PERFORMANCE OF A RAILWAY TRUSS BRIDGE MODEL: DESIGN, FABRICATION AND MODEL TESTING.	
Credits (ECTS): 20	
Key words: - Truss bridge: <ul style="list-style-type: none">○ Design○ Fabrication and Testing○ SAP2000 FEM	Pages: 67 +enclosure: 02 Stavanger, May-29- 2023. Date/year

BACHELOR THESIS

STRUCTURAL PERFORMANCE OF A RAILWAY TRUSS BRIDGE DESIGN, FABRICATION, FEM AND MODEL TESTING.

DEPARTMENT OF MECHANICAL AND STRUCTURAL ENGINEERING AND
MATERIALS SCIENCE, UNIVERSITY OF STAVANGER, NORWAY.

May 2023

AUTHORS:

WELDU WOLDAY	Stavanger, 2023
ROSE MEDHANIE KIFLE	Stavanger, 2023
FITHAWI GHEBRETINSAE	Stavanger, 2023

ACKNOWLEDGEMENT

This bachelor's thesis is the final work required to fulfill the bachelor's degree in structural engineering, at the Department of Mechanical Engineering, Structural Engineering and Material Science, University of Stavanger, Norway.

We would like to thank Professor Sudath C.Siriwardane and Fredrik Bjørheim for their invaluable guidance and mentorship throughout the duration of this Bachelor's thesis. Their expertise, knowledge, and insightful feedback have played a crucial role in shaping the direction and quality of our work. We are also grateful to Senior Engineer Samdar Kakay for his valuable assistance during the experimental performances. His expertise, technical support, and guidance have been instrumental in conducting the experiments and obtaining meaningful results. We would like to express our appreciation to the members of our thesis group for their constructive discussions and cooperative efforts throughout the thesis period. Their active participation and collaboration have greatly enriched our research and contributed to the overall success of this project.

“I would like to express my gratitude to my family for their unwavering support, patience, and understanding throughout this journey. Their love and encouragement have been a constant source of motivation and inspiration.”

Weldu Wolday

29.05.2023, Stavanger, Norway

“I am profoundly grateful to my family for their unwavering support, my mentors for shaping my growth, and my dear friends for their invaluable presence. Your love, guidance, and unwavering belief in me have made an indelible impact on my life.”

Rose Kifle

29.05.2023, Stavanger, Norway

“My special thanks to my wife and my children for their endless support and motivation all the way to this bachelor's degree.”

Fithawi Ghebretinsae

29.05.2023, Stavanger, Norway

CONTENTS

CHAPTER 1	INTRODUCTION	1
CHAPTER 2	LITERATURE.....	2
2.1	Types of bridges:	2
2.2	Aluminum bridges	5
2.3	Structural Materials	6
2.3.1	Structural Steel.....	7
2.3.2	Aluminum as Construction material	8
2.4	Design theory.....	12
2.4.1	Loads and load distribution in bridges.....	12
2.4.2	Classification of cross-section	13
CHAPTER 3	DESIGN AND FABRICATION OF ALUMINUM TRUSS BRIDGE MODEL	15
3.1	Predesign of the Al truss bridge	15
3.2	Design of Al Truss bridge Model.....	16
3.3	Fabrication of the Final Al Truss bridge	16
CHAPTER 4	THEORETICAL ANALYSIS OF A TRUSS BRIDGE.....	20
4.1	Design assumptions	20
4.2	Truss bridge design using ultimate limit state (ULS).....	20
4.2.1	Determine the design axial load (N _{Ed}).....	20
4.2.2	Determine the cross section.	21
4.2.3	Class classifications of the cross-section	21
4.2.4	Determining cross-sectional design compression resistance N _{c, Rd}	23
4.2.5	Check the compression design load is greater than design load.....	24
4.2.6	Find the buckling design load N _{b, Rd}	24
4.2.7	Design check for buckling.	25
4.2.8	Determine displacement at a specified point:	25
4.3	Results of theoretical analysis	28
CHAPTER 5	FINITE ELEMENT METHODE (FEM)	31
5.1.1	SAP2000	31
5.2	2D and 3D Truss Bridge Modeling using SAP2000.	31
5.3	Results From Numerical Analysis	33
5.3.1	2D truss bridge.....	33

5.3.2 3D truss bridge	37
CHAPTER 6 EXPERIMENTAL INVESTIGATION	43
6.1 3D Truss Bridge Experimental Test	43
6.1.1 Tools and testing machines.	43
6.2 Results from Experimental Test	45
6.2.1 Static Load	45
6.3 Dynamic load.....	48
6.3.1 Low speed 22cm/s.....	49
6.3.2 High-speed 43cm/s.....	50
6.3.3 Hard break high speed	51
CHAPTER 7 RESULT DISCUSSION / COMPARISON	52
7.1 Static result comparison.....	52
7.2 Dynamic result comparison	54
CHAPTER 8 CONCLUSION	55
Reference.....	56
Appendix	58

TABLES

Table 1: Nominal values of yield strength f_y and ultimate tensile strength f_u for hot rolled structural steel.	7
Table 2: Aluminum Alloys.....	8
Table 3 Material properties of structural steel Vs Aluminum (Eurocode 3 - Design of Steel Structures - Part 1-5 Plated, n.d.) and from table3.2c (EN 1999-1-1:2007+A1:2009, 2009).....	10
Table 4 Aluminum 6082-T6 Vs 1050A H14 chemical composition and yield strength (Aluminum 6082-T6, n.d.)	11
Table 5: Specific Weight of Different Materials.....	13
Table 6: Influence line at member lk, lc, kj, cj and bc.....	27
Table 7: Results of Theoretical Analysis	28
Table 8: Results of Theoretical Analysis when the load is 197.58N	29
Table 9: Results of theoretical calculated deflection at each node in mm by 197.58N	30
Table 10: Results of theoretical calculated deflection at each node in mm by 70.12N.....	30
Table 11: Deflection results at joint located on bottom cord of 2D truss bridge from SAP2000.	34
Table 12: 2D Truss bridge members force results from SAP2000, Static load 125N.....	35
Table 13: Results from SAP2000 3D static load of 70N at joint D.	38
Table 14 SAP results of multi-step moving load of 219.68N.....	41
Table 15 Average Strain values obtained from strain gauge at joint D.....	45
Table 16 Average strain values measured at joint B due to Static load.	47
Table 17 Strain, Stress, member Forces from high speed 22.4kg moving truck.	50
Table 18: Element Forces and Stress from Experimental, Analytical and SAP from static analysis when 70N load is applied at joint D.....	52
Table 19: Results from experimental lab, hand calculations vs SAP2000 a static load applied at mid-span of the 3D truss bridge.	53

FIGURES

Figure 1: Types of bridges. a) Arch bridge. b) Suspension/cable c) Beam bridge. d) Truss bridge.....	2
Figure 2: Warren truss (with verticals).....	3
Figure 3: Truss bridge members (Hibbeler structural analysis chapter 3. page:82.....	4
Figure 4: Gusset plate connection.....	5
Figure 5: Aluminum bridges in Norway and Canada.....	6
Figure 6: Aluminum Alloy series number descriptions	8
Figure 7: Galvanic –reaction chart, where green represents lower corrosion risk and red high corrosion risk. Ref (www.grabbepro.com)	9
Figure 8 Strain Stress Aluminum Vs Steel.....	10
Figure 9: Pre -experimental model design 1500x250x250mm and its cross-sections	15
Figure 10: Flatt Al sheet metal before folded.	16
Figure 11: Fabricated Al truss bridge	17
Figure 12: Angle sections used in the truss fabrication.	17
Figure 13: Pin joint, hole diameter 3.3mm and screw M3 20mm length	18
Figure 14: Al Truss bridge	18
Figure 15: A Guillotine Plate Shearing Machine with a 12mm and 14B Plate folder machine.	19
Figure 16: Slenderness parameter for classification of parts of cross-sections from (EN 1999-1-1:2007+A1:2009, 2009).....	22
Figure 17: Slenderness parameters from table 6.2 (EN 1999-1-1:2007+A1:2009, 2009).....	22
Figure 18: Buckling reduction factor ρ_c for class B without welds, symmetrical outstands from figure 6.5 (EN 1999-1-1:2007+A1:2009, 2009).....	23
Figure:19 Constants C from figure 6.3 in (EN 1999-1-1:2007+A1:2009, 2009).....	23
Figure 20: Reduction factor for flexural buckling figure 6.11 (EN 1999-1-1:2007+A1:2009, 2009).....	25
Figure 21: The design truss bridge with all members.....	26
Figure 22:Influence line at truss bridge member lk, lc, kj, cj and bc	28
Figure 23: 2D-truss bridge model.....	32
Figure 24: Angle section and its section properties	32
Figure 25: Multistep Moving Load.....	33
Figure 26: 2D truss bridge SAP model, including joints, members and load.	33
Figure 27: Deflection results from SAP2000 of joints located at bottom cord of the 2D truss bridge.....	34
Figure 28 Deformed shape U_z of the 2D- Al truss bridge, static 125N load applied at midspan.	34
Figure 29 Member force results from SAP 2D static load of 125N at joint D.....	36
Figure 30 Stress results from SAP 2D static load of 125N at joint D.....	36
Figure 31: Displacement results from SAP 3D truss bridge model due to 70N static load located at joint D.	37
Figure 32: Deformation when a static load is applied at mid span of 3D truss bridge from SAP2000.....	37
Figure 33: Member forces of 3D truss static load applied at mid-span from SAP2000.....	39
Figure 34 Displacement results from SAP multi-step analysis at each joint of the bottom cords.....	40
Figure 35:Deformation (U_z) results 3D dynamic analysis from SAP2000	40
Figure 36: Dynamic 3D- member forces from SAP2000.....	40
Figure 37: Stress results from SAP of a multi-step moving load 219.68N.....	42
Figure 38:Typical one directional strain gauge and bridge amplifier of Quantum-X family	44
Figure 39 The truck model used in the experimental test.....	44
Figure 40: Average strain from experimental test at joint D due to static load	45
Figure 41 Strain values from static experimental test of the 3D truss bridge.....	46

Figure 42 Deflection of truss bridge due to static load at joint D.....	46
Figure 43: Strain at joint B due to static load.....	47
Figure 44:Deflection at mid span of the truss bridge from experimental test using gauge.	48
Figure 45 experimental displacement results of 3D Al truss bridge loaded with a moving truck measured at floor beam of joint D.	48
Figure 46: Strain at truss member vs time due to a low-speed multi-step moving truck.	49
Figure 47: Max-strain at truss members due to low speed moving truck.	49
Figure 48: Strain at truss member vs time due to a high-speed multi-step moving truck.	50
Figure 49: Max-strain at truss members due to high-speed moving truck.	50
Figure 50 Strain due to hard breaking of a high-speed moving truck	51
Figure 51: Comparing force results from theoretical, experimental and numerical analysis.	53
Figure 52: Stress results of 3D truss bridge from experimental and SAP2000.....	54
Figure 53: Displacement at each joint from experimental and SAP2000.....	54

EQUATIONS

Equation 1.....	20
Equation 2.....	20
Equation 3.....	21
Equation 4.....	21
Equation 5.....	21
Equation 6.....	22
Equation 7.....	23
Equation 8.....	23
Equation 9.....	23
Equation 10.....	24
Equation 11.....	24
Equation 12.....	24
Equation 13.....	24
Equation 14.....	24
Equation 15.....	25
Equation 16.....	26
Equation 17.....	43
Equation 18.....	43

Abbreviation:

FEM	Finite element method
DOF	Degree of freedom
Al	Aluminum
N_{Ed}	Design value of the axial force
N_{Rd}	Design resistance force
N_{cr}	Critical load
$N_{c, Rd}$	Compression design resistance force
$N_{b, Rd}$	Buckling design resistance force
GF	Gauge Factor
C	Compression
T	Tension
UIS	University of Stavanger
MPa	Mega-pascal

CHAPTER 1 INTRODUCTION

The construction of bridges has been a significant area of focus in civil engineering, with truss bridges being a popular choice due to their structural efficiency and economy. In recent years, there have been a growing interest in using light-weight materials such as aluminum in bridge constructions due to their high strength-to-weight ratio and corrosion resistance properties. The objective of this bachelor's thesis is to design an aluminum truss bridge using the design theory, to analysis the truss bridge design using Finite Element Method (FEM) and to fabricate a test truss bridge model at the laboratory of university of Stavanger.

This bachelor thesis project involves the design process, where the structural design analysis and parameters of the truss bridge are determined. SAP2000, an advanced FEM software tools is used for this purpose. This software assists for accurate modeling and analysis of the bridge's behavior under various loading conditions. The fabrication process requires careful attention to detail and precision, ensuring that the individual truss members are accurately manufactured and assembled according to the design specifications. The experimental analysis provides valuable data that helps to validate the design assumptions and assess the actual performance of the aluminum truss bridge. This analysis contributes to a better understanding of the behavior and response of the bridge under real-life conditions ensuring its safety.

The design phase considers from the actual truss bridge of 38.5m span by rescaling it into small size of 3x0.5x0.5m. Moreover, the fabrication process involves the actual construction of the truss bridge using aluminum as the primary material. The bridge was subjected to a maximum load of 140.60 and 219.68N in static and dynamic cases respectively. A maximum stress value of 3.69 N/mm² in the static and 7.02 N/mm² from the dynamic load case are obtained from experimental test. Moreover, the truss bridge was designed to have maximum allowable design stress of 12.35 N/mm² and it was capable to carry the experimental test load safely.

Overall, this bachelor's thesis focuses on the comprehensive study of designing, fabricating, and analyzing of a truss bridge made of aluminum metal. Moreover, the group have learned the theoretical design analysis, the importance of advanced finite element modeling and the challenges of practical fabrication of the truss bridge.

CHAPTER 2 LITERATURE

In this literature the types of bridges, commonly used construction materials and important design theories are discussed.

2.1 Types of bridges:

Bridges are structures that span and provide a passage over a road, railway, river, valley, or any obstacles within a short time and safe way. Construction of bridges started early in the first century B.C. and it has been developing new solutions from time to time. The main aim of an engineering design discipline is to make the bridges economical and safe for users in their entire lifetime, hence bridges must be designed for long lifetime service, normally, 50 to 100 years. There are several types of bridge designs, each with advantages and disadvantages. The design of bridges mainly depends on the span, function of the bridge, available construction material and economy. Some of the common bridges are Arc bridges, floating bridges, suspension bridges, beam bridges and truss bridges. A truss bridge is specifically to be discussed in this thesis.



a. Arch bridge



b. Suspension/cable bridge



c. Beam bridge



d. Truss bridge

Figure 1: Types of bridges. a) Arch bridge. b) Suspension/cable c) Beam bridge. d) Truss bridge

Arch bridge:

An arch bridge is a typical structurally curved or semicircular shaped bridge. Most of the curved structure is designed to be at the middle of the span to distribute the load pass to the supports. Arch bridges are one of the oldest and strongest structural designs, commonly built with stones before steel and concrete were introduced. Gradually, wood, concrete, and steel metals were used to build arch bridges. For centuries, Arch bridges have been a primary choose for engineers

due to their strength, durability of building materials and their environmentally adapted appearance. The drawbacks of this type of bridge are the high construction cost, limited clearance, design flexibility and expensive maintenance.

Suspension/cable-stayed:

The suspension and cable-stayed bridges are some of the modern long span bridge structures. Suspension and cable-stayed bridges have one or more towers that can support the bridge deck and the tension cables. The cables are usually subject to tension forces. The primary advantage of cable-stayed bridges is their ability to span longer distances than traditional suspension bridges. Furthermore, these bridges are cost-effective in construction and maintenance due to their less material requirement and the cables are easily accessible for inspection and maintenance. Few disadvantages of Cable-stayed bridge are their high design and construction cost due to the complex structural design requirements and the demand of specialized equipment and skills during construction. Moreover, cable-stayed bridges are highly exposed to vertical wind damage due to the cables are designed only for tension. Due to susceptibility to corrosion. These bridges need a lifetime inspection and maintenance.

Beam Bridges:

The simplicity of beam bridges offers several advantages that make them a popular choice for relatively short span bridges. A significant advantage of beam bridges is that they are often easy to design and construct, which results in a cost-effective construction option. Due to their simple design, beam bridges are often easy to inspect and maintain. (Gao et al 2020)

Truss bridge:

A truss bridge is one of the common bridge structures in modern times. Truss bridges are constructed with several members joined together to form a triangular rigid structure. A typical truss bridge contains pin joined vertical, horizontal, and diagonal members. The members of the truss bridges are subjected to axial force leading to compression or tension stress. The triangular structure truss bridges are strong and have a high capability to withstand heavy loads. Truss bridges are suitable for long-span bridges and are cost-effective to build. The truss members are joined together by welding, bolting to a gusset plate. Some of the main parts of a truss bridge are top and bottom chords, stringers, lateral bracing, and floor beams. In this thesis a Warren truss bridge is tested and analyzed experimentally and with FEM using SAP2000.

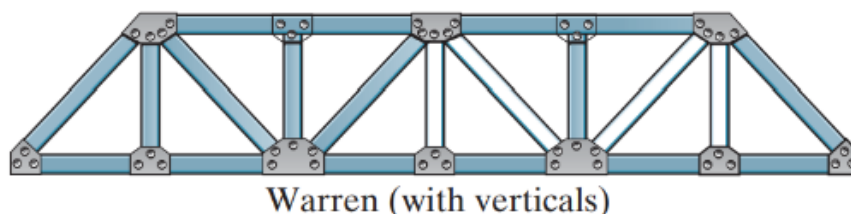

Figure 2: Warren truss (with verticals)

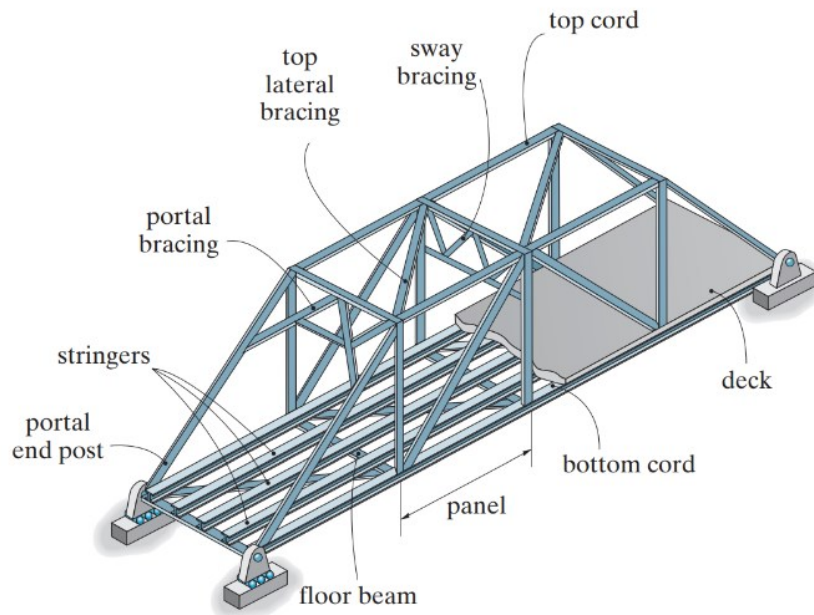

Figure 3: Truss bridge members (Hibbeler structural analysis chapter 3. page:82)

The top and bottom cords are the main parts of a truss subjected to an axial compression or tension force to resist the bending moment due to the load. The upper chord is subjected for compression, and it is essential to be designed against buckling. That unpredictable out-of-plane buckling of the upper chord might cause bridge damages before the whole bridge reaches its vertical bearing capacity. Therefore, the stability of the upper chord is crucial to truss bridges and calculating the critical length of the upper chord is likely to be critical in the structural design. In the upper chord joint, rotation and buckling are restrained. Because on the upper chord truss bridge are laterally constrained by vertical, horizontal, and diagonal web members at the joints. Deck is one part of the truss bridge which lies above the structural parts of the lower chord. The load from the deck is transferred to the stringer which is often subjected to axial tension load.

Stringers are longitudinal beams located under the deck parallel to the traffic direction. They carry the deck load and transmit the load to the floor beam. Floor beams are designed to carry the load from the stringers and distribute the load to the bottom cords of the main trusses. The top and bottom cords of a truss bridge are restrained by web cords. The web members include the vertical member and diagonals. The vertical members are subjected to the shear force and provide a stiffness against buckling, while the diagonals are forming a strong triangular form to make the structure stable. The diagonals are subjected to tension and compression forces, and they are effective when designed to form 45-60 degrees to the horizontal members. Another important part of a truss bridge is the joints that intersect the truss members. Joints are categorized into pinned or a hinge joint and gusset plate joint. The last mentioned connecting more common for connecting two or more truss members. A truss joint is theoretically assumed to be pin joint which means it can only resist an axial force. Truss connections are actually

restrained to resist axial, rotational and bending movements. (Weiwei & Yoda. 2017), (Wen & Yue. 2020).

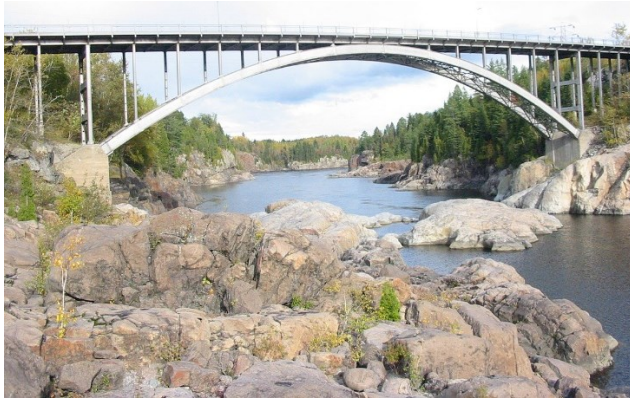

Figure 4: Gusset plate connection

2.2 Aluminum bridges

The La Barre Bridge in Quebec, Canada, which is the first aluminum pedestrian bridge in the world. The Centennial Bridge in Miramichi, New Brunswick, Canada, which is a vehicular bridge made entirely of aluminum. The Aluminum River Bridge in Alaska, USA, is a lightweight aluminum pedestrian bridge that spans the Kenai River. Overall, aluminum bridges offer a range of benefits over traditional bridge materials, particularly in situations where weight and corrosion are critical considerations.

The Arvida bridge (Figure 5 a) in Canada was built in 1950 which located Rue du Pont across a branch of the Saguenay River just southwest of the Shipshaw II Hydroelectric Power Station. The bridge was designed by engineer Pierre Fortin and was constructed by Dominion Bridge Company. It has a length of 154m, and the main span is a parabolic arch with a span-length of 91.5m. The construction of the bridge was a significant engineering achievement at the time, as the Saguenay River is subject to strong winds and heavy ice flows during the winter months. The bridge was designed to withstand these conditions and has been an important transportation link in the region for many years. Today, the Arvida Bridge remains an important landmark and is listed as a historic site by the Canadian government. It continues to serve as a major transportation route for vehicles and pedestrians, connecting the communities of Saguenay and surrounding areas. The Arvida bridge is the first aluminum bridge constructed entirely of aluminum. The weight of the structure is 163 tons, which is half less than the weight of steel bridge in comparable (Mezei, 1985).



(a) Arvida bridge in Canada



(b) Forsmo bridge in Norway

Figure 5: Aluminum bridges in Norway and Canada

The Forsmo Bridge is a suspension bridge located in the municipality of Grong in Nord-Trøndelag County, Norway. It spans the Namsen River and connects the villages of Harran and Grongstad. The bridge was completed in 1996 and is 660 meters long, with a main span of 400 meters. The Forsmo Bridge was designed by the Norwegian engineering firm Aas-Jacobsen and is registered for being one of the longest suspension bridges in Norway. It was also the first bridge in the country to use aluminum for the deck and main cables. The aluminum was chosen for its light weight and durability, which made it an ideal material for use in the bridge's construction. The bridge has become a popular tourist attraction in the region, as it offers spectacular views of the Namsen River and the surrounding landscape. It is also an important transportation link for the local community, providing a vital connection between the villages of Harran and Grongstad. Overall, the Forsmo Bridge is a significant engineering achievement that showcases the use of innovative materials in bridge construction. Its lightweight design and use of aluminum have made it a durable and reliable structure that serves the needs of the local community while also attracting visitors from around the world (Enevoldsen et al., 2002).

2.3 *Structural Materials*

Steel and concrete are the common and well adapted types of construction materials. New construction materials have been developed and are still developing nowadays with the help of new technology. In human history, wood, stone, iron and bronze were some of the oldest building- and tool materials used by human beings. The stone, iron and bronze ages were the time where historical progress in construction materials was achieved. New tools, machines, and industries developed. This development has changed the principle of design and construction method of large and complex structures. The construction industry has become a time and material effective construction industry with the help of machines. They become capable of constructing long span and complex bridges using newer and better materials. Early used materials such as wood, stones and iron were relatively weak and are replaced by structural steel and reinforced concrete. Woods and stones are the cheapest and oldest used materials still used in construction of bridges and other engineering structures. (Ozyhar et al. 2012), (Arun et al.. 2021). Concrete is a widely used construction material that can be used in the construction of foundation, beam bridges, towers, and suspension bridges. Concrete is a composite material made of cement, aggregates, reinforcement steel, admixture, and sand. Concrete has namely

high compression resistance yield strength, high durability, fire resistance and good workability forming various shapes. Moreover, it has lower maintenance costs and is suitable for heavy-duty structures in a harsh environments. (USA TRB NCHRP. 2004)

2.3.1 Structural Steel

Steel is a widely used construction material, made of iron and alloying elements such as carbon, manganese, chromium, vanadium, silicon, and others. Alloys are added to iron during manufacturing in a controlled manner to reach a special mechanical composition. Carbon is the largest alloying element in steel ranging from 0.2 -2.1%. Depending on the chemical composition and Properties steel can be divided into various groups. Structural steel, tool steel and stainless steel are used for construction of engineering structures, manufacturing- tools and machines and food and oil processing industries, respectively. (Warrian. 2016)

The mechanical property of structural steel depends on its chemical composition, manufacturing process and additional treatments, such as heat treatment, hot and cold rolling. Structural steel has a variety of yield grades, and its structural name is associated to its yield strength, such as S235, S275, S355 and S450. Generally, structural steels are classified into low, medium, and high strength alloy steels based on their strength and content of carbon percent. Although steel is suitable for most structural constructions, its weight to volume ratio is high and engineers are looking to other materials which can reduce the self-weight of the construction. Aluminum has a low weight to volume ratio, and it has been used in the construction of aircraft, building facades, pedestrian bridges, and a few vehicle bridges. In this thesis the truss bridge is constructed from Aluminum, hence the property of this aluminum as construction material is to be discussed.

Table 1: Nominal values of yield strength f_y and ultimate tensile strength f_u for hot rolled structural steel.

Standard and steel grade	Nominal thickness of the element t [mm]			
	t ≤ 40 mm		40 mm < t ≤ 80 mm	
	f_y [N/mm ²]	f_u [N/mm ²]	f_y [N/mm ²]	f_u [N/mm ²]
EN 10025-2				
S 235	235	360	215	360
S 275	275	430	255	410
S 355	355	490 (452)	335	470
S 450	440	550	410	550
EN 10025-3				
S 275 N/NL	275	390	255	370
S 355 N/NL	355	490	335	470
S 420 N/NL	420	520	390	520
S 460 N/NL	460	540	430	540
EN 10025-4				
S 275 M/ML	275	370	255	360
S 355 M/ML	355	470	335	450
S 420 M/ML	420	520	390	500
S 460 M/ML	460	540	430	530
EN 10025-5				
S 235 W	235	360	215	340
S 355 W	355	490 (452)	335	490
EN 10025-6				
S 460 Q/QL/QL1	460	570	440	550

2.3.2 Aluminum as Construction material

Aluminum alloy has been used in bridge construction for more than 70 years. The first aluminum bridge was built in the USA in Pittsburgh's Smithfield Street Bridge. The bridge was first made of steel and wood and replaced by aluminum later (Das et al., n.d.). The Norwegian Public Road Administration (NPRA) is working with aluminum alloy as a construction material for bridge. This helps reduce the cost of road construction and maintenance. (Brekke, 2017).

Aluminum is the next commonly used metal after steel. Al is used in various engineering applications including in aerospace, building, automotive, food industries and engineering structures. Al has a high strength to weight ratio, good electrical conductivity, and high corrosion resistance. Pure aluminum is very soft and unsuitable for structural applications. Some alloying elements are added to Aluminum to obtain the mechanical properties required by engineering structures. Depending on the percent of the alloying element and type of treatment, aluminum is subdivided into several series ranging from 1xxx - 7xxx. The strength of the Al series increases as the alloying series gets higher. The selection of aluminum alloy for a truss bridge depends on various factors such as the size of the bridge, the load it will support, and the environment it is exposed (Vargel, 2004).

Table 2: Aluminum Alloys

Series	Major alloying element	Method for strengthening	Yield strength (MPa)	Tensile strength (MPa)
1xxx	No alloy	Cold working	4-24	75-96.5
2xxx	Copper	Cold working + precipitation	11-64	152
3xxx	Manganese	Cold working, solid solution, dispersion	110-200	
4xxx	Silicon	Cold working, dispersion		
5xxx	Magnesium	Cold and solid solution	80-180	211
6xxx	Mg and silicon	Cold and precipitation		120-312
7xxx	Zinc, Mg, and Cu	Cold and precipitation		314

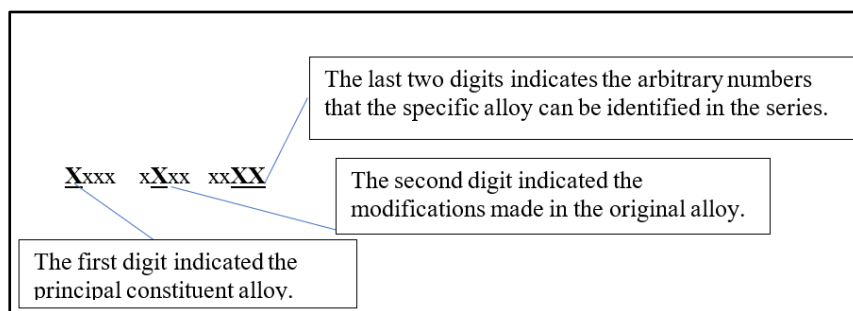

Figure 6: Aluminum Alloy series number descriptions

The 6082 T6 aluminum alloy is commonly used in various industrial and commercial applications. It is known for its high strength and corrosion resistance, making it a suitable choice for structural components in the aerospace, transportation, and construction industries. The "T6" indicates that the alloy has been heat-treated to obtain higher strength and toughness. This heat treatment involves heating the alloy to a specific temperature and then rapidly cooling to produce a fine-grained structure that provides exceptional strength and resistance to fatigue. Alloy 6082 T6 is a wrought alloy processed using mechanical deformation methods such as rolling, extrusion, or forging. This allows the alloy to be shaped into various forms to suit different applications. Alloy 6082 T6 is also known for its excellent corrosion resistance, particularly in marine environments having saltwater and sulfides.

Corrosion is the main reason for maintenance and surface treatment in many industries. The corrosion resistance of an aluminum metal depends on its chemical composition, metallurgical temperature, and the joining method as well as the condition of the service. Corrosion is a slow or rapid deterioration of metals property such as its appearance, its surface aspect, or its mechanical property. The electrochemical reaction of metal and aqueous phase cause corrosion. That takes place by the reduction and oxidation of electrons. That causes the loss of mass of the metal. As Al has indeed a low deterioration rate and higher strength per weight than structural steel, engineers are interested in using aluminum as a structural material. However, aluminum is exposed to galvanic corrosion when it is in contact with least noble metals such as carbon steel with the presence of electrolyte. (Handbook of Corrosion Engineering by Pierre R. Roberge), (Roberge. 2000).

Galvanic Corrosion Risk		Contact Metal																	
		Magnesium and Alloys	Zinc and Alloys	Aluminum and Alloys	Cadmium	Carbon Steels	Cast Iron	Stainless Steel	Lead, Tin, and Alloys	Nickel	Brasses, Nickel-Silvers	Copper	Bronzes, Cupro-Nickels	Nickel Copper Alloys	Nickel-Chrome Alloys, Titanium, Silver, Graphite, Gold, and Platinum				
Corroding Metal	Magnesium and Alloys	Green	Green	Green	Green	Green	Green	Green	Green	Green	Green	Green	Green	Green	Green	Green	Green	Green	
	Zinc and Alloys	Green	Green	Green	Green	Green	Green	Green	Green	Green	Green	Green	Green	Green	Green	Green	Green	Green	Green
	Aluminum and Alloys	Green	Green	Green	Green	Green	Green	Green	Green	Green	Green	Green	Green	Green	Green	Green	Green	Green	Green
	Cadmium	Green	Green	Green	Green	Green	Green	Green	Green	Green	Green	Green	Green	Green	Green	Green	Green	Green	Green
	Carbon Steel	Green	Green	Green	Green	Green	Green	Green	Green	Green	Green	Green	Green	Green	Green	Green	Green	Green	Green
	Cast Iron	Green	Green	Green	Green	Green	Green	Green	Green	Green	Green	Green	Green	Green	Green	Green	Green	Green	Green
	Stainless Steels	Green	Green	Green	Green	Green	Green	Green	Green	Green	Green	Green	Green	Green	Green	Green	Green	Green	Green
	Lead, Tin, and Alloys	Green	Green	Green	Green	Green	Green	Green	Green	Green	Green	Green	Green	Green	Green	Green	Green	Green	Green
	Nickel	Green	Green	Green	Green	Green	Green	Green	Green	Green	Green	Green	Green	Green	Green	Green	Green	Green	Green
	Brasses, Nickel-Silvers	Green	Green	Green	Green	Green	Green	Green	Green	Green	Green	Green	Green	Green	Green	Green	Green	Green	Green
	Copper	Green	Green	Green	Green	Green	Green	Green	Green	Green	Green	Green	Green	Green	Green	Green	Green	Green	Green
	Bronzes, Cupro-Nickels	Green	Green	Green	Green	Green	Green	Green	Green	Green	Green	Green	Green	Green	Green	Green	Green	Green	Green
	Nickel Copper Alloys	Green	Green	Green	Green	Green	Green	Green	Green	Green	Green	Green	Green	Green	Green	Green	Green	Green	Green
	Nickel-Chrome Alloys, Titanium, Silver, Graphite, Gold, and Platinum	Green	Green	Green	Green	Green	Green	Green	Green	Green	Green	Green	Green	Green	Green	Green	Green	Green	Green

Figure 7: Galvanic –reaction chart, where green represents lower corrosion risk and red high corrosion risk. Ref (www.grabbepro.com)

Table 3 Material properties of structural steel Vs Aluminum (Eurocode 3 - Design of Steel Structures - Part 1-5 Plated, n.d.) and from table3.2c (EN 1999-1-1:2007+A1:2009, 2009)

Description	Hot rolled steel S275 (EN10025-2)	Aluminum (6082 T6)
Density	7850 kg/m ³	2700 kg/m ³
Nominal thickness, t	≤ 40mm	≤ 5mm
Yield strength, f _y	275 MPa	250 MPa
Ultimate strength, f _u	430 MPa	290 MPa
Modulus of Elasticity (E)	210 GPa	70 GPa
Corrosion resistance	High corrosion rate	-Low corrosion rate. -corrosion risk in contact with noble metal
Lightness	Heavy	Light in weight
Thermal conductivity	Low	Generally, it's a good heat conductor
Recycling	Recyclable, but demanding	Easier to recycle
Malleability	Hard	Excellent

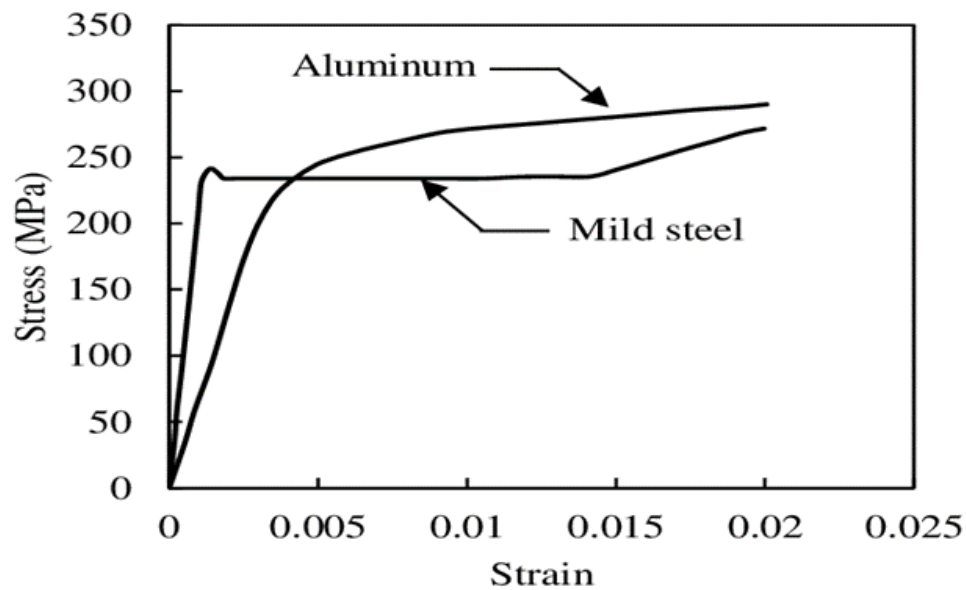

Figure 8 Strain Stress Aluminum Vs Steel

Table 4 Aluminum 6082-T6 Vs 1050A H14 chemical composition and yield strength (Aluminum 6082-T6, n.d.)

Alloys elements in [%]		
Description	6082-T6	1050A H14, 1mm thick
Yield strength [MPa]	250	95/112
Aluminum [%]	95.2 – 98.3	99.51
Chromium. Cr	<=0.25	0.001
Copper. Cu	<=0.10	0.004
Iron. Fe	<=0.50	0.316
Magnesium. Mg	0.6 – 1.2	0.002
Manganese. Mn	0.4- 1.0	0.005
Silicon. Si	0.7-1.3	0.109
Titanium. Ti	<=0.10	0.016
Zinc. Zn	<=0.20	0.002
Lead, Pb		0.002
Other	<=0.15	-

2.4 *Design theory*

Modern truss bridges are designed with well-advanced technology in consideration of structural integrity, materials selection, and geometric configuration. The truss bridge design is optimized for efficiency, safety, and cost-effectiveness, while adhering to engineering standards and regulations. The truss bridge is a type of bridge structure consisting of interconnected triangular units called truss members. These trusses efficiently distribute loads and provide excellent stability and rigidity. The design process involves selecting appropriate materials, determining geometric configurations, analyzing structural forces, and ensuring overall safety. During designing of bridges allowable stress design is one of the most factors that an engineer must calculate and analyze properly. This means the maximum stress in a structure is always smaller than an allowable stress in the bridge (Lin & Yoda, 2017a). The design objectives for the truss bridge follow several key aspects. Structural integrity importance, ensuring that the bridge can support required loads while maintaining stability and integrity under various conditions, including dynamic loads, temperature variations, and environmental factors. The bridge design must have sufficient strength to withstand the maximum required loads, including live loads (such as vehicular traffic), dead loads (bridge self-weight), and environmental loads (wind, snow, etc.). The design aims to optimize material usage and minimize construction costs without compromising safety or structural integrity.

The choice of materials is crucial in achieving the design objectives. Common materials for truss bridges include steel, concrete, and timber. Steel offers high strength-to-weight ratio, durability, and flexibility, making it a popular choice for truss bridges. The material selection also considers factors such as corrosion resistance, maintenance requirements, and cost-effectiveness. We are going to use Alu metal as a construction material. The geometric configuration of the truss bridge influences its structural behavior and visual attractiveness. The span length, height, and width are determined based on the site conditions, required loads, and architectural considerations. The selection of the truss pattern (such as Pratt, Warren, or Howe) depends on factors like load distribution, ease of construction, and architectural preferences. Structural analysis is performed to assess the bridge's response to required loads. This analysis includes calculations for internal forces (tension and compression) in the truss members, deflection limits, stability against lateral forces.

2.4.1 *Loads and load distribution in bridges.*

Generally, bridges are designed to carry dynamic and static loads subjected to the bridge structure safely. These loads are in the form of various types of forces caused by vibration, accidental collision and accelerations due to the vehicles and their surrounding environment. These loads are classified as dead loads, live loads (static and dynamic), environmental loads (temperature, wind, snow load) and accidental loads. Dead load includes the weight of all the structural and non-structural elements of the bridge, and other services such as electrical and plumbing. Usually, the dead load is less than the live load in short-span bridges, whereas the dead load is heavier than the live load in long-Span bridges. So as the span becomes longer, it should be designed well to reduce the dead load on the bridge. Reducing the self-weight of a bridge without affecting its strength significantly can then increase the live load capacity of the

bridge. Hence, engineers today are looking for materials with high strength to weight ratio. Among others, Aluminum with its 2.7 g/cc density and relatively high strength is facing interest by structural and material engineers. (Lin & Yoda. 2017b).

Table 5: Specific Weight of Different Materials

	Material	Unit Weight (KN/m³)
1	Steel	77
2	Cast Iron	71
3	Aluminum	27.5
4	Concrete	23
5	Wood	8
6	Asphalt	22.5

Live load is the weight of the vehicles and other moving loads that will be subjected to the bridge during its service time. Factors such as the weight of the vehicles, traffic volume and the combination of diverse weight vehicles are important to consider during analyzing the expected live load. Additionally, the number of axles, the span between the axles and the maximum load capacity of the vehicle must be considered to decide the worst-case scenario for the live load. In some cases, it may also be important to consider the transportation of heavy equipment and military vehicles, as these can have a significant impact on the bridge structure. Moreover, environmental loads such as winds, waves, snow, earthquake, and other external factors are important to consider in designing. However, these environmental loads are not considered in this thesis.

2.4.2 Classification of cross-section

The cross section of a material has generally a significant impact on the strength and design of a structure. Some cross sections are more subjected to buckling than others. Therefore, the classification of a cross section is used to identify the class of the cross section and hence to avoid local buckling and define its appropriate design resistance. The method of cross-sectional classification of Al is explained in Euro code 9 (EN 1999-1-1:2007+A1:2009, 2009). Some of the common cross-sections used in truss bridge design are I- section, T-section, Channel-section, rectangular hollow section, circular-section, and angle section. According to Euro code 9 design of aluminum, the cross-section is divided into 4 classes of cross-sections. The role of cross-section is to identify the extent to which the resistance and rotation capacity of cross-section is limited by its local buckling resistance.

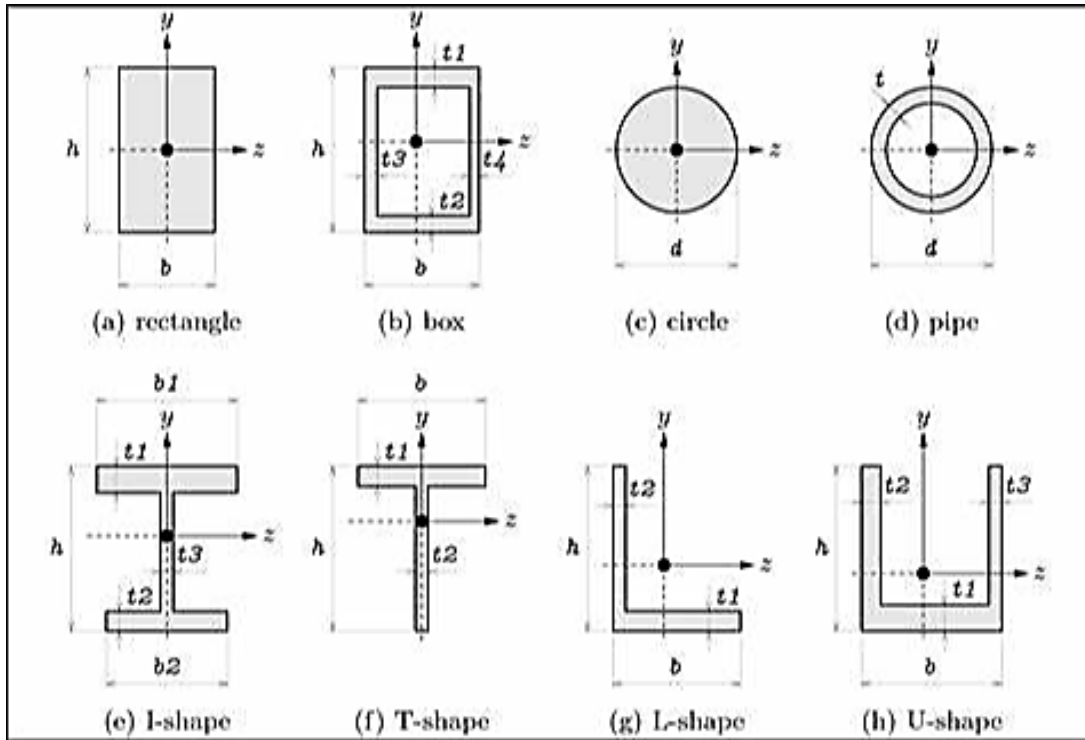

Figure 5: Different Aluminum cross-section

Class 1 cross-sections are those which can form or develop full plastic resistance with full plastic deformation before buckling occurs. Class 2 cross-sections are those which can form or develop full plastic resistance but unlike class 1 it has limited deformation and local buckling can occur. Moreover, the stress in the extreme compression part of a class 3 cross-section can reach its proof strength, but local buckling is likely to prevent development of the full plastic moment resistance. Class 3 cross-sections must be checked for local buckling before proceeding in design. In the last class, class 4 cross-sections the local buckling will occur before the expected proof stress in one or more parts of the cross-section (EN 1999-1-1:2007+A1:2009, 2009).

CHAPTER 3 DESIGN AND FABRICATION OF ALUMINUM TRUSS BRIDGE MODEL

In this section the predesign and fabrication of a prototype and the final truss bridge model is discussed. The truss bridge associated with this thesis is a 38.5m span warren truss bridge with verticals, proposed to use aluminum as a building material. The fabricated experimental and FE model truss bridge, the actual bridge is scaled down to 3000x500x500mm. The team has prepared a prototype model of the truss bridge with a size of 1500 x250x250mm from 25x1mm thick aluminum sheet metal folded to form L-section. After investigating the prototype model, the final truss bridge model was then decided to be fabricated 3000x500x500mm, built with angle cross-section of 15x10x1mm and 12.5x12.5x1mm for the cords and webs respectively. The model was prepared from aluminum sheet metal of grade 1050A, and detail preparation procedures are explained below.

3.1 Predesign of the Al truss bridge

There has been prepared a prototype of the truss bridge with a size of 1500 x250x250 mm (Figure 9) from thickness of 1mm aluminum sheet metal folded into L-section for the upper and lower cord and flat 1mm aluminum for the rest of the members.

During the fabrication of the prototype truss bridge, our teams learned various practical challenges and gained valuable experiences. These experiences have led to a more realistic understanding of the stiffness requirements for the final model. One of the most important observations made was that the cross-sectional area of the members in the initial or prototype truss bridge design are greater than what was necessary to achieve the required stiffness. Furthermore, observation is, that the length of the trucks is closely the same as the length of the prototype truss bridge and this results that there will be an obstacle to make different load cases. Considering the length of the truck used, it became noticed that a longer span for the truss bridge is suggested.



Figure 9: Pre -experimental model design 1500x250x250mm and its cross-sections

3.2 Design of Al Truss bridge Model

In the first step of the design process the structural dimensions of the truss bridge are determined. In this phase, various parameters such as the load requirements, and material properties are considered to ensure structural stability and safety. The design process is first obtained by theoretical calculations ensuring all load resistance requirements, and the design model is optimized using FEM SAP2000. This gives an early overview of how the final truss bridge model to be to have a measurable experimental strain by the stain gauge. The preparation of truss bridge model in SAP2000 is described in detail in chapter 5. The final truss model is then designed to be 3000x500x500mm with L-cross section for all members. Once the design is finalized, the next step involves the fabrication of the truss members. In this project, 1mm thickness of aluminum sheet metal of series 1050A, folded into “L” angle-section is used. After calculating the minimum area required to carry the maximum design load, a cross-section of 15x10mm for the upper and lower cords and 12.5x12.5mm for the web members is designed.

Unequal angle-section with a flange of 15mm is selected for the top and bottom cords due to practical assumptions and to avoid stress concentration around the joint holes. Since all the members are connected to the upper and bottom cords, selecting a larger vertical dimension provides enough surface area for joining the members together.



Figure 10: Flatt Al sheet metal before folded.

3.3 Fabrication of the Final Al Truss bridge

Truss bridge model fabrication involves several critical steps that must be executed with precision and accuracy to ensure structural integrity and safety. This section outlines the key steps involved in the fabrication process of a truss bridge made of aluminum metal. Flat 1mm thickness Al sheet metal is cut with the cross-section area of 25mm² by metal plate cutter machine, then it folded in to “L” shape. The Plate folder machine is used to fold the plates into “L” angel. The L-shaped sections are then drilled to create holes for connecting the members. The drilling process is executed with accuracy to ensure proper alignment and connection of the truss members. The bottom cord part of the truss bridge was first cut 3meter long and 25mm width Al sheet metal and that was folded into “L” section. The top cord was the same as the bottom cord, but the length of the top cord is 2 meters. The dimension of the cross-section for both cords is 15x10mm (Figure 9b). Another flat sheet metal, measuring 707mm in length and 25mm in width is being cut to form “L” shape angle End-post with a cross-sectional dimension of 12.5x12.5mm. The web member, the floor beam and bracing members also have 500mm

length and 25mm width which folded to equal cross-section of 12.5x12.5mm. Moreover, a stringer is fabricated to create a path for the truck. The stringers are located at the same distance from each side of the truss; hence they distributed the loads equally between both sides of the truss. The stringer is 3 meters long and 10mm width. In order to simplify the fabrication and installation process of the stringer, it has been made to cut it into 1.5meter length and 10mm width of sheet metal Al and folded by 1mm on both sides. This folding helps to guide the truck along the path.



(i) Stringer



(ii) Truss bridge

Figure 11: Fabricated Al truss bridge

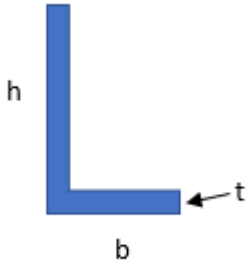

Unequal angle-section
 $h=15, b=10$ and $t=1\text{mm}$

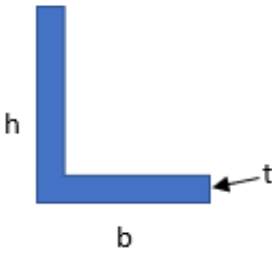

Equal angle-section
 $h=12.5, b=12.5$ and $t=1\text{mm}$

Figure 12: Angle sections used in the truss fabrication.

The connection of truss member bridge is pin connection. Most of the truss bridges are joined with Gusset plate connection (Figure 4), but in this thesis modeling 3mm in diameter and 20mm long screw is used to connect the members together. One screw at each joint is used due to the cross section of the L-section was small and the assumed load was relatively small. Joint design is not included in this thesis.

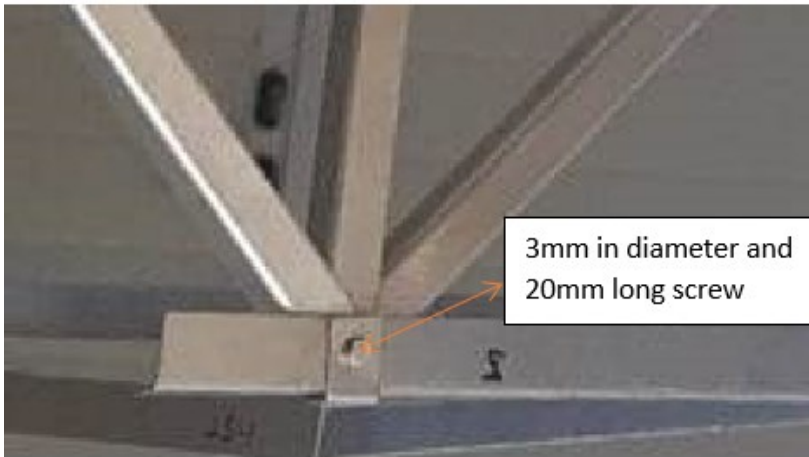

Figure 13: Pin joint, hole diameter 3.3mm and screw M3 20mm length

The final step in the fabrication process is the assembly of the truss bridge. The individual truss members are accurately aligned and connected to form the complete truss bridge. The screw is used to secure the connections between the truss elements. The assembly process is carried out with precision to ensure the structural stability and safety of the truss bridge. Finally, quality control checks are conducted to ensure that the bridge meets the design specifications. In conclusion, the fabrication of a truss bridge using aluminum metal involves a series of critical steps that must be carried out with precision and accuracy. By following the design specifications, cutting, and shaping the aluminum plates, folding, and drilling, joining the truss members, surface treating the aluminum surface, and finally assembling and quality control checking the bridge stability.



Figure 14: Al Truss bridge

To construct this bridge various instruments, plate cutter and plate folder machine are used. A Plate Shearing Machine with a 12mm cutter is a type of machine used for cutting metal plates to a specific size and shape. The machine consists of a fixed lower blade and a moving upper blade that are designed to shear through the metal when brought together. The 12mm cutter specification suggests that this machine can cut through metal plates that are up to 12mm thick. The machine can be operated manually or hydraulically, depending on the size and complexity of the job. Guillotine Plate Shearing Machines are commonly used in the manufacturing, metalworking, and construction industries for tasks such as cutting metal plates for structural components, sheet metal fabrication, and metal recycling. They offer high precision, efficiency, and accuracy, making them an essential tool for cutting metal plates to the required dimensions and shapes (Kaczmarczyk, 2019).

A plate folder machine, also known as a sheet metal folding machine, is a machine used to bend and shape metal sheets and plates into various angles and shapes. The machine consists of a clamp, a back gauge, and a bending beam, which work together to apply force and bend the metal sheet. The function of a plate folder machine is to create precise and accurate bends in metal plates, which is essential for various industries such as metal fabrication, manufacturing, and construction. The machine can be used to bend metal plates of various thicknesses and widths, ranging from a few millimeters to 3meters long. These machines were primarily used in the automobile and construction industries to bend metal sheets into various shapes and angles. Plate folder machines have become more advanced, with the introduction of hydraulic and computerized control systems that allow for greater precision and control in the bending process. Modern plate folder machines can also be equipped with automated back gauges and sheet support systems, which improve efficiency and accuracy in the bending process. Today, plate folder machines are widely used in industries such as metalworking, manufacturing, and construction for bending metal plates to a specific angle and shape. They offer high precision and accuracy in the bending process, making them an essential tool for various industries that require precise and accurate metal bending.



a) Shearing machine



b) Folder machine

Figure 15: A Guillotine Plate Shearing Machine with a 12mm and 14B Plate folder machine.

CHAPTER 4 THEORETICAL ANALYSIS OF A TRUSS BRIDGE

The truss bridge design theory, assumptions and structural analysis of the aluminum truss bridge is discussed in this chapter.

4.1 *Design assumptions*

To design members of a truss bridge. The force in each member should be determined and the members should be idealized. All loads are assumed to be applied at the joints and hence the members are exposed to an axial tensile or compression forces. All members are joined by pins and their joining centerlines are concurrent at a point. By introducing this assumption. the secondary stress in the members is excluded from our analysis. Moreover, the determinacy and stability of the truss bridge is determined. Internal and external stability where a truss structure $b+r < 2j$ will be classified as unstable. A truss is externally unstable if all its reaction forces are concurrent or parallel.

$$b+r = 2j$$

Equation 1

4.2 *Truss bridge design using ultimate limit state (ULS)*

A corresponding material property to 1050A was taken from EN. AW 5005A H12/H22/H32. (EN 1999-1-1:2007+A1:2009, 2009)

$$F_y = F_0 = 95 \text{ N/mm}^2$$

$$F_u = 125 \text{ N/mm}^2$$

4.2.1 *Determine the design axial load (N_{Ed})*

Axial load is a force acting along the axis or centerpiece of a structure. This type of load can be from pressure or compression. If the action of the load is to increase the length, then the member is in tension. If the applied load tends to shorten the member, then the member is in compression. Using load combination, that is the dead load and the load of vehicle with its maximum load capacity (live load) is going to obtain design load of the truss by (Equation 2).

$$N_{ed} = 1.35(\text{dead load}) + 1.5(\text{Imposed load})$$

Equation 2

A total length of 11.7 m with a cross-sectional area of 24 and $2.7 \times 10^{-6} \text{ kg/mm}^3$ of aluminum material is used for constructing the single truss of the bridge. From this a dead load of 7.46N is calculated. Moreover, the truss bridge is assumed to be subjected to a total live load of 250N. Each side truss of the bridge is then loaded with 125N.

$$N_{ed} = 1.35(7.46) + 1.5*(125).$$

$$\underline{N_{ed} = 197,58\text{N}}$$

4.2.2 Determine the cross section.

After we find the design load capacity, it is necessary to determine the cross-section area of the members. According to the design load and the area we obtained, we can design our truss members.

$A \geq N_{ed} / \chi F_y$. Guess “ χ ” from 0.3-05. If the cross-section is not suitable. “ χ ” can calculate from (EN 1999-1-1:2007+A1:2009, 2009)

$$A \geq \frac{N_{Ed}}{\chi f_y}$$

Equation 3

$$A \geq 20.80$$

$$\chi = 0.1$$

$$A \geq 20.80 \text{mm}^2.$$

The selected area is 24mm².

4.2.3 Class classifications of the cross-section

The classification of a cross section is used to avoid local buckling and define its appropriate design resistance. Class classification is one of the designing parameters which should be calculated or identified.

Check class classification for the “L” angle member. We have cross-section of 15x10x1mm.

$$\beta = b/t$$

Equation 4

From (EN 1999-1-1:2007+A1:2009, 2009) Part 1-1 General. 6.1.4.3 slenderness parameter equation 6.1

$$\beta = 10/1 = 10 \text{ and } 15/1 = 15$$

if $\beta_3 < \beta$. then the cross-section is class 4. To find the value of β_3 we must identify the class of the material from “Ref: (EN 1999-1-1:2007+A1:2009, 2009) for Alu-structures page-36. table 3.2a” and the formula from page 74. Construction material is EN-AW 5005A H12/H22/H32 ≤ 12.5 .

The material is classified as class B. without welds in class “B” and according to the classification of the material the value of β_3 from table 6.2 slenderness parameters in Eurocode 9 (EN 1999-1-1:2007+A1:2009, 2009) shown on Figure 16 and Figure 17.

$$\beta_3 < \beta$$

Equation 5

(1) The classification of parts of cross-sections is linked to the values of the slenderness parameter β as follows:

Parts in beams	Parts in struts
$\beta \leq \beta_1$: class 1	$\beta \leq \beta_2$: class 1 or 2
$\beta_1 < \beta \leq \beta_2$: class 2	$\beta_2 < \beta \leq \beta_3$: class 3
$\beta_2 < \beta \leq \beta_3$: class 3	$\beta_3 < \beta$: class 4
$\beta_3 < \beta$: class 4	

Figure 16: Slenderness parameter for classification of parts of cross-sections from (EN 1999-1-1:2007+A1:2009, 2009)

Material classification according to Table 3.2	Internal part			Outstand part		
	β_1/ε	β_2/ε	β_3/ε	β_1/ε	β_2/ε	β_3/ε
Class A, without welds	11	16	22	3	4,5	6
Class A, with welds	9	13	18	2,5	4	5
Class B, without welds	13	16,5	18	3,5	4,5	5
Class B, with welds	10	13,5	15	3	3,5	4
$\varepsilon = \sqrt{250/f_0}$, f_0 in N/mm ²						

Figure 17: Slenderness parameters from table 6.2 (EN 1999-1-1:2007+A1:2009, 2009)

$$\varepsilon = \sqrt{\frac{250}{f_0}}$$

Equation 6

$$\varepsilon = 1.62$$

The value of β_3 from the above table class B without welds $\beta_3/\varepsilon = 5$.

Then obtained: $\beta_3 = 8.10$.

$$\beta_3 < \beta.$$

8.10 < 10 _____ when b=10 the cross-section is then classified as class 4.

8.10 < 15 _____ when b=15 the cross-section is then classified as class 4.

The values are satisfied for this equation and the overall cross section is class 4. "Ref: en.1999.1.1.2007 Eurocode 9 Design of aluminum structures - Part 1-1 General.

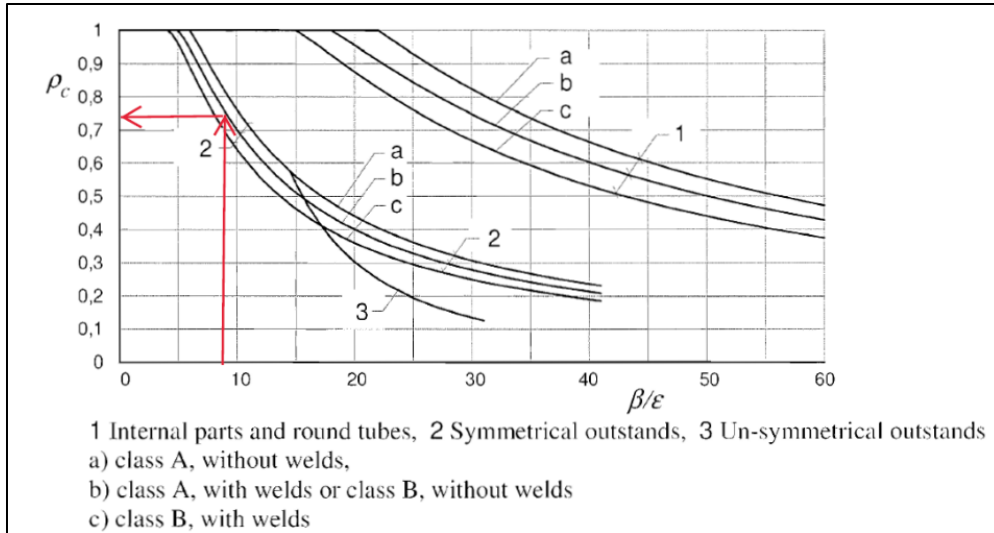

Figure 18: Buckling reduction factor ρ_c for class B without welds, symmetrical outstands from figure 6.5 (EN 1999-1-1:2007+A1:2009, 2009)

4.2.4 Determining cross-sectional design compression resistance $N_{c,Rd}$

In this determination maximum designed load resistance that applied on the truss bridge is calculated by (Equation 7). As the member is class 4, A_{eff} is required and from Euro code 9 we find A_{eff} .

$$N_{c,Rd} = \frac{A_{eff} f_y}{\gamma_{M_1}}$$

Equation 7

$A = 24 \text{ mm}^2$, $f_y = 95 \text{ N/mm}^2$, partial factor property $\gamma_{M_1} = 1.10$.

$$A_{eff} = \rho_c A_c$$

Equation 8

To calculate the effective area, finding the reduction factor (ρ_c)

$$\rho_c = \frac{c_1}{(\beta/\epsilon)} - \frac{c_2}{\left(\frac{\beta}{\epsilon}\right)^2}$$

Equation 9

Constants C_1 and C_2 in expressions for ρ_c				
Material classification according to Table 3.2	Internal part		Outstand part	
	C_1	C_2	C_1	C_2
Class A, without welds	32	220	10	24
Class A, with welds	29	198	9	20
Class B, without welds	29	198	9	20
Class B, with welds	25	150	8	16

Figure: 19 Constants C from figure 6.3 in (EN 1999-1-1:2007+A1:2009, 2009)

$$\rho_{c15} = 0.74. \quad \rho_{c10} = 0.93$$

then. $\rho_c = \min(0.7, 0.93) \Rightarrow 0.74$ is selected as buckling factor.

$$A_{eff} = \rho_c * AC$$

$$A_{eff} = 0.74 * 24 = \underline{\underline{17.76 \text{ mm}^2}}$$

$$N_{c, Rd} = (17.76 * 95 / (1.10)) = \underline{\underline{1533.82 \text{ N}}}$$

4.2.5 Check the compression design load is greater than design load.

Checking the critical load design should be greater than the applied load. This mechanism ensure that our member is suitable to carry the applied load.

$$\text{Check } N_{c, Rd} \geq N_{Ed}$$

Equation 10

$$\underline{\underline{1533.82 \text{ N} > 221.25 \text{ N} \text{ ----- ok}}}$$

4.2.6 Find the buckling design load $N_{b, Rd}$

Buckling is a sudden lateral failure of an axially loaded member in compression. The compression members must be loaded less than the failure load capacity.

$$N_{b, Rd} = \frac{k \chi A_{eff} f_0}{\gamma M_1}$$

Equation 11

$$\chi_{bar} = \sqrt{\frac{A_{eff} * f_0}{N_{cr}}}$$

Equation 12

$$N_{cr} = \frac{\pi^2 EI}{(L_{cr})^2}$$

Equation 13

where: - E- is the Elastic modulus of the material. I- is the moments of inertia. L- is the length of the member.

$$L_{cr} = \min(L_1, L_2 \dots)$$

Equation 14

$$L_{cr} = 500 \text{ mm}$$

$$N_{cr} = 1564,06 \text{ N}$$

$$\chi_{bar} = \sqrt{\frac{A_{eff} * f_o}{N_{cr}}} = 1.04$$

Using bar in combination with the diagram in figure 6.11 in EN 1999-1-1:2007. $\chi = 0.55$

Since our material class B is without welds then $k = 1$

$$N_{b.Rd} = \frac{0.55 * 17.76 * 95}{1.1} = 843.60 \text{ N}$$

4.2.7 Design check for buckling.

$$N_{b.Rd} \geq N_{Ed} = 843.60 > 221.25$$

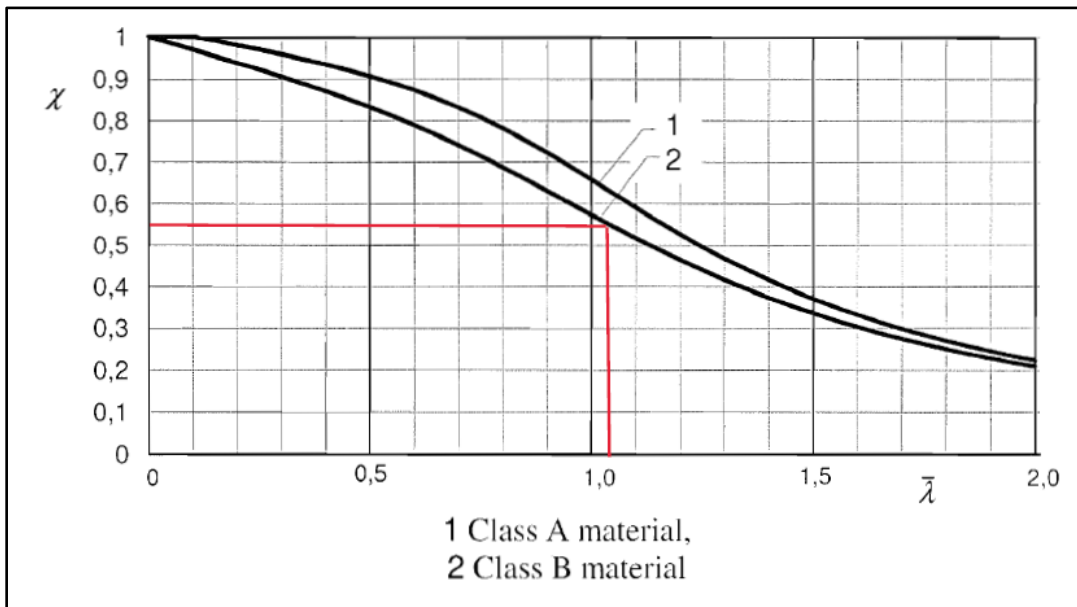

Figure 20: Reduction factor for flexural buckling figure 6.11 (EN 1999-1-1:2007+A1:2009, 2009)

4.2.8 Determine displacement at a specified point:

Using the energy method (Equation 15), the displacement of members at joint will be calculated.

$$\Delta = \sum \frac{nNl}{AE}$$

Equation 15

Where: - 1- is applied virtual load in direction of Δ . Δ - is desired joints displacement caused by real external load. n- is internal virtual force in a truss member caused by external virtual unit load. N- is internal force in a truss member caused by real load. L- is length of each member. A- area of the property and E- is the elastic modulus of the material.

$$U_e = U_i$$

Equation 16

The internal deformation due to virtual force and external forces in each joint is obtained by the principle of virtual energy work (Hibbeler structural analysis). First the determinacy of the structure is determined following: -

Degree of determinacy:

$$m + r - 2j$$

where j is number of joints. m is number of members and r is number of reactions.

$m + r < 2j$ the structure is statically unstable. $m + r = 2j$ the structure is statically determinate.

$m + r > 2j$ the structure is statically indeterminate. The truss bridge in this thesis has 21 members. 3 support reactions and 12 joints. Hence. the degree of determinacy $\Rightarrow 24=24$. the structure is statically determinate.

In our case we are going to consider 7 joints. when unit load is at point_1 = 0mm, point_2 = 500mm, point_3=1000mm, point_4 =1500mm, point_5 = 2000mm. point_6 = 2500mm, point_7 = 3000mm. Due to the symmetry the unit load is located and the forces are calculated joints nr 2, 3 and 4.

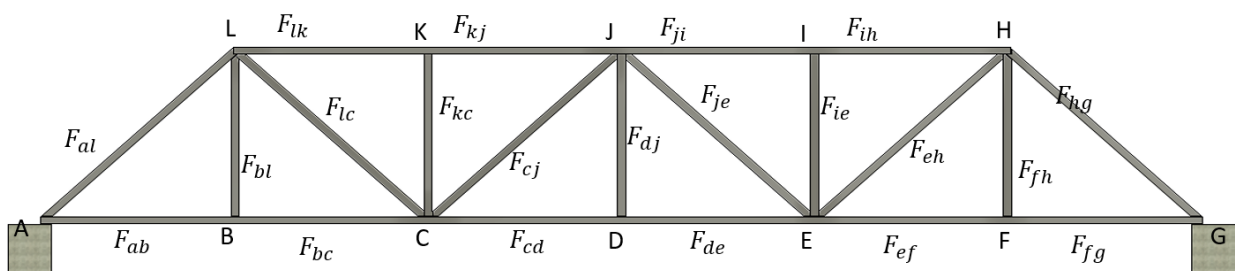

Figure 21: The design truss bridge with all members

The truss bridge is designed to have a pin joint at support A and roller at support G. When x is 0, the load is at support A, when x is 3000mm, the load is at support G. The unit load and the real load has no effect on the members when it is applied directly at the supports.

Influence line

In this problem an influence line for the truss member using the basic method is constructed at member lk, lc, kj, cj and bc and the influence line is used to find the maximum effect of live loading. An influence line is a graphical representation of how a particular load or force on a structure or structural element, such as a beam or a truss member, would influence the response or behavior of that element. Specifically, an influence line shows how a particular force or load would be distributed along the length of the structure or element, and how that distribution of force or load would affect the internal forces. In structural engineering, influence lines are used to help determine the maximum or critical loads that a structure or element can withstand, and to help optimize the design of a structure or element for a given set of loading conditions. Influence lines are typically generated using either analytical or graphical methods. We will show the analytical results in the table and graphical results as well.

Table 6: Influence line at member lk, lc, kj, cj and bc

	At point B	At point C	At point D	At point E	At point F
member lk	-0.67	-1.33	-1.00	-0.67	-0.33
member lc	-0.23	0.94	0.70	0.47	0.23
member kj	-0.67	-1.33	-1.00	-0.67	-0.33
member cj	0.23	0.47	-0.70	-0.47	-0.23
Member bc	0.83	0.67	0.50	0.33	0.17

4.3 Results of theoretical analysis

The results obtained in the calculation are presented below.

Table 7: Results of Theoretical Analysis

Results of Theoretical Analysis	
Name	Results
Design axial load (Ned) Ned	197,58N
Cross-section is "L" angle and area is	24mm ²
Class classification of the member is class	Class 4
Design compression resistance Nc, Rd	1533,82N
Check the compression designed loas is greater than designed load Nc, Rd > Ned	1533.82N > 221,25 N
Buckling design load Nb, Rd	843,60N
Design check for buckling Nb, Rd > Ned	843.30N > 221,25N

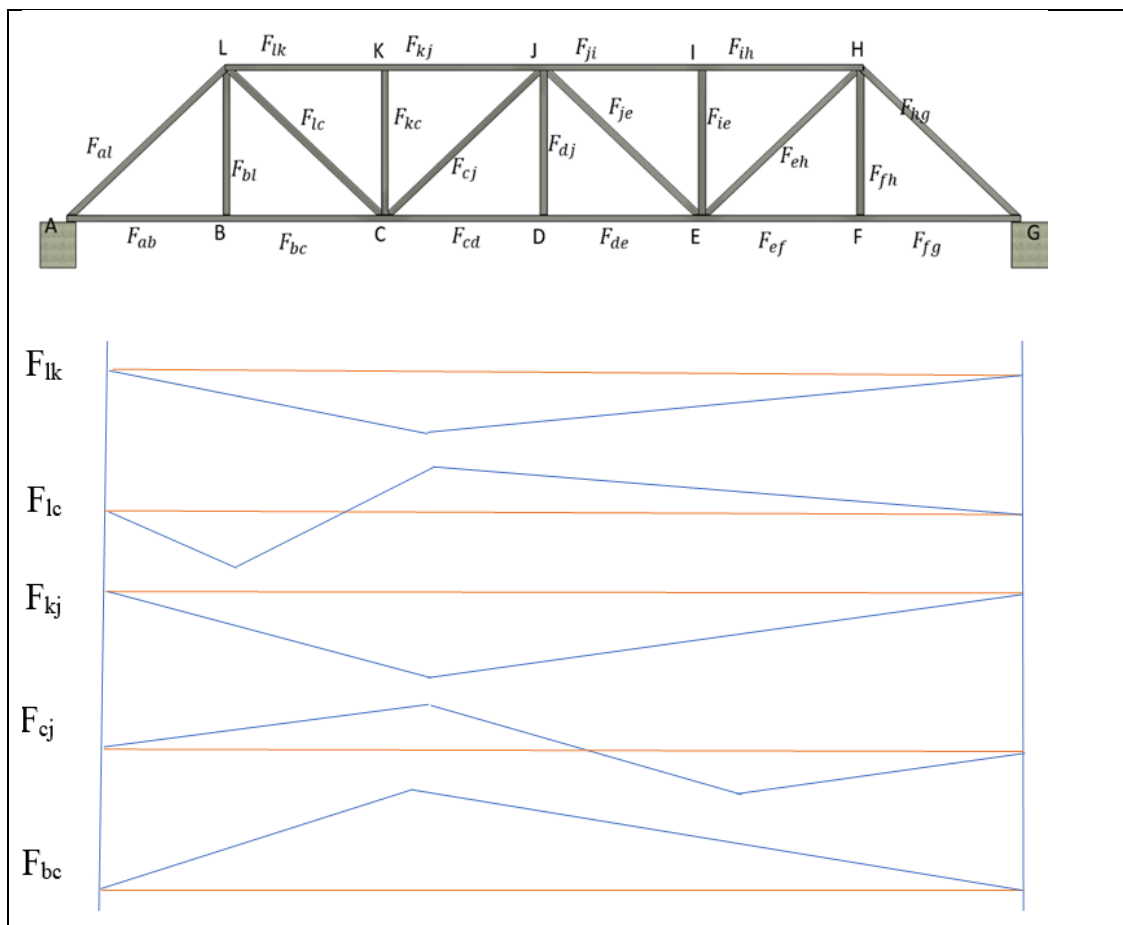

Figure 22: Influence line at truss bridge member lk, lc, kj, cj and bc

Table 8: Results of Theoretical Analysis when the load is 197.58N

Results from hand calculations when 197.58N force and unit load is applied at the midspan of the truss bridge						
Members	Force member by “n” [N]	Force member by “N” [N]	C=compression T= tension	Length i mm	$N_{cr} = \frac{\pi^2 EI}{(L)^2}$ [N/mm²]	P=N_{cr}/F [N]
F _{al}	-0.70	-139.14	C	707	770.22	-5.54
F _{lk}	-1.00	-197.58	C	500	1540.46	-7.80
F _{kj}	-1.00	-197.58	C	500	1540.46	-7.80
F _{ji}	-1.00	-197.58	C	500	1540.46	-7.80
F _{ih}	-1.00	-197.58	C	500	1540.46	-7.80
F _{hg}	-0.70	-139.14	C	707	770.22	-5.54
F _{fg}	0.50	98.79	T	500	1540.46	15.59
F _{ef}	0.50	98.79	T	500	1540.46	15.59
F _{de}	1.50	296.37	T	500	1540.46	5.20
F _{cd}	1.50	296.37	T	500	1540.46	5.20
F _{bc}	0.50	98.79	T	500	1540.46	15.59
F _{ab}	0.50	98.79	T	500	1540.46	15.59
F _{bl}	0.00	0.00	T	500	1540.46	00
F _{lc}	0.70	139.14	T	707	770.22	5.54
F _{kc}	0.00	0.00	T	500	1540.46	00
F _{cj}	-0.70	-139.14	C	707	770.22	-5.54
F _{dj}	1.00	197.58	T	500	1540.46	7.80
F _{je}	-0.70	-139.14	C	707	770.22	-5.54
F _{ie}	0.00	0.00		500	1540.46	00
F _{eh}	0.70	139.14	T	707	770.22	5.54
F _{fh}	0.00	0.00		500	1540.46	00

Displacement at a specified point in a structure refers to the amount and direction of movement that occurs at a point when the structure is subjected to an external load or force. In structural engineering, displacement is typically measured in terms of the change in position or location of a point in the structure relative to its original. The displacement at a specified point is an important parameter in structural analysis and design because it can be used to evaluate the structural performance and integrity of a structure under different loading conditions.

Table 9: Results of theoretical calculated deflection at each node in mm by 197.58N

Node	B	C	D	E	F
Deflection	0.016	0.029	0.041	0.029	0.016

There are two results, that can refer in this thesis. Result from the maximum designed load that is 197,58N in Table 9 and the load of 70.12N Table 10 that is using to have comparison with SAP2000 results.

Table 10: Results of theoretical calculated deflection at each node in mm by 70.12N

Node	B	C	D	E	F
Deflection	0.006	0.011	0.015	0.011	0.006

CHAPTER 5 FINITE ELEMENT METHODE (FEM)

FE analysis method is discussed. SAP2000 is used to evaluate the structural performance of the aluminum truss bridge under different loading scenarios.

5.1.1 *SAP2000*

SAP2000 is a computer program developed by Computers and Structures Inc. (CSI) and it is used for structural analysis and design. It is a finite element analysis software that is commonly used in the engineering industry. The software has been developed to analyze and design various types of structures such as buildings, bridges, long span trusses, towers, and dams. SAP2000 is a popular application for structural analysis and design with several features, including modelling, analysis, design, and visualization.

The Modeling feature allows for the creation of models of structures using various elements such as beams, columns, walls, and slabs. The software provides a graphical user interface that makes it easy to create and modify these models. SAP2000 uses the finite element method to perform a structural analysis in linear, nonlinear, static, and dynamic analyses. The software can also perform modal analyses and time history analyses. The software can be used to design various types of structures such as steel, concrete, timber, and aluminum. It can automatically generate design loads and load combinations according to various building codes and standards. Moreover, SAP2000 provides a 3D visualization of the model, making it easy to view and analyze the structure from different angles. The software also provides various tools for animating the structural response. User-friendly interface, versatility and accuracy are some of several advantages that make SAP2000 a popular choice for structural analysis and design. In this thesis SAP2000 version 23.3.1 is used to perform the finite element analysis of the truss bridge.

5.2 *2D and 3D Truss Bridge Modeling using SAP2000.*

A 2D and 3D finite element method analysis of the aluminum truss bridge is developed, and analytical results are obtained from both truss bridge models using design code NE 1997. A 2D truss bridge of 3000mm span-length model is developed in SAP2000 v.23.1. The model is created using truss template and it is sub-divided to create more frame elements. It has been assigned a pin support at one end and a roller at the other end of the bridge as shown in (Figure 23). The pin support has zero degree of freedom in x, y, z axis while it is free for rotation around the y axis. The y and z degree of freedom of the roller are set to zero DOF while the rest are non-zero. The Global coordinate system of the model is oriented in x, y and z axis, where x-axis lies along the truss span and z-axis along the truss bridge height. Moreover, SAP2000 represents any displacement in x-, y- and z-axis as u_1 , u_2 and u_3 , respectively.

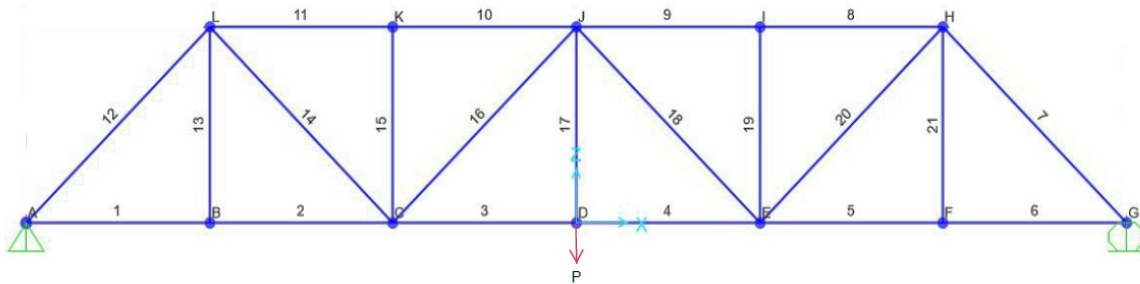

Figure 23: 2D-truss bridge model

Once the model is created, a frame of angle section 15x10x1mm and 12.5x12.5x1mm is defined for the cord and web members of the truss bridge, respectively (Figure 12). The cross section of the angle section frames is designed in section-designer, a separate built-in utility in SAP2000. Moreover, the material used for constructing the truss bridge is a tempered Al 1050A H14 and its properties are provided to SAP2000 from the datasheet delivered from the producer. The mechanical properties and chemical composition of the Al type is provided in Table 4. The final step in the modeling process is to apply loads and restraints to the structure and run the analysis. SAP2000 allows for the application of variety of loads, where in this analysis a point loads for the static and a moving load for the dynamic analysis was applied. The analysis results of stress, forces, displacement and deformed shapes are then obtained from the FEM for the 2D and 3D models.

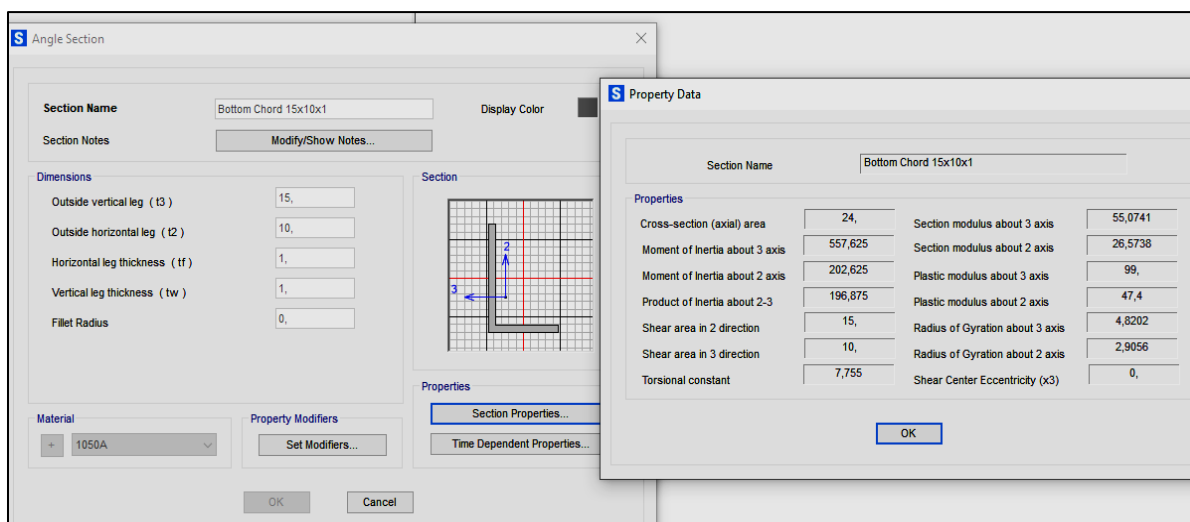

Figure 24: Angle section and its section properties

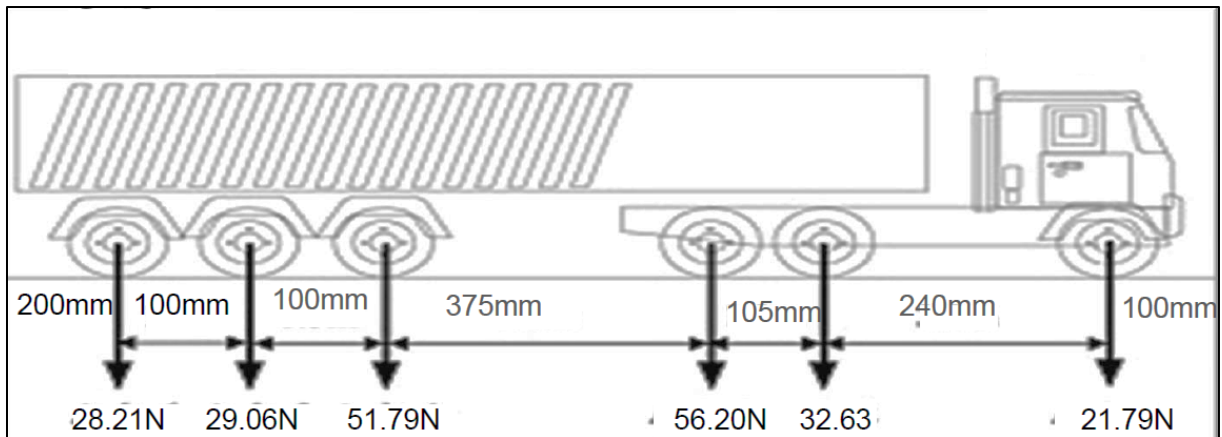

Figure 25: Multistep Moving Load

The experimental test and SAP2000 analysis, different load scenarios were considered. The first load scenario was a low speed that is 22cm/second with 8,5kg load. The second load scenario was with high speed which is 43cm/second and with same load. The third load scenario is with low speed and with 14,34kg load, the fourth scenario was with high speed with 14,34kg. By considering these load scenarios and conducting both experimental and SAP2000 analyses, a significant understanding of the structural behavior under different conditions can be obtained and that can help to final design of the real bridge in the ground.

5.3 Results From Numerical Analysis

The FEM results presented in 2D are due to static loading, while in the 3D are due to the static and dynamic loads.

5.3.1 2D truss bridge

Static Load:

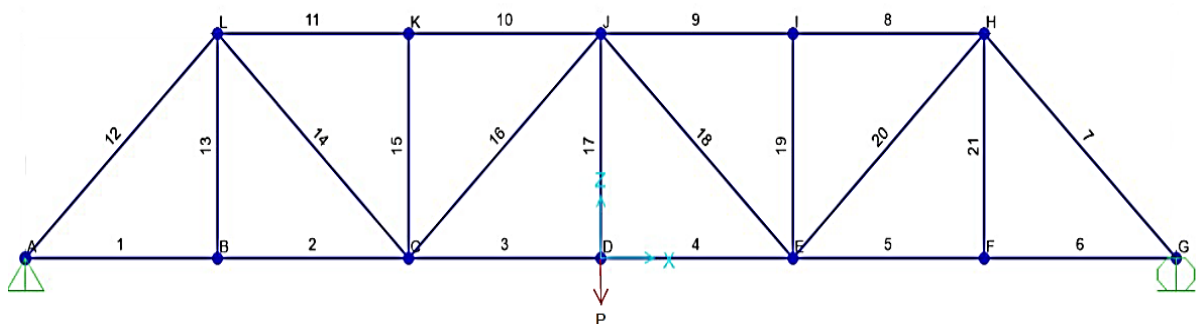

Figure 26: 2D truss bridge SAP model, including joints, members and load.

Table 11: Deflection results at joint located on bottom cord of 2D truss bridge from SAP2000.

Joint	Location from Global coordinate	Uz [$\ast 10^{-2}$ mm]
A	(-1500,0)	0
B	-1000	-34.132
C	-500	-62.302
D	0	-84.188
E	500	-62.151
F	1000	-34.057
G	1500	0

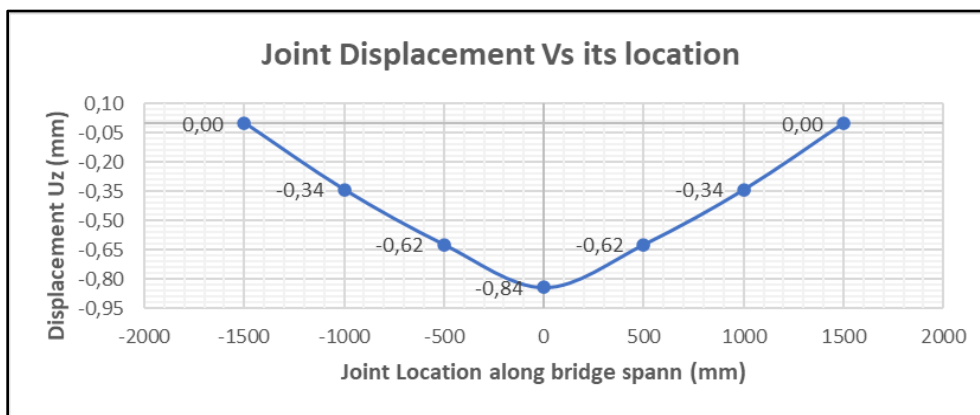

Figure 27: Deflection results from SAP2000 of joints located at bottom cord of the 2D truss bridge.

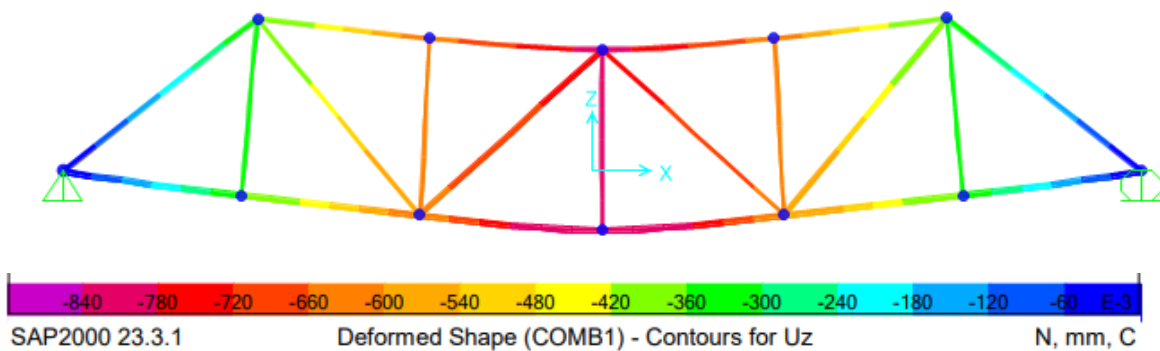

Figure 28 Deformed shape Uz of the 2D- Al truss bridge, static 125N load applied at midspan.

Deflection in a truss bridge refers to the deformation of its members under applied load. This deformed shape tells that the critical point is at the middle of the span.

Table 12: 2D Truss bridge members force results from SAP2000, Static load 125N

2D static load of 125N at joint D				
Frame name		Forces	Stress S11	Strain
SAP2000	Theoretical	N	N/mm2	$\mu\text{m/m}$
1	F_{ab}	98.27	4.32	57.67
2	F_{bc}	98.36	4.59	57.72
3	F_{cd}	289.31	13.24	169.78
4	F_{de}	289.30	13.23	169.78
5	F_{ef}	98.36	4.60	57.72
6	F_{fg}	98.28	4.25	57.67
7	F_{hg}	-138.77	-6.46	x
8	F_{ih}	-194.82	-9.96	115.96
9	F_{ji}	-194.96	-10.19	116.05
10	F_{kj}	-194.96	-10.10	116.05
11	F_{lk}	-194.82	-9.91	115.96
12	F_{al}	-138.77	-6.52	x
13	F_{bl}	0.90	1.23	
14	F_{lc}	136.63	6.52	
15	F_{kc}	-0.90	-2.70	
16	F_{cj}	-133.22	-6.65	
17	F_{dj}	187.92	8.06	
18	F_{je}	-133.20	-7.77	
19	F_{ie}	-0.70	-2.68	
20	F_{eh}	136.63	6.40	
21	F_{hf}	0.91	1.23	

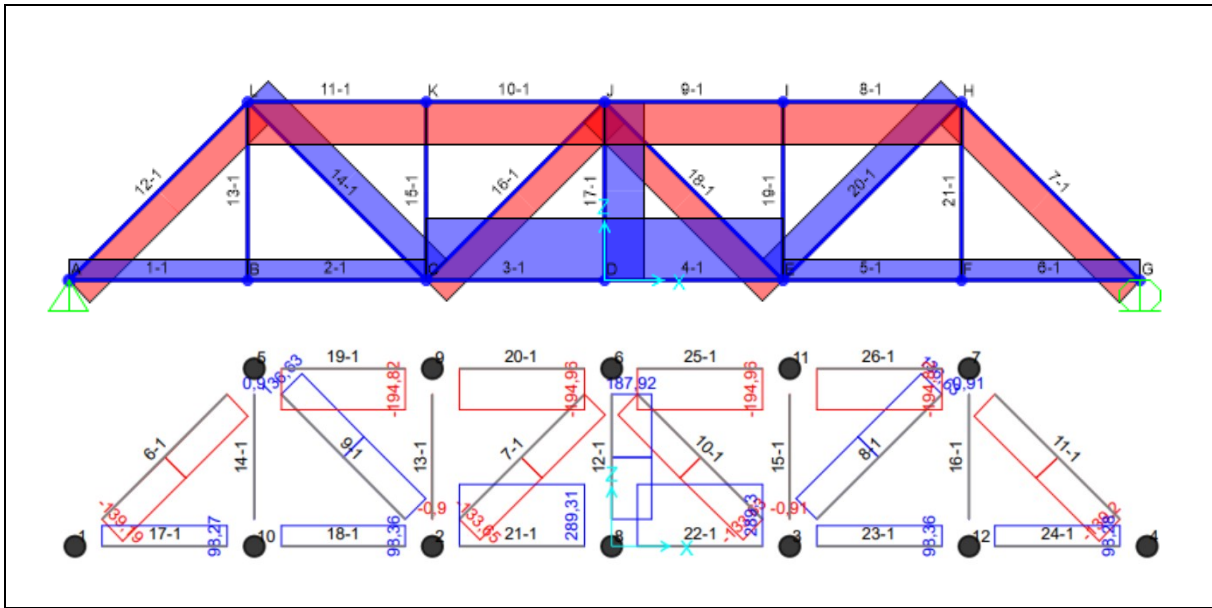

Figure 29 Member force results from SAP 2D static load of 125N at joint D

The member force in the above table refers to the internal forces experienced by the member of a structure. By examining the member forces obtained from SAP2000, engineering can approve that the members are within acceptable limits for stress, strength and deflection.

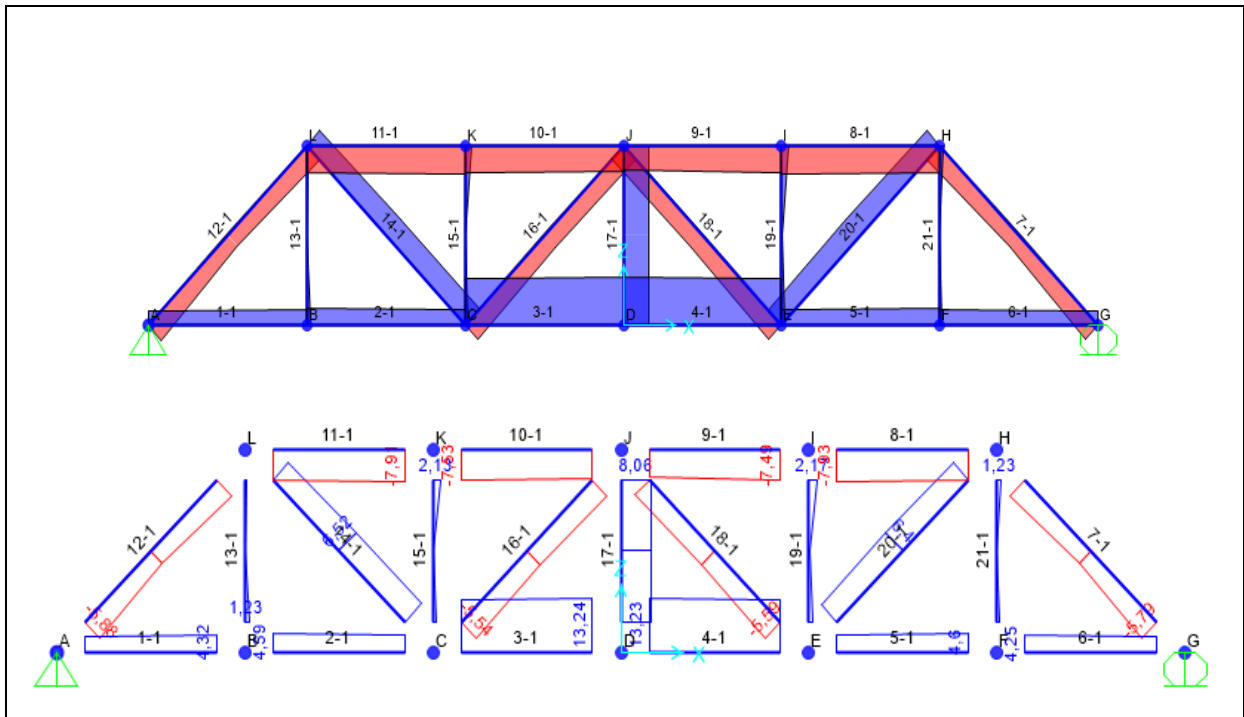

Figure 30 Stress results from SAP 2D static load of 125N at joint D

5.3.2 3D truss bridge

The results from 3D truss bridge modeled in SAP2000 are presented in this section. The results are divided into static loading case and multi-step moving load dynamic case.

Static Load Results:

Displacement SAP results at each joint of the bottom cord of static analyzed 3D truss bridge subjected to 70N force at joint D (mid-span) are presented on Figure 31.

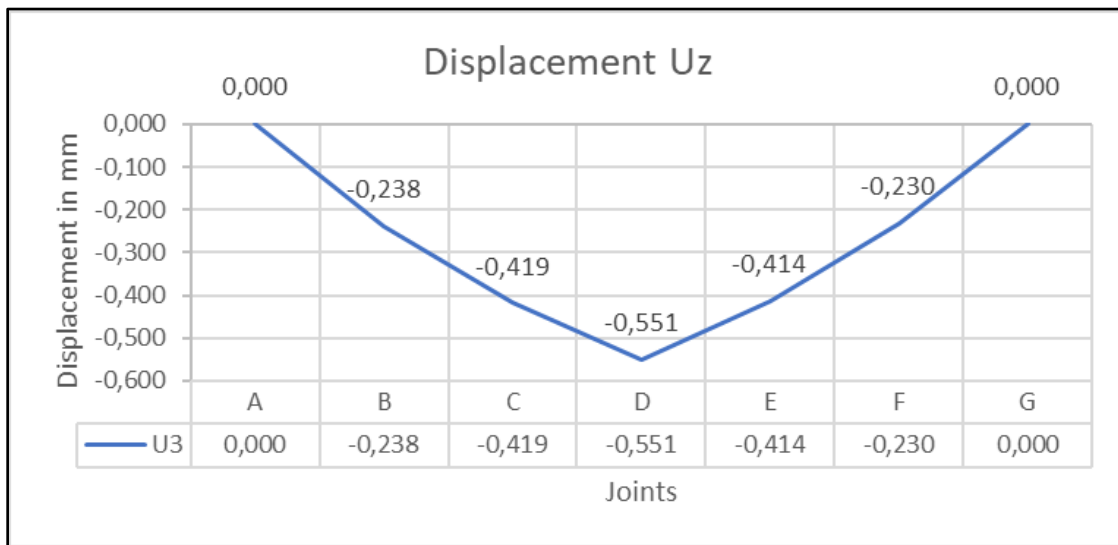

Figure 31: Displacement results from SAP 3D truss bridge model due to 70N static load located at joint D.

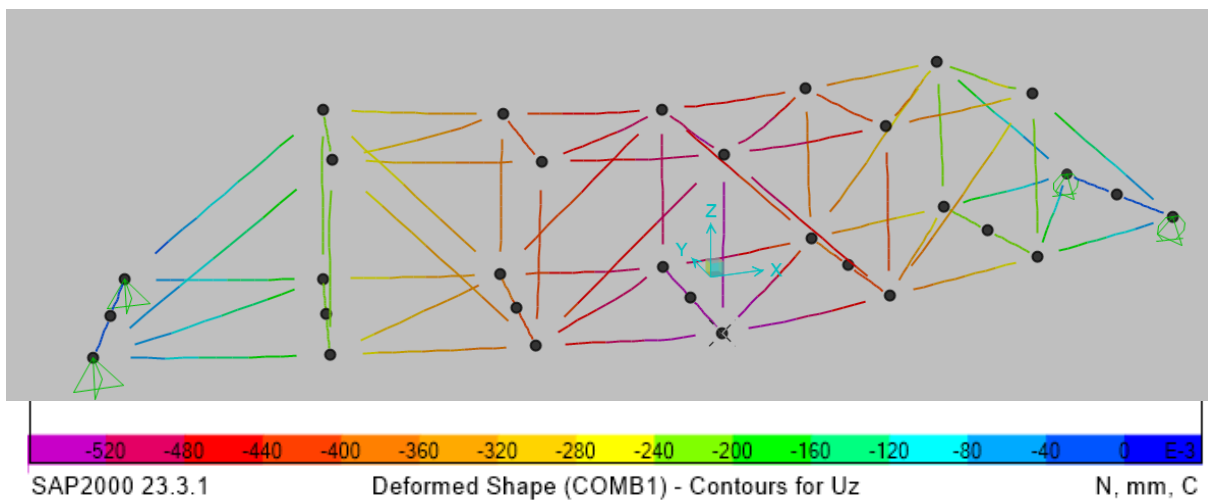

Figure 32: Deformation when a static load is applied at mid span of 3D truss bridge from SAP2000.

Table 13: Results from SAP2000 3D static load of 70N at joint D.

Frame name		Forces	Stress S11	Strain
SAP2000	Theoretical	N	N/mm2	*10 ⁻⁶
1	F _{ab}	86.05	3.788	54.114
2	F _{bc}	81.93	3.565	50.929
3	F _{cd}	194.05	8.646	123.514
4	F _{de}	189.52	8.773	125.329
5	F _{ef}	69.62	3.276	46.800
6	F _{fg}	65.74	2.863	40.900
7	F _{hg}	-92.9	-4.022	-57.457
8	F _{ih}	-126.68	-6.607	-94.386
9	F _{ji}	-127.24	-6.325	-90.357
10	F _{kj}	-127.85	-5.676	-81.086
11	F _{lk}	-128.42	-5.613	-80.186
12	F _{al}	-93.01	-6.304	-90.057
13	F _{bl}	4.43	-2.775	-39.643
14	F _{lc}	87.25	3.772	53.886
15	F _{kc}	-1.7	1.208	17.257
16	F _{cj}	-77.6	-3.254	-46.486
17	F _{dj}	108.74	4.769	68.129
18	F _{je}	-77.46	-3.735	-53.357
19	F _{ie}	-0.99	1.273	18.186
20	F _{eh}	86.22	3.968	56.686
21	F _{hf}	4.1	1.525	21.786

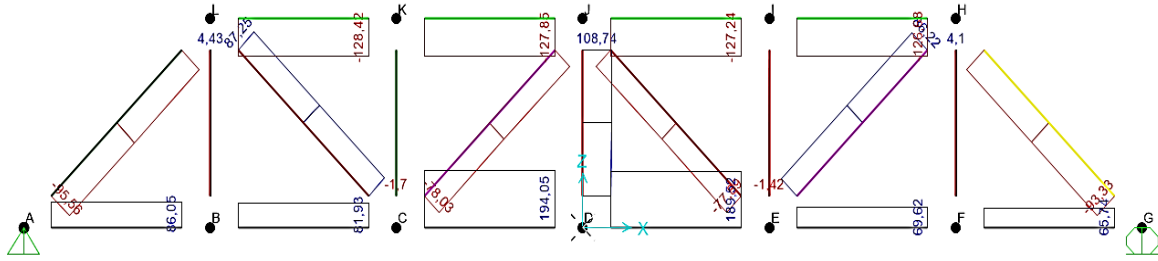

Figure 33: Member forces of 3D truss static load applied at mid-span from SAP2000.

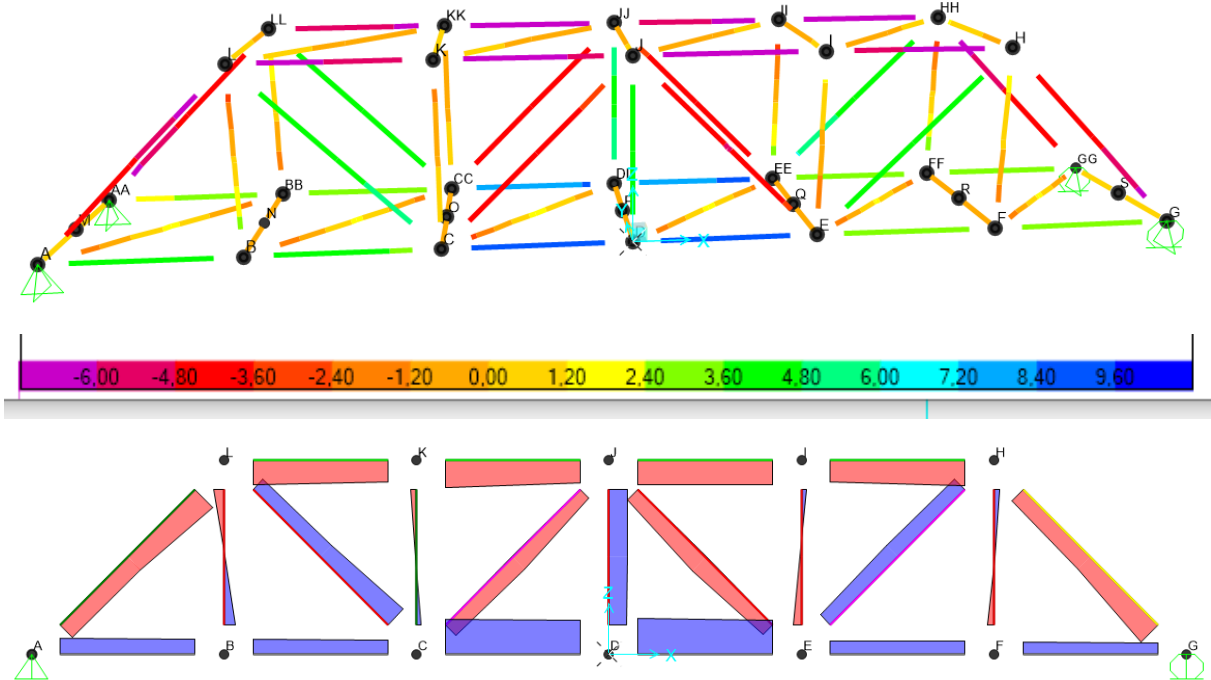

Figure 1: Stress results of 3D truss bridge from SAP2000 when a static load applied at mid-span.

Dynamic load Results:

Displacement at each joint along the bottom cord when multi-step moving truck dynamic load is applied.

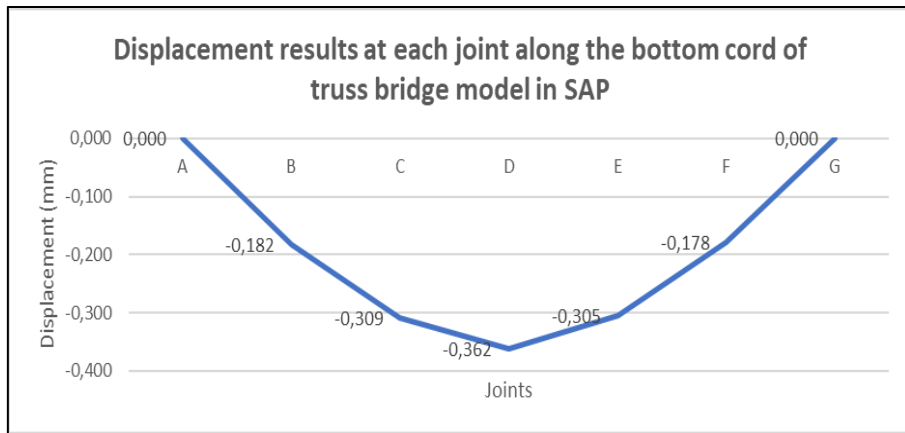

Figure 34 Displacement results from SAP multi-step analysis at each joint of the bottom cords

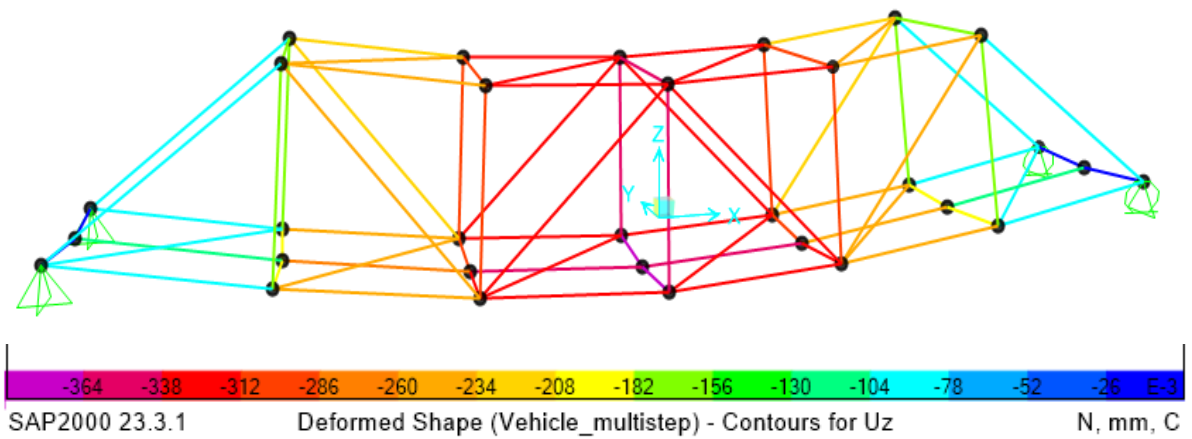

Figure 35: Deformation (Uz) results 3D dynamic analysis from SAP2000

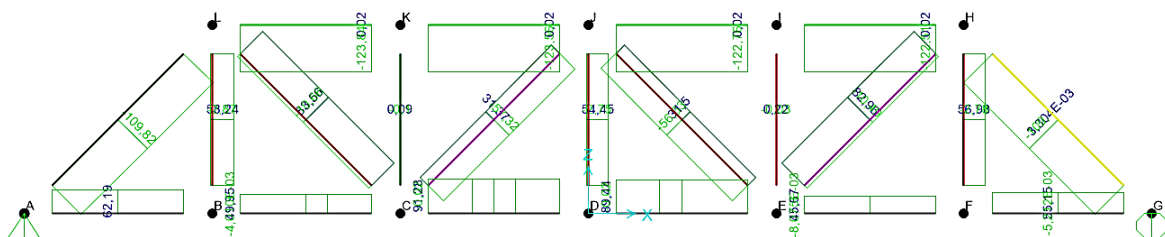
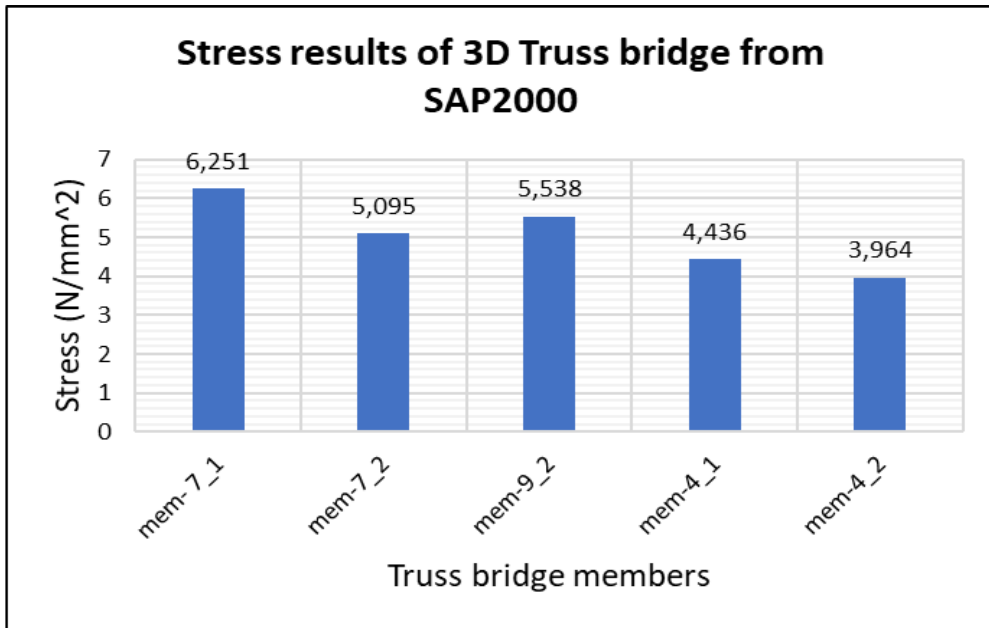

Figure 36: Dynamic 3D- member forces from SAP2000

Table 14 SAP results of multi-step moving load of 219.68N

Frame name		Forces	Stress S11	Strain
SAP2000	Theoretical	N	N/mm2	*10 ⁻⁶
1	F _{ab}	62.78	3.239	46.271
2	F _{bc}	50.4	2.663	38.043
3	F _{cd}	92.12	4.422	63.171
4	F _{de}	90	4.436	63.371
5	F _{ef}	45.64	2.734	39.057
6	F _{fg}	54.89	3.199	45.700
7	F _{hg}	-108.16	-6.251	-89.300
8	F _{ih}	-122.72	-5.641	-80.586
9	F _{ji}	-123.01	-5.601	-80.014
10	F _{kj}	-124.27	-5.745	-82.071
11	F _{lk}	-124.54	-5.896	-84.229
12	F _{al}	-110.25	-6.318	-90.257
13	F _{bl}	58.35	4.533	64.757
14	F _{lc}	84.55	5.114	73.057
15	F _{kc}	-0.11	-1.636	-23.371
16	F _{cj}	-58.26	-2.56	-36.571
17	F _{dj}	55.14	3.113	44.471
18	F _{je}	-56.15	-3.372	-48.171
19	F _{ie}	0.22	-2.079	-29.700
20	F _{eh}	81.8	3.436	49.086
21	F _{hf}	58.02	2.991	42.729



(a) Maximum stress of members 7, 9 and 4

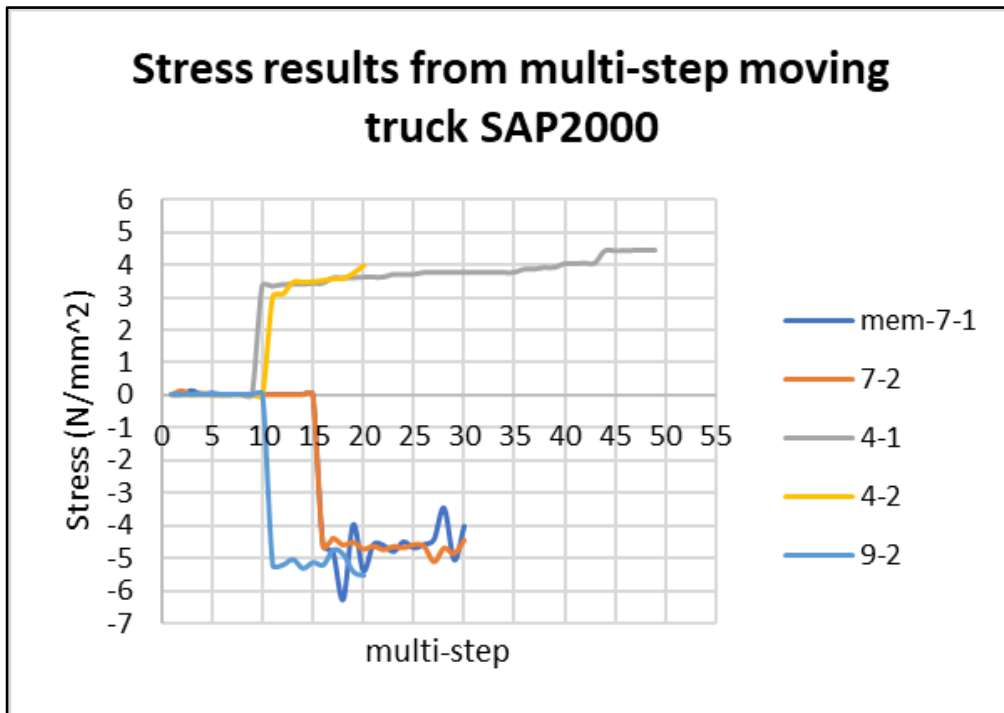

(b) Instantaneous stress values on members 7, 9, 4

Figure 37: Stress results from SAP of a multi-step moving load 219.68N

During a multi-step moving truck analysis in SAP2000, the software calculated the stress results at different locations along the members. These stress results provided information about the internal force and moments experienced by the members as the truck moves over them.

CHAPTER 6 EXPERIMENTAL INVESTIGATION

A 3D truss is tested in the laboratory of university of Stavanger. The strains at members are measured using strain gauges during static and dynamic load case. In this section the experimental process and its results are presented.

6.1 *3D Truss Bridge Experimental Test*

6.1.1 *Tools and testing machines.*

Strain Gauge

Strain gauges can be used to measure a strain such as tensile and compressive, shear and bending strain. They are commonly used in controlling and testing of critical structures such as bridges, tunnels, buildings, aircraft and in the development of sensors and other electronic devices. One of the key advantages of strain gauges is their high accuracy and sensitivity, which allows for precise measurements of deformation and strain. They are also relatively easy to install and use for a wide range of applications. A strain gauge made of a metallic coil glued to an insulated flexible backing. It is then glued to a structure to make a measurement. When a load is applied to the structure, the electrical resistance of the foil starts to change. The change of resistance is measured by a Wheatstone bridge. The Wheatstone bridge is related to the strain by a Gauge Factor (GF). The strain gauge factor used in this thesis is 2.13. The principle of a strain gauge is that if the strain gauge gets stretched and becomes thinner, the resistance increases since the resistance is length divided by area ($R=L/A$, where R is resistance, L is the length and A is the cross-section area of the wire). If the resistance measured is less, the gauge becomes shorter and wider in width. From the electrical resistance measured by the strain gauge the strain in the structure due to the applied load can be then obtained.

A Strain gauge is to be used in this thesis to measure the stress limit of the aluminum truss bridge model. A strain gage is a sensor device that is physically attached to the structure, and it changes its resistance as the shape of the structure deforms.

$$\sigma = E\varepsilon = \frac{F}{A}$$

Equation 17

$$\varepsilon = \frac{\Delta L}{L}$$

Equation 18

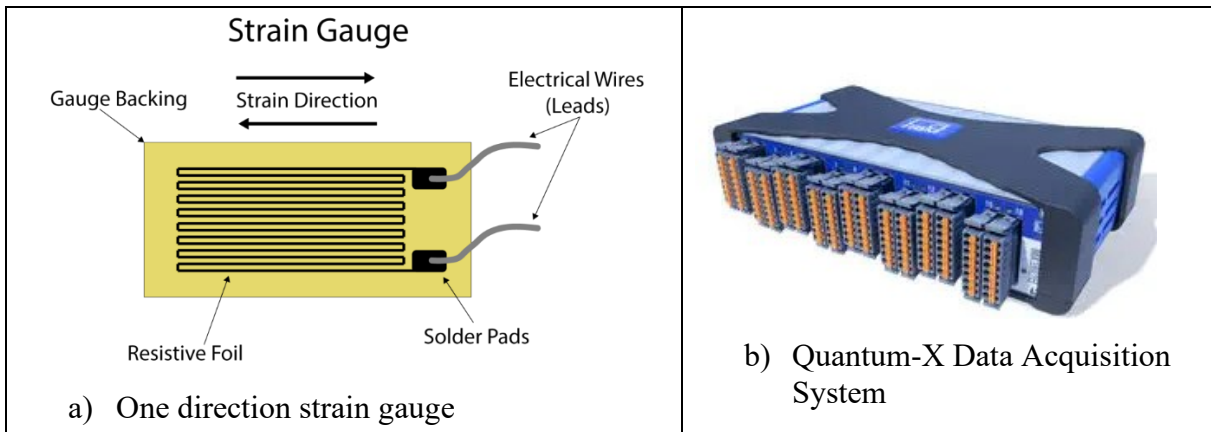

Figure 38: Typical one directional strain gauge and bridge amplifier of Quantum-X family

The QuantumX Data Acquisition System (Figure 38) was used to read data from a strain gauge-based Wheatstone bridge connected to an aluminum truss bridge model. By measuring the changes in electrical resistance caused by the strain, the QuantumX system captured and saved the strain data. Moreover, it provides user-friendly software for visualizing, analyzing, and reporting acquired data. This setup helped us study how the aluminum behaved and changed shape under different loads.

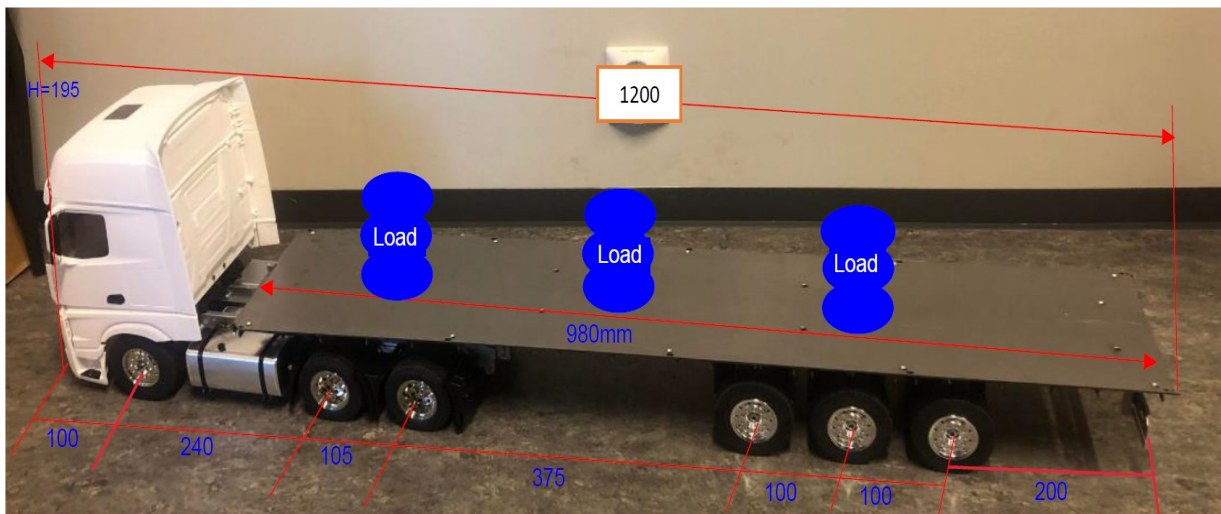

Figure 39 The truck model used in the experimental test.

In the experimental test, a truck measuring 1200mm in length was employed. The truck has a base weight of 8.5 kg when unloaded, and it has the capacity to carry an additional load of up to 15 kg. the maximum speed of the truck is 43cm/second while its low speed 22cm/second.

6.2 Results from Experimental Test

A static and dynamic scenario was considered. A force of 140.68N and 219.68N for static and dynamic scenarios are applied, respectively.

6.2.1 Static Load

Strain is measured on 5 members of the 3D truss bridge, where members 4_1 and 4_2 are in tension and the rest are in compression. The values obtained from the experimental test are presented in (Figure 38 and Table 15)

Table 15 Average Strain values obtained from strain gauge at joint D.

Description	Member_7_1_Top	Member_7_1_side	Member_7_2	Member_9_2	Member_4_1	Member_4_2
Strain	-13,89	-46,56	-15,05	-47,02	52,04	52,64
Strain ab	13,893	46,556	15,054	47,024	52,036	52,637
Stress	-0,973	-3,259	-1,054	-3,292	3,643	3,685
Force	-23,341	-78,214	-25,291	-79,000	87,421	88,430

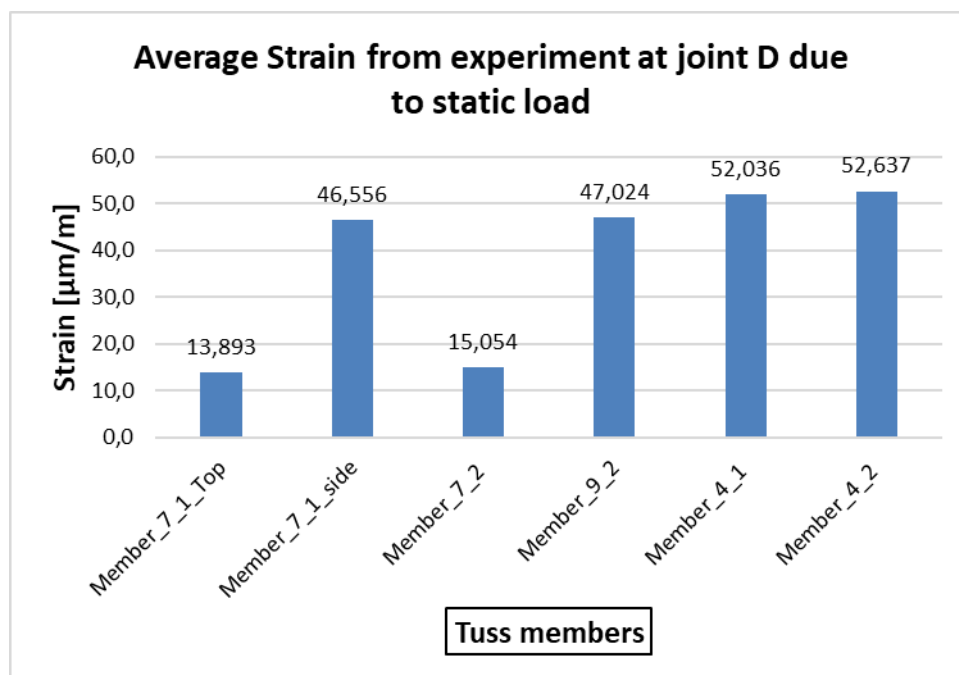

Figure 40: Average strain from experimental test at joint D due to static load

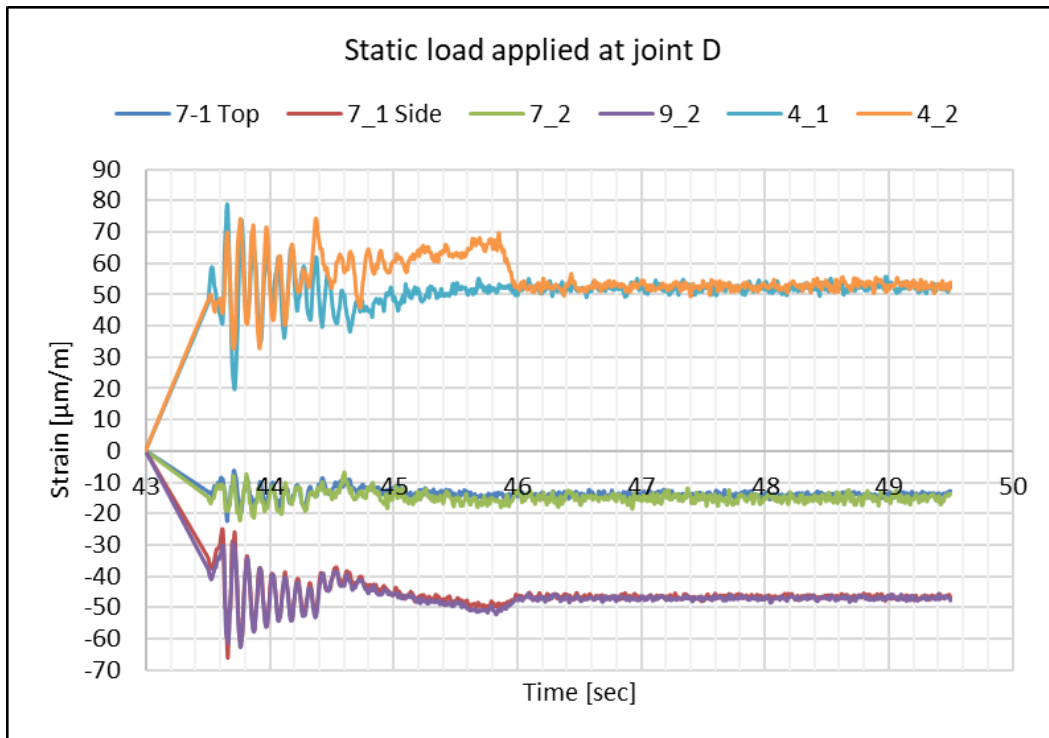

Figure 41 Strain values from static experimental test of the 3D truss bridge.

From a gauge a deflection of 0.422mm was measured at the midspan of the truss bridge as shown in Figure 42.

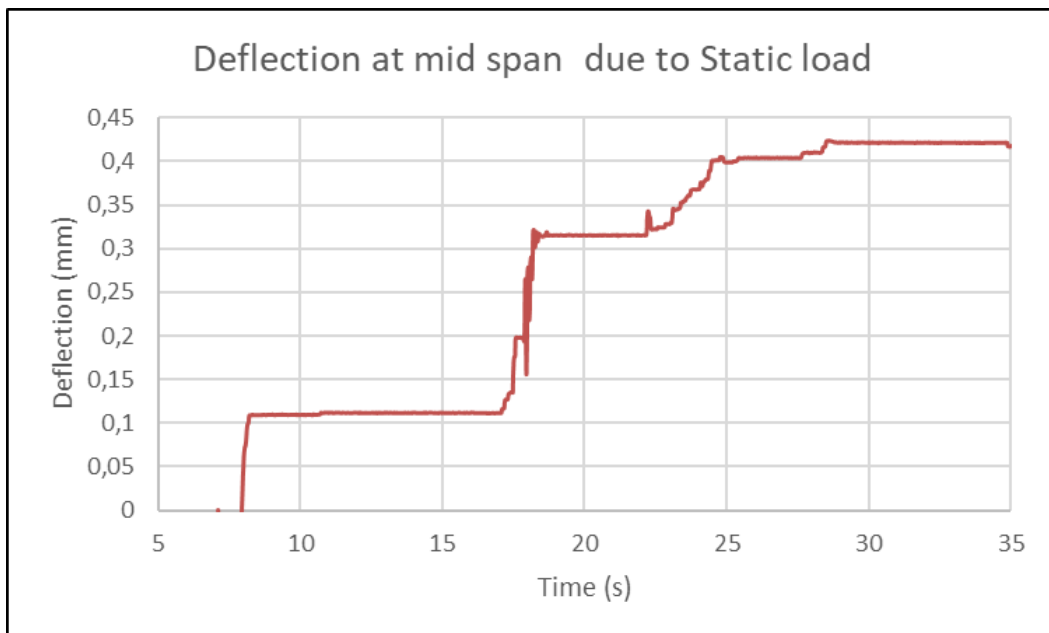

Figure 42 Deflection of truss bridge due to static load at joint D

Table 16 Average strain values measured at joint B due to Static load.

	Mem 7_1_Top	Mem 7_1_side	Mem 7_2	Mem 9_2	Mem 4_1	Mem 4_2
Strain *10 ⁻⁶	-3,840	-14,827	-7,441	-15,304	13,324	17,201

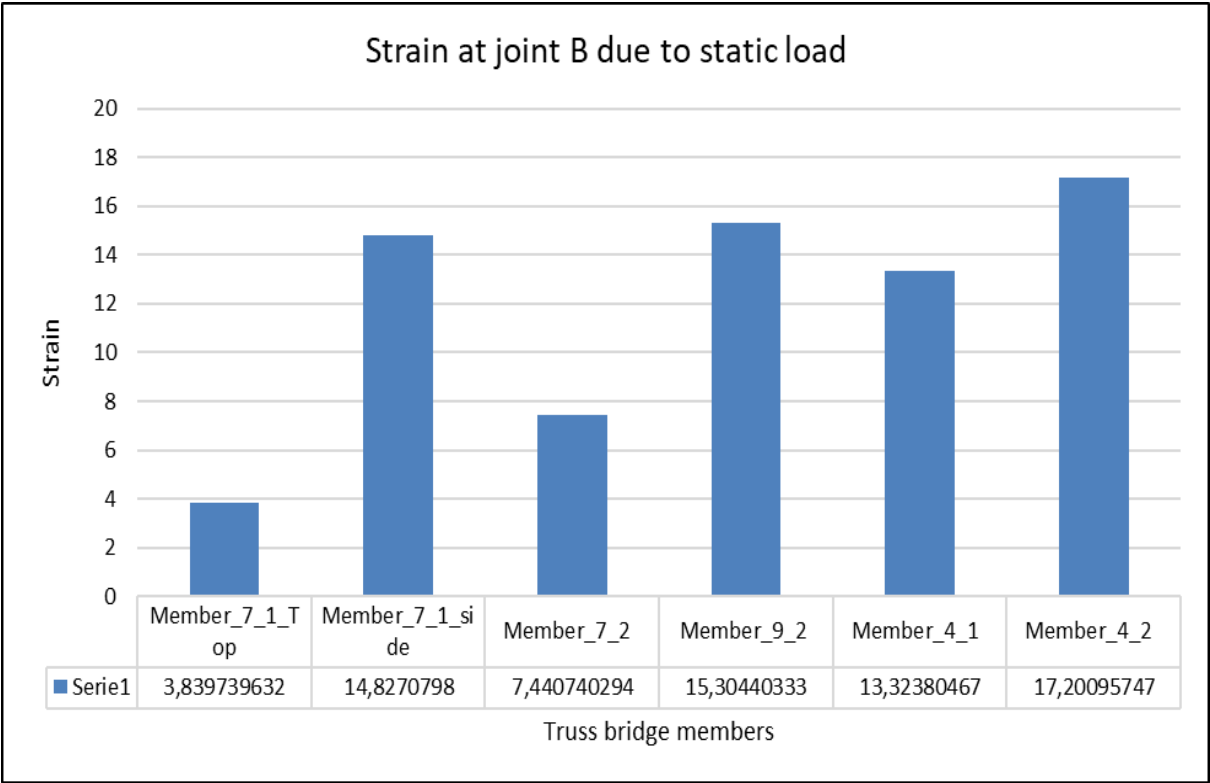

Figure 43: Strain at joint B due to static load

6.3 Dynamic load

Deflection:

Experimental deflection results at mid-span are presented at Figure 44.

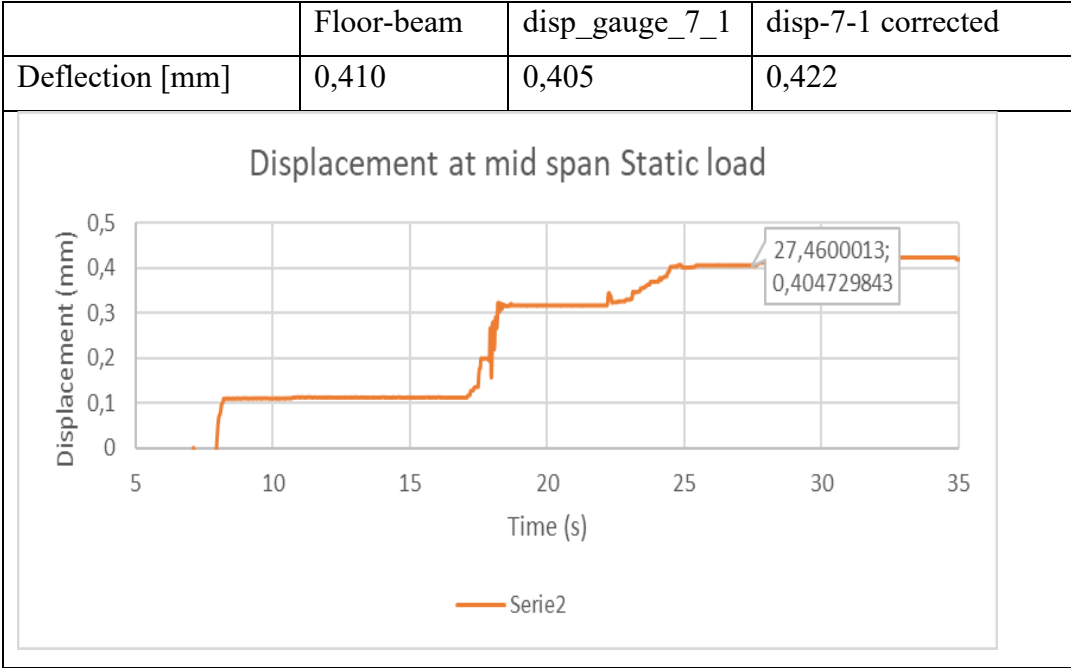

Figure 44: Deflection at mid span of the truss bridge from experimental test using gauge.

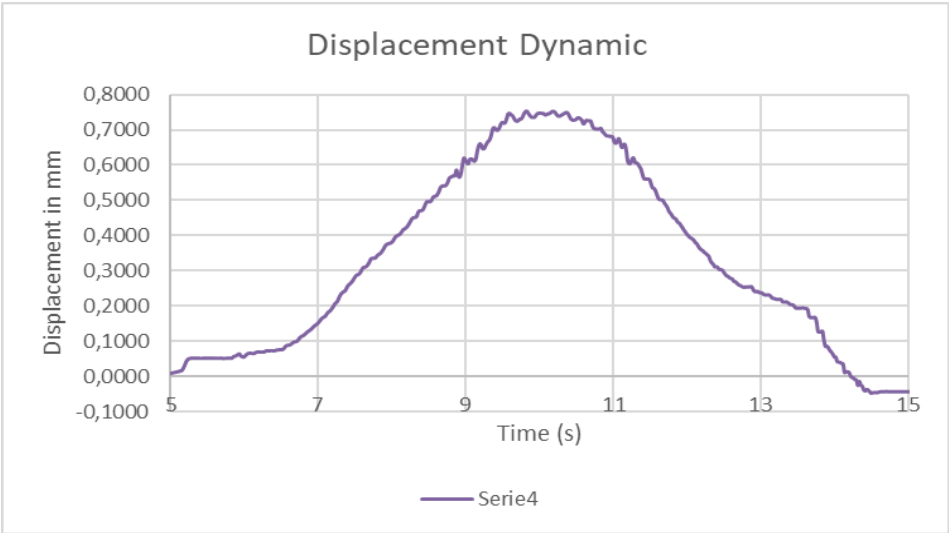

Figure 45 experimental displacement results of 3D Al truss bridge loaded with a moving truck measured at floor beam of joint D.

In Figure 45 when the load is applied to the truss bridge, then more displacement is measured at the floor beam of the truss bridge. The stringer transfers the load to the floor beam and the floor beam is weaker than the bottom cord that cause more displacement at the floor beam. The

cross-section of the floor beam should be designed stronger than the bottom cord. Strengthening the floor beam would allow it to better withstand the transferred load to the bottom cord and to minimize its displacement.

The moving load was tested with low and high speed at 22cm/s and 43cm/s, respectively. The results are presented below.

6.3.1 Low speed 22cm/s

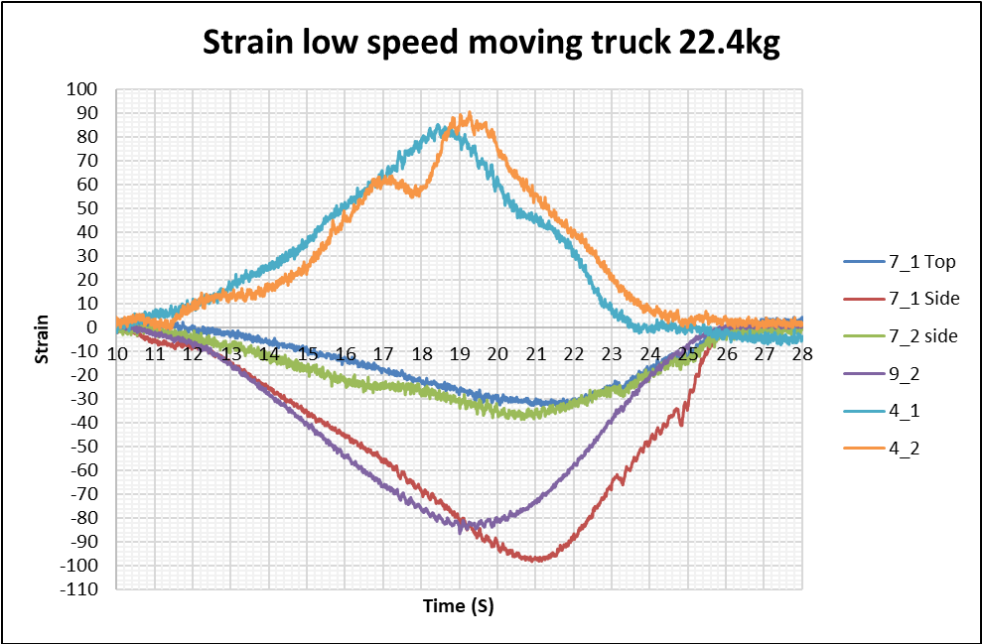

Figure 46: Strain at truss member vs time due to a low-speed multi-step moving truck.

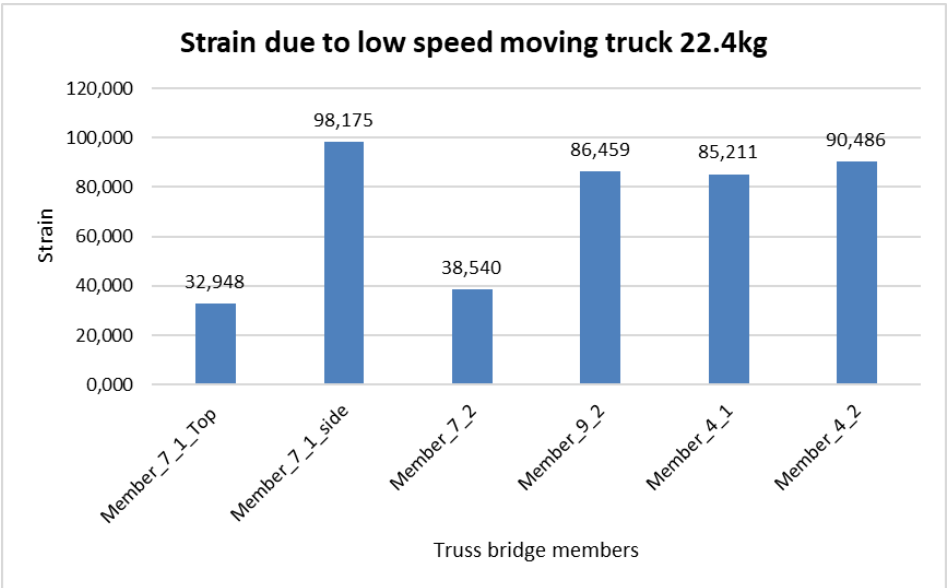

Figure 47: Max-strain at truss members due to low speed moving truck.

Table 17 Strain, Stress, member Forces from high speed 22.4kg moving truck.

	Mem_7_1_ Top	Mem_7_1_ side	Mem_7_2	Mem_9_2	Mem_4_1	Mem_4_2
Strain	35,039	100,298	39,006	85,042	85,625	91,314
Stress	-2,453	-7,021	-2,730	-5,953	5,994	6,392
Force	-58,865	-168,500	-65,530	-142,870	143,851	153,407

6.3.2 High-speed 43cm/s

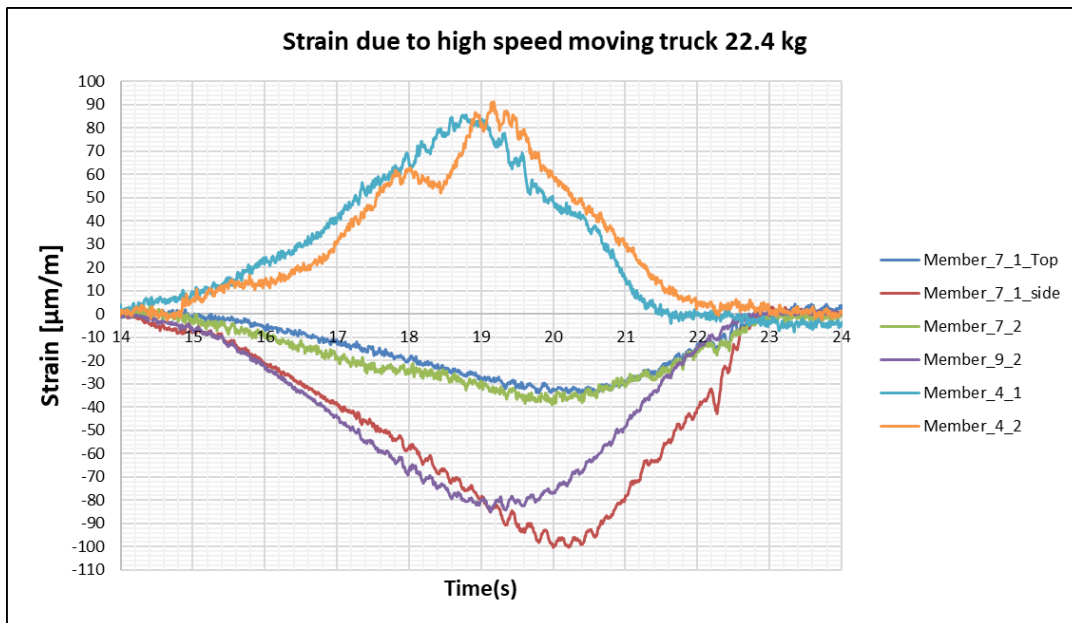

Figure 48: Strain at truss member vs time due to a high-speed multi-step moving truck.

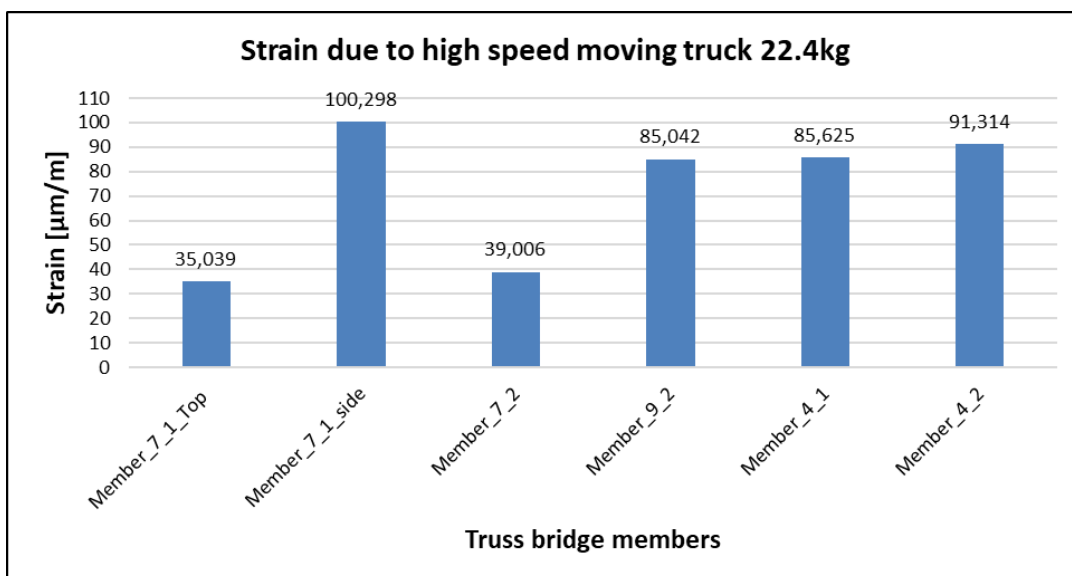

Figure 49: Max-strain at truss members due to high-speed moving truck.

6.3.3 *Hard break high speed*

Hard break of 22.4kg high-speed moving truck at the mid span of the truss bridge.

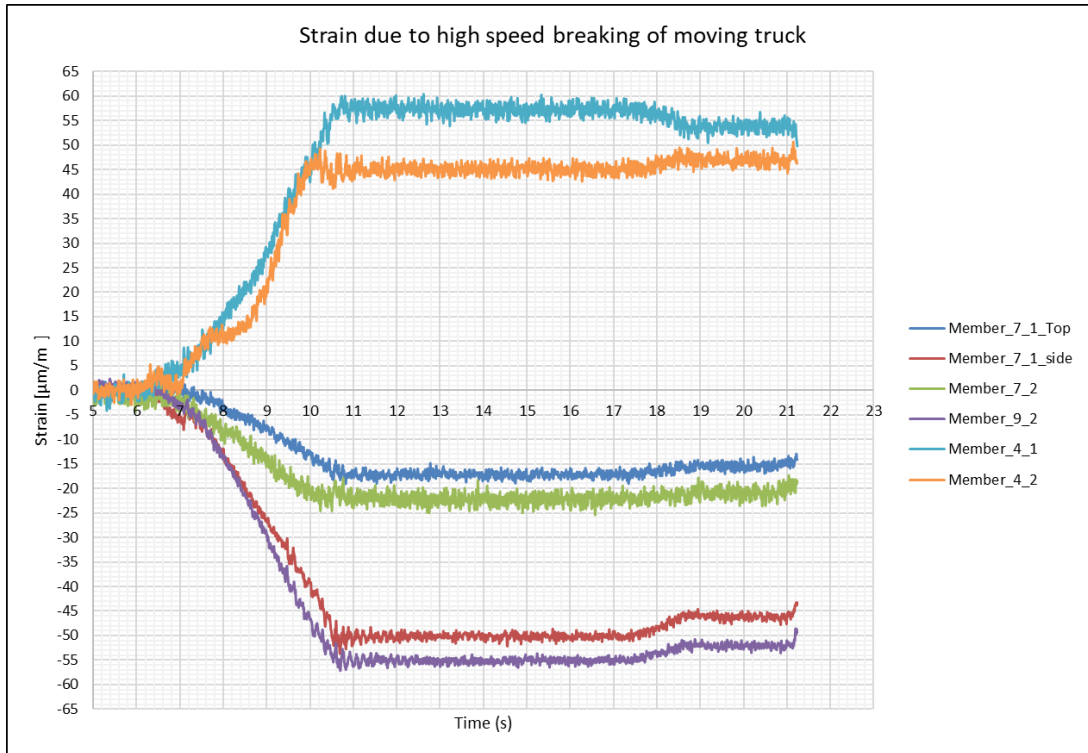

Figure 50 Strain due to hard breaking of a high-speed moving truck

CHAPTER 7 RESULT DISCUSSION / COMPARISON

The results obtained from the numerical and theoretical analysis and experimental test are discussed in this section.

7.1 *Static result comparison*

The results obtained from experimental test, 2D-theoretical and numerical analysis are presented in Table 19. The results of axial forces and strain have a significant similarity.

Table 18: Element Forces and Stress from Experimental, Analytical and SAP from static analysis when 70N load is applied at joint D.

Element Forces and Stress from Experimental, Analytical and SAP from static analysis when 70N load is applied at joint D.						
Frame name	P-theor_2D	P-Sap_3D	P-Lab_3D	σ_{Sap}	σ_{Lab}	σ_{theor_2D}
SAP	N	N	N	N/mm2	N/mm2	N/mm2
1	35.06	86.05		3.788		1.95
2	35.06	81.93		3.565		1.95
3	105.18	194.05		8.646		5.84
4	105.18	189.52	88.43	8.773	3.68	5.84
5	35.06	69.62		3.276		1.95
6	35.06	65.74		2.863		1.95
7	-49.38	-92.9	-78.21	-4.022	-3.23	-2.74
8	-70.12	-126.68		-6.607		-3.90
9	-70.12	-127.24	-79.00	-6.325	-3.29	-3.90
10	-70.12	-127.85		-5.676		-3.90
11	-70.12	-128.42		-5.613		-3.90
12	-49.38	-93.01		-6.304		-2.74
13	0.00	4.43		-2.775		0.00
14	49.38	87.25		3.772		2.74
15	0.00	-1.7		1.208		0.00
16	-49.38	-77.6		-3.254		-2.74
17	70.12	108.74		4.769		3.90
18	-49.38	-77.46		-3.735		-2.74
19	0.00	-0.99		1.273		0.00
20	49.38	86.22		3.968		2.74
21	0.00	4.1		1.525		0.00

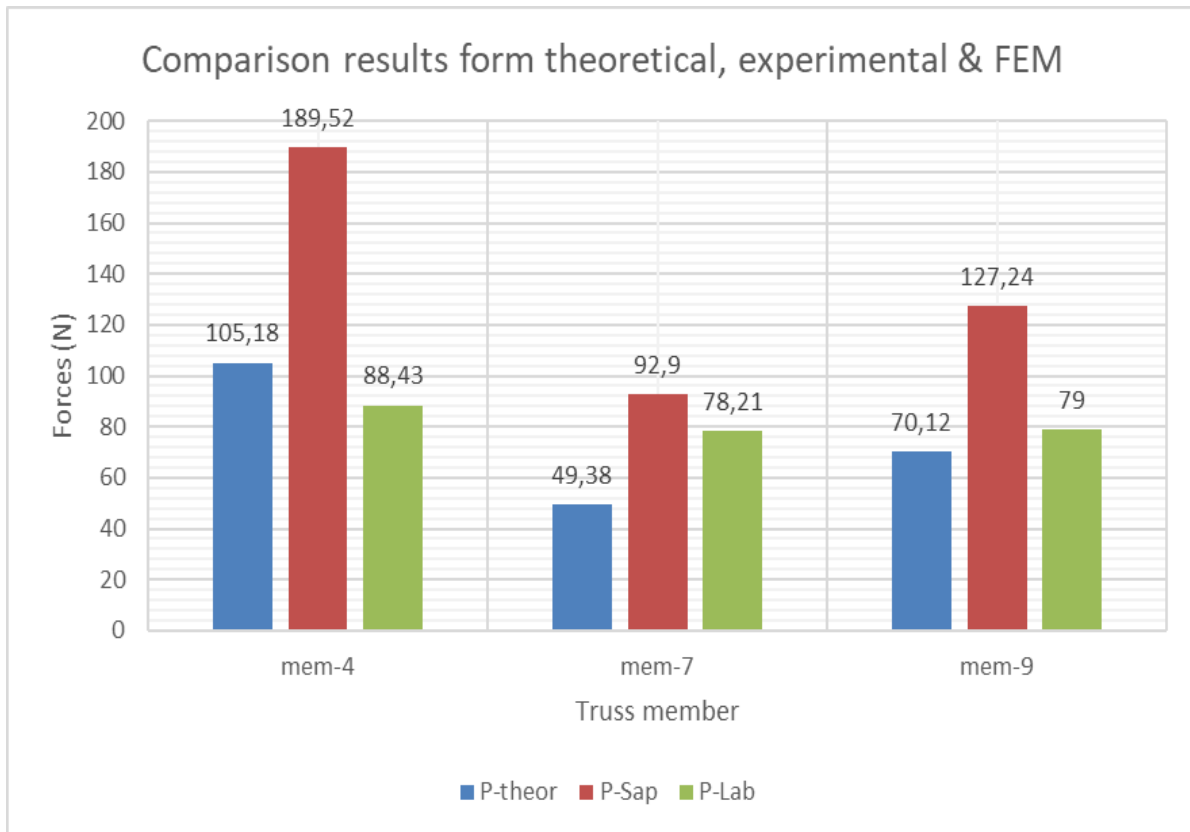

Figure 51: Comparing force results from theoretical, experimental and numerical analysis.

The force results obtained from the theoretical and experimental are relatively similar while the results from FEM have a considerable difference as shown in Figure 51. The FEM results presented are obtained using a load combination case as in Equation 2. The difference can be due to the assumptions taken in the theoretical analysis and measuring errors during laboratory test.

Table 19: Results from experimental lab, hand calculations vs SAP2000 a static load applied at mid-span of the 3D truss bridge.

Description	Hand calculations	Lab	SAP2000
Displacement at mid span (mm)	-	0.422	0.362
Stress at member 9 N/mm ²	2.92	2.98	3.12
Axial force member 9 (N)	70.12	70.48	70.03
Strain (µm/m)	41.71	42.56	41.06

The results presented in Table 19 shows the significant similarity in the theoretical, experimental and numerical analysis when only live load is considered during extracting the results from SAP2000.

7.2 Dynamic result comparison

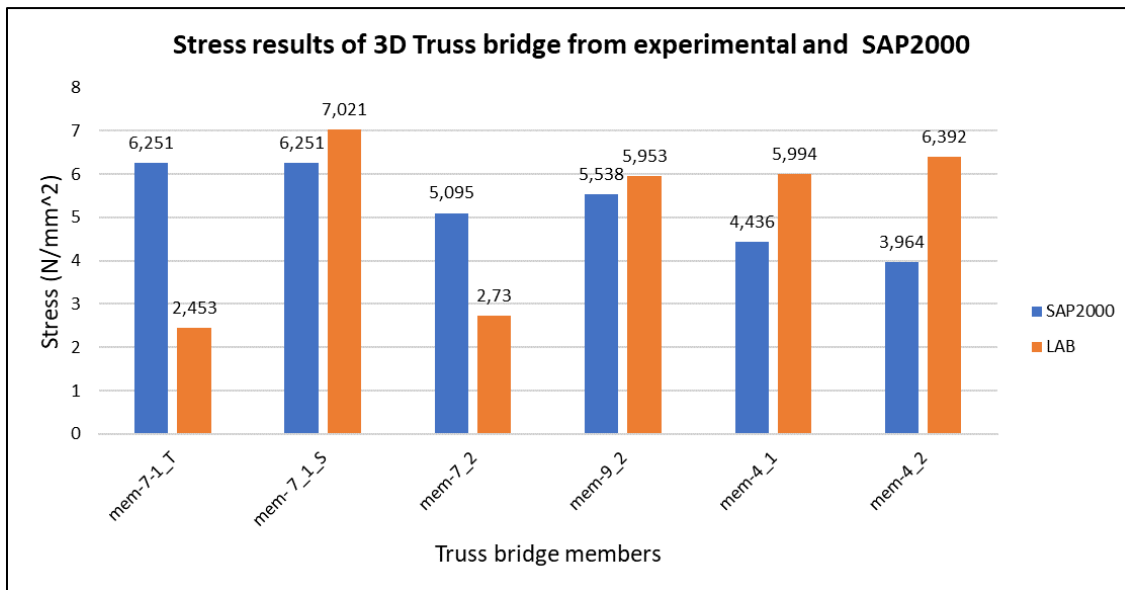

Figure 52: Stress results of 3D truss bridge from experimental and SAP2000

The stress results of the truss bridge, obtained from both SAP2000 analysis and experimental measurements using strain gauges, are shown in (Figure 52). It is important to note that there is a significant difference observed between the stress values for Member 7-1-Topp and Member 7-1-side. This difference can occur that the measurements were taken at two different locations along these members. The stress values obtained from SAP2000 analysis represent the theoretical calculations based on the structural model and assumptions inputted into the software. On the other hand, the experimental measurements using strain gauges involve physically attaching sensors to the bridge members to directly measure the strain, which is then used to determine the stress.

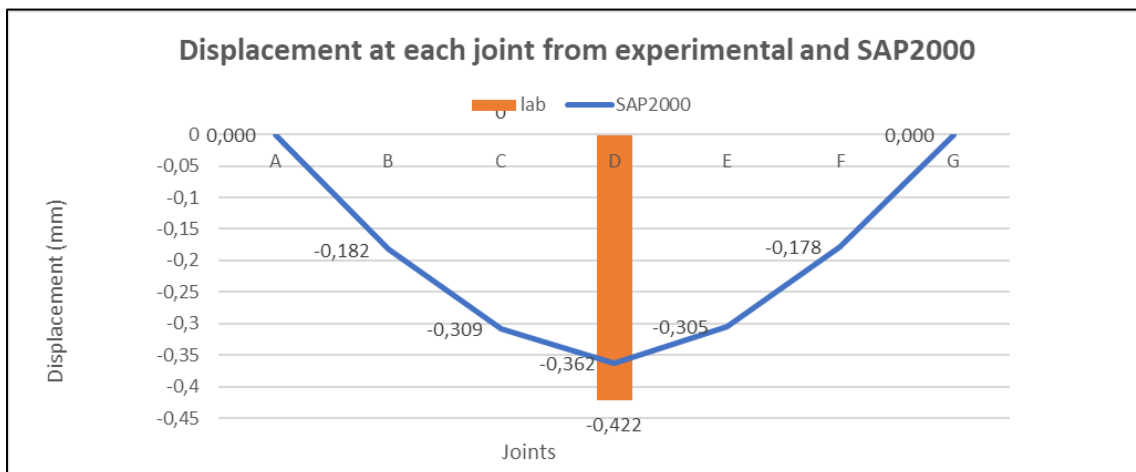

Figure 53: Displacement at each joint from experimental and SAP2000

Displacement at each joint from experimental (strain gauge) and from SAP2000 are almost the same and this indicates that the truss bridge design is in excellent condition.

CHAPTER 8 CONCLUSION

This bachelor thesis focuses on the design, fabrication, and analysis of a truss bridge made of aluminum metal. The truss bridge is first designed theoretically as 2D truss bridge, and it is redesigned as 3D and optimized using SAP2000. The numerical analysis using SAP2000 leads to more accurate understanding of the bridge's performance under various loading conditions. Once the truss bridge is fabricated, the experimental results are obtained using Strain-gauges. To confirm the theoretical analysis and SAP2000 an experimental test was conducted on the fabricated truss bridge.

The bridge was subjected to a maximum load of 140.60 and 219.68N in static and dynamic cases respectively. The loads are slightly below the maximum design load of 245.25N. A maximum stress value of 3.69 N/mm² in the static and 7.02 N/mm² from the dynamic load case are obtained. Moreover, the truss bridge was designed to have maximum allowable design stress of 12.35 N/mm² and it was capable to carry the experimental test load safely. The results from the theoretical and experimental are relatively similar. However, the results from FEM indicate a considerable difference. The difference can be due to the assumptions taken in the theoretical analysis and measuring errors during laboratory test. However, the overall results confirm that the design analysis, the truss bridge fabrication and the design assumption taken was relatively correct.

The group also discusses the advantages of aluminum as a construction material for the truss bridge. Aluminum is chosen for its high strength-to-weight ratio and high corrosion resistance. By integrating theoretical design principles, advanced software modeling, precise fabrication techniques, and experimental analysis the group have achieved a significant understanding of design, fabrication and performance of aluminum truss bridges. Moreover, the group have learned the theoretical design analysis, the importance of advanced finite element modeling and the challenges of practical fabrication of the truss bridge. The truss members are connected using only one bolt and this makes the fabrication processes more challenging, specially at the locations where more than two members meet.

Reference

1. *Aluminum 6082-T6. (n.d.). Retrieved March 26, 2023, from*
<https://matweb.com/search/DataSheet.aspx?MatGUID=fad29be6e64d4e95a2416901f6e1eb7&ckck=1>
2. *Arun, L., Sarangapani, G., & Prasanna, H. S. (2021). Characteristics Of High Strength Stone Masonry Using Cement-Soil Mortar. Turkish Journal of Computer and Mathematics Education, 12(10), 3826–3841.*
3. *Brekke, C. A. R. (2017). Concept Development of an Aluminum Pedestrian Bridge. NTNU. <http://hdl.handle.net/11250/2456873>*
4. *Das, S. K., Kaufman, J. G., & Road, B. L. (n.d.). ALUMINUM ALLOYS FOR BRIDGES AND BRIDGE DECKS.*
5. *EN 1999-1-1:2007+AI:2009. (2009). Eurocode 9: Design of aluminium structures. Part 1-1: General structural rules: Del 1-1: General structural rules: Vol. NS-EN 1999-1-1:2007+AI:2009.*
6. *Enevoldsen, I., Pedersen, C., Axhag, F., Johansson, Ö., & Töyrä, B. (2002). Assessment and Measurement of the Forsmo Bridge, Sweden. Structural Engineering International, 12(4), 254–257. <https://doi.org/10.2749/101686602777965117>*
7. *Eurocode 3—Design of steel structures—Part 1-5 Plated. (n.d.).*
8. *Gao, S., Yang, H., & Liu, J. (2020). Modeling and distributed adaptive fault-tolerant vibration control for bridge beam with single-parameter adaptive neural network. International Journal of Adaptive Control and Signal Processing, 34(12), 1831–1846. <https://doi.org/10.1002/acs.3179>*
9. *Kaczmarczyk, J. (2019). Modelling of Guillotine Cutting of a Cold-Rolled Steel Sheet. Materials, 12(18), Article 18. <https://doi.org/10.3390/ma12182954>*

10. Lin, W., & Yoda, T. (2017a). *Chapter Eight—Truss Bridges*. In W. Lin & T. Yoda (Eds.), *Bridge Engineering* (pp. 137–153). Butterworth-Heinemann.
<https://doi.org/10.1016/B978-0-12-804432-2.00008-6>
11. Lin, W., & Yoda, T. (2017b). *Chapter Four—Loads and Load Distribution*. In W. Lin & T. Yoda (Eds.), *Bridge Engineering* (pp. 71–83). Butterworth-Heinemann.
<https://doi.org/10.1016/B978-0-12-804432-2.00004-9>
12. Mezei, K. (1985). *A Bridge of Sorts: The Translation of Quebec Literature into English*. *The Yearbook of English Studies*, 15, 201–226.
<https://doi.org/10.2307/3508555>
13. Ozyhar, T., Hering, S., & Niemz, P. (2012). *Moisture-dependent elastic and strength anisotropy of European beech wood in tension*. *Journal of Materials Science*, 47(16), 6141–6150. <https://doi.org/10.1007/s10853-012-6534-8>
14. Roberge, P. R. (2000). *Handbook of corrosion engineering*. McGraw-Hill.
15. USA TRB NCHRP. (2004). *Concrete bridge deck performance (Vol. 333)*. TRB.
http://onlinepubs.trb.org/Onlinepubs/nchrp/nchrp_syn_333.pdf
16. Vargel, C. (2004). *Corrosion of Aluminium (1st ed., English ed.)*. Elsevier.
<https://doi.org/10.1016/B978-0-08-044495-6.X5000-9>
17. Warrian, P. (2016). *A Profile of the Steel Industry: Global Reinvention for a New Economy, Second Edition*. Business Expert Press.
18. Weiwei, L., & Yoda, T. (2017). *Bridge Engineering—Classifications, Design Loading, and Analysis Methods*. Elsevier.
19. Wen, Q.-J., & Yue, Z.-X. (2020). *Elastic buckling property of the upper chords in aluminum half-through truss bridges*. *Structures (Oxford)*, 27, 1919–1929.
<https://doi.org/10.1016/j.istruc.2020.07.057>

Appendix

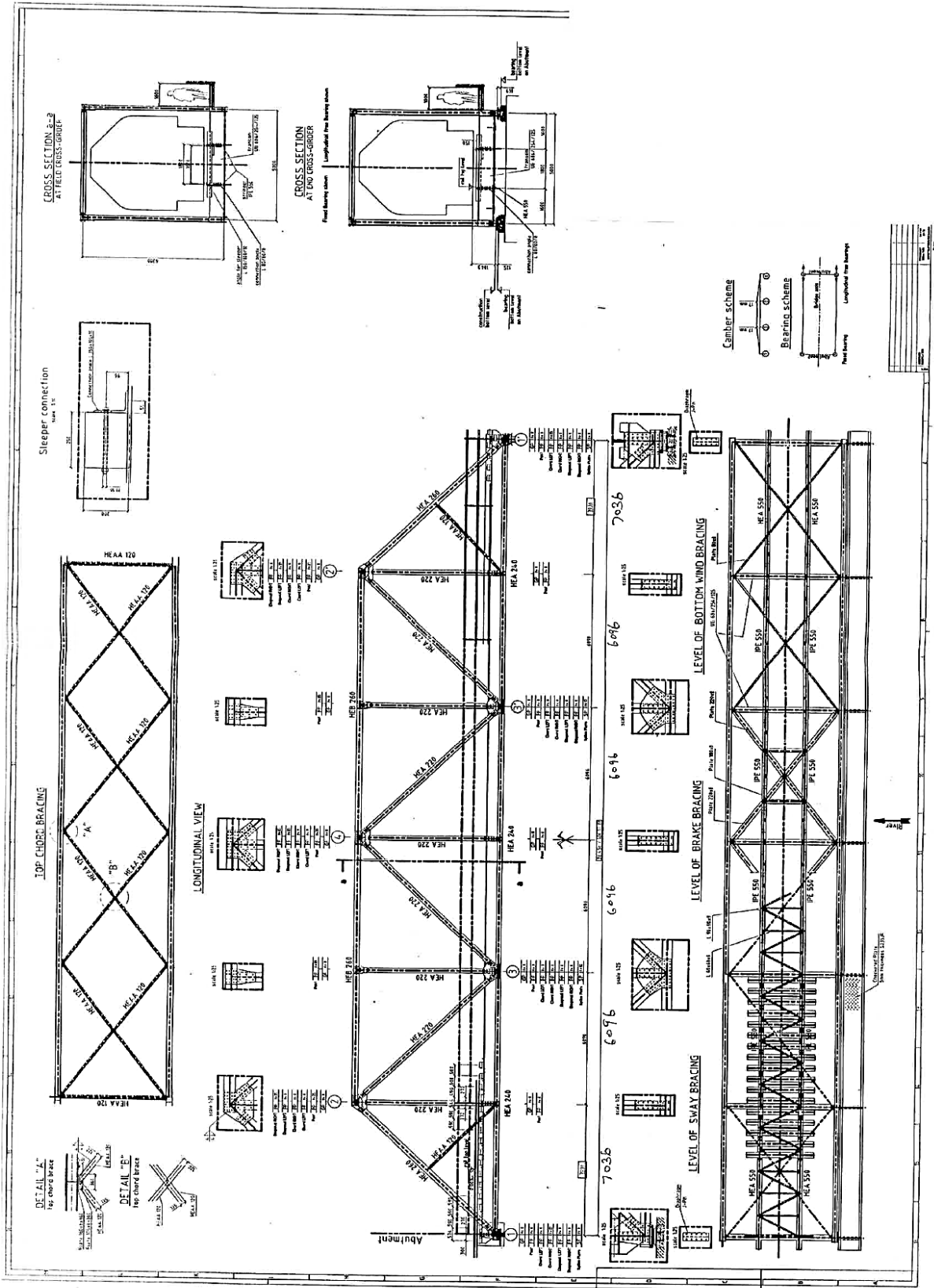

Customer P.O. No	PO 1715970(PFI 3515)	Transporter Description	WESTERN CARRIERS (INDIA) LIMITED			
Sales Order	2208050200453	Commercial Invoice No & Date	RFG/R/2023/557	07-SEP-22	Truck/Container No	MSMU4401332

Product Description: D-AA1050-H14-2500-1250-1-TL-N-N-N-N-N-0-NR-STANDARD-Rolled Sheets

CERTIFICATE CONFORMS TO : PROVISIONAL

Sr No	Lot Number	Coil Number	Cast Number	Alloy	Temper	Thickness(mm)	Width(mm)	Length(mm)	Net Wt(MT)
1	2S220512620	E00220/1/2	22S1050-89-01/8	AA1050	H14	1	1250	2500	1.081
2	2S220512697	E00217/1	22S1050-89-01/4	AA1050	H14	1	1250	2500	1.078
3	2S220512698	E00217/2	22S1050-89-01/4	AA1050	H14	1	1250	2500	1.082
4	2S220512737	E00220/E/1	22S1050-89-01/8	AA1050	H14	1	1250	2500	1.076
5	2S220512865	E00219/1	22S1050-89-01/6	AA1050	H14	1	1250	2500	1.078
6	2S220512866	E00219/2	22S1050-89-01/6	AA1050	H14	1	1250	2500	1.075
7	2S220512867	E00219/3	22S1050-89-01/6	AA1050	H14	1	1250	2500	1.077
8	2S220512868	E00219/4	22S1050-89-01/6	AA1050	H14	1	1250	2500	1.073

CHEMICAL COMPOSITION (%)

Cast No.	Si	Fe	Cu	Mn	Mg	Cr	Zn	Ti	B	Bi	Pb	Sn	V	Zr	Others (Total)	Aluminium (Minimum)
Standard Values Min																
Standard Values Max																
1	-															
2	22S1050-89-01/4	0.109	0.316	0.004	0.005	0.002	0.001	0.002	0.016		0.002					99.5100
3	22S1050-89-01/6	0.109	0.316	0.004	0.005	0.002	0.001	0.002	0.016		0.002					99.5100
4	22S1050-89-01/8	0.109	0.316	0.004	0.005	0.002	0.001	0.002	0.016		0.002					99.5100

MECHANICAL PROPERTIES

OTHER TESTS

Lot Number	UTS MPa	%Elongation on 50 mm GL	0.2% Proof Stress MPa	Bend Test (t)	ECV Value mm	% Earing	% Conductivity	Grain Size
Standard Values Min								
Standard Values Max								
1	2S220512620	117	8	112	0			5
2	2S220512697	118	6	112	0			5
3	2S220512698	118	6	112	0			5
4	2S220512737	117	8	112	0			5
5	2S220512865	121	5	112	0			4
6	2S220512866	121	5	112	0			4
7	2S220512867	121	5	112	0			4
8	2S220512868	121	5	112	0			4