



University
of Stavanger

**EKATERINA DEGTYAREVA (9012),
MERCEDES HIDALGO ACOSTA (9009)**
SUPERVISOR: SIRI VALSETH

The European energy crisis and its influence on financial markets

Master thesis, 2023

Master of Science in Business Administration

University of Stavanger Business School

Specialization: Applied Finance



Contents

Acknowledgments.....	4
Abbreviations.....	5
Abstract.....	6
1. Introduction.....	7
1.1 Motivation behind the research.....	7
1.2 Research questions.....	8
1.3 Research approach.....	9
1.4 The structure of the study.....	9
2. Theoretical framework and literature review.....	10
2.1 Brief review of the literature.....	10
2.2 The theory behind the research.....	12
3. The European energy market.....	15
3.1 The European energy mix.....	15
3.2 European energy import.....	16
3.3 Energy shocks.....	17
4. Methodology and data.....	19
4.1 Data description and summary statistics.....	19
4.1.1 INDEXes data.....	19
4.1.2 Energy data.....	22
4.1.3 Industrial production and Interest rate data.....	25
4.2 Methodology.....	27
4.2.1 VAR approach.....	27
4.2.2 DLM approach.....	29
5. Empirical results.....	30
5.1 VAR framework and results.....	30
5.1.1 Joint Hypothesis Testing.....	30
5.1.2 Variance decomposition analysis and impulse response function.....	32
5.1.3 Granger-causality analysis.....	39
5.2 DLM framework and results.....	42
6. Interpretation and discussion.....	51
7. Conclusions.....	56
8. Future work.....	57
References.....	58
Appendices.....	62
Appendix 1. The details about chosen INDEXes.....	62

Appendix 2. Descriptive statistics of INDEXes in level (2008.09 - 2023.01).	65
Appendix 3. The dynamics of stock index return.	66
Appendix 4. Descriptive statistics of fossil fuel prices in level (2008.09 - 2023.01).....	68
Appendix 5. Descriptive statistics of IR in first differences (2008.09 - 2023.01).....	69
Appendix 6. Results of the partial autocorrelation study	66
Appendix 7. Impulse response function of IPI growth to INDEXes.....	70
Appendix 8. Impulse response function of IR growth to INDEXes.....	71
Appendix 9. Results of the Granger causality tests	72
Appendix 10. Results of the DLM regressions	76

Acknowledgments

This master's thesis has been performed at the University of Stavanger Business School, Norway, under the supervision of Associate Professor in Finance Siri Valseth during the spring term of 2023. We would like to express special gratitude to Siri for supervising us during this work, providing constructive feedback and discussions, and giving us useful tips.

We also appreciate all the passion and enthusiasm for Data Analysis using R shared with us by Professor Tom Broekel.

We are grateful for all the learning opportunities provided by the University of Stavanger, especially for giving us access to tremendous financial market data and infrastructure through REFINITIV. This thesis would never have been completed without high-quality, high-frequency financial data downloaded from REFINITIV.

We would like to thank our family members for their support, patience, and informal feedback.

Abbreviations

DAX – the stock market index of Germany, which includes 30 largest companies listed on the Frankfurt Stock Exchange.

CAC 40 – the stock market index of France, which includes top 40 companies listed on the Euronext Paris exchange.

FTSE 100 – the stock market index of the UK, which includes 100 largest companies listed on the London Stock Exchange.

OBX – the stock market index of Norway, which includes 25 most active stocks listed on the Oslo Stock Exchange.

BEL 20 – the stock market index of Belgium, which includes the top 20 companies listed on the Brussels stock exchange.

FTSE MIB – the stock market index of Italy, which includes the 40 most actively traded companies listed on the Borsa Italiana.

OMXCPI – the stock market index of Denmark, which includes the 25 most actively traded stocks on the Copenhagen Stock Exchange.

AEX – the stock market index of the Netherlands, which includes the 25 most actively traded companies listed on the Amsterdam Stock Exchange.

INDEX(es) – the common definition of all countries' indexes above.

GAS – the Title Transfer Facility (TTF) natural gas commodity future contracts traded at the TTF Virtual Trading Point.

OIL – the Europe Brent Crude Electronic Energy future traded electronically on the ICE (Intercontinental Exchange) Futures Europe exchange.

COAL – the API 2 (Argus/McCloskey Coal Price Index) futures coal assessment traded on the ICE Futures Europe exchange.

IPI – Industrial Production Index as a percentage year on year, seasonally adjusted, relative to a base year 2010=100.

IR – Interest rate, which measured using the Long-Term Government Bond Yields, 10-Year, main (including benchmark).

VAR model - Vector Autoregressive model.

DLM - Dynamic linear regression model.

D1 – dummy variables, which represent the pre-invasion period (starts on February 23, 2021, and lasts for one year).

D2 – dummy variables, which represent the post-Russian invasion of Ukraine period (from February 24, 2022, to January 31, 2023).

Abstract

The last two global events that shook the economy of Europe, namely the COVID-19 pandemic and Russian invasion of Ukraine, served as motivation to apply financial knowledge and research the relationships between the current energy crisis and financial markets. Earlier studies were mainly focused on the relationships between oil prices and their impact on the macroeconomy and financial markets. Gas, in turn, did not receive as much attention due to European companies entering into long-term gas supply contracts and hedging their risks. As a result, the disruption of these supplies caused an unprecedented energy crisis, the effects of which are investigated in this thesis.

This study analyzes the impact of energy price movements on European stock markets from 2008 to 2023 using monthly data extracted from REFINITIV and FRED economic databases. We used for analysis the VAR model, which is a widely applied empirical tool for financial modeling, as well as the DLM approach. The models include eight European stock market INDEXes, GAS, OIL, COAL, IPI, and IR.

According to the results, stock markets currently show low rationality in the short term, which means that INDEXes do not always reflect the true value of companies and that the volatility of stocks is mainly linked to speculation, emotional decision-making, and incomplete information. Depending on the specificities of the economies of the analyzed countries and their dependence on gas imports, financial markets react differently to GAS shocks. OIL is currently less significant than GAS due to the extraordinary GAS shock. We have proven the impact of GAS on INDEXes in Germany and France through a direct channel due to a high level of dependence on the import of fossil fuels, and in Norway and Italy through an indirect (monetary) channel.

1. Introduction

1.1 Motivation behind the research

The economic repercussions of the Russian invasion of Ukraine represent yet another significant setback for the world economy. For nations still recovering from the COVID-19 pandemic, the level of disruptions to supply chains and commodities markets will have a significant impact on macro-financial stability and growth. The Russian invasion of Ukraine is expected to prolong the rise of inflation, which has already occurred in many countries due to supply-demand imbalances during the pandemic. Emerging markets and developing economies are under pressure due to tighter financial conditions, rising borrowing rates, and the possibility of capital outflows.

European sanctions against Russia and Russian withholdings of gas supplies have become the basis for an unprecedented energy crisis in Europe. Although energy prices have risen significantly around the world, Europe has been suffering more than other regions because of its historical dependence on Russian gas.

The current market conditions are significantly affected by two events. During COVID-19, oil and gas prices dropped significantly due to a lack of demand, as the global economy was slowing down as a result of lockdowns introduced everywhere in the world. In order to sustain the oil and gas business, the major producing companies agreed to reduce supply, trying to control energy prices. The post-pandemic world experienced a shortage of oil and gas supply, which resulted in gas price shocks, especially in Europe. With the Russian invasion of Ukraine, the situation became even worse as the EU agreed to stop importing oil and gas from Russia.

This thesis focuses on its contribution to previously published studies regarding the relationships between energy prices and stock markets. We aim to contribute in the following ways. Firstly, the effect of natural gas prices on stock market prices has not been exhaustively examined. Most studies had focused on oil shocks (Acaravci et al., 2012). In our case, we expect the response from gas shocks to be more significant than from oil shocks for the 2022–2023 time frame. We believe this is because the current energy crisis is driven by a gas supply shortage. However, as there is a strong correlation between oil and gas prices (Villar & Joutz, 2016), our beliefs may be challenged. Moreover, it is a fact that Europe is currently experiencing an extraordinary shortage in gas imports, which may affect the stock market even worse than other historical shocks examined in previous studies. On the other hand, our research

is unique in the sense of the chronological order of recent global events, namely COVID-19 and the Russian invasion of Ukraine. So far, there are no detailed studies that examine the effects of the current energy crisis in Europe from the financial market's perspective.

1.2 Research questions

In our thesis we investigate the following questions. Firstly, this study examines the relationships between energy prices and stock market movements in the major European fossil fuel exporting and importing nations. For this purpose, we investigate the possible impact of energy prices on stock markets and vice versa. We analyze GAS, OIL, and COAL (fossil fuels) prices. We have chosen countries that have the largest stock markets in Europe and are the largest fossil fuel importers and exporters. The fossil fuel importing countries are Germany, France, Belgium, and Italy. Denmark, the UK, and the Netherlands are oil- and gas-producing countries; nevertheless, they are dependent on fossil fuel imports from abroad. The net fossil fuel exporting country is Norway, which is one of the major gas suppliers to Europe. We run an empirical analysis to see if all INDEXes exhibit a similar response to changes in energy prices. Moreover, we test whether stock market movements can be predicted by energy price shocks by using the impulse response function.

Our second objective is to evaluate the rationality of stock markets by examination of various factors that could impact them. Specifically, we aim to assess the potential direct and indirect connections between energy prices and INDEXes. We have identified two key expectations. Firstly, fossil fuel prices have a direct impact on each of the stock markets investigated in the study. Secondly, the changes in fossil fuel prices impact stock returns through indirect channels, which theoretically speaking should affect stock market movements. In our thesis, we investigate two indirect channels, namely the monetary channel (interest rates) and the output channel (industrial production). If fundamental factors such as changes in commodity prices and macroeconomic indicators underlie stock market movements, then we confirm the concept of rationality of stock markets.

The last question of our research is to investigate whether the Russian invasion of Ukraine has affected the relationship between energy markets and stock markets. This analysis will allow us to identify several aspects: first, if the invasion has influenced the financial markets; second, if the importance of gas has decreased after the invasion, considering the decrease in gas consumption in Europe and the termination of contracts with Russia.

1.3 Research approach

According to the asset pricing literature, the conventional technique to estimate the impact of energy price volatility on stock markets is to employ a standard market model supplemented by the energy price and certain other parameters. In our study, we implement VAR model, and DLM.

Using the VAR model and impulse response is a widely accepted procedure to investigate the relationships between energy prices and stock returns (Huang et al., 1996; Sadorsky, 1999; Scholtens & Yurtsever, 2012). In our study, we examine how energy prices' movements and stock returns influence each other during the sample period, from September 2008 to January 2023.

Using the DLM helps us analyze the relationships between the stock market and various variables in a dynamic and time-varying manner. DLM provides a flexible framework that enables the inclusion of lagged variables, dummy variables, and interaction terms. By doing so, we aim to gain insights into how these factors relate to the stock market, particularly before and after the Russian invasion of Ukraine.

The main analyzed variables are stock INDEXes of eight European energy exporting and importing countries and GAS, OIL, and COAL. Furthermore, we introduce some control variables that can help to understand the effect of energy prices on stock returns. Since GAS is not the major factor that would affect stock prices, a control of macroeconomic variables in the empirical models is a general approach. The control variables are chosen based on the assumption that they might cause movements in the stock return, as previous studies confirmed. The dummy variables in the DLM model represent the different periods under investigation.

The models include a monetary sector by including interest rate as control variable, which may react to inflationary pressures (Degiannakis et al., 2018; Sadorsky, 1999; Scholtens & Yurtsever, 2012). The second control variable is IPI. Previous studies concluded that a growth in the level of industrial production positively impacts the share price (Sadorsky, 1999; Wongbangpo & Sharma, 2002).

1.4 The structure of the study

The rest of the thesis is structured as follows. Section 2 describes the theoretical framework and literature review behind the research. Section 3 provides an overview of the European energy

market, with a specific focus on GAS. We describe the dependence of European countries on fossil fuel sources and the nature of the current energy crisis using statistics. Section 4 examines the time series properties of the data, analyzes the descriptive statistics of variables, and presents a multivariate VAR model and DLM analysis using monthly data from 2008 to 2023. Section 5 presents the empirical results, reports the dynamic effects of shocks, and compares the findings with those of other authors. Section 6 offers an interpretation and discussion of the results and addresses the limitations of the model. Section 7 concludes by summarizing the results and discussing their implications. Finally, Section 8 suggests possible directions for future research.

2. Theoretical framework and literature review

2.1 Brief review of the literature

Almost all the previous publications can be divided into two groups. The first group of studies is investigating the influence of fossil fuel prices on macroeconomic indicators such as GDP, inflation, unemployment, etc. (Al-hajj et al., 2018; Alpanda & Peralta-Alva, 2010; Barsky & Kilian, 2004; Hamilton, 2003; Olubusoye et al., 2021). The second group is investigating relations between fossil fuel prices and stock markets (Antonakakis et al., 2017; Atif et al., 2022; Bouri, 2015; Ghorbel & Jeribi, 2021; Huang et al., 1996; Jiang & Yoon, 2020).

A majority of the publications investigated historical oil crises and oil price shocks. It seems only a few authors have attempted to investigate the relevance of gas prices to financial markets (Acaravci et al., 2012; Ahmed, 2018; Gatfaoui, 2016; Lin et al., 2019).

A wide variety of empirical methods were deployed to understand relations between energy prices and financial assets, including, for instance, VAR models (Antonakakis et al., 2017; Atif et al., 2022; Degiannakis et al., 2018; Huang et al., 1996; Jiménez-Rodríguez & Sánchez, 2005), GARCH methodology (Ahmed, 2018; Bouri, 2015; Creti et al., 2013; Ghorbel & Jeribi, 2021; Kumar et al., 2019; Lin et al., 2019), OLS regression model (Ahmed, 2018), wavelet analysis (Jiang & Yoon, 2020; Khalfaoui et al., 2015; Khan et al., 2022; Mensi et al., 2021), cointegration analysis (Acaravci et al., 2012; Nath Sahu et al., 2014; Park & Ratti, 2008).

The pioneer studies that investigated the effects of oil prices on the macroeconomy using VAR models are Hamilton (1983) and Burbidge & Harrison (1984). Huang et al. (1996) used a VAR approach to test the relationships between oil futures returns and stock returns. Through the

VAR model, Sadorsky (1999) proved that oil prices play an important role in affecting real stock returns. The latest studies use different variations of VAR models, i.e., Structure VAR models and Panel VAR models, to investigate the relationships between oil shocks and stock markets (Antonakakis et al., 2017; Atif et al., 2022).

The main findings of earlier studies may be summarized as follows. They have found a linear negative relationship between energy prices and real activity in oil importing countries (Burbidge & Harrison, 1984; Gisser & Goodwin, 1986; Hamilton, 1983; Rasche & Tatom, 1981). All these studies focused on developed countries such as the US, Japan, Germany, the UK, Canada, France, Italy, and the Netherlands. It seems the significance of the assumed linear relationship between oil prices and a real country's activity started to diminish in the middle of the 1980s. From this period, some authors found evidence of a non-linear relationship between energy prices and GDP (Hamilton, 2003; Jiménez-Rodríguez & Sánchez, 2005). Hamilton (2003) have found that rises and drops in oil prices do not have the same significance for estimating GDP and increases are more relevant for forecasting. In earlier volatility periods, oil price changes were less useful for predicting GDP. In the case of the Malaysian market, the findings showed there is a long run asymmetric link between oil price shocks, interest rates, exchange rates, industrial production, inflation, and stock market returns; almost all sectors are cointegrated (Al-hajj et al., 2018). Some researchers have found that oil price fluctuations are expected to have less of an impact on macroeconomic health, contrary to popular belief (Barsky & Kilian, 2004).

As a number of papers suggest, there is a link between energy prices and the stock market (Acaravci et al., 2012; Antonakakis et al., 2017; Atif et al., 2022; Bouri, 2015; El et al., 2010; Ghorbel & Jeribi, 2021; Jiang & Yoon, 2020; Mensi et al., 2021), while some authors (Huang et al., 1996) found no evidence of relationships between oil prices and market indexes. The analysis of the stock market crash of 1973–74 indicates that although other factors were certainly at play, the increase in energy prices was indeed an important contributor (Alpanda & Peralta-Alva, 2010). Stock prices are more influenced by oil prices in oil-exporting countries than in oil-importing countries, where stock prices are linked to oil prices only during financial crises (Jiang & Yoon, 2020). When it comes to EU countries, empirical findings suggest that there is a unique long-term equilibrium relationship between natural gas prices, industrial production, and stock prices in Austria, Denmark, Finland, Germany, and Luxembourg, while no relationships is found in the other ten EU-15 countries (Acaravci et al., 2012).

After the oil price crash owing to the COVID-19 pandemic, the interdependence between oil and stock price changes increased. Even though both oil exporting and oil importing countries were affected in a similar way, oil price changes had a larger impact on oil exporting countries (Atif et al., 2022). G7 stock indexes have a high level of dynamic correlation with energy assets, which proves the contagion effect of COVID-19 (Ghorbel & Jeribi, 2021).

2.2 The theory behind the research

Since the first major energy crisis in 1970, a lot of studies have been done and published to investigate the relationships between energy prices and financial assets.

Many researchers point out that fossil fuel prices have considerable consequences for economic activity, which differ depending on whether a country imports or exports fossil fuels (Jiménez-Rodríguez & Sánchez, 2005). An increase in fossil fuel prices is generally considered good news in oil and gas exporting countries, but it is bad news in oil and gas importing countries; the opposite is true for cases when prices go down. Both supply and demand channels must be considered when assessing the impact of fossil fuel prices on real economic activity.

The supply side effects are related to the fact that crude oil is a basic input to production, as is gas, which provides energy means for production. An increase in oil and gas prices leads to a rise in production costs, which can result in companies lowering output. Oil and gas price changes can also have demand effects on consumption and investment, with reduced income indirectly affecting consumption. The order of this effect becomes more visible and stronger as long as the shock is perceived to be long-lasting.

As mentioned earlier, an increase in oil and gas prices leads to an increase in production costs, which changes the expected cash flow positively or negatively, depending on whether the company is an oil and gas consumer or producer (Mohanty & Nandha, 2011; Oberndorfer, 2009). If the stock market is rational, economic theory highlights that the stock price reflects the discounted future cash flows of a particular stock (Degiannakis et al., 2018), which can be defined by the following formula:

$$P_{i,t} = \sum_{n=t+1}^N \left(\frac{E(CF_n)}{(1 + E(r))^n} \right) , \quad (1)$$

where P is stock price, CF_n is the cash flow at time n and r is the discount rate. $E(\cdot)$ denotes the expectation operator.

Logarithmic (continuously compounded) return may be defined as:

$$R_{it} = \ln \left(\frac{P_{it}}{P_{it-1}} \right), \quad (2)$$

where R is logarithmic return, $\ln(\cdot)$ is the natural log function in month t .

For an energy-consuming company, fossil fuels are one of the major production inputs, and thus an increase in prices will result in an increase in production costs. This will reduce profit levels, and future cash flows will be negatively affected (Bohi, 1991; Filis, 2010). At the same time, for an oil and gas producing company, an increase in the price of fossil fuel will lead to an increase in profit margins and consequently increase the expected cash flows. It is fair to assume that oil and gas users exhibit bearish behavior during periods of energy price increases. It is expected that the stock price and stock returns will react accordingly.

Generally speaking, an increase in production costs leads to higher retail prices, which in turn increases expected inflation (Hamilton, 1996). This is because the increased production costs are passed on to consumers. Additionally, it is expected that interest rates will increase as a response to higher inflationary pressures (Basher & Sadorsky, 2006). Consequently, an increase in interest rates affects the discount rate for companies' investments, raising their borrowing costs. Eventually, the number of positive net present value (NPV) projects decreases due to higher discount rates. Finally, due to increased discount rates and/or lower cash flows, the value of stock prices decreases.

An increase in oil and gas prices tends to lower the discretionary income of households due to changes in retail prices resulting from increased production costs. Moreover, the prices of gasoline and heating oil increase as well (Edelstein & Kilian, 2009). The reduction in income leads to lower consumption and aggregate output, resulting in lower labor demand. In other words, an increase in oil and gas prices worsens the terms of trade for an oil-importing economy, leading to lower income and a negative wealth effect on consumption, ultimately resulting in lower aggregate demand. Usually, stock markets react negatively to such trends.

Microeconomic concepts can be used to illustrate the impact of rising energy prices on both fossil fuel exporting and importing countries for the whole economy (Figures 1 and 2), the pictures are adapted from Filis & Chatziantoniou (2014).

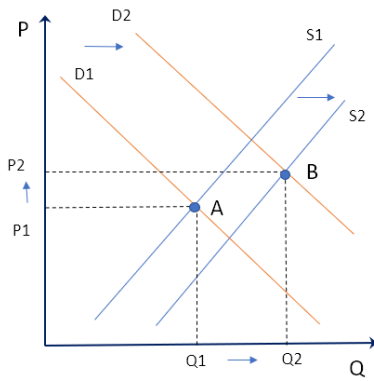

Figure 1. The effect of energy price increase on fossil fuel exporting countries

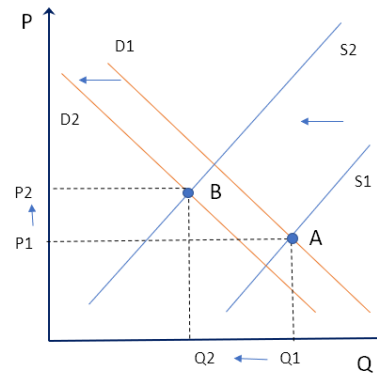

Figure 2. The effect of energy price increase on fossil fuel importing countries

Q – Output /quantity, P – Price for fossil fuel, S – Supply, and D – Demand.

In Figure 1, the impact of a positive change in energy prices is highlighted for an economy that exports fossil fuels. This change leads to two opposing forces. Firstly, higher energy prices result in increased production costs, which shift the S curve to the left. However, higher energy prices also lead to greater disposable income and faster economic growth, causing both the D and S curves to shift to the right (to D2 and S2). In fossil fuel exporting economies, the income effect is typically larger than the production effect, resulting in an increase in aggregate output from Q1 to Q2. As a result of the shifts in the D and S curves, the income in fossil fuel exporting countries has also increased.

In Figure 2, the impact of a rise in energy prices on a fossil fuel importing economy is shown. The increase in energy costs leads to a reduction in disposable income, resulting in a negative income effect and causing the D curve to shift to the left (from D1 to D2). Additionally, production effects cause the D curve to shift even further to the left due to increased retail prices, leading to decreased consumption. The S curve also shifts to the left (from S1 to S2) due to higher production costs. These shifts in the D and S curves result in cost-push inflation, causing a movement from price levels P1 to P2, and a reduction in Output from Q1 to Q2. As a result, the fossil fuel importing economy experiences a decrease in income.

3. The European energy market

3.1 The European energy mix

According to Eurostat (EU Statistics agency), Figure 3, the EU energy mix in 2020 consisted of 34.5% oil and petroleum products, 23.7% natural gas, 17.4% renewables, 12.7% nuclear energy, and 10.5% coal. Therefore, almost 70% of European energy needs were provided by fossil fuels, i.e., non-renewable hydrocarbon-containing materials formed naturally by the Earth. That mainly includes coal, natural gas (and liquefied natural gas called LNG), oil, and oil products.

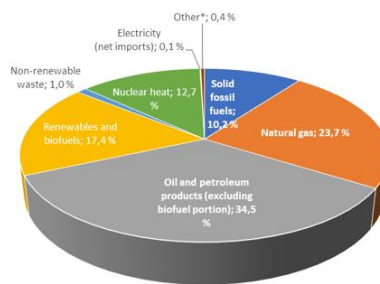

Figure 3. European Energy mix (in petajoules) in 2020. Source: Eurostat, 2022

The European energy mix has been varied over the last few decades. Figure 3 represents the historical EU's gross available energy (imported and locally produced) in terms of fuel. A major observation is that both oil products and natural gas have been steadily decreasing since 2006, while renewables are continuing their long-term upward trend.

Also, general trends in Figure 4 show efforts on an EU scale to reduce CO₂ emissions to zero (decarbonization) for the energy system. That creates a lot of uncertainty with respect to the future of nuclear energy, which is currently under pressure from Environmental regulations and “green” waves. At the same time, following the challenges of climate change, demand for clean renewable energy sources is expected to grow. However, in terms of investment, it might take another few years before cost-efficient solutions for renewable energy sources will be introduced, which might theoretically replace fossil fuels. Therefore, in our thesis, we would like to deliberately focus on fossil fuel analysis, especially natural gas.

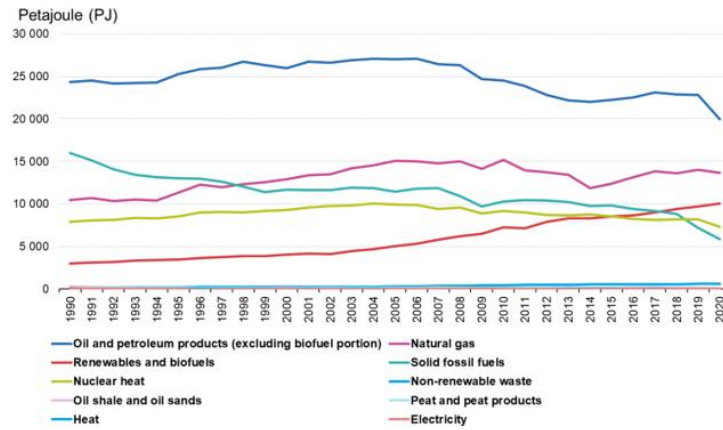

Figure 4. EU Gross available energy by fuel, 1990-2020. Source: Eurostat

3.2 European energy import

Historically, Europe has been a major energy importer. For instance, in 2020, the EU imported 57.5% of the energy it consumed, while the rest of its needs were covered by local production.

The EU's dependency on its energy imports has increased over time. First, production trends have changed, and second, consumption has been steadily increasing due to economic growth. The lowest value of import dependency was observed in 1990 (50.0%), with the peak registered in 2008 (58.4%) and a record high in 2019 (60.5%). Figure 5 shows historical data on EU import dependencies, i.e., how much the EU depends on imports from abroad. The graph shows the share of net imports in the gross available energy for the region. Import dependency is calculated as imports minus exports divided by gross available energy.

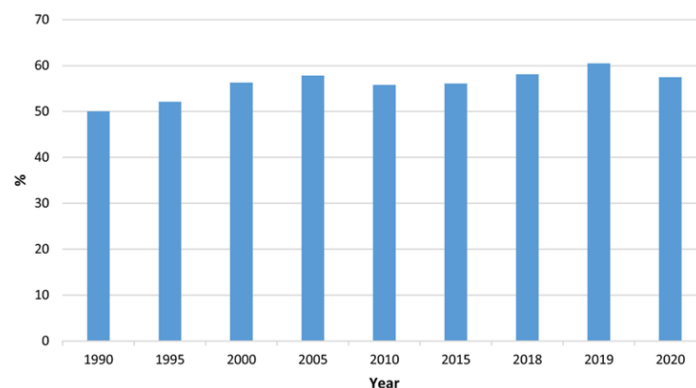

Figure 5. Dependency of EU on energy imports, 1990–2020, %.

Source: Authors based on Eurostat

Since the major objective of the thesis is to test the relationships between gas prices and stock markets, it is essential to highlight the gas import dependency for both the EU and individual

countries. According to Eurostat data published for 2020, the EU imported up to 84% of natural gas meaning only 16% was produced locally. Figure 6 represents natural gas import dependencies for most of the countries in the EU. From the plot below, it seems the country most dependent on gas imports in the EU is Belgium (99%).

The listed countries (except for the UK) are highlighted in red in the plot below, confirming significantly high import dependence for Belgium (99%), Germany (89%), France (95%), and Italy (93%). Even though Denmark and the Netherlands are oil- and gas-producing countries, they still depend on imports from abroad at 37% and 45%, respectively. It might be explained by the fact that there have been no major gas field discoveries recently made on the Danish and Dutch North Sea Continental Shelf (NCS). That makes existing major fields depleted even further with declining gas production. Another active country on the NCS is Norway, which is a major net exporter in the region (-2031%).

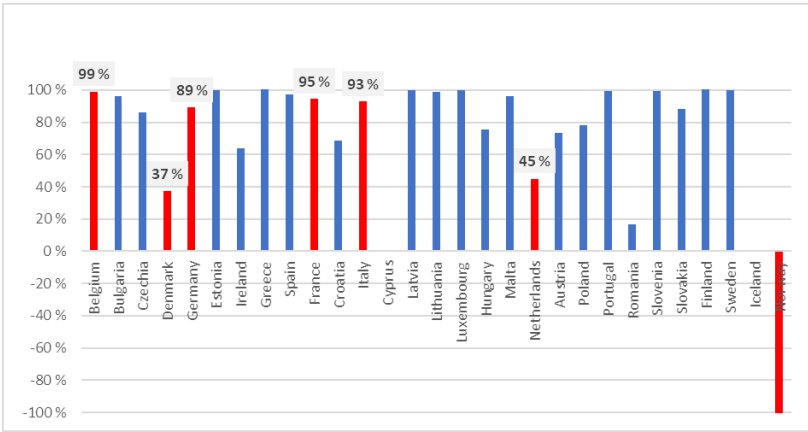

Figure 6. Natural Gas Import Dependency within European Countries.

Source: Authors based on Eurostat

3.3 Energy shocks

The energy market had several shocks over the period of our analysis. One of the biggest events on a global scale was Global Financial Crisis in 2008, which resulted in a significant drop in all fossil fuel prices. It took more than 2 years for oil and coal prices and more than 5 years for gas prices to recover to pre-crisis levels.

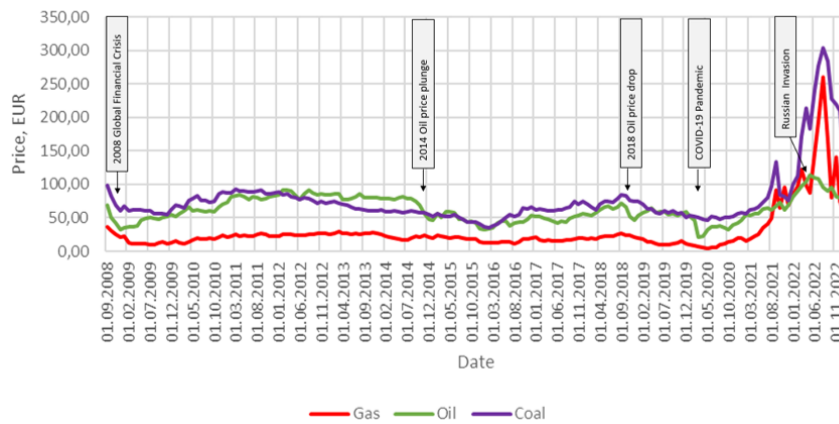

Figure 7. Energy prices and shocks

Figure 7 shows that after peaking at 79.4 EUR a barrel at the end of June 2014, oil prices dropped to as low as 36.4 EUR a barrel by the end of January 2015. Between 2014 and 2016, the global economy experienced the biggest decline in energy prices in modern history. That drop was primarily driven by supply factors, including the booming oil production in the US. A significant oil price change had also dragged down gas prices. The gas price dropped from around 20 EUR by the end of 2014 to 7 EUR in August 2016.

Another big energy shock happened in 2018, when both oil and gas prices declined by more than 30% over one month. That was the biggest 30-day drop since 2008. The major reason behind the significant drop is believed to be supply related. The three big energy market players – Russia, the United States, and Saudi Arabia – ramped up oil and gas production at that time.

The first quarter of 2020 was yet another massive demand shock for global energy markets. Due to the COVID-19 pandemic and all the restrictions introduced by governments all around the world, all energy prices dropped significantly. With social distancing reducing movement and almost no daily travel, the oil and gas industry has been under pressure like never before. Also, the pandemic overall resulted in a deep global economic downturn.

The most recent shock energy markets experienced was significant gas price fluctuations in 2022, which were directly impacted by the Russian invasion of Ukraine. With the Russian Federation being the largest gas importer to Europe (before the invasion), the supply side of things was put at risk, which drove a significant price increase for the Title Transfer Facility (TTF, European gas price). Following sanctions against the Russian Federation combined with cold winter expectations for Europe resulted in a further price increase until alternative gas import routes to Europe had been introduced.

The post-shock (in 2022) market can be described by mild winter weather in the northern hemisphere, which eased some pressure on the demand side of things. On top of that, with LNG inflows becoming more sustainable and appropriate gas storage inventories becoming available, pressure on European and Asian gas prices has been released.

4. Methodology and data

4.1 Data description and summary statistics

The empirical period starts on September 30, 2008, and ends on January 31, 2023. The data for each country consists of 3,654 monthly observations. The stock prices, GAS, OIL, and COAL, and IPI are obtained from REFINITIV. The data for IR is downloaded from FRED economic data. We chose to investigate monthly data because our control variable, IPI, has a monthly basis. The data are denominated in EUR.

4.1.1 INDEXes data

We collected adjusted closing-price data for eight European stock market INDEXes for oil-importing and oil-exporting countries, namely, Germany (DAX), France (CAC 40), the UK (FTSE 100), Norway (OBX), Belgium (BEL 20), Italy (FTSE MIB), Denmark (OMXCPI), and the Netherlands (AEX). Details about the chosen INDEXes are presented in Appendix 1. The literature served as the motivation for selecting these countries. Empirical studies demonstrate that a nation's ability to absorb oil price shocks depends on whether it is a net oil exporter or importer (Atif et al., 2022; Bouri, 2015; Degiannakis et al., 2018; Jiang & Yoon, 2020).

The adjusted closing-price data are transformed into logarithmic (continuously compounded) price returns and defined by formula 2 (presented in chapter 2.1). Logarithmic returns are multiplied by 100 and are not adjusted for cash dividends.

In order to make a normalized assessment of all the countries' INDEXes and compare them against each other, Table 1 provides descriptive statistics for INDEXes' returns, while INDEXes' level statistics are shown in Appendix 2 for reference.

Table 1. Descriptive statistics of INDEXes in first log-differences.

Indicators	$\Delta \ln$ DAX	$\Delta \ln$ CAC 40	$\Delta \ln$ FTSE 100	$\Delta \ln$ OBX	$\Delta \ln$ BEL20	$\Delta \ln$ FTSE MIB	$\Delta \ln$ OMXCPI	$\Delta \ln$ AEX
Mean	0.006	0.003	0.003	0.006	0.002	0.000	0,007	0.005
Standard Error	0.004	0.004	0.003	0.005	0.004	0.005	0,004	0.004
Median	0.008	0.007	0.008	0.012	0.011	0.006	0,011	0.010
Standard Deviation	0.055	0.051	0.043	0.066	0.049	0.066	0,049	0.048
Sample Variance	0.003	0.003	0.002	0.004	0.002	0.004	0,002	0.002
Kurtosis	1.679	1.131	1.010	3.517	4.587	1.410	2,903	2.106
Skewness	-0.621	-0.293	-0.366	-0.950	-0.932	-0.410	-0,830	-0.620
Range	0.368	0.372	0.271	0.498	0.427	0.461	0,372	0.340
Minimum	-0.213	-0.189	-0.136	-0.306	-0.241	-0.254	-0,203	-0.214
Maximum	0.155	0.183	0.135	0.192	0.186	0.207	0,169	0.127
ADF test	-7.733***	-6.665***	-7.277***	-5.468***	-4.440***	-4.512***	-4.589***	-6.313***

Note: In this and the following tables, one, two, or three asterisks indicate significance at a 10%, 5%, or 1% level, respectively.

According to Table 1, all stock markets' returns are positive on average, given the timeline. OMXCPI has the highest average return (0,007); the lowest average return is presented by FTSE MIB.

All the INDEXes expressed leveling around 0,004 for Standard error, with three exceptions: FTSE 100 (0,003), OBX (0,005), and FTSE MIB (0,005). That can be interpreted as the stock markets in Italy and Norway being less predictable (compared to the linear regression trend) than the rest of the stock markets in the analysis.

Stock market volatility (standard deviation) in Norway (0,066) and Italy (0,066) is higher compared to the rest of the peers. Both countries are very much linked to energy markets, with one being one of the largest oil and gas exporters and the other being the largest energy importer. That difference between major economic regions is also observed using variance. Germany and France have the lowest data spread for returns (0,0017 and 0,0019, respectively), while Norway expressed the largest spread.

In addition to having the highest volatility, the dataset proves that Norway and Belgium also had more return fluctuations (highest Kurtosis in the list, 3.517 and 4.587, respectively) than any of the countries in the analysis. It is yet to be proven that the stock market of the largest energy exporter in Europe has been affected by oil and gas peaks.

Norway’s OBX and Belgium’s BEL 20 are also characterized by the lowest negative Skewness (-0.950 and /0.932, respectively), which in terms of investment might represent high future returns for higher volatility.

Figure 8 displays the stock price INDEXes and energy prices of eight countries. Energy prices are shown at the logarithmic scale for visualization and analysis purposes, and comparing INDEXes with those; the assumption is only applicable to Figure 8. Observations indicate that energy prices and stock markets exhibit positive or negative correlations during negative economic events in all countries. The most prominent positive correlation between oil price and stock price INDEXes has been observed during the Global Financial Crisis (2008) and COVID-19 pandemic (2019-2020) across all countries, resulting in higher volatility in stock markets (Appendix 3). This finding suggests that negative economic events result in lower stock market returns and higher volatility. This also indicates increasing uncertainty in the economy, which affects several economic aspects, including stock markets. In most countries except Norway, there has been a negative correlation between GAS and stock markets since the Russian withholding of gas (august 2021). This can be attributed to the rise in income of Norwegian energy companies, which took the place of Russian gas suppliers.

A) DAX (Germany)

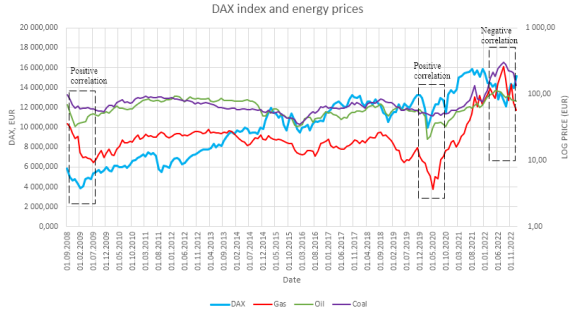

B) CAC 40 (France)

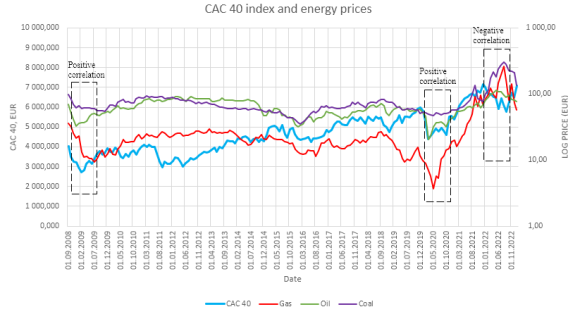

C) FTSE 100 (UK)

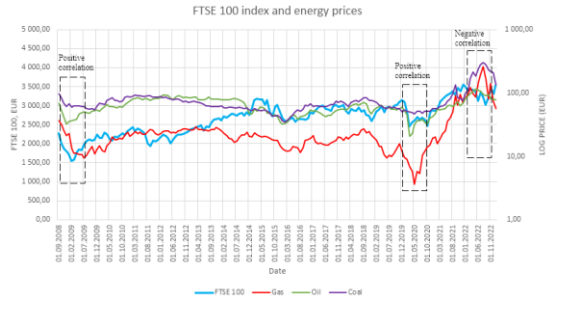

D) OBX (Norway)

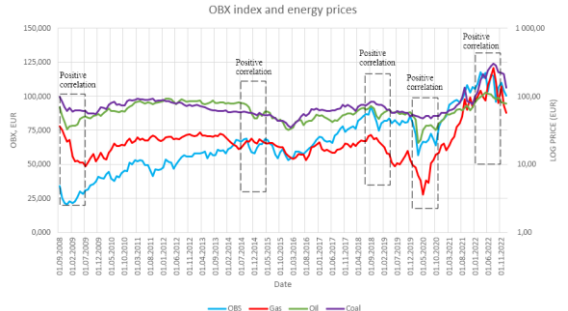

E) BEL 20 (Belgium)

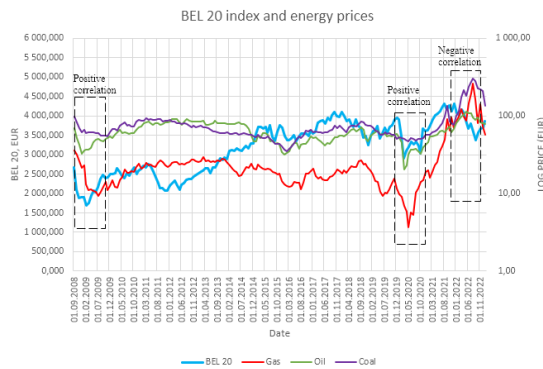

F) FTSE MIB (Italy)

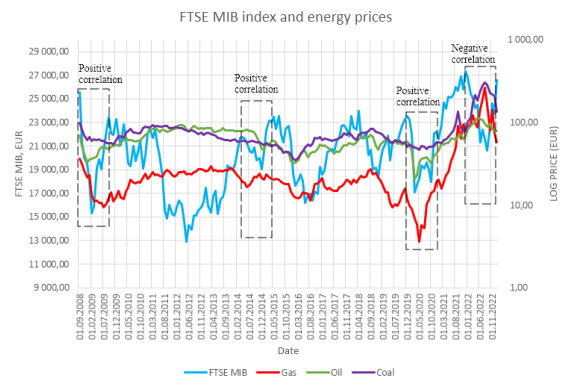

G) OMXCPI (Denmark)

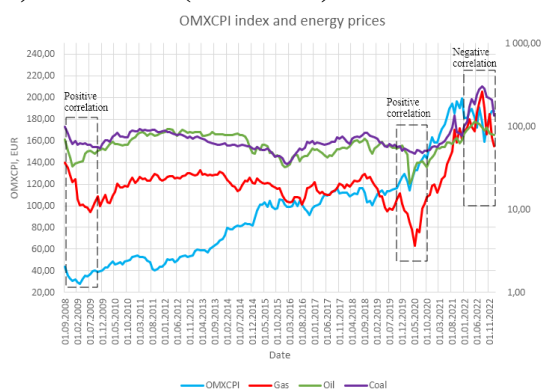

H) AEX (Netherlands)

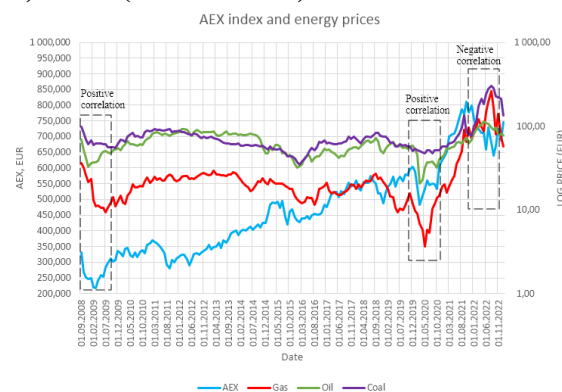

Figure 8. INDEXes and energy prices, EUR (fossil fuel prices in log levels).

4.1.2 Energy data

To investigate our research questions, we chose to analyze gas, oil, and coal future prices in Europe. For this purpose, the following indicators were collected:

- The natural gas TTF commodity future contracts (GAS) are for physical delivery through the transfer of rights in respect of natural gas at the TTF Virtual Trading Point, which is one of the largest gas trading hubs in Europe. It's Europe's largest natural gas benchmark, which trades in euros per megawatt hour. The GAS is influenced by various factors, including supply and demand dynamics, weather conditions, geopolitical events, and changes in the global energy market.
- Intercontinental Exchange (ICE) Europe Brent Crude Electronic Energy Future (OIL) is a type of futures contract that tracks the price of Brent crude oil in Europe. It is traded electronically on the ICE platform, which offers traders around the world a transparent and efficient marketplace for buying and selling energy commodities. The current Brent

blend consists of crude oil produced from the Forties, Oseberg, Ekofisk, and Troll Norwegian oil fields. This futures contract allows investors to speculate on the future price of Brent crude oil, which is one of the most widely traded oil benchmarks in the world. By trading OIL, investors can hedge their exposure to fluctuations in oil prices, which can have a significant impact on the global economy. Two-thirds of the world's crude oil supplies that are traded globally are priced using Brent. It serves as one of the two primary benchmark prices used to purchase oil globally, along with West Texas Intermediate.

- The API 2 futures coal price assessment (COAL) is the benchmark used to determine the price of coal in the European market. It is published by Argus Media, a leading provider of price assessments, market data, and news for the energy and commodities sectors. The COAL assessment is based on the physical delivery of coal cargoes with a calorific value of 6,000 kilocalories per kilogram (kcal/kg) from any of the following ports: Amsterdam, Rotterdam, or Antwerp (ARA). The price is quoted in US dollars per metric ton and is for delivery within the next calendar month. The assessment takes into account a range of factors that affect the price of coal, such as supply and demand dynamics, production costs, freight rates, and market sentiment. It is widely used by market participants, including buyers and sellers of coal, traders, and analysts, to price and settle contracts, as well as to monitor and manage risk in their portfolios.

The data for GAS, OIL, and COAL are transformed into stationary series by taking the first differences of natural logarithms; the formula is presented in Chapter 2.1 (Formula 2).

Similarly with INDEXes, descriptive statistics for energy prices are presented in first log-differences in Table 2, while statistics in level are shown in Appendix 4.

According to Table 2, the fossil fuel market has shown significant variability over the last 15 years. GAS has the highest mean (0,0047) over OIL and COAL, which also characterized the highest range of 1.3944. That is the result of the extraordinary price increase for gas since the pandemic, when it increased from 3.6 to 82 EUR per megawatt hour in just over 15 months (from May 2020 until January 2022), as shown in Figure 7. The Russian invasion of Ukraine had led to GAS reaching its peak of 350 EUR in August 2022, and since then the price had steadily been declining.

Table 2. Descriptive statistics of energy prices in first log-differences.

Indicators	GAS	OIL	COAL
Mean	0.0047	0.0002	0.0029
Standard Error	0.0144	0.0083	0.0071
Median	0.0010	0.0119	-0.0038
Standard Deviation	0.1895	0.1088	0.0928
Sample Variance	0.0359	0.0118	0.0086
Kurtosis	3.3235	16.7089	6.1680
Skewness	-0.1335	-2.4501	0.2136
Range	1.3944	1.1207	0.8734
Minimum	-0.7300	-0.7986	-0.4567
Maximum	0.6644	0.3221	0.4167
ADF test	-4.8608***	-5.7826***	-4.1888***

Note: See note for Table 1.

COAL is described by the 2nd largest mean (0,0029), which is still significantly higher than the OIL return (0,0002). Coal and gas have been traditionally major energy sources for heat production, which can also explain why both GAS and COAL peaks (historic highs) appeared in the pre-winter season in August 2022 (Figure 7). This is due to the market's realization of a potential supply shortage for winter 2023.

The minimum mean return (0,0002) amongst the fossil fuel market was demonstrated by OIL. With that fact in mind and comparing it with Kurtosis of 16,7, investment in oil had the biggest financial risk over the period of analysis. However, higher returns for GAS and COAL are driven by historic highs achieved in 2022, which was not the case for OIL.

The dynamics of fossil fuel returns are depicted in Figure 9, which reveals the significant level of volatility witnessed during notable economic and political events such as the Global Financial Crisis (2008), the COVID-19 pandemic (2019-2020), and the Russian withholding of gas supply (2021) and invasion of Ukraine (2022). GAS experienced considerable volatility during all three events, and it is worth noting that the third period of high volatility commenced in 2021 before the Russian invasion of Ukraine, contrary to popular belief. OIL displayed noteworthy volatility during the Global Financial Crisis and pandemic. COAL had a high volatility period during both the Global Financial Crisis and the Russian invasion of Ukraine, and the second period commenced in 2021, in line with GAS.

A) GAS return, %

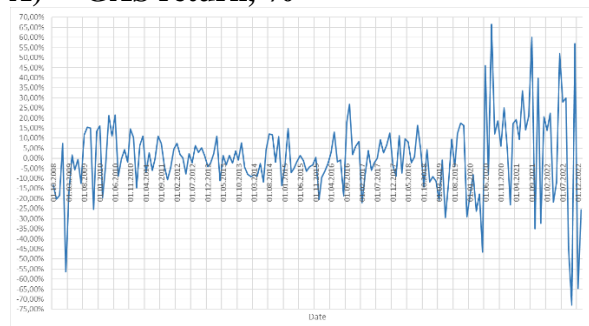

B) OIL return, %

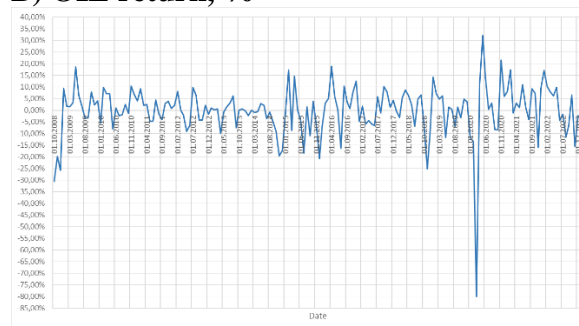

C) COAL return, %

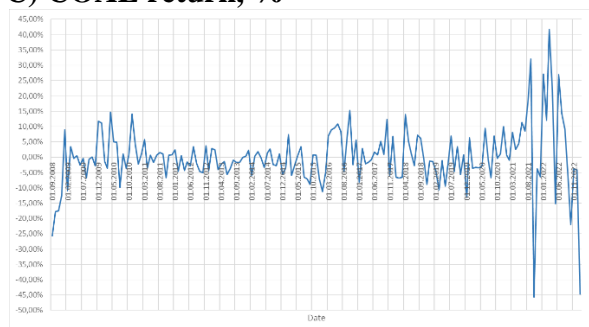

Figure 9. The dynamics of fuel fossil returns.

4.1.3 Industrial production and Interest rate data

We chose IPI as the first control variable for the analysis, which measures real output in the manufacturing, mining, electricity, and gas industries. IPI has a monthly basic. Since high levels of industrial production can result in unchecked levels of consumption and quick inflation, IPI is used as an indicator of activity on both the supply and demand sides as well as by central banks to calculate inflation.

The data was collected as a percentage year on year, seasonally adjusted, relative to a base year of 2010 = 100. It means that IPI expresses the percentage change in production relative to 2010.

Table 3 provides descriptive statistics about the IPI for the analyzed countries.

According to Table 3, the UK and Denmark had been leading the growth of IPI by 0,46 and 0,32%, respectively, on average, while major European economies such as Germany, France, Norway, and Italy had demonstrated a decrease in IPI.

Italy displays the greatest volatility, as evidenced by its range of 123%. Conversely, the Netherlands and Denmark showcase the most unwavering industrial production rates, with values standing at 12% and 29%, respectively.

The second control variable is the Interest rate (IR). The IR was measured using the Long-Term Government Bond Yields, 10-Year, Main (Including Benchmark), not seasonally adjusted. It is transformed into a stationary series by taking the first differences.

Table 3. Descriptive statistics of IPI.

Indicators	Germany	France	UK	Norway	Belgium	Italy	Denmark	Netherlands
Mean	-0.0003	-0.0066	0.0046	-0.0004	0.0016	-0.0080	0.0032	0.0000
Standard Error	0.0060	0.0053	0.0041	0.0021	0.0026	0.0080	0.0031	0.0015
Median	0.0050	0.0004	0.0063	0.0000	0.0000	-0.0028	0.0053	0.0010
Standard Deviation	0.0790	0.0700	0.0540	0.0273	0.0340	0.1049	0.0407	0.0202
Kurtosis	4.3167	13.6148	10.9660	1.6930	1.8832	21.6882	2.4866	0.5544
Skewness	-0.3024	0.2948	1.6850	0.2829	0.3135	1.9994	0.5317	-0.0916
Range	0.6635	0.7928	0.5113	0.1986	0.2466	1.2296	0.2881	0.1163
Minimum	-0.2993	-0.3504	-0.1714	-0.0832	-0.1171	-0.4413	-0.1198	-0.0626
Maximum	0.3641	0.4424	0.3399	0.1154	0.1295	0.7883	0.1683	0.0536
ADF test	-3.789**	-4.139***	-3.382*	-6.370***	-5.954***	-3.900**	-4.994***	-7.187***

Note: See note for Table 1.

In order to analyze descriptive statistics of IR, below we present statistics in level (Table 4); nevertheless, descriptive statistics of IR in first differences are shown in Appendix 5 for reference.

Table 4. Descriptive statistics of IR in level.

Indicators	Germany	France	UK	Norway	Belgium	Italy	Denmark	Netherlands
Mean	1.06	1.56	2.03	2.24	1.72	3.00	1.24	1.32
Standard Error	0.09	0.10	0.08	0.07	0.12	0.12	0.10	0.10
Median	0.68	1.07	1.82	1.96	1.04	2.76	0.94	0.86
Standard Deviation	1.24	1.31	1.10	0.96	1.51	1.57	1.27	1.34
Kurtosis	-0.92	-1.27	-0.90	-0.77	-1.26	-0.93	-0.72	-1.02
Skewness	0.52	0.31	0.37	0.50	0.41	0.31	0.61	0.44
Range	4.53	4.52	4.37	3.76	5.23	6.48	5.02	4.78
Minimum	-0.65	-0.34	0.21	0.47	-0.39	0.58	-0.59	-0.55
Maximum	3.88	4.18	4.58	4.23	4.84	7.06	4.43	4.23
ADF test	-3.05	-3.58**	-3.18*	-3.25*	-3.27*	-2.87	-2.81	-3.47**

Note: See note for Table 1.

Table 4 displays that Italy, Norway, and the UK have the highest average IR over the period, which equals 3%, 2.24%, and 2.03%, respectively. Italy has the highest observed maximum IR

(7.06) and highest level of volatility, with a Standard Deviation of 1.57. Norway and the UK have the lowest volatility, with Standard Deviation of 0.96 and 1.57, respectively.

4.2 Methodology

4.2.1 VAR approach

This study applies the multivariate VAR model. These models are used for multivariate time series, and they are an especially practical tool when it comes to investigating financial time series and forecasting. It enables an evaluation of the effects of shocks to variables on the forecast error variances of the respective and other model variables. Using rolling-window estimates, connectivity plots can show how the connectedness measure has changed over time.

Since the primary goal of the study is to assess the impact of energy prices on INDEXes, we focus on examining energy prices' returns and INDEXes' returns. Nevertheless, we include the control variables to capture some of the most significant transmission channels through which energy prices may influence stock prices indirectly, such as by causing changes in economic policy. Those channels include the impact of energy prices on interest rates, and industrial production, both of which induce changes in stock prices through the NPV of companies.

The VAR model includes the following endogenous variables: INDEX, GAS, OIL, COAL, IPI, and IR. We apply eight VAR models (separately for each country). The VAR model of order p (p -lags of y) can be defined as:

$$y_t = \alpha + \sum_{i=1}^p \Phi_i y_{t-i} + \varepsilon_t, \quad (3)$$

where y is a vector of endogenous variables, $\alpha = (\alpha_1, \dots, \alpha_n)$ is the intercept vector of the VAR model, Φ_i is the i th ($n \times n$) matrix of the autoregressive coefficients for $i = 1, 2, \dots, p$, and $\varepsilon_t = (\varepsilon_{1t}, \dots, \varepsilon_{nt})$ is the vector of white noise error terms.

We investigate the relationships between fossil fuel prices and INDEXes using several methods. First, joint hypothesis testing investigates multiple coefficient restrictions simultaneously by constructing a T-statistic. Second, the impulse response analysis and the Variance decomposition show the dynamic response of each variable to a one-time unit shock in each of the variables in the system. Third, the Granger causality test examines whether one variable can help predict another variable in the VAR model.

Before delving into the impact of energy shocks on stock markets, the study examines the stochastic characteristics of the model's series by conducting a series of unit root tests to determine their order of integration. The ADF test is specifically used, and the formal test results, presented in Tables 1-3 and Appendix 5, indicate that after being transformed into first differences or the natural logarithm of first differences, all series become stationary. Consequently, Equation 3 defines the vector y as comprising the first log differences of stock price INDEXes and fossil fuel prices, the first differences of the IR, and the IPI in levels as a percentage year on year.

All countries included in the study share a common sample period consisting of 172 monthly observations. In order to determine the appropriate length for lag, various tests such as the Akaike information criterion (AIC), Hannan-Quinn information criterion (HQ), and Schwartz (SC) are taken into consideration. A smaller value for any of these criteria indicates a better fit. If the results of the tests are contradictory, the suggested lag length is selected based on the AIC test.

The next step in analysis is testing the joint hypothesis. The null hypothesis is that all coefficients are equal to zero, indicating no relationships between the variables. If the T-statistic is large enough and the p-value is smaller than the predetermined significance level, the null hypothesis is rejected, indicating the presence of at least one significant coefficient in the VAR model.

To analyze the response of the system to an actual energy shock, we can convert the VAR system into its Moving Average representation using the following formula:

$$y_t = \mu + \sum_{i=0}^{\infty} M_i \varepsilon_{t-i} \quad , \quad (4)$$

where M_0 is the identity matrix, μ is the mean of the process, and ε_t is the error term. The moving average representation allows for the acquisition of both impulse response functions and decompositions of forecast error variance.

To evaluate how energy shocks affect stock markets, we analyze the accumulated response. This involves determining a hierarchy for the variables in the system. For our baseline model, we assume the following order: GAS, OIL, COAL, IPI, IR, and INDEX. A significant impulse response indicates that the variable has a significant impact on the other variables in the model.

Lastly, we explore the causal relationships between all variables in the system by applying the Granger causality concept, which tests how the past value of one variable can predict or cause the future value of another variable. This method helps us identify the direction and strength of causality across all the variables in the model and understand the underlying mechanisms driving our system.

4.2.2 DLM approach

In this section, we introduce the DLM approach for studying changes in variables over time and comparing two periods. The DLM is a statistical approach that describes time series as a combination of different components, including seasonality, and trends. The parameters and variance of the model can change over time, and the components of the model are linearly related. The equations in the model represent the relationships between an observed time series and the components of the model.

Our methodology includes four regressions' models:

1.
$$INDEX_t \sim GAS_t + COAL_t + OIL_t + IPI_t + IR_t + \varepsilon_t \quad (5)$$

2.
$$INDEX_t \sim L(INDEX, 1) + GAS_t + COAL_t + OIL_t + IPI_t + IR_t + \varepsilon_t \quad (6)$$

3.
$$INDEX_t \sim L(INDEX, 1) + GAS_t + L(GAS, 1) + COAL_t + L(COAL, 1) + OIL_t + L(OIL, 1) + IPI_t + L(IPI, 1) + IR_t + L(IR, 1) + \varepsilon_t \quad (7)$$

4.
$$INDEX_t \sim L(INDEX, 1) + GAS_t + L(GAS, 1:3) + COAL_t + L(COAL, 1:3) + OIL_t + L(OIL, 1:3) + IPI_t + L(IPI, 1:3) + IR_t + L(IR, 1) + \varepsilon_t, \quad (8)$$

where L() - lagged values of the variable, ε_t - error term at time t

Formula 5 presents the variation of the INDEXes based on contemporaneous values of explanatory variables. The study of partial autocorrelation revealed that INDEXes followed autoregressive processes of order one, while the other variables exhibit lag effects of one or multiple periods (Appendix 6). Formula 6 investigates the variation of the INDEXes from the value of the INDEXes itself in the previous period (lagged values) and the contemporaneous values of explanatory variables. Formula 7 looks at the variation of the INDEXes from the values of the INDEXes themselves and explanatory variables in the previous period, and the contemporaneous values of explanatory variables. Formula 8 explores the variation of the INDEXes from the value of the INDEXes itself in the previous month, the values of explanatory

variables in the analyzed period, and the values of explanatory variables in the previous 1-3 months.

To split the sample period into two subperiods we introduce dummy variables representing the economic and political conditions of two different time periods. The D1 is the pre-invasion period, which starts on February 23, 2021, and ends on February 23, 2022. The D2 is the post-invasion period, from February 24, 2022, to January 31, 2023.

Our analysis is based on iterative evaluations of different models and the selection of the best-fit model each time using the AIC criterion for model selection. The AIC helps us assess the goodness of fit and the trade-off between model complexity and explanatory power.

During the first iteration, we examine a long period and identify the most important explanatory variables. In the second iteration, we introduce dummy variables, D1 and D2, to account for the different time periods. This allows us to assess the effects of the subperiods and capture any unique dynamics that may be present. The third and fourth iterations focus on the pre-invasion and post-invasion periods, respectively. We refine the models by including the specific dummy variable for each period and its interactions with the other explanatory variables. This helps us gain a clearer understanding of the effects and dynamics specific to each timeframe, avoid potential multicollinearity issues, and reduce the complexity of the analysis.

By employing this iterative approach, we ensure a more robust analysis that considers the unique characteristics of each period. It enables us to identify the most influential variables and their associations with the INDEXes in a comprehensive manner.

We compare the significance and direction of long-run coefficients to those obtained during specific periods. Heteroscedasticity-robust estimation is used to address heteroscedastic residuals.

5. Empirical results

5.1 VAR framework and results

5.1.1 Joint Hypothesis Testing

In this section, we focus on the significance of the impact of GAS, OIL, COAL, IPI, and IR on INDEXes. Different tests are carried out for linear specifications in all countries.

To investigate the overall significance level of the proposed restrictions, we apply joint hypothesis testing. Table 5 shows the estimated coefficients of the VAR model with an order of 1 for the scenario where the dependent variable is INDEX.

Table 5. VAR model estimation results for the INDEXes (2008.09 - 2023.01).

ASSET	INDEX	GAS	OIL	COAL	IPI	IR
DAX (Adjusted R ² =0.023)	0.061 (0.084)	-0.067** (-2.509)	0.011 (0.242)	0.078 (1.368)	-0.036 (-0.653)	2.324 (0.882)
CAC 40 (Adjusted R ² =0.012)	0.047 (0.086)	-0.063** (-2.551)	0.015 (0.366)	0.082 (1.552)	0.029 (0.490)	-1.617 (-0.708)
FTSE 100 (Adjusted R ² =0.048)	0.060 (0.086)	-0.048** (-2.238)	0.016 (0.447)	0.064 (1.464)	0.031 (0.502)	1.425 (0.846)
OBX (Adjusted R ² =0.096)	0.158* (0.089)	-0.067** (-2.175)	-0.088 (-1.482)	0.177*** (2.692)	-0.142 (-0.782)	8.061** (2.497)
BEL20 (Adjusted R ² =0.047)	0.170** (0.084)	-0.045* (-1.853)	-0.025 (-0.616)	0.084 (1.650)	0.180 (1.574)	-3.044 (-1.424)
FTSE MIB (Adjusted R ² =0.120)	-0.025 (0.080)	-0.065** (-2.105)	0.034 (0.680)	0.120* (1.893)	0.036 (0.750)	-8.382*** (-4.809)
OMXCPI (Adjusted R ² =0.017)	0.168** (0.078)	-0.023 (-0.967)	-0.005 (-0.126)	0.082* (1.704)	-0.055 (-0.588)	-0.124 (-0.063)
AEX (Adjusted R ² =0.018)	0.115 (0.080)	-0.052** (-2.154)	-0.013 (-0.327)	0.110** (2.237)	0.035 (0.188)	-2.228 (-1.021)

Note: See note for Table 1. The numbers in parentheses represent T-statistic values.

The lagged changes in GAS have a significant negative impact on most European stock markets, as indicated by the statistical significance of the corresponding coefficient at the 5% level in all countries except for Belgium and Denmark. We observe 10% statistical significance in Belgium, while the stock market in Denmark does not react to lagged changes in GAS.

The Norwegian stock market reacts to the lagged COAL changes at a 1% statistical significance level. This effect on the stock market may be due to the fact that Norway is a coal exporter, with Germany, Spain, and the Netherlands being the main destinations of coal exports from Norway. In addition to a significant coal price increase (Future 5), production in Norway has grown by 23% in 2022 compared to the previous year. Earlier, Norway planned to stop coal production in 2023 but extended coal mining until 2025 in the Arctic Svalbard archipelago due to European demand for fossil fuels.

According to the investigated model, the Danish stock market is influenced by the lagged COAL movements at a 5% significant level. During the sample period, the Danish energy system was transformed from fossil fuel energy to renewable sources, especially wind energy.

In 2021, 80% of electricity production in Denmark came from renewable energy. Nevertheless, according to the Danish Energy Agency, during the highest historical coal prices, namely in 2022, Denmark imported significantly more coal compared to prior years.

The Italian stock market is influenced by IR at a 1% significant level, which might be caused by a high level of IR's volatility (Table 4); for instance, IR in Italy increased more than 4 times in 2022 relative to 2021.

It is interesting to note that the stock markets in the countries considered do not react to either OIL movements or IPI. Most of the previous studies have found evidence of the influence of OIL and IPI on stock markets just during price shocks. To separately investigate the influence of each variable on stock markets, the following sections exhibit the results of other analytical techniques.

5.1.2 Variance decomposition analysis and impulse response function

In this section, our analysis focuses on determining how each shock affects other variances of the forecast error. We utilize the forecast error variance decomposition of our model at the 6-months horizon to identify the proportion of unexpected changes in the variables that can be attributed to each shock. The results are presented in Table 6.

Table 6. Variance Decomposition at the 6 months horizon, %

Model	Innovation in	INDEX	GAS	OIL	COAL	IPI	IR
VAR (INDEX)	DAX	95.04%	2.12%	0.24%	1.51%	0.40%	0.69%
	CAC 40	95.76%	2.12%	0.40%	1.36%	0.06%	0.31%
	FTSE 100	95.91%	1.46%	0.41%	1.44%	0.05%	0.73%
	OBX	89.89%	0.73%	0.18%	5.04%	0.53%	3.63%
	BEL 20	95.19%	0.78%	0.07%	1.25%	1.59%	1.13%
	FTSE MIB	84.94%	1.61%	0.80%	1.16%	0.28%	11.21%
	OMXCPI	97.93%	0.04%	0.03%	1.80%	0.17%	0.03%
	AEX	96.06%	0.81%	0.02%	2.48%	0.06%	0.57%
VAR (GAS)	DAX	5.37%	89.23%	3.08%	0.21%	1.07%	1.03%
	CAC 40	5.18%	89.04%	2.97%	0.15%	1.61%	1.06%
	FTSE 100	4.42%	89.35%	3.19%	0.10%	1.30%	1.63%
	OBX	4.41%	89.24%	2.39%	0.34%	2.76%	0.85%
	BEL 20	4.30%	91.61%	2.59%	0.17%	0.99%	0.34%
	FTSE MIB	3.42%	89.45%	3.45%	0.13%	2.74%	0.82%
	OMXCPI	3.39%	91.43%	4.07%	0.14%	0.22%	0.74%
	AEX	4.97%	89.15%	4.34%	0.28%	0.41%	0.85%
VAR (OIL)	DAX	15.79%	0.45%	76.28%	4.09%	0.27%	3.11%
	CAC 40	21.14%	0.33%	72.04%	4.33%	0.11%	2.05%

Model	Innovation in	INDEX	GAS	OIL	COAL	IPI	IR
	FTSE 100	21.67%	0.38%	68.13%	4.03%	0.52%	5.26%
	OBX	34.01%	0.75%	53.48%	2.88%	1.01%	7.87%
	BEL 20	22.76%	0.02%	70.52%	3.84%	1.14%	1.74%
	FTSE MIB	17.98%	0.09%	77.73%	4.05%	0.10%	0.06%
	OMXCPI	11.47%	0.10%	82.97%	3.76%	0.68%	1.01%
	AEX	19.13%	0.19%	74.12%	4.31%	0.36%	1.88%
VAR (COAL)	DAX	3.21%	27.88%	5.66%	62.69%	0.14%	0.42%
	CAC 40	4.06%	28.08%	5.82%	61.48%	0.14%	0.42%
	FTSE 100	3.29%	27.10%	4.56%	64.52%	0.01%	0.53%
	OBX	6.55%	24.32%	2.52%	63.17%	2.61%	0.83%
	BEL 20	3.10%	26.50%	3.55%	64.17%	1.46%	1.21%
	FTSE MIB	1.90%	26.03%	7.15%	63.74%	0.78%	0.39%
	OMXCPI	2.73%	25.99%	5.22%	65.61%	0.17%	0.29%
	AEX	2.68%	26.67%	4.69%	62.75%	1.97%	1.24%
VAR (IPI)	DAX	14.94%	0.05%	8.00%	1.27%	75.15%	0.59%
	CAC 40	13.04%	0.33%	7.63%	0.77%	78.19%	0.04%
	FTSE 100	11.24%	0.16%	5.11%	0.28%	80.32%	2.89%
	OBX	0.45%	5.74%	0.63%	0.92%	91.82%	0.44%
	BEL 20	4.25%	0.95%	3.71%	0.12%	90.83%	0.14%
	FTSE MIB	6.53%	0.07%	6.62%	0.56%	86.20%	0.01%
	OMXCPI	0.65%	4.42%	5.64%	1.86%	86.17%	1.27%
	AEX	8.10%	1.73%	1.65%	0.73%	87.36%	0.42%
VAR (IR)	DAX	1.94%	1.65%	0.19%	6.74%	0.35%	89.13%
	CAC 40	1.73%	2.12%	0.12%	5.55%	0.15%	90.32%
	FTSE 100	5.10%	7.65%	0.47%	2.79%	0.14%	83.85%
	OBX	5.33%	1.75%	3.68%	1.17%	0.77%	87.29%
	BEL 20	1.74%	2.13%	0.35%	5.72%	1.12%	88.94%
	FTSE MIB	0.50%	1.91%	0.28%	4.15%	1.15%	92.01%
	OMXCPI	4.32%	0.63%	0.52%	6.82%	0.22%	87.50%
	AEX	1.73%	0.82%	0.27%	5.49%	0.72%	90.97%

From Table 6, the variance decompositions for the INDEXes show that at the 6-months horizon, shocks to the INDEX itself account for 95.04%, 95.76%, 95.91%, 89.89%, 95.19%, 84.94%, 97.93%, and 96.06% of the variation in the DAX, CAC 40, FTSE 100, OBX, BEL 20, FTSE MIB, OMXCPI, and AEX, respectively. This means that the majority of the forecast error variance is explained by own shocks. This result is consistent with previous studies (Ghorbel & Jeribi, 2021; Lee, 1992; Sadorsky, 1999), which show that stock returns are primarily explained by innovations in stock returns. The most influential innovation in INDEXes by other variables is observed in Norway and Italy. In the Norwegian INDEX, COAL accounts for 5.04% of the variance decomposition, and IR accounts for 3.63%. The most influential variable in the Italian INDEX is IR, which accounts for 11.21%.

For GAS, almost all of the variance decomposition comes from the movements themselves (around 90% in all countries). This suggests that GAS movements can influence other economic variables, but changes in economic variables have little impact on GAS. This result reflects the fact that there is a high degree of monopoly in the European gas market when market mechanisms have a weak influence and a low level of competition is observed. The most influential variable on GAS variance decomposition is INDEX, which is consistent with the findings of Acaravci et al. (2012), who found a long-run relationship between stock returns and natural gas inflation in Austria, Denmark, Finland, Germany, and Luxembourg.

The variance decomposition of OIL depends on its movements being lower in grade compared with GAS. The lowest level is 53.48% in Norway, and the highest level is 82.97% in Denmark. During the sample period, the INDEXes explained a large portion of the forecast error variance for OIL in all countries taken into consideration.

The crucial element for the variance decomposition of COAL is GAS, which has a mean of 26.57% in the considered countries. This is due to the fact that the prices of GAS and COAL are highly correlated (Figure 7). Both gas and coal are inputs for industries since they provide energy for production. In most cases, coal might replace gas as a source of energy. However, this is undesirable due to the high pollution level caused by coal burning.

The variance decomposition of IPI depends more on OIL compared to GAS and COAL. This means that in the analyzed countries, many goods are still produced from petroleum and petrochemical products, such as plastic. The variance decomposition of IR largely depends on its past values; however, all variables in the model have an influence to a greater or lesser extent.

In order to assess the impact of energy shocks on endogenous variables, generalized impulse response functions are examined. An impulse response graph shows how a system responds to an impulse or a brief input signal. The graph represents the output of a system in response to a single impulse input. In the case of the impulse response function, we focus on the fossil fuel shocks on INDEXes, nevertheless, the results of IPI and IP shocks on stock market INDEXes are presented in Appendices 7 and 8.

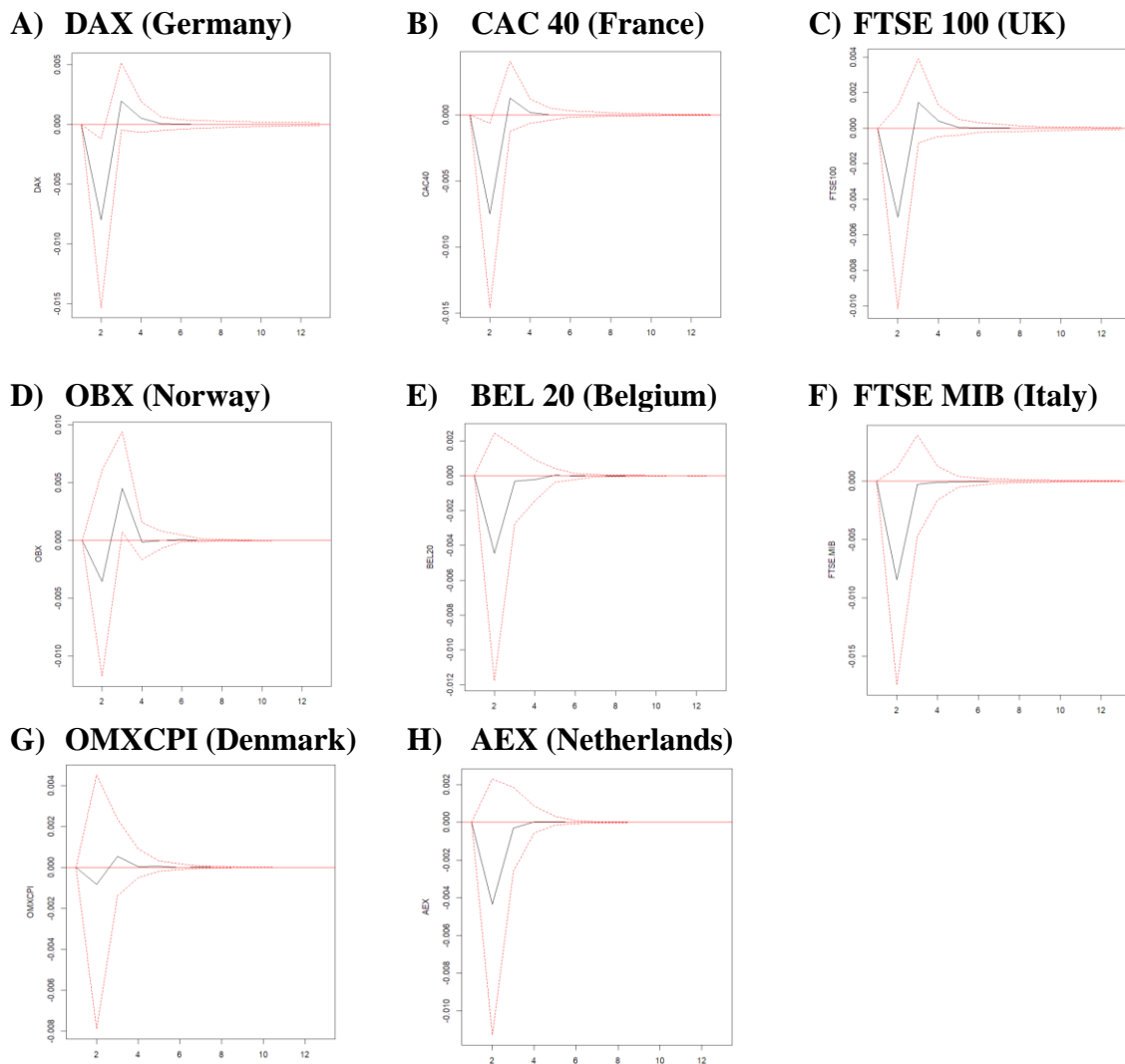

Figure 10. Impulse response function of GAS growth to INDEXes.

On Figure 10, the black lines indicate the response of the INDEXes to the GAS shocks, and the dashed red lines represent the 95% confidence bands for the response. The y-axis is the amplitude of the system's response. The x-axis represents the 12-month horizon and shows the duration of the impulse response waveform.

According to the graphs, the largest negative short-run influence takes place within the first three months in all considered countries, with peak values reached in the second month. Taking into account the confidence level, we confirm significant results in Germany, France, and Norway (in the third month).

We observed the asymmetric response in Germany, and France. A short-run shock to GAS initially decreases INDEXes. This negative response sharply declines in the 2nd month from where it remains in the negative region to about the period between the 2nd and 3rd months,

however, with increasing tendencies. From this period on, the response rises above its steady-state value to about the 3rd month. Then the response gradually declines but remains in the positive region. In the period between the 5th and 6th months, it hits its steady-state value. The negative response outweighs the positive one. These countries are highly dependent on gas supplies, which is the reason for this.

In Norway, the subsequent positive effect in the third month exceeds the initial negative reaction in the first two months, when the level of uncertainty was high. Because Norway is the largest gas producer and exporter in Europe, covering 20-25% of the gas consumption, it is expected that higher gas prices would lead to more favorable financial market conditions.

The minimal influence of GAS shocks on the Danish INDEX compared to the rest of the countries confirms the previous results of Sections 5.1.1, which indicate that GAS is not a significant variable for INDEX movements. Denmark had been a net exporter of GAS until 2018. Currently, the country has minimized gas consumption and replaced it with renewable energy.

Figure 11 represents impulse response function of OIL growth to INDEXes.

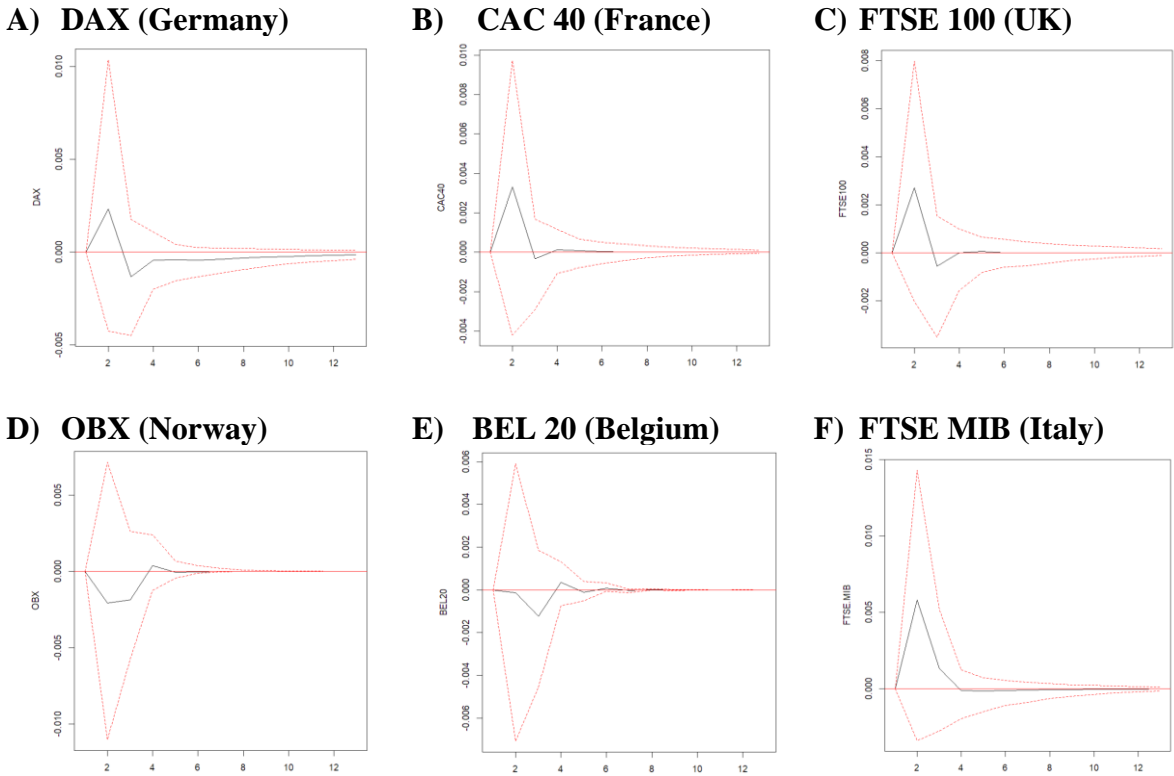

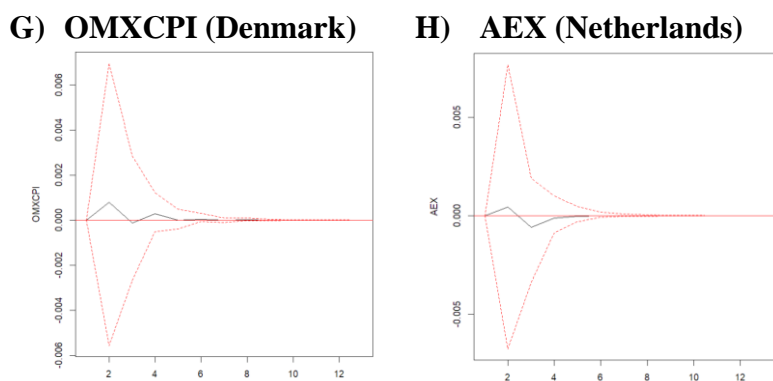

Figure 11. Impulse response function of OIL growth to INDEXes.

According to Figure 11, OIL growth had an asymmetric impact on INDEXes in most of the considered countries (except Italy) during the sample period. The largest influence of the shock takes place within the first three months; at the same time, we observe a high level of uncertainty (the dashed red lines have a significant spread), which decreases in 3rd month.

The short-run negative impact is noticed in Norway, which stabilizes in the 4th month, but the level of uncertainty is high. Theoretically speaking, Norwegian INDEX should be positively correlated with OIL movements. We cannot observe any similarity between this result and earlier studies by Gjerde & Sættem (1999) and Bjørnland, (2009), who present evidence of a direct positive impact of OIL on stock prices in Norway. Nevertheless, we are analyzing a full sample period that has been highly influenced by global events, as pointed out earlier, so the results may not be comparable.

We note the little positive effect in Germany, France, the UK, and Italy for three months, which stabilizes after the 4th month, where it hits its steady state value. In particular, the OIL shock exerts a positive but statistically insignificant impact on INDEXes. The reason for the positive relationships may be due to the demand factor in these countries, which is also mentioned in Kilian's (2009) study. This finding supports the study of Park & Ratti (2008), who found little evidence of asymmetric effects for the oil-importing European countries.

The movements of the INDEXes in Belgium, Denmark, and the Netherlands are minimal. In addition to the high level of uncertainty, these responses suggest that OIL shocks do not affect INDEXes. This finding is in line with Huang et al. (1996), who failed to detect any relationship between energy prices and stock prices, and Jiang & Yoon (2020), who proved that the stock prices of an oil-importing country are only linked to the oil price during a financial crisis.

In addition, it's important to note that the results can significantly vary depending on the crisis due to demand and supply factors. Therefore, there is no consensus about the direction of the relationships between stock prices and oil prices across studies. Some authors, such as Antonakakis et al. (2017), Apergis & Miller (2009), and Kilian & Park (2009), have found different effects due to oil supply and demand shocks. These authors have also discovered that global demand exerts a positive impact on real stock returns, while idiosyncratic oil price demand has a negative impact on stock returns. However, our results cannot be compared since we analyzed the full sample period.

Figure 12 represents the impulse response function of COAL growth to INDEXes.

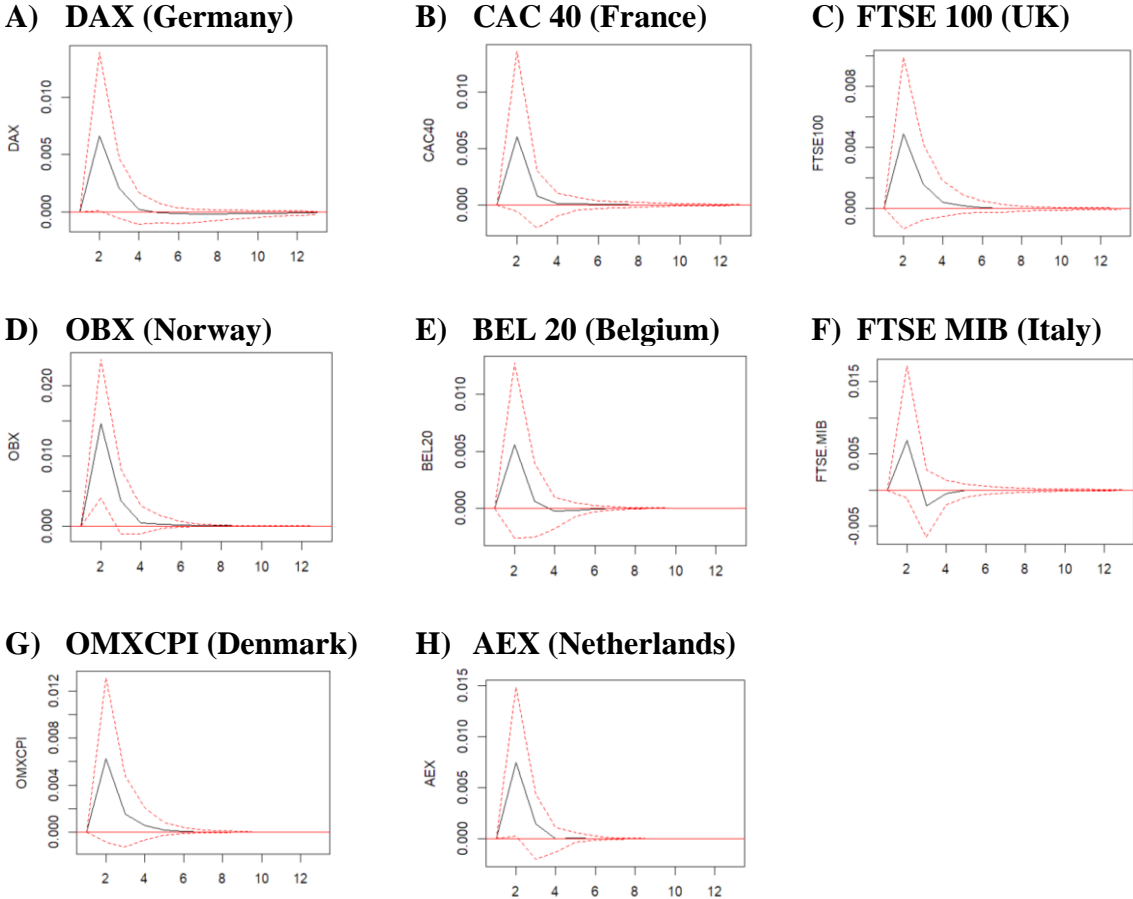

Figure 12. Impulse response function of COAL growth to INDEXes.

The observed positive impact of COAL growth across countries with significant results, namely Norway, Germany, the Netherlands, may indicate that there were no issues with the supply and demand of COAL during the sample period. All changes in COAL and INDEX prices were driven by common factors such as the Global Financial Crisis and the COVID-19 pandemic, whereby all economic indicators fell and rose simultaneously.

The highest peak of the INDEX response and the highest level of reliability of the results are observed in Norway, confirming the findings of Sections 5.1.1 regarding the significant influence of COAL on the INDEX in the Norwegian model.

5.1.3 Granger-causality analysis

In this section, we examine the relationships of Granger causality between all variables in the model for each country analyzed. The outcomes of the Granger causality tests can be found in Appendix 9.

Our approach consists of various stages. Firstly, we determine if a specific GAS variable has a Granger influence on the other variables in the model. We discovered that GAS variables generally hold Granger influence on the other variables at a 10%, 5%, or 1% level of significance (Appendix 9, lines 1–3 for each INDEX). Secondly, we examine whether an OIL variable has Granger-causality relationships with the INDEXes, IPI, and IR. We observe that OIL variables have Granger influence on some variables (lines 4–6 for each INDEX). Thirdly, we test whether COAL variables Granger-cause the remaining variables in the model and found that COAL variables Granger-cause INDEXes and IR (lines 7–9 for each INDEX). Fourthly, we execute a test to determine if there is a lack of relationships between the INDEXes and the remaining variables in the model (lines 10–14 for each INDEX). We note that INDEXes influenced GAS, COAL, and OIL. Finally, we test the null hypothesis that the INDEXes are Granger-caused by the other variables in the model, and generally, we reject the null hypothesis (lines 15–16 for each INDEX).

We have plotted the Granger causality relationships (Figure 13) based on the results (Appendix 9) to clarify all existing relationships. On the plots below, each of the arrows represents Granger causality relationships, where the direction of the arrows points out from the independent variable towards the dependent variable.

A) DAX (Germany)

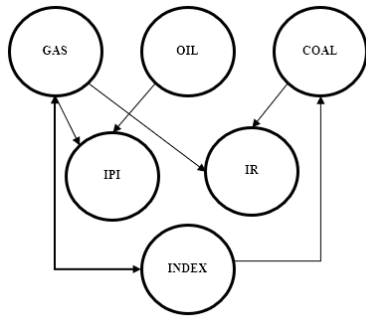

B) CAC 40 (France)

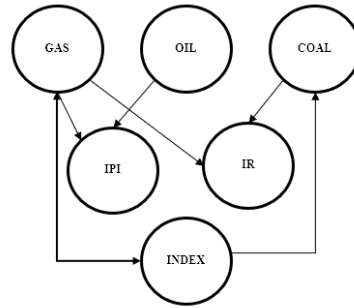

C) FTSE 100 (UK)

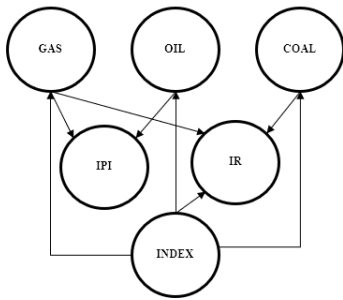

D) OBX (Norway)

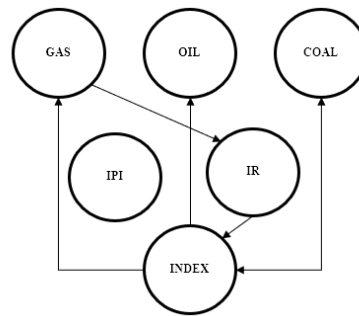

E) BEL 20 (Belgium)

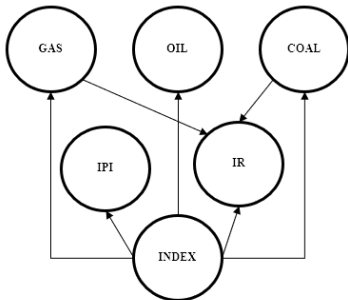

F) FTSE MIB (Italy)

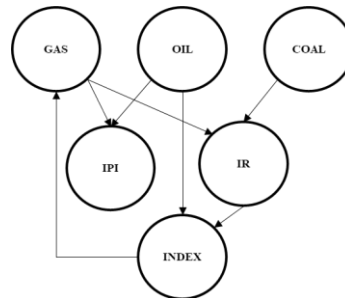

G) OMXCPI (Denmark)

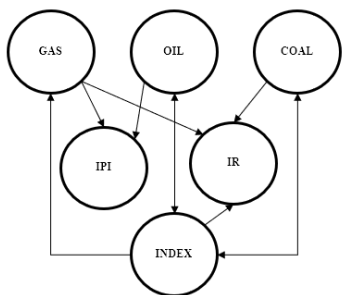

H) AEX (Netherlands)

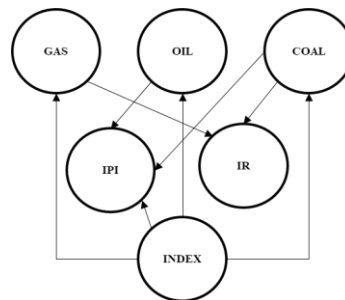

Figure 13. Granger causality relationship flows.

The main findings can be summarized as follows:

- There is a unidirectional Granger causal relationship from INDEXes to GAS in the UK, Norway, Belgium, Italy, Denmark, and the Netherlands, and a bilateral relationship between INDEXes and GAS in Germany and France.
- There is a unidirectional Granger causal relationship from INDEXes to OIL in the UK, Norway, Belgium, Denmark, and the Netherlands, and from OIL to INDEX in Italy.
- There is a unidirectional Granger causal relationship from INDEXes to COAL in Germany, France, the UK, Belgium, and the Netherlands and a bilateral relationship between COAL and INDEX in Norway and Denmark.
- There is an indirect relationship from GAS to INDEXes in Norway, and Italy through IR. GAS primarily affects IR in Norway and Italy, and then IR affects the INDEXes (monetary channel).
- There is an indirect relationship from INDEXes to OIL in the UK, Norway, Belgium, Denmark, and the Netherlands, and from OIL to INDEX in Italy.
- There is a bilateral relationship between OIL and INDEX in Denmark.
- GAS and OIL affect IPI in Germany, France, the UK, Italy, and Denmark; in addition, OIL impacts IPI in the Netherlands.
- GAS movements influence IR across all countries.

The findings indicate that the relationship between fossil fuels, especially GAS, and other variables is largely meaningful, as there is a noticeable impact going in at least one direction within all countries and occurring in both directions in most countries.

The study conducted by Acaravci et al. (2012) suggests that there is a Granger causal relationship between natural gas prices, industrial production, and stock prices. The study includes one indirect channel (the output channel), which may potentially influence the stock market (ignoring the monetary channel). Then the regression model includes one control variable, namely industrial production. The result appears to be that a raise in natural gas prices has a significant impact on the growth of industrial production initially in Finland and Germany. However, in the remaining ten EU-15 nations, no such connection is detected among these factors. Except for Denmark, Acaravci et al. (2012) did not detect any direct Granger causal relationship between the rise in natural gas prices and stock returns in these countries during the sample period from the first quarter of 1990 to the first quarter of 2008.

In their research, Hatemi-J et al. (2017) analyzed the Granger causality relationship between oil prices and stock prices for both the global market and the G7 countries during the time span from January 1975 to October 2013. Their findings align with our observations (except Italy), in that the utilization of standard symmetric causality concludes that there is no causal influence stemming from oil prices on either the global market or any of the individual G7 countries' stock prices.

To summarize, we have proved direct Granger causal relationships from INDEXes to GAS across all countries; direct Granger causal relationships from GAS to INDEXes in Germany and France; and indirect Granger causal relationships from GAS to INDEXes in Norway and Italy.

5.2 DLM framework and results

This section investigates the relationships between INDEXes and other variables during different periods using the basic regression models represented by Formulas 5-8. Each model, whether basic or transformed, was assessed for all indexes and periods, and the most suitable model was chosen based on the AIC criteria. A concise overview of the outcomes of the best models, determined through AIC, is provided in this section, categorized by INDEX. Additionally, a comprehensive presentation grouped under sections labeled "Regression 1", "Regression 2", "Regression 3" and "Regression 4" is presented in Appendix 10.

Regression 1 represents the best results obtained when evaluating the basic models without any transformations. Conversely, Regression 2 presents the best results achieved after including the dummies D1 and D2 into the models. Notably, the inclusion of these dummy variables led to a reduction in the overall explanatory power compared to Regression 1. Regressions 3 and 4 pertain to models that incorporate either the D1 or D2 dummy variables, along with their respective interactions with other explanatory variables. The explanatory power of these regressions varies across different indexes, indicating the varying effectiveness of our variables in describing the performance of the INDEXes in each analyzed period.

Table 7. Summary of dynamic regressions performed for the DAX (2008.09 - 2023.01)

(1)		(2)		(3)		(4)	
N/A	N/A	L(Index,1)	0.030 (0.083)	N/A	N/A	N/A	N/A
GAS	0.035 (0.026)	GAS	0.036 (0.027)	GAS	0.036 (0.027)	GAS	0.024 (0.034)
COAL	-0.154*** (0.057)	COAL	-0.166*** (0.058)	COAL	-0.143** (0.058)	COAL	-0.067 (0.084)

(1)		(2)		(3)		(4)	
OIL	0.225*** (0.048)	OIL	0.197*** (0.050)	OIL	0.229*** (0.049)	OIL	0.208*** (0.051)
IPI	-0.024 (0.153)	IPI	-0.019 (0.164)	IPI	0.031 (0.161)	IPI	-0.045 (0.158)
IR	-0.013 (0.009)	IR	-0.013 (0.009)	IR	-0.026** (0.012)	IR	-0.008 (0.010)
N/A	N/A	D1	0.009 (0.020)	D1	0.039 (0.040)	N/A	N/A
N/A	N/A	D2	0.0001 (0.016)	N/A	N/A	D2	0.022 (0.023)
N/A	N/A	N/A	N/A	D1*GAS	0.019 (0.273)	D2*GAS	0.023 (0.060)
N/A	N/A	N/A	N/A	D1COAL	-0.188 (0.713)	D2*COAL	-0.170 (0.131)
N/A	N/A	N/A	N/A	D1*OIL	-0.256 (0.508)	D2*OIL	0.211 (0.323)
N/A	N/A	N/A	N/A	D1*IPI	1.294 (2.370)	D2*IPI	-0.215 (1.362)
N/A	N/A	N/A	N/A	D1*IR	0.029 (0.022)	D2*IR	-0.083 (0.067)
Constant	0.006 (0.004)	Constant	0.007 (0.004)	Constant	0.005 (0.004)	Constant	0.006 (0.004)
Obs.	169	Obs.	169	Obs.	169	Obs.	169
Adj. R²	0.1109	Adj. R²	0.0754	Adj. R²	0.1097	Adj. R²	0.1087

Notes: One/two/three asterisks indicate rejection of the null hypothesis of no correlation at the 10%, 5%, and 1% significance levels, respectively. The null hypothesis assumes no significant relationship between the explanatory variable and INDEXes. Robust hypothesis tests were conducted to obtain p-values. The coefficients represent the estimated effects of the explanatory variables on the dependent variable. The numbers in parentheses indicate the standard errors of the coefficient estimates, reflecting the uncertainty associated with the estimates.

L(Index,1) represents the lagged value of the INDEXes. It captures the previous period's performance of the INDEX, allowing for an analysis of how past returns influence the current return.

D1*Explanatory variable represents the interaction of D1 with the specified explanatory variable. It allows for an analysis of how the relationship between the explanatory variable and the dependent variable differs during the period covered by D1. D2*Explanatory variable represents the interaction of D2 with the specified explanatory variable. It enables an analysis of how the relationship between the explanatory variable and the dependent variable differs during the period covered by D2.

The results listed in Table 7 for Germany correspond to regressions performed using Formula 5 (Model 1 of Section 4.2.2.):

$$INDEX_t \sim GAS_t + COAL_t + OIL_t + IPI_t + IR_t + \varepsilon_t$$

and Formula 6 (Model 2 of Section 4.2.2.):

$$INDEX_t \sim L(INDEX, 1) + GAS_t + COAL_t + OIL_t + IPI_t + IR_t + \varepsilon_t$$

The significant variables that explain the DAX are COAL and OIL, with both variables demonstrating the highest significance in Regressions 1 and 2. In Regression 3, while OIL

maintained its significance, COAL shared 5% of its significance with IR. Both COAL and IR exhibited negative relationships with the DAX, suggesting that an increase in COAL or higher interest rates were associated with negative impact on the DAX. In Regression 4, the only consistent explanatory variable was OIL, which maintained a significant level of 1% across all regressions and demonstrated a positive relationship with the DAX.

Table 8. Summary of dynamic regressions performed for the CAC 40 (2008.09 - 2023.01)

(1)		(2)		(3)		(4)	
GAS	0.041* (0.024)	GAS	0.042* (0.025)	GAS	0.046* (0.026)	GAS	0.034 (0.031)
OIL	0.227*** (0.046)	OIL	0.228*** (0.047)	OIL	0.229*** (0.048)	OIL	0.230*** (0.050)
COAL	-0.139** (0.058)	COAL	-0.144** (0.061)	COAL	-0.128** (0.060)	COAL	-0.122 (0.077)
IPI	-0.136 (0.221)	IPI	-0.135 (0.226)	IPI	-0.184 (0.233)	IPI	-0.075 (0.228)
IR	-0.019* (0.011)	IR	-0.020* (0.012)	IR	-0.021* (0.012)	IR	-0.017 (0.012)
N/A	N/A	D1	0.001 (0.020)	D1	0.031 (0.062)	N/A	N/A
N/A	N/A	D2	0.004 (0.016)	N/A	N/A	D2	0.017 (0.020)
N/A	N/A	N/A	N/A	D1*GAS	-0.070 (0.351)	D2*GAS	0.028 (0.056)
N/A	N/A	N/A	N/A	D1*OIL	-0.054 (0.558)	D2*OIL	-0.256 (0.256)
N/A	N/A	N/A	N/A	D1*COAL	-0.187 (1.040)	D2*COAL	-0.024 (0.129)
N/A	N/A	N/A	N/A	D1*IPI	0.992 (1.180)	D2*IPI	-2.768** (1.317)
N/A	N/A	N/A	N/A	D1*IR	-0.017 (0.115)	D2*IR	-0.068 (0.057)
Constant	0.004 (0.004)	Constant	0.003 (0.004)	Constant	0.004 (0.004)	Constant	0.003 (0.004)
Obs.	168	Obs.	168	Obs.	168	Obs.	168
Adj. R²	0.1317	Adj. R²	0.1204	Adj. R²	0.1125	Adj. R²	0.1285

Notes: See note for Table 7.

The results presented in Table 8 provide insights from the regression analysis conducted using Formula 5 (Model 1 of Section 4.2.2.) as a basic model:

$$INDEX_t \sim GAS_t + COAL_t + OIL_t + IPI_t + IR_t + \varepsilon_t$$

The findings indicate that several variables significantly influenced the CAC 40 index. OIL consistently demonstrated the highest level of significance in all Regressions, indicating a positive relationship with the INDEX. Additionally, COAL, GAS and IR were also found to be significant in Regressions 1, 2, and 3, with significant levels of 5% and 10%, respectively. GAS

and IR showed relatively lower levels of significance among the variables. Higher GAS and OIL prices were associated with favorable impacts on the INDEX, while higher COAL prices and increased IR were linked to lower stock returns. In Regression 4, only OIL maintained its significance, while the interaction between D2 and IPI became highly significant with a 5% level of significance. The negative coefficients of this interaction term suggest that increases in IPI during that period were associated with lower stock returns.

Table 9. Summary of dynamic regressions performed for the FTSE 100 (2008.09 - 2023.01)

(1)		(2)		(3)		(4)	
GAS	0.035* (0.019)	GAS	0.034* (0.019)	GAS	0.039** (0.020)	GAS	0.024 (0.023)
OIL	0.198*** (0.034)	OIL	0.197*** (0.035)	OIL	0.199*** (0.036)	OIL	0.196*** (0.036)
COAL	-0.099*** (0.038)	COAL	-0.101*** (0.038)	COAL	-0.094** (0.043)	COAL	-0.065 (0.049)
IPI	-0.021 (0.134)	IPI	-0.015 (0.135)	IPI	-0.039 (0.136)	IPI	-0.030 (0.134)
IR	-0.014 (0.016)	IR	-0.017 (0.016)	IR	-0.018 (0.018)	IR	-0.010 (0.016)
N/A	N/A	D1	0.009 (0.012)	D1	0.033* (0.022)	N/A	N/A
N/A	N/A	D2	0.005 (0.012)	N/A	N/A	D2	0.027 (0.016)
N/A	N/A	N/A	N/A	D1*GAS	-0.168* (0.144)	D2*GAS	0.039 (0.048)
N/A	N/A	N/A	N/A	D1*OIL	-0.285* (0.172)	D2*OIL	-0.039 (0.176)
N/A	N/A	N/A	N/A	D1*COAL	0.206 (0.202)	D2*COAL	-0.075 (0.081)
N/A	N/A	N/A	N/A	D1*IPI	-0.360 (0.647)	D2*IPI	4.481* (2.647)
N/A	N/A	N/A	N/A	D1*IR	0.050 (0.053)	D2*IR	-0.083 (0.080)
Constant	0.003 (0.003)	Constant	0.001 (0.003)	Constant	0.002 (0.003)	Constant	0.003 (0.003)
Obs.	169	Obs.	169	Obs.	169	Obs.	169
Adj. R²	0.1548	Adj. R²	0.1474	Adj. R²	0.1481	Adj. R²	0.1548

Notes: See note for Table 7.

The results listed in Table 9 correspond to regressions using the basic model explained by Formula 5 (Model 1 of Section 4.2.2.):

$$INDEX_t \sim GAS_t + COAL_t + OIL_t + IPI_t + IR_t + \varepsilon_t$$

In Regressions 1 and 2, the variables GAS, COAL, and OIL were found to be statistically significant. GAS and OIL demonstrated a positive relationship with the FTSE 100, suggesting that higher GAS and OIL were associated with higher stock returns. Conversely, COAL showed a negative relationship, indicating that higher COAL was linked to lower stock returns in the

FTSE 100. In Regression 4, only OIL remained significant for the FTSE 100, indicating that changes in OIL continued to have a significant and positive link with the performance of the INDEX. Additionally, the dummy variable D2 exhibited a positive relationship with the FTSE 100, suggesting that the specific political and economic conditions captured by D2 were associated with improved performance in the FTSE 100.

Table 10. Summary of dynamic regressions performed for the OBX (2008.09 - 2023.01).

(1)	(2)	(3)	(4)
L(Index,1) -0.141** (0.064)	L(Index,1) -0.146** (0.064)	L(Index,1) -0.151** (0.065)	L(Index,1) -0.142** (0.065)
GAS 0.059** (0.024)	GAS 0.060** (0.024)	GAS 0.061** (0.025)	GAS 0.041 (0.029)
OIL 0.403*** (0.046)	OIL 0.405*** (0.047)	OIL 0.421*** (0.048)	OIL 0.393*** (0.048)
COAL -0.066 (0.049)	COAL -0.062 (0.050)	COAL -0.043 (0.056)	COAL -0.054 (0.062)
IPI 0.021 (0.140)	IPI 0.017 (0.141)	IPI 0.017 (0.142)	IPI -0.078 (0.141)
IR -0.007 (0.037)	IR -0.001 (0.038)	IR -0.009 (0.039)	IR 0.014 (0.038)
N/A	D1 -0.010 (0.015)	D1 0.014 (0.020)	N/A
N/A	D2 -0.008 (0.015)	N/A	D2 0.018 (0.017)
N/A	N/A	D1*GAS -0.082 (0.106)	D2*GAS 0.071 (0.053)
N/A	N/A	D1*OIL -0.433* (0.230)	D2*OIL 0.222 (0.209)
N/A	N/A	D1*COAL -0.137 (0.195)	D2*COAL -0.208* (0.120)
N/A	N/A	D1*IPI 1.846 (1.147)	D2*IPI 1.970*** (0.680)
N/A	N/A	D1*IR 0.207 (0.136)	D2*IR -0.148 (0.147)
Constant 0.008** (0.004)	Constant 0.009** (0.004)	Constant 0.009** (0.004)	Constant 0.009** (0.004)
Obs. 168	Obs. 168	Obs. 168	Obs. 168
Adj. R² 0.3119	Adj. R² 0.3061	Adj. R² 0.3179	Adj. R² 0.3438

Notes: See note for Table 7.

Table 10 presents the results of regressions conducted for the OBX index return using Formula 6 (Model 2 of Section 4.2.2.) as a basic model:

$$INDEX_t \sim L(INDEX, 1) + GAS_t + COAL_t + OIL_t + IPI_t + IR_t + \varepsilon_t$$

The lagged value of the OBX index return (L(INDEX,1)) suggests a potential negative influence of past performance on the current returns. On the other hand, the variable OIL consistently showed a positive relationship with the INDEX, suggesting that higher OIL was associated with higher stock returns. GAS also demonstrated a positive relationship in

Regressions 1, 2, and 3, but it lost significance in Regression 4. The interaction of OIL with D1 was negative in Regression 3, suggesting that during that period, an increase in OIL was associated with lower index performance. In Regression 4, two interactions became significant: D2 with COAL and D2 with IPI. The former exhibited a 10% level of significance and suggests that an increase in COAL was associated with lower OBX returns. Conversely, the latter had a positive significance at 1%, suggesting that a higher IPI was related to increased performance of the INDEX. In all regressions, the constant term consistently showed significance with positive coefficients.

Table 11. Summary of dynamic regressions performed for the BEL 20 (2008.09 - 2023.01).

(1)	(2)	(3)	(4)
L(Index,1) -0.014 (0.074)	L(Index,1) -0.016 (0.075)	L(Index,1) -0.002 (0.075)	L(Index,1) -0.026 (0.077)
GAS 0.026 (0.022)	GAS 0.027 (0.022)	GAS 0.034 (0.023)	GAS 0.035 (0.028)
OIL 0.155*** (0.043)	OIL 0.156*** (0.044)	OIL 0.160*** (0.045)	OIL 0.154*** (0.047)
COAL -0.075* (0.043)	COAL -0.074* (0.044)	COAL -0.070 (0.049)	COAL -0.083 (0.058)
IPI 0.134 (0.111)	IPI 0.135 (0.112)	IPI 0.131 (0.115)	IPI 0.158 (0.116)
IR -0.008 (0.008)	IR -0.008 (0.008)	IR -0.013 (0.009)	IR -0.006 (0.008)
N/A	D1 -0.008 (0.017)	D1 0.047 (0.101)	N/A
N/A	D2 -0.003 (0.013)	N/A	D2 0.003 (0.016)
N/A	N/A	D1*GAS -0.629 (1.663)	D2*GAS -0.046 (0.050)
N/A	N/A	D1*OIL -0.448 (1.121)	D2*OIL -0.055 (0.188)
N/A	N/A	D1*COAL 0.411 (0.913)	D2*COAL 0.102 (0.099)
N/A	N/A	D1*IPI 1.708 (2.716)	D2*IPI -0.602 (0.463)
N/A	N/A	D1*IR -0.100 (0.462)	D2*IR -0.071 (0.047)
Constant 0.004 (0.003)	Constant 0.004 (0.004)	Constant 0.004 (0.004)	Constant 0.004 (0.004)
Obs. 168	Obs. 168	Obs. 168	Obs. 168
Adj. R² 0.0593	Adj. R² 0.0481	Adj. R² 0.0584	Adj. R² 0.0438

Notes: See note for Table 7.

Table 11 presents the results of regressions conducted for the BEL 20 index return using Formula 6 (Model 2 of Section 4.2.2.) as a basic model:

$$INDEX_t \sim L(INDEX, 1) + GAS_t + COAL_t + OIL_t + IPI_t + IR_t + \varepsilon_t$$

OIL consistently demonstrated a positive relationship with the BEL 20, indicating that higher OIL was associated with higher stock returns. In Regressions 1 and 2, the variable COAL was

significant at the 10% level and was negatively related to the INDEX. This suggest that increases on COAL were associated with negative performance of the BEL 20.

Table 12. Summary of dynamic regressions performed for the FTSE MIB (2008.09 - 2023.01).

(1)		(2)		(3)		(4)	
L(Index,1)	-0.090 (0.077)	L(Index,1)	-0.095 (0.077)	L(Index,1)	-0.093 (0.078)	L(Index,1)	-0.103 (0.079)
GAS	0.053* (0.029)	GAS	0.052* (0.03)	GAS	0.056* (0.031)	GAS	0.052 (0.036)
OIL	0.267*** (0.050)	OIL	0.266*** (0.051)	OIL	0.273*** (0.053)	OIL	0.266*** (0.052)
COAL	-0.198*** (0.057)	COAL	-0.204*** (0.058)	COAL	-0.230*** (0.066)	COAL	-0.144* (0.075)
IPI	-0.075 (0.122)	IPI	-0.071 (0.123)	IPI	-0.065 (0.125)	IPI	-0.072 (0.124)
IR	-0.058* (0.033)	IR	-0.069** (0.035)	IR	-0.066 (0.039)	IR	-0.060* (0.037)
N/A	N/A	D1	0.017 (0.019)	D1	0.039 (0.029)	N/A	N/A
N/A	N/A	D2	0.013 (0.019)	N/A	N/A	D2	0.018 (0.025)
N/A	N/A	N/A	N/A	D1*GAS	-0.241 (0.219)	D2*GAS	0.004 (0.068)
N/A	N/A	N/A	N/A	D1*OIL	-0.342 (0.272)	D2*OIL	-0.053 (0.289)
N/A	N/A	N/A	N/A	D1*COAL	0.374 (0.284)	D2*COAL	-0.147 (0.129)
N/A	N/A	N/A	N/A	D1*IPI	0.747 (1.993)	D2*IPI	0.008 (1.116)
N/A	N/A	N/A	N/A	D1*IR	0.082 (0.115)	D2*IR	-0.049 (0.135)
Constant	0.001 (0.005)	Constant	0.001 (0.005)	Constant	0.00002 (0.005)	Constant	0.0001 (0.005)
Obs.	169	Obs.	169	Obs.	169	Obs.	169
Adj. R²	0.097	Adj. R²	0.093	Adj. R²	0.081	Adj. R²	0.078

Notes: See note for Table 7.

Table 12 presents the results of four dynamic linear regression models for the FTSE MIB index return, based on Formula 6 (Model 2 of Section 4.2.2.):

$$INDEX_t \sim L(INDEX, 1) + GAS_t + COAL_t + OIL_t + IPI_t + IR_t + \varepsilon_t$$

The regressions utilized lagged values of the INDEX itself. The GAS and OIL variables exhibited positive and significant coefficients, indicating a positive relationship with the FTSE MIB index. This suggests that higher levels of GAS and OIL were associated with higher returns in the FTSE MIB. On the other hand, the variables COAL and IR showed a negative association with the FTSE MIB index. Higher COAL prices and increases in IR were found to have a negative association with the performance of the FTSE MIB. GAS maintained its significance in Regressions 1, 2, and 3, while IR demonstrated importance in Regressions 1, 2,

and 4. Overall, the regressions explained around 7.8% to 9.7% of the variance in the FTSE MIB index return.

Table 13. Summary of dynamic regressions performed for the OMXCPI (2008.09 - 2023.01).

(1)		(2)		(3)		(4)	
L(Index,1)	0.013 (0.073)	L(Index,1)	0.012 (0.074)	L(Index,1)	0.072 (0.073)	L(Index,1)	0.055 (0.076)
GAS	0.026 (0.021)	GAS	0.026 (0.021)	GAS	0.016 (0.022)	GAS	0.016 (0.026)
OIL	0.123*** (0.032)	OIL	0.122*** (0.033)	OIL	0.114*** (0.034)	OIL	0.118*** (0.034)
COAL	-0.084** (0.042)	COAL	-0.088** (0.043)	COAL	-0.004 (0.048)	COAL	-0.072 (0.054)
IPI	-0.077 (0.082)	IPI	-0.081 (0.082)	IPI	-0.084 (0.088)	IPI	-0.033 (0.089)
IR	-0.013** (0.006)	IR	-0.012** (0.006)	IR	-0.013 (0.009)	IR	-0.008 (0.006)
N/A	N/A	D1	0.009 (0.014)	D1	0.021 (0.021)	N/A	N/A
N/A	N/A	D2	-0.003 (0.014)	N/A	N/A	D2	0.018 (0.017)
N/A	N/A	N/A	N/A	D1*GAS	-0.133 (0.100)	D2*GAS	-0.018 (0.055)
N/A	N/A	N/A	N/A	D1*OIL	-0.262 (0.202)	D2*OIL	0.290 (0.223)
N/A	N/A	N/A	N/A	D1*COAL	-0.02 (0.131)	D2*COAL	0.084 (0.106)
N/A	N/A	N/A	N/A	D1*IPI	-0.11 (0.316)	D2*IPI	-0.243 (0.299)
N/A	N/A	N/A	N/A	D1*IR	0.004 (0.013)	D2*IR	-0.076* (0.041)
Constant	0.001*** (0.00)	Constant	0.010*** (0.004)	Constant	0.009*** (0.003)	Constant	0.009** (0.004)
Obs.	168	Obs.	168	Obs.	168	Obs.	168
Adj. R2	0.118	Adj. R2	0.109	Adj. R2	0.0822	Adj. R2	0.0683

Notes: See note for Table 7.

Table 13 presents the results of four dynamic linear regression models for the OMXCPI. Regressions were based on basic model represented by Formula 6 (Model 2 of Section 4.2.2.):

$$INDEX_t \sim L(INDEX, 1) + GAS_t + COAL_t + OIL_t + IPI_t + IR_t + \varepsilon_t$$

Across different regressions performed for OMXCPI, the variable OIL consistently showed high significance for explaining the OMXCIP. Its positive coefficient indicates a significant positive relationship between OIL and the INDEX. In regressions 1 and 2, COAL and IR were also important variables, with both exhibiting a negative relationship with the INDEX. This suggests that higher COAL and IR were associated with lower stock returns. However, in Regression 3, the significance of COAL and IR diminished, indicating a weaker relationship

with the INDEX. In Regression 4, the interaction term D2*IR was included, and it showed a negative correlation with the INDEX at a 10% significance level. This suggests that higher IR during that subperiod was associated with lower stock returns. Additionally, across all four regressions, the constant term was positive and highly significant, emphasizing its independent influence on the INDEX regardless of other explanatory variables.

Table 14. Summary of dynamic regressions performed for the AEX (2008.09 - 2023.01).

	(1)	(2)	(3)	(4)
L(INDEX,1)	-0.123 (0.071)	L(INDEX,1) -0.121 (0.072)	L(INDEX,1) -0.125 (0.072)	L(INDEX,1) -0.116 (0.072)
GAS	0.053*** (0.020)	GAS 0.053*** (0.021)	GAS 0.057*** (0.022)	GAS 0.038 (0.025)
OIL	0.181*** (0.039)	OIL 0.181*** (0.032)	OIL 0.186*** (0.041)	OIL 0.179*** (0.040)
COAL	-0.112*** (0.041)	COAL -0.111*** (0.041)	COAL -0.106** (0.049)	COAL -0.069 (0.054)
IPI	0.097 (0.170)	IPI 0.100 (0.171)	IPI 0.092 (0.178)	IPI 0.081 (0.175)
IR	-0.008 (0.011)	IR -0.009 (0.011)	IR -0.020 (0.012)	IR -0.002 (0.012)
N/A	N/A	D1 -0.003 (0.013)	D1 0.020 (0.018)	N/A
N/A	N/A	D2 0.004 (0.013)	N/A	D2 0.010 (0.019)
N/A	N/A	N/A	D1*GAS -0.120 (0.085)	D2*GAS 0.123* (0.067)
N/A	N/A	N/A	D1*OIL -0.205 (0.208)	D2*OIL 0.331 (0.222)
N/A	N/A	N/A	D1*COAL 0.106 (0.123)	D2*COAL -0.329** (0.121)
N/A	N/A	N/A	D1*IPI 0.139 (0.723)	D2*IPI 2.055* (1.009)
N/A	N/A	N/A	D1*IR 0.051 (0.035)	D2*IR -0.123 (0.054)
Constant	0.007** (0.003)	Constant 0.007* (0.004)	Constant 0.007* (0.003)	Constant 0.006* (0.003)
Obs.	168	Obs. 168	Obs. 168	Obs. 168
Adj. R²	0.14	Adj. R² 0.1296	Adj. R² 0.1452	Adj. R² 0.1575

Notes: See note for Table 7.

The regression analysis for AEX that appears in Table 14 were based on Formula 6 (Model 2 of Section 4.2.2.):

$$INDEX_t \sim L(INDEX, 1) + GAS_t + COAL_t + OIL_t + IPI_t + IR_t + \varepsilon_t$$

GAS, COAL, and OIL showed significant coefficients, indicating their association with the AEX. The significant levels of GAS and COAL varied in the last two regressions, while the importance of OIL remained consistent. The highest variations were observed in the last period, as shown in Regression 4. The interactions of the dummy variable D2 with GAS, COAL, and IPI were also found to be significant. During this period, the AEX exhibited a positive

relationship with GAS and IPI, while higher COAL had a detrimental effect on the INDEX's performance. Moreover, the constant term consistently showed significance in all regressions, emphasizing its role as a baseline impact on the AEX.

6. Interpretation and discussion

The results of the analysis show that only a small part of the INDEXes can be explained by changes in other variables in the model. This is proven by the low coefficient of determination of the linear modification of the model. It ranges from 1.5% to 9.6%, depending on the observed country (Table 5). The low value of the dependence is because changes in stock markets are caused by a huge number of factors. Those factors may be both fundamental, driven by political and economic events, as well as behavioral that is associated with decisions based on emotional biases or herd mentality. That might lead to market inefficiencies and irrational stock price movements. Since the results prove that the key changes in the INDEXes in the current period are related to the indicators of the INDEXes in the previous period (Table 6), this speaks in favor of the low level of rationality of the markets in the short term.

We found evidence of the influence of GAS on IPI. However, we did not confirm the significant impact of IPI on INDEXes. Then the output channel is another confirmation of the irrationality of stock markets in the short term. According to the theoretical approach, IPI should affect stock market movements.

An interesting fact is that we proved the significant impact of INDEXes on energy prices in all countries (Table 6 and Figure 13). Considering that our variables are prices of future contracts and not physical deliveries of raw materials, these are alternative investments for market participants. Financial entities such as banks, hedge funds, and commodity trading advisors that do not engage in physical fossil fuel trading are frequently involved in the energy derivatives market to take advantage of price fluctuations. This indicates that financial markets have an impact on the fossil fuels' prices. Additionally, investors have demonstrated a desire to incorporate energy and other commodities into their investment portfolios as a means of diversification or inflation risk mitigation, representing a recent trend.

In addition to the lagged changes in OIL not being a significant variable for the linear modification of the model (Table 5), we also believe that the level of uncertainty is sufficiently significant when considering impulse response functions and forecasting the stock market's

reaction to shocks (Figure 11). By comparing the results of all the tests conducted, including Granger causality, we can conclude with a high degree of confidence that OIL movements do not have a significant impact on stock markets. This is due to the limitations of the analyzed model because we are considering a long horizon in which historical oil shocks are erased. To investigate energy shocks on stock markets, one needs to apply other empirical models and divide the analyzed horizon into oil shocks, as shown in Figure 7. However, this is beyond the scope of our study.

Comparing the results of our thesis with the earlier studies of other authors, we noticed that our hypothesis about an extraordinary jump in gas prices has proven to be correct. Previously, most studies were focused on the investigation of the impact of oil prices on stock markets, which was associated with relatively steady prices in the European gas market. Prior to the suspension of contacts for the supply of Russian gas, European companies significantly hedged their risks by signing long-term gas supply contracts at a price determined by a formula that correlated gas prices with oil prices (Siliverstovs et al., 2005). The purpose of this was to discourage fuel switching to international gas markets and trans-Atlantic suppliers and to have access to cheaper gas. However, after the disruption of gas supply systems in Europe, the sensitivity of stock markets to fluctuations in gas prices seems to exceed the sensitivity to oil price fluctuations.

We have confirmed that there are both direct and indirect relationships between energy prices and stock markets. When we run a linear regression, it became clear that GAS had a more significant impact on stock market INDEXes than other fossil fuels, the IPI, and IR (Table 5). Since most of the countries we analyzed heavily rely on energy imports (Figure 6), it makes sense that a significant increase in GAS would negatively affect economic activity. To understand why we obtained these results, it is important to clarify the specifics of the economy and the level of dependence the countries have on gas.

Germany is heavily dependent on gas imports to meet its energy needs. The country's demand for gas has been steadily increasing over the years due to the phasing out of nuclear power and coal-fired power plants. Before the Russian invasion of Ukraine, Russia accounted for around 40% of the country's gas imports. Currently major suppliers are Norway, the Netherlands, and Denmark. Thus, it is not surprising that, according to the results of all conducted tests, GAS affects the stock market in Germany. By applying variance decomposition, we can see that the gas price is the second largest variable controlling DAX variation in Germany. The impulse response function shows a negative reaction of DAX to a gas shock, confirming the Granger

causality relationship. This dependence on gas imports makes Germany vulnerable to global gas price fluctuations.

France is one of the most dependent nations in the EU on gas imports. Before the middle of 2022, Russia was the main exporter of gas to France, besides Norway, Algeria, and Qatar, which are the largest exporters. In line with Germany, variance decomposition shows that the gas price is the second largest variable controlling CAC 40 variation. The impulse response function shows the negative reaction of CAC 40 on GAS shock, which was confirmed by the Granger causality test. To address its economic dependency on gas imports, France has been exploring alternative energy sources, including renewable energy and energy efficiency measures. Nevertheless, any disruptions on price increases in the global gas market can have significant impacts on the French economy, particularly in energy-intensive sectors such as industry, transportation, and housing.

The UK is reliant on foreign countries for its energy needs. Domestic gas production has been declining for some time, and by 2030, it's projected to meet only 20–25% of the country's demand, with the rest being imported. The majority of the gas imported to the UK comes from Norway, which accounts for around 40% of total imports, followed by Qatar, which supplies around a quarter of the country's gas needs. Other suppliers include the Netherlands, and Russia before the middle of 2022. The significance of the GAS shock's impact on the FTSE 100 is lower than INDEXes in Germany and France, while the level of uncertainty is higher. Additionally, we did not find any impact of GAS on the FTSE 100 according to the Granger causality test. As the UK spends more money on gas imports than it earns from exporting gas, a negative reaction is possible, but the probability is lower compared with Germany and France.

Norway is a major producer and exporter of natural gas, with the third-largest natural gas reserves in Europe. It was the third-largest exporter of natural gas in 2021 and covered about 20–25% of the gas consumption in the EU. As a result, Norway is largely self-sufficient in terms of natural gas and does not depend on gas imports. In 2022, Norwegian gas exports via pipeline experienced a 3.3% uptick, coming close to an all-time high. Germany received the new record volume as Norway aimed to replace the Russian supply. The gas is transported primarily to receiving terminals in France, Belgium, Germany, and the UK, with the latest addition being a pipeline to Poland through Denmark. Deliveries to Germany shot up by 11% to 54.8 bcm year-on-year, while France experienced a 4.7% increase. This shift eastward is expected to continue in 2023 as Norway focuses on improving the security of its pipeline

infrastructure. We observe that GAS mainly affects OBX through IR and COAL, which Norway also exports for the production of steel in Europe (Russian exports of coal were banned in 2022). One of the biggest contributors to OBX are oil and gas companies, including Equinor, the largest oil and gas company in Europe. During autumn 2022, Equinor's share price reached its historic high, 401 NOK, which was more than doubled compared to autumn 2021. To predict the OBX's response on GAS shock in future, we noted that our model confirms mainly positive response.

Belgium relies heavily on gas imports to fulfill its energy needs. This is because Belgium has limited natural gas reserves only, and its domestic production is very low. Currently, Belgium imports gas mainly from three sources: the Netherlands, Norway, and Qatar. Before the middle of 2022, Russia was the fourth, but not the main, exporter and accounted for around 10%. The Netherlands is the biggest supplier, providing around 40% of Belgium's gas imports, followed by Norway, which provides around 25%, and Qatar, which provides around 20%. Belgium's gas consumption is mostly for heating buildings, generating electricity, and industrial processes. According to the results of all tests, there may be a slightly negative reaction from BEL 20 to the rise of GAS; nevertheless, its probability is quite low. Despite the high level of dependence of Belgium's economy on gas imports, we did not confirm the relationships. Most likely, our findings are due to the specificity of the BEL 20 itself. Firstly, it only includes 20 companies, and secondly, the composition is revised quarterly. Nevertheless, we confirmed the impact of GAS shocks on the increase in IR.

Italy depends on gas imports to meet its energy needs. Currently Italy imports natural gas, mainly from Norway, Algeria, Libya, and the Netherlands. Russia was the main exporter until the middle of 2022. The country's dependency on gas imports has been a major concern for its energy security and has led policymakers to diversify its energy mix by promoting renewable energy sources such as wind and solar power. By running our tests, we see that GAS shocks cause a negative reaction in FTSE MIB, mainly through an indirect channel, namely IR.

Denmark depends on gas imports to a minimal extent, with the lowest level of dependence among the analyzed countries. In addition to having its own oil and gas fields, Denmark has also succeeded in transforming its energy sector towards renewable sources of energy. Most of the natural gas that Denmark consumes is imported from Norway via pipelines, while a small portion is imported as LNG from other countries, such as Qatar and the United States. The

results of all tests confirm the knowledge of a low level of dependence on gas imports and indicate the absence of any influence of GAS on OMXCPI.

The Netherlands still depends on gas imports despite being a major exporter of natural gas in the past. The country's gas production has been declining in recent years, and as a result, it has turned to importing gas from other countries, mostly supplied by Russia. Although domestic gas supply and export are declining, the Netherlands remains one of the largest producers in Europe. Currently most of the gas imports come from Norway, and other European countries. The Netherlands also has several import terminals for LNG to supplement its gas supply. According to our results, AEX might react negatively to GAS shocks, nevertheless, the reaction is weak, and the level of uncertainty is high. This finding confirms the low level of the country's dependency on gas imports.

A comparison of pre-invasion and post-invasion periods shows a slight increase in the coefficients of determination for most countries, namely Germany, France, the UK, Norway, and the Netherlands, and a decrease in Belgium, Italy, and Denmark. In both periods, OIL had the most significant relationship with INDEXes. Both intervals are characterized by a significant rise in OIL, taking into account the unprecedented price drop during the COVID-19 pandemic; for example, oil prices were negative in the USA. After the pandemic, when OPEC and Russia reached an agreement to reduce production volumes and offer discounts on oil and lockdowns were lifted, demand for oil increased significantly. However, no new wells were developed during the pandemic. This led to optimism in the oil and gas markets and a positive correlation with simultaneously growing financial markets.

We did not confirm a direct impact of the invasion on the stock markets of the countries analyzed. However, we observe a decrease in the stock markets' dependence on GAS and COAL. Tension on the financial markets began in August 2021 due to delayed gas deliveries and corresponding uncertainty on the markets (Figure 9). Because of the gas shortage, coal prices increased as well. INDEXes began to show positive dynamics again after European countries reduced their gas consumption and new contracts were signed for alternative natural gas supplies from Norway and LNG (Autumn 2022). DLM was not intended to investigate gas shock influences. It has only shown the changes in associations, considering that in both periods under investigation there was balance and imbalance in demand and supply on gas markets. The outcomes of the VAR model and DLM cannot be compared in this study because of the different assumptions used in both methods.

7. Conclusions

This Master's thesis investigated the relationships between fossil fuel prices and the stock markets of eight European financial markets. Based on the concept of the rationality of the stock market, we tested how the stock markets reflect the true value of companies and the future prospects of the economy through changes in input costs and fossil fuel revenues. The study provides evidence about relationships between fossil fuels, especially GAS, and stock market movements.

Stock markets under investigation showed low rationality in the short run. INDEXes react weakly to fundamental factors, which theoretically speaking should be a driving force for stock markets' movements. Innovations in stock returns are primarily explained by their own shocks.

We confirmed the influence of GAS shocks on stock markets and vice versa. The influence of GAS on stock markets varies from country to country and is determined by the economy's dependence on gas. In turn, the influence of INDEXes on GAS can be explained by investors' desire to diversify their investment portfolio.

We also confirmed with a high degree of confidence that GAS affects stock markets in Germany and France through a direct channel. In Norway and Italy, GAS mainly influences stock markets through a monetary channel. In most countries, GAS affects the IPI and in all countries, GAS affects the IR.

The reactions of the stock markets to a possible future GAS increase can be summarized as follows. The INDEXes in Germany, France will react negatively. The INDEX in Norway will react positively. The INDEXes in Belgium, the UK and Italy will react negatively, but the level of uncertainty is high. The INDEXes in Denmark and the Netherlands will not react to a GAS shock.

We concluded that COVID-19 pandemic and gas shock had affected the relationships between fossil fuels and stock markets. The interdependence between gas and stock price changes increased and the emphasis on importance shifted from oil to gas due to the extraordinary gas supply shortage.

We can state that the Russian invasion of Ukraine alone did not have a significant impact on the relationship between fossil fuels and stock markets. Nevertheless, we proved that this event

coincided with turbulence in the energy markets and the supply and demand imbalance that caused a change in relationships.

Including possible changes in gas prices in financial models might improve the accuracy of stock market movement predictions.

8. Future work

To further investigate relationships between gas and stock markets, it will be interesting to identify and compare various shock events with different natures of occurrence, specifically supply and demand shocks. The two latest global events for the European economy appear to be attractive for more detailed examination. The COVID-19 pandemic is characterized by a demand shock, wherein the demand for all fossil fuels decreased, resulting in a corresponding decrease in the price of gas, which was artificially manipulated. This demand shock began in the winter of 2020 and ended in the autumn of 2020 (as per OPEC's agreement on production volumes). The problems with Russian gas supplies are of a supply-shock nature. This shock began in July 2021, when Russia began to violate its usual gas supplies, and ended in August 2022 (as per the agreement of European countries to reduce dependence on Russian gas).

Since we have demonstrated a connection between GAS and stock markets, further research on the impact on specific industries and companies looks promising. Considering the factors contributing to the continuation of the gas crisis and the expected extended period for establishing new gas supply routes, we anticipate continued high volatility in energy prices.

Given that we are observing a change in Europe's energy landscape, which is under pressure from society and disrupted by supply shortages, studying the transition to sustainable energy sources appears to be promising. This vast field of research will be the most popular in the next decade. Opportunities for sustainable finance research are also expanding in this direction. For example, it could involve studying the relationships between the cost of renewable energy companies' stocks and energy market volatility. This might provide interesting new insights into the transition to a more sustainable future.

References

- Acaravci, A., Ozturk, I., & Kandir, S. Y. (2012). Natural gas prices and stock prices: Evidence from EU-15 countries. *Economic Modelling*, 29(5), 1646–1654. <https://doi.org/10.1016/j.econmod.2012.05.006>
- Ahmed, W. M. A. (2018). On the interdependence of natural gas and stock markets under structural breaks. *Quarterly Review of Economics and Finance*, 67, 149–161. <https://doi.org/10.1016/j.qref.2017.06.003>
- Al-hajj, E., Al-Mulali, U., & Solarin, S. A. (2018). Oil price shocks and stock returns nexus for Malaysia: Fresh evidence from nonlinear ARDL test. *Energy Reports*, 4, 624–637. <https://doi.org/10.1016/j.egy.2018.10.002>
- Alpanda, S., & Peralta-Alva, A. (2010). Oil crisis, energy-saving technological change and the stock market crash of 1973-74. *Review of Economic Dynamics*, 13(4), 824–842. <https://doi.org/10.1016/j.red.2010.04.003>
- Antonakakis, N., Chatziantoniou, I., & Filis, G. (2017). Oil shocks and stock markets: Dynamic connectedness under the prism of recent geopolitical and economic unrest. *International Review of Financial Analysis*, 50, 1–26. <https://doi.org/10.1016/j.irfa.2017.01.004>
- Apergis, N., & Miller, S. M. (2009). Do structural oil-market shocks affect stock prices? *Energy Economics*, 31(4), 569–575. <https://doi.org/10.1016/j.eneco.2009.03.001>
- Atif, M., Raza Rabbani, M., Bawazir, H., Hawaldar, I. T., Chebab, D., Karim, S., & AlAbbas, A. (2022). Oil price changes and stock returns: Fresh evidence from oil exporting and oil importing countries. *Cogent Economics and Finance*, 10(1). <https://doi.org/10.1080/23322039.2021.2018163>
- Barsky, R. B., & Kilian, L. (2004). Oil and the macroeconomy since the 1970s. *Journal of Economic Perspectives*, 18(4), 115–134. <https://doi.org/10.1257/0895330042632708>
- Basher, S. A., & Sadorsky, P. (2006). Oil price risk and emerging stock markets. *Global Finance Journal*, 17(2), 224–251. <https://doi.org/10.1016/j.gfj.2006.04.001>
- Bjørnland, H. C. (2009). Oil price shocks and stock market booms in an oil exporting country. *Scottish Journal of Political Economy*, 56(2), 232–254. <https://doi.org/10.1111/j.1467-9485.2009.00482.x>
- Bohi, D. R. (1991). On the macroeconomic effects of energy price shocks. *Resources and Energy*, 13(2), 145–162. [https://doi.org/10.1016/0165-0572\(91\)90012-R](https://doi.org/10.1016/0165-0572(91)90012-R)
- Bouri, E. (2015). Oil volatility shocks and the stock markets of oil-importing MENA economies: A tale from the financial crisis. *Energy Economics*, 51, 590–598. <https://doi.org/10.1016/j.eneco.2015.09.002>
- Creti, A., Joëts, M., & Mignon, V. (2013). On the links between stock and commodity markets' volatility. *Energy Economics*, 37, 16–28. <https://doi.org/10.1016/j.eneco.2013.01.005>
- Degiannakis, S., Filis, G., & Arora, V. (2018a). Oil prices and stock markets: A review of the theory and empirical evidence. *Energy Journal*, 39(5), 85–130. <https://doi.org/10.5547/01956574.39.5.sdeg>

- Edelstein, P., & Kilian, L. (2009). How sensitive are consumer expenditures to retail energy prices? *Journal of Monetary Economics*, 56(6), 766–779. <https://doi.org/10.1016/j.jmoneco.2009.06.001>
- El, M., Arouri, H., & Nguyen, D. K. (2010). Oil Prices, Stock Markets and Portfolio Investment: Evidence from Sector Analysis in Europe over the Last Decade. *Energy policy*, 38 (8), 4528-4539. <https://doi.org/10.1016/j.enpol.2010.04.007>
- Filis, G. (2010). Macro economy, stock market and oil prices: Do meaningful relationships exist among their cyclical fluctuations? *Energy Economics*, 32(4), 877–886. <https://doi.org/10.1016/j.eneco.2010.03.010>
- Filis, G., & Chatziantoniou, I. (2014). Financial and monetary policy responses to oil price shocks: Evidence from oil-importing and oil-exporting countries. *Review of Quantitative Finance and Accounting*, 42(4), 709–729. <https://doi.org/10.1007/s11156-013-0359-7>
- Gatfaoui, H. (2016). Linking the gas and oil markets with the stock market: Investigating the U.S. relationship. *Energy Economics*, 53, 5–16. <https://doi.org/10.1016/j.eneco.2015.05.021>
- Ghorbel, A., & Jeribi, A. (2021). Volatility spillovers and contagion between energy sector and financial assets during COVID-19 crisis period. *Eurasian Economic Review*, 11(3), 449–467. <https://doi.org/10.1007/s40822-021-00181-6>
- Gjerde, Ø., & Sættem, F. (1999). Causal relations among stock returns and macroeconomic variables in a small, open economy. *Journal of International Financial Markets, Institutions and Money*, 9(1), 61–74. [https://doi.org/10.1016/S1042-4431\(98\)00036-5](https://doi.org/10.1016/S1042-4431(98)00036-5)
- Hamilton, J. D. (1996). This is what happened to the oil price - Macroeconomy relationship. *Journal of Monetary Economics*, 38(2), 215–220. [https://doi.org/10.1016/S0304-3932\(96\)01282-2](https://doi.org/10.1016/S0304-3932(96)01282-2)
- Hamilton, J. D. (2003). What is an oil shock? *Journal of Econometrics* (Vol. 113). www.elsevier.com/locate/econbase
- Hatemi-J, A., Al Shayeb, A., & Roca, E. (2017). The effect of oil prices on stock prices: fresh evidence from asymmetric causality tests. *Applied Economics*, 49(16), 1584–1592. <https://doi.org/10.1080/00036846.2016.1221045>
- Huang, R. D., Masulis, R. W., & Stoll, H. R. (1996). Energy Shocks and Financial Markets. *Journal of Futures Markets* (Vol. 16, Issue 1).
- Jiang, Z., & Yoon, S. M. (2020). Dynamic co-movement between oil and stock markets in oil-importing and oil-exporting countries: Two types of wavelet analysis. *Energy Economics*, 90. <https://doi.org/10.1016/j.eneco.2020.104835>
- Jiménez-Rodríguez, R., & Sánchez, M. (2005). Oil price shocks and real GDP growth: Empirical evidence for some OECD countries. *Applied Economics*, 37(2), 201–228. <https://doi.org/10.1080/0003684042000281561>
- Khalfaoui, R., Boutahar, M., & Boubaker, H. (2015). Analyzing volatility spillovers and hedging between oil and stock markets: Evidence from wavelet analysis. *Energy Economics*, 49, 540–549. <https://doi.org/10.1016/j.eneco.2015.03.023>

- Khan, K., Su, C. W., & Zhu, M. N. (2022). Examining the behaviour of energy prices to COVID-19 uncertainty: A quantile on quantile approach. *Energy*, 239. <https://doi.org/10.1016/j.energy.2021.122430>
- Kilian, L. (2009). Not all oil price shocks are alike: Disentangling demand and supply shocks in the crude oil market. *American Economic Review*, 99(3), 1053–1069. <https://doi.org/10.1257/aer.99.3.1053>
- Kilian, L., & Park, C. (2009). The impact of oil price shocks on the U.S. stock market. *International economic review*, 50(4), 425–430. <https://doi.org/10.1201/b18660-95>
- Kumar, S., Pradhan, A. K., Tiwari, A. K., & Kang, S. H. (2019). Correlations and volatility spillovers between oil, natural gas, and stock prices in India. *Resources Policy*, 62, 282–291. <https://doi.org/10.1016/j.resourpol.2019.04.004>
- Lee, B.-S. (1992). Causal relations among stock returns, interest rates, real activity, and inflation. *The Journal of Finance*, 47(4), 1591–1603. <https://www-jstor-org.ezproxy.uis.no/stable/2328955?sid=primo&origin=crossref>
- Lin, L., Zhou, Z., Liu, Q., & Jiang, Y. (2019). Risk transmission between natural gas market and stock markets: portfolio and hedging strategy analysis. *Finance Research Letters*, 29, 245–254. <https://doi.org/10.1016/j.frl.2018.08.011>
- Mensi, W., Rehman, M. U., Maitra, D., Al-Yahyaee, K. H., & Vo, X. V. (2021). Oil, natural gas and BRICS stock markets: Evidence of systemic risks and co-movements in the time-frequency domain. *Resources Policy*, 72. <https://doi.org/10.1016/j.resourpol.2021.102062>
- Mohanty, S. K., & Nandha, M. (2011). Oil risk exposure: The case of the U.S. oil and gas sector. *Financial Review*, 46(1), 165–191. <https://doi.org/10.1111/j.1540-6288.2010.00295.x>
- Nath Sahu, T., Bandopadhyay, K., & Mondal, D. (2014). An empirical study on the dynamic relationship between oil prices and Indian stock market. *Managerial Finance*, 40(2), 200–215. <https://doi.org/10.1108/MF-06-2013-0131>
- Oberndorfer, U. (2009). Energy prices, volatility, and the stock market: Evidence from the Eurozone. *Energy Policy*, 37(12), 5787–5795. <https://doi.org/10.1016/j.enpol.2009.08.043>
- Olubusoye, O. E., Akintande, O., Yaya, O. S., Ogbonna, A. E., Akintande, O. J., Yaya, O. S., Ogbonna, A. E., & Adenikinju, A. F. (2021). Energy pricing during the COVID-19 pandemic: Predictive information-based uncertainty indexes with machine learning algorithm. *International Journal of Intelligent Systems and Applications*, 12, 50. <https://doi.org/10.1016/j.iswa.2021.20>
- Park, J., & Ratti, R. A. (2008). Oil price shocks and stock markets in the U.S. and 13 European countries. *Energy Economics*, 30(5), 2587–2608. <https://doi.org/10.1016/j.eneco.2008.04.003>
- Rasche, R. H., & Tatom, J. A. (1981). Energy price shocks, aggregate supply and monetary policy: The theory and the international evidence. *Carnegie-Rochester Confer. Series on Public Policy*, 14(C), 9–93. [https://doi.org/10.1016/0167-2231\(81\)90002-6](https://doi.org/10.1016/0167-2231(81)90002-6)
- Sadorsky, P. (1999). Oil price shocks and stock market activity. *Energy Economics*, 21(5), 449–

469. [https://doi.org/10.1016/S0140-9883\(99\)00020-1](https://doi.org/10.1016/S0140-9883(99)00020-1)

Scholtens, B., & Yurtsever, C. (2012). Oil price shocks and European industries. *Energy Economics*, 34(4), 1187–1195. <https://doi.org/10.1016/j.eneco.2011.10.012>

Siliverstovs, B., L'Hégaret, G., Neumann, A., & von Hirschhausen, C. (2005). International market integration for natural gas? A cointegration analysis of prices in Europe, North America and Japan. *Energy Economics*, 27(4), 603–615. <https://doi.org/10.1016/j.eneco.2005.03.002>

Villar, J. A., & Joutz, F. L. (2016). Energy Information Administration, Office of Oil and Gas, The Relationship Between Crude Oil and Natural Gas Prices. *Energy Information Administration*, 1(8), 1–43.

Wongbangpo, P., & Sharma, S. C. (2002). Stock market and macroeconomic fundamental dynamic interactions: ASEAN-5 countries. *Journal of Asian Economics*, 13(1), 27–51. [https://doi.org/10.1016/S1049-0078\(01\)00111-7](https://doi.org/10.1016/S1049-0078(01)00111-7)

Appendices

Appendix 1. The details about chosen INDEXes

The DAX 30 (DAX) is the leading stock market index of Germany. It represents the performance of the 30 largest and most actively traded blue-chip companies listed on the Frankfurt Stock Exchange, measured by market capitalization and order book volume. The DAX was established in 1988 with a base value of 1.000 and has since become a benchmark for the German economy and a popular international investment instrument. The index is maintained and calculated by Deutsche Börse AG and is reviewed quarterly to ensure its composition remains up-to-date with the changing market landscape. The companies in the DAX cover a variety of sectors, including automotive, manufacturing, technology, healthcare, financial services, and consumer goods. Some of the most well-known DAX constituents include Volkswagen, Siemens, Allianz, SAP, and Deutsche Bank. The DAX is often used as an indicator of the health of the German economy, as well as a barometer of the broader European market. It is widely traded on futures and options exchanges around the world and is also the underlying index for a number of exchange-traded funds (ETFs) and other investment products.

The CAC 40 is a benchmark stock market index that tracks the performance of the top 40 companies listed on the Euronext Paris exchange in France. The companies included in the index cover various sectors, including finance, energy, consumer goods, healthcare, and more. The CAC 40 is considered a barometer of the performance of the French economy and is widely watched by investors around the world. The index is calculated in real-time, and its constituents are reviewed quarterly to ensure that the companies listed accurately reflect the current state of the French stock market. There is one (Total Energies SE) Oil and Gas producers' stock in the CAC 40.

The Financial Times Stock Exchange 100 Index (FTSE100) is a market capitalization weighted index of the 100 largest companies listed on the London Stock Exchange. It is widely used as a benchmark for the performance of the UK stock market and is seen as an indicator of the performance of the UK economy. The FTSE100 was first calculated in January 1984 and is often referred to simply as the "Footsie". The index is reviewed quarterly to ensure that the companies included continue to represent the largest and most liquid companies in the UK market. The constituents are selected based on their market capitalization, with only companies that meet certain criteria for size, liquidity and free float being considered for inclusion. The

FTSE100 is an important index for investors looking to gain exposure to the UK market and is also widely used as a basis for index-linked products, such as exchange-traded funds (ETFs) and other derivatives. There are 2 Oil and Gas producers' stocks in the FTSE100.

The OBX Index is a stock market index of Norway's Oslo Stock Exchange (OSE) launched on April 22, 1991. It comprises the 25 most active stocks trading on the exchange with more than 10% of the total trading activity. OBX is known for its narrow framework and high liquidity making it very appealing to investors who want to invest in a reputation-backed instrument with low risk. Essentially, the index is used to track the performance of the Norwegian stock market's blue-chip stocks representing different industries, including the energy, shipping, banking, telecom, and retail sectors, 7 of those are Oil and Gas producers.

The BEL 20 is a Belgian stock market index that is comprised of the top 20 companies listed on the Brussels stock exchange, based on their market capitalization. The index is weighted by market capitalization, meaning that companies with larger market values have a greater impact on the index's performance. The BEL 20 was created in 1991 and is maintained by Euronext Brussels, a subsidiary of Euronext N.V., a pan-European exchange group. The index is reviewed four times a year to ensure that it continues to reflect the current state of the Belgian economy. Some of the companies included in the BEL 20 are large multinational corporations such as AB InBev, UCB, and Solvay, as well as Belgian banks and financial institutions like KBC and ING Belgium. The BEL 20 is considered an important indicator of the health of the Belgian economy and is closely watched by investors both inside and outside of Belgium.

The FTSE MIB index is a stock market index consisting of the 40 most actively traded companies listed on the Borsa Italiana, the main stock exchange in Italy. The index covers roughly 80% of the total market capitalization of Italy's stock market. The FTSE MIB index represents a variety of sectors, including financial services, energy, telecommunications, consumer goods, and industrial goods. The index is weighted by market capitalization, with larger companies contributing more to the index's movements than smaller ones. The constituents of the FTSE MIB index are reviewed quarterly, with changes to the companies included based on their performance and market capitalization. The FTSE MIB index is a widely cited benchmark for the Italian stock market, providing investors with insight into the overall health of Italian companies and the Italian economy. It is also used as a basis for financial products such as exchange-traded funds and futures contracts. Eni, Snam and Saipem are companies related to oil and gas and are included in the index.

The OMX Copenhagen Stock Exchange (OMXCPI) is the primary stock market index of Denmark. It measures and tracks the performance of the Danish stock market and is made up of the 25 most actively traded stocks on the Copenhagen Stock Exchange. The index is market capitalization-weighted, which means that the larger the company's market capitalization, the more weight it carries in the index. The index is rebalanced quarterly to ensure that it stays up to date with changes in the market and the prices of the constituent stocks. The OMXCPI reflects the performance of the Danish economy and is used by investors to track the performance of the Danish stock market and make investment decisions.

The AEX index is a benchmark index for Amsterdam Stock Exchange (AEX). The weight of its 25 constituents holds the same proportion of its market capitalization. Widely used as performance benchmark by investors. The composition is adjusted quarterly. AEX index covers a wide range of industries, currently with information technology being the top sector. Among the companies that make up the index is Royal Dutch Shell, which, within its diversified portfolio, is dedicated to the production and export of oil and gas.

Appendix 2. Descriptive statistics of INDEXes in level (2008.09 - 2023.01).

Indicators	DAX	CAC 40	FTSE 100	OBX	BEL20	FTSE MIB	OMXCPI	AEX
Mean	10053.83	4664.12	2661.57	65.64	3182.89	20399.28	95.83	466.03
Standard Error	238.62	79.99	33.48	1.66	51.24	230.28	3.54	10.86
Median	10511.02	4509.26	2717.60	63.14	3345.63	20659.46	99.04	450.39
Standard Deviation	3138.49	1052.09	440.40	21.80	674.01	3028.90	46.50	142.86
Kurtosis	-1.07	-0.62	-0.55	-0.16	-1.12	-0.45	-0.59	-0.55
Skewness	-0.11	0.38	-0.19	0.32	-0.33	-0.16	0.55	0.49
Range	12041.12	4450.55	2014.98	97.32	2613.57	14472.99	171.30	593.93
Minimum	3843.74	2702.48	1546.92	20.51	1696.58	12873.84	27.83	216.98
Maximum	15884.86	7153.03	3561.90	117.83	4310.15	27346.83	199.13	810.91
ADF test	-3.798**	-3.365*	-3.272*	-3.289*	-3.145*	-2.999	-1.841	-3.088

Note: One, two, or three asterisks indicate significance at a 10%, 5%, or 1% level, respectively.

Appendix 3. The dynamics of stock index returns

A) DAX return, % (Germany)

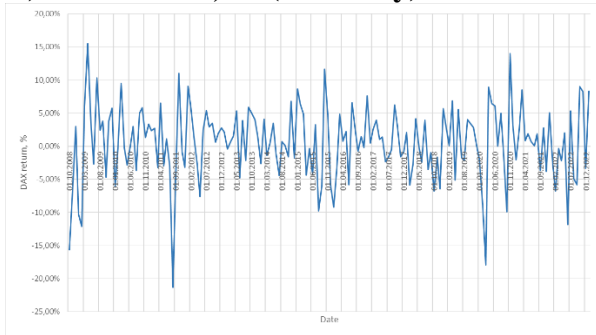

B) CAC 40 return, % (France)

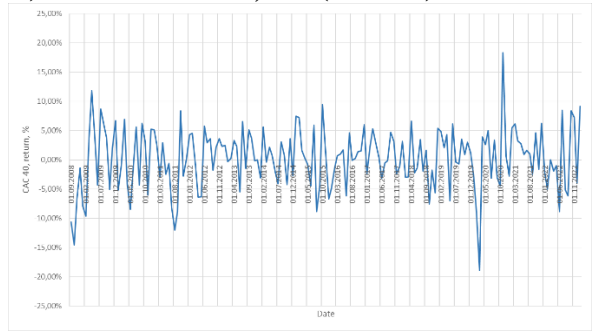

C) FTSE 100 return, % (UK)

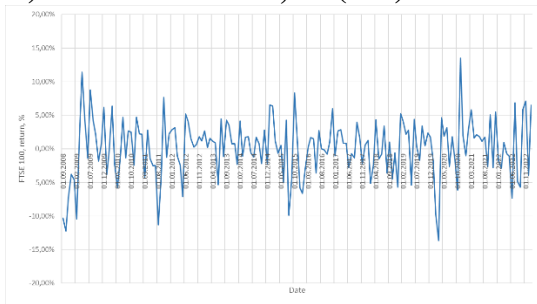

D) OBX return, % (Norway)

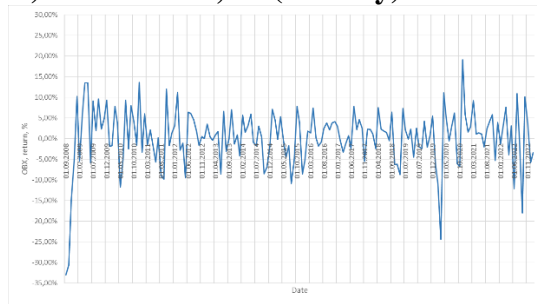

E) BEL 20 return, % (Belgium)

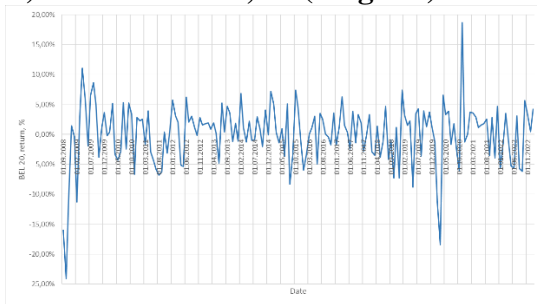

F) FTSE MIB return, % (Italy)

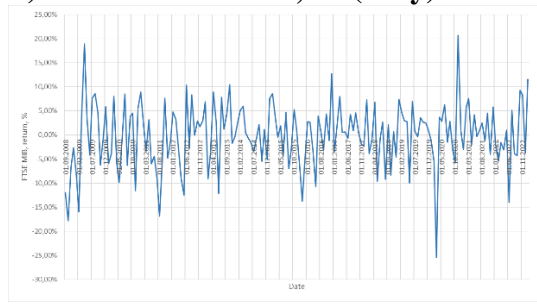

G) OMXCPI return, % (Denmark)

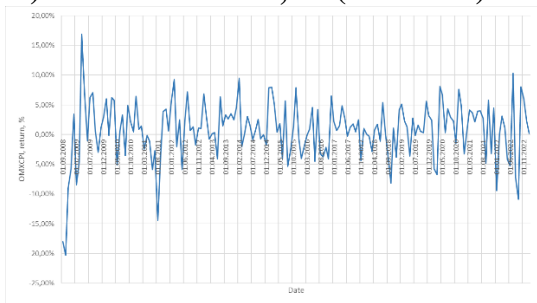

H) AEX return, % (Netherlands)

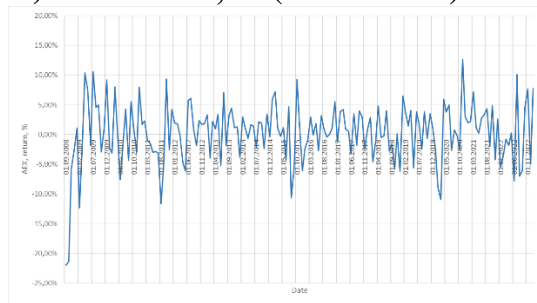

Appendix 4. Descriptive statistics of fossil fuel prices in level (2008.09 - 2023.01).

Indicators	GAS	OIL	COAL
Mean	28.55	62.59	76.75
Standard Error	2.52	1.42	3.27
Median	20.45	59.51	64.67
Standard Deviation	33.14	18.74	42.95
Kurtosis	19.77	-0.55	12.26
Skewness	4.07	0.27	3.39
Range	257.37	93.83	268.41
Minimum	3.63	20.62	34.86
Maximum	261.00	114.45	303.27
ADF test	-14.07***	-2.71	-8.66***

Note: One, two, or three asterisks indicate significance at a 10%, 5%, or 1% level, respectively.

Appendix 5. Descriptive statistics of IR in first differences (2008.09 - 2023.01).

Indicators	Germany	France	UK	Norway	Belgium	Italy	Denmark	Netherlands
Mean	-0.0001	-0.0001	-0.0001	-0.0001	-0.0001	0.0000	-0.0001	-0.0001
Standard Error	0.0001	0.0001	0.0002	0.0001	0.0001	0.0002	0.0001	0.0001
Median	-0.0004	-0.0003	0.0000	-0.0002	-0.0004	-0.0004	-0.0003	-0.0002
Standard Deviation	0.0017	0.0018	0.0020	0.0017	0.0019	0.0028	0.0019	0.0017
Sample Variance	0.0000	0.0000	0.0000	0.0000	0.0000	0.0000	0.0000	0.0000
Kurtosis	3.0752	1.9699	7.0298	0.4862	2.0813	1.9796	2.7326	4.1011
Skewness	0.6327	0.8563	0.8699	-0.2878	0.9329	0.6384	0.6582	1.1275
Range	0.0129	0.0116	0.0187	0.0104	0.0123	0.0208	0.0138	0.0126
Minimum	-0.0053	-0.0044	-0.0069	-0.0064	-0.0049	-0.0099	-0.0056	-0.0050
Maximum	0.0076	0.0072	0.0117	0.0040	0.0074	0.0109	0.0083	0.0077
ADF test	-5.089***	-5.161***	-5.110***	-4.535***	-4.383***	-4.505***	-4.739***	-4.744***

Note: One, two, or three asterisks indicate significance at a 10%, 5%, or 1% level, respectively.

Appendix 6: Results of the partial autocorrelation study

Fossil fuel

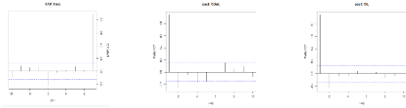

INDEXes

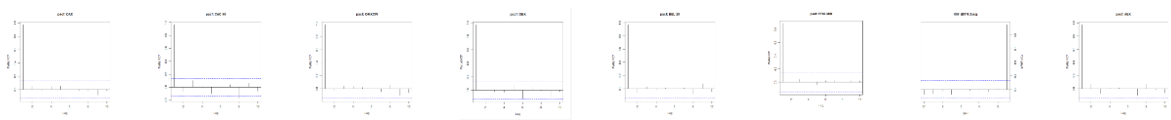

IPI

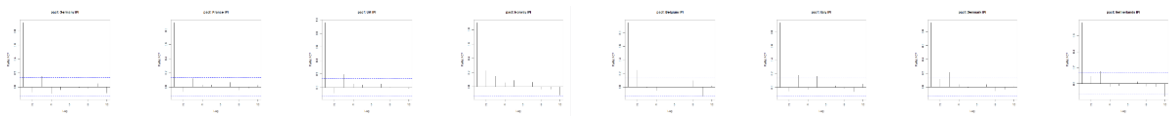

IR

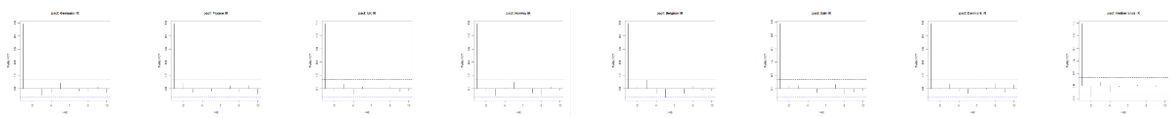

Appendix 7. Impulse response function of IPI growth to INDEXes

A) DAX (Germany)

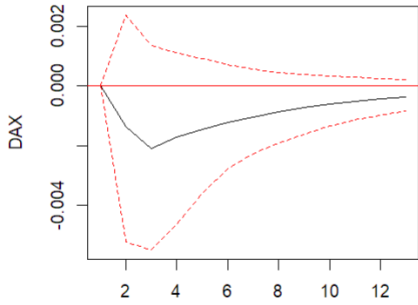

B) CAC 40 (France)

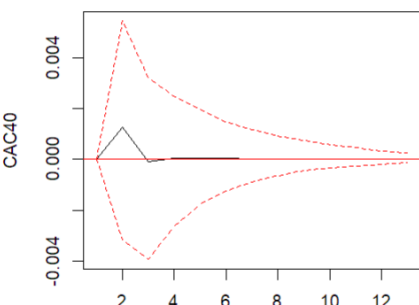

C) FTSE 100 (UK)

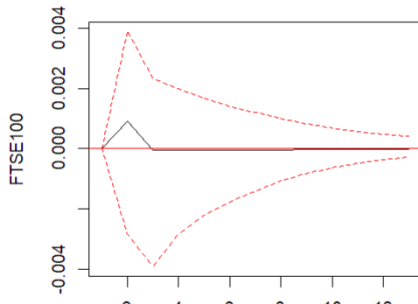

D) OBX (Norway)

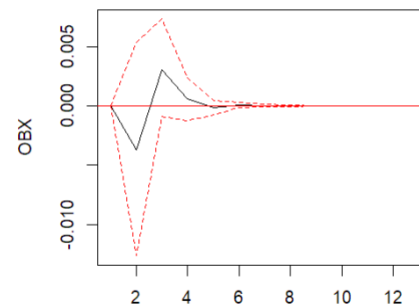

E) BEL 20 (Belgium)

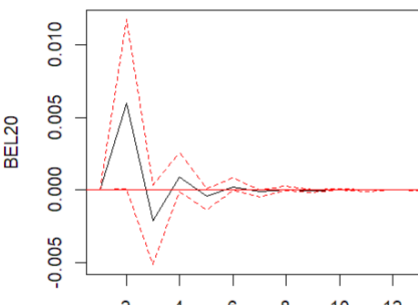

F) FTSE MIB (Italy)

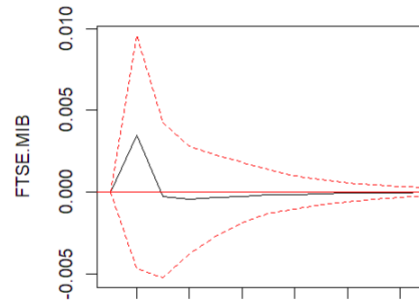

G) OMXCPI (Denmark)

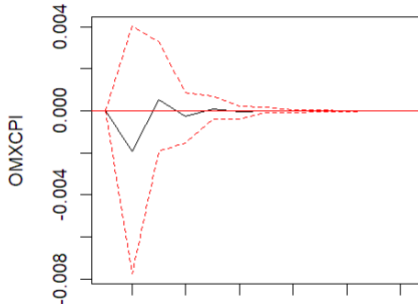

H) AEX (Netherlands)

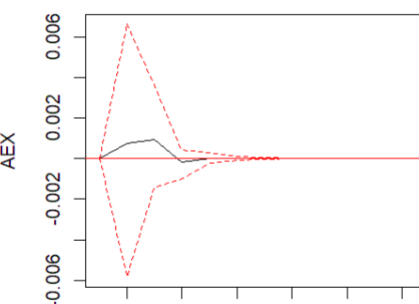

Appendix 8. Impulse response function of IR growth to INDEXes

A) DAX (Germany)

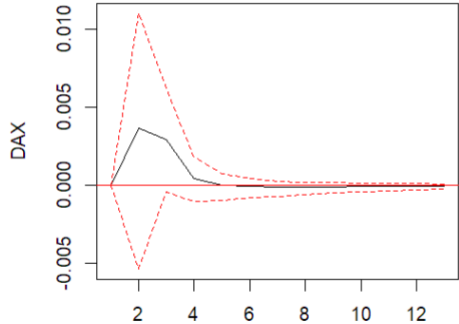

B) CAC 40 (France)

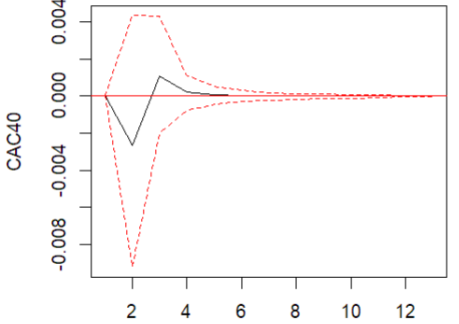

C) FTSE 100 (UK)

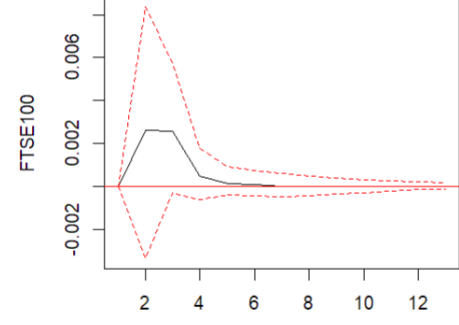

D) OBX (Norway)

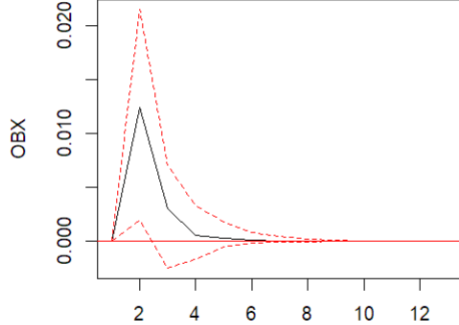

E) BEL 20 (Belgium)

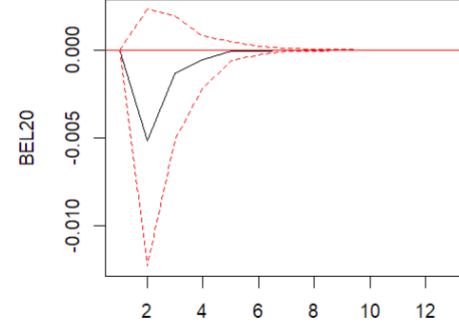

F) FTSE MIB (Italy)

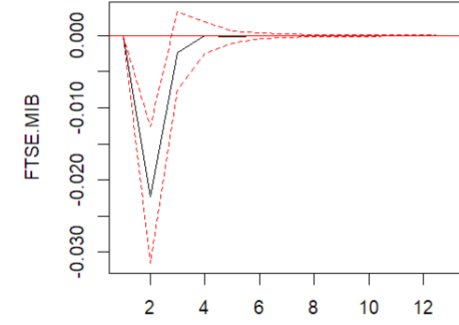

G) OMXCPI (Denmark)

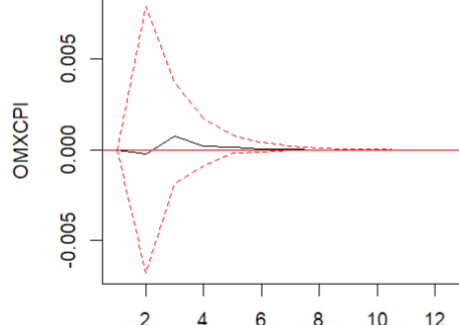

G) AEX (Netherlands)

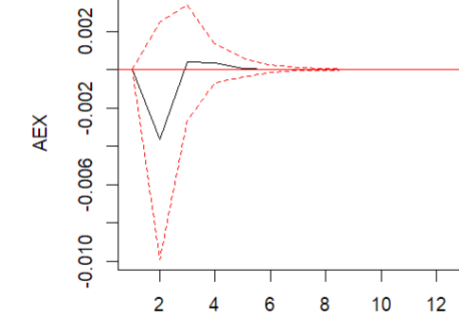

Appendix 9. Results of the Granger causality tests

Lags	1	2	3	4	6	8	10	12
DAX								
GAS → INDEX	0.0303 *	0.2448	0.3997	0.3357	0.6941	0.7071	0.7049	0.6209
GAS → IPI	0.4804	0.0574	0.0693	0.1221	0.1783	0.0421 *	0.0112 *	0.0245 *
GAS → IR	0.3660	0.1226	0.1135	0.1729	0.0085**	0.0035**	0.0008***	0.0034**
OIL → INDEX	0.5614	0.5429	0.8525	0.4231	0.1986	0.1677	0.2343	0.1668
OIL → IPI	0.0715	0.4855	0.1620	0.3012	0.7361	0.6872	0.0033**	0.0000***
OIL → IR	0.8631	0.6910	0.8800	0.8487	0.8110	0.8758	0.9358	0.9613
COAL → INDEX	0.7400	0.9071	0.7315	0.8081	0.6938	0.9342	0.8428	0.6300
COAL → IPI	0.5322	0.6105	0.2475	0.3951	0.8043	0.8988	0.9582	0.3084
COAL → IR	0.0261*	0.0100**	0.0038**	0.0032**	0.0013**	0.0000***	0.0000***	0.0000***
INDEX → GAS	0.0027**	0.0062**	0.0246*	0.0159*	0.0928	0.1780	0.1975	0.1210
INDEX → OIL	0.05194	0.2556	0.2556	0.1492	0.2730	0.1848	0.4817	0.6435
INDEX → COAL	0.0301 *	0.0625	0.1784	0.2744	0.5397	0.5542	0.5051	0.3814
INDEX → IPI	0.255	0.938	0.2302	0.2951	0.3923	0.4887	0.2316	0.3311
INDEX → IR	0.6475	0.5831	0.4116	0.6493	0.6227	0.9555	0.9569	0.4048
IPI → INDEX	0.3446	0.5886	0.6116	0.6928	0.9047	0.4960	0.4859	0.5077
IR → INDEX	0.2071	0.2720	0.4767	0.5888	0.6578	0.8380	0.6782	0.7727
CAC 40								
GAS → INDEX	0.0485 *	0.1585	0.2285	0.3584	0.5983	0.6503	0.7102	0.6797
GAS → IPI	0.3088	0.0475*	0.1338	0.2228	0.1524	0.0478*	0.0306*	0.09788
GAS → IR	0.2454	0.0829	0.0598	0.0649	0.0091**	0.0028**	0.0052**	0.0107 *
OIL → INDEX	0.4334	0.5211	0.8561	0.6683	0.1990	0.0680	0.1117	0.0995
OIL → IPI	0.0669	0.4597	0.2305	0.4781	0.5555	0.5658	0.0057**	0.0003***
OIL → IR	0.6331	0.3988	0.8984	0.6803	0.8268	0.6590	0.7944	0.9068
COAL → INDEX	0.7257	0.9580	0.6292	0.6831	0.8426	0.9458	0.8386	0.6376
COAL → IPI	0.7935	0.4122	0.4538	0.5632	0.9121	0.9314	0.9726	0.1933
COAL → IR	0.0119 *	0.0076 **	0.0094 **	0.0037**	0.0013 **	0.0003***	0.0006***	0.0024 **
INDEX → GAS	0.0019 **	0.0045 **	0.0221 *	0.0114 *	0.0781	0.0544	0.0833	0.0554
INDEX → OIL	0.0482	0.2636	0.4513	0.1860	0.3628	0.2351	0.5464	0.6848
INDEX → COAL	0.0136 *	0.0519	0.1624	0.2756	0.3348	0.3621	0.3324	0.2411
INDEX → IPI	0.1783	0.389	0.0173 *	0.0588	0.2465	0.4116	0.3103	0.1144
INDEX → IR	0.2623	0.671	0.8864	0.9749	0.8501	0.8539	0.8809	0.9391
IPI → INDEX	0.7883	0.3549	0.3309	0.3510	0.6806	0.6485	0.7795	0.4905
IR → INDEX	0.6578	0.1780	0.3810	0.5292	0.5802	0.6665	0.7762	0.8049
FTSE 100								
GAS → INDEX	0.1410	0.4237	0.4046	0.5406	0.6469	0.6718	0.6945	0.3232
GAS → IPI	0.3803	0.5186	0.4851	0.2531	0.479	0.1015	0.02316 *	0.0048**
GAS → IR	0.1144	0.1365	0.1606	0.2196	0.0086**	0.0064**	0.0026**	0.0045**
OIL → INDEX	0.3133	0.2946	0.5976	0.5392	0.2261	0.1232	0.1137	0.0941
OIL → IPI	0.1749	0.8204	0.7933	0.9099	0.6798	0.611	0.3417	0.0000 ***
OIL → IR	0.8828	0.4734	0.9734	0.9641	0.9979	0.9918	0.9347	0.9337
COAL → INDEX	0.4723	0.9313	0.5604	0.7870	0.8392	0.9789	0.9458	0.3257
COAL → IPI	0.6741	0.6879	0.5197	0.5210	0.7162	0.6725	0.6406	0.2416
COAL → IR	0.0724	0.0411*	0.1193	0.0245*	0.0089**	0.0024**	0.0003***	0.0000***
INDEX → GAS	0.0037 **	0.0086 **	0.0435 *	0.0177 *	0.0839	0.0980	0.1180	0.1197
INDEX → OIL	0.0286 *	0.1949	0.3186	0.1325	0.2546	0.1538	0.4298	0.5210
INDEX → COAL	0.0154 *	0.0671	0.1819	0.3362	0.5129	0.5649	0.5519	0.2639
INDEX → IPI	0.07675	0.4006	0.6583	0.5359	0.7063	0.7160	0.8107	0.1175
INDEX → IR	0.0299 *	0.1210	0.5606	0.6017	0.6233	0.7309	0.7831	0.6272
IPI → INDEX	0.8160	0.7953	0.5887	0.4564	0.5535	0.4239	0.2533	0.3052
IR → INDEX	0.3847	0.2525	0.3775	0.3855	0.423	0.4881	0.4979	0.5574

Lags	1	2	3	4	6	8	10	12
OBX								
GAS → INDEX	0.4475	0.9179	0.9271	0.9943	0.9352	0.7782	0.8042	0.6103
GAS → IPI	0.1712	0.4149	0.107	0.1267	0.2834	0.4772	0.6556	0.618
GAS → IR	0.0925	0.0652	0.1325	0.2196	0.0038**	0.0017**	0.0017**	0.0055**
OIL → INDEX	0.7254	0.7429	0.7094	0.3642	0.0809	0.07281	0.2022	0.1879
OIL → IPI	0.4965	0.6674	0.8450	0.9601	0.3754	0.5155	0.6731	0.4923
OIL → IR	0.5956	0.8110	0.9748	0.9112	0.9876	0.9565	0.9719	0.9777
COAL → INDEX	0.0259 *	0.2276	0.2943	0.4616	0.2829	0.5169	0.9278	0.4792
COAL → IPI	0.2160	0.5527	0.4274	0.4400	0.7747	0.7759	0.8360	0.8801
COAL → IR	0.1596	0.1628	0.3876	0.4561	0.1028	0.0697	0.1925	0.0823
INDEX → GAS	0.0078 **	0.0277 *	0.0826	0.0210 *	0.0668	0.1668	0.0904	0.1767
INDEX → OIL	0.0033 **	0.0179 *	0.0967	0.4686	0.1160	0.2158	0.4361	0.2799
INDEX → COAL	0.0012 **	0.0255 *	0.1165	0.1123	0.1168	0.0414 *	0.0259 *	0.0280 *
INDEX → IPI	0.9840	0.7737	0.6993	0.7648	0.8823	0.5426	0.2026	0.2856
INDEX → IR	0.0603	0.0670	0.4254	0.4627	0.5157	0.8637	0.8106	0.5492
IPI → INDEX	0.2759	0.4296	0.5881	0.7906	0.6074	0.5693	0.5565	0.5013
IR → INDEX	0.0048 **	0.0203 *	0.0095**	0.0014**	0.0113 *	0.0439 *	0.0648	0.0499 *
BEL 20								
GAS → INDEX	0.2745	0.7048	0.4294	0.5547	0.4056	0.5072	0.4396	0.3268
GAS → IPI	0.4661	0.6841	0.7786	0.7923	0.6308	0.5262	0.3624	0.4576
GAS → IR	0.3157	0.1236	0.1362	0.0767	0.01762 *	0.0047**	0.0053**	0.0124*
OIL → INDEX	0.8173	0.8643	0.7854	0.6284	0.2194	0.0709	0.1244	0.1186
OIL → IPI	0.6466	0.3397	0.7556	0.8771	0.8604	0.9356	0.7647	0.3805
OIL → IR	0.7652	0.4899	0.7319	0.6874	0.9042	0.4954	0.6271	0.5951
COAL → INDEX	0.5365	0.9585	0.6497	0.8080	0.4922	0.7748	0.9198	0.9376
COAL → IPI	0.4306	0.8946	0.7806	0.9644	0.9769	0.4466	0.4230	0.9040
COAL → IR	0.0220 *	0.0344*	0.0388*	0.03847 *	0.02287 *	0.0037**	0.0035**	0.0079**
INDEX → GAS	0.0035 **	0.0094 **	0.0503	0.0109 *	0.0732	0.1393	0.1049	0.1424
INDEX → OIL	0.0094 **	0.1299	0.3156	0.2534	0.1639	0.0521	0.0926	0.1700
INDEX → COAL	0.0229 *	0.0967	0.3331	0.3089	0.5757	0.5469	0.6519	0.2147
INDEX → IPI	0.0046**	0.0109 *	0.0261 *	0.0628	0.1347	0.3072	0.0507	0.0412 *
INDEX → IR	0.0822	0.2707	0.7769	0.6579	0.0359 *	0.0631	0.2278	0.2776
IPI → INDEX	0.09237	0.1170	0.1308	0.2351	0.4713	0.3780	0.5178	0.4638
IR → INDEX	0.1673	0.2330	0.3074	0.4177	0.2907	0.6317	0.6156	0.7029
FTSE MIB								
GAS → INDEX	0.1506	0.4325	0.3656	0.5689	0.7668	0.9020	0.9430	0.9530
GAS → IPI	0.9130	0.0819	0.2178	0.3482	0.0934	0.0319*	0.0011**	0.0022**
GAS → IR	0.2168	0.0815	0.1619	0.2087	0.1349	0.0361*	0.0577	0.0861
OIL → INDEX	0.3793	0.3893	0.5618	0.6210	0.1870	0.0356 *	0.0731	0.1216
OIL → IPI	0.1375	0.3969	0.2800	0.5222	0.7151	0.7706	0.0129*	0.0000***
OIL → IR	0.8798	0.4388	0.3639	0.4737	0.4802	0.1903	0.2138	0.2113
COAL → INDEX	0.6286	0.9903	0.6768	0.8479	0.9368	0.9918	0.9939	0.9742
COAL → IPI	0.6128	0.2823	0.2971	0.5725	0.8299	0.8020	0.9415	0.2149
COAL → IR	0.0191*	0.0259*	0.0920	0.0901	0.1540	0.0940	0.1165	0.1331
INDEX → GAS	0.01239 *	0.0184 *	0.06319	0.06498	0.2061	0.2067	0.2727	0.1266
INDEX → OIL	0.1684	0.5347	0.8245	0.5749	0.8266	0.5412	0.8058	0.9032
INDEX → COAL	0.1108	0.3362	0.6389	0.7535	0.8843	0.8979	0.9513	0.7768
INDEX → IPI	0.8602	0.9858	0.2763	0.2869	0.2724	0.3911	0.3496	0.1163
INDEX → IR	0.3412	0.1033	0.1332	0.1404	0.1527	0.1267	0.1517	0.3205
IPI → INDEX	0.6723	0.4987	0.3180	0.4650	0.8069	0.5161	0.6714	0.6560
IR → INDEX	0.0000***	0.0000***	0.0000***	0.0000***	0.0002***	0.0004***	0.0009***	0.0031 **
OMXCPI								
GAS → INDEX	0.8446	0.06197	0.06652	0.1147	0.2995	0.7861	0.9623	0.7816

Lags	1	2	3	4	6	8	10	12
GAS → IPI	0.8841	0.6505	0.2206	0.0391*	0.0214*	0.0321*	0.0228*	0.0430*
GAS → IR	0.3927	0.1178	0.0901	0.1575	0.0100*	0.0179*	0.0164*	0.0369*
OIL → INDEX	0.8007	0.8904	0.9884	0.1172	0.1262	0.0831	0.0424 *	0.0523
OIL → IPI	0.0005***	0.0011**	0.0012**	0.0062**	0.0120*	0.0191*	0.0027**	0.0058**
OIL → IR	0.4776	0.6865	0.8841	0.9033	0.9265	0.9562	0.9820	0.9929
COAL → INDEX	0.1666	0.2239	0.0449*	0.0723	0.0096**	0.08708	0.1820	0.0413*
COAL → IPI	0.0753	0.1655	0.1456	0.1278	0.3618	0.1883	0.1207	0.1273
COAL → IR	0.0103*	0.0070**	0.0042**	0.0071**	0.0108*	0.0048**	0.0035**	0.0028**
INDEX → GAS	0.0099 **	0.0404 *	0.0825	0.0152 *	0.1060	0.0279 *	0.0030**	0.0078 **
INDEX → OIL	0.0261 *	0.2684	0.6227	0.3232	0.5204	0.6105	0.8084	0.9025
INDEX → COAL	0.0286*	0.2280	0.6047	0.7190	0.6323	0.2904	0.3135	0.4735
INDEX → IPI	0.1588	0.4745	0.6695	0.5691	0.9366	0.9957	0.9969	0.7812
INDEX → IR	0.0023 **	0.0306*	0.2440	0.1125	0.0572	0.0749	0.0967	0.0894
IPI → INDEX	0.5016	0.7266	0.8015	0.5841	0.8138	0.6997	0.3483	0.0860
IR → INDEX	0.7852	0.7227	0.8950	0.7848	0.4600	0.4996	0.3185	0.4298
AEX								
GAS → INDEX	0.2546	0.6327	0.7080	0.6824	0.5359	0.1192	0.0527	0.0698
GAS → IPI	0.6593	0.5556	0.5898	0.6611	0.8443	0.6404	0.7966	0.8659
GAS → IR	0.4516	0.1773	0.2245	0.1047	0.0033**	0.0018**	0.0007***	0.0017**
OIL → INDEX	0.9176	0.8640	0.9147	0.7063	0.4186	0.0346 *	0.0790	0.0503
OIL → IPI	0.01695*	0.02305*	0.0879	0.07754	0.3168	0.4612	0.5571	0.3850
OIL → IR	0.7872	0.5681	0.9109	0.8966	0.9598	0.8288	0.9100	0.9783
COAL → INDEX	0.2680	0.7694	0.6405	0.7279	0.4876	0.4644	0.4062	0.0876
COAL → IPI	0.7900	0.0293*	0.1073	0.1034	0.2956	0.1789	0.1864	0.3159
COAL → IR	0.0321*	0.0157*	0.0066**	0.0021**	0.0017**	0.0003***	0.0000***	0.0000 ***
INDEX → GAS	0.0064 **	0.0216 *	0.0761	0.1054	0.3992	0.0891	0.1404	0.2433
INDEX → OIL	0.0088**	0.1259	0.3124	0.4355	0.6383	0.3576	0.5452	0.6179
INDEX → COAL	0.0432*	0.3034	0.6459	0.6323	0.6974	0.3606	0.5665	0.3775
INDEX → IPI	0.0005***	0.0098**	0.0022**	0.0011**	0.0104 *	0.0855	0.1953	0.2916
INDEX → IR	0.0600	0.3193	0.4388	0.7612	0.3759	0.6468	0.4960	0.6935
IPI → INDEX	0.9890	0.9177	0.9490	0.9979	0.9987	0.9964	0.9975	0.9915
IR → INDEX	0.4974	0.4898	0.7164	0.8472	0.2594	0.2942	0.2057	0.2876

Notes: One, two, or three asterisks indicate significance at a 10%, 5%, or 1% level, respectively.

The Granger tests are based on a linear VAR model, where p is equal to 1, 2, 3, 4, 6, 8, 10 and 12 months, respectively. The table provides the p-values of rejection of the null hypothesis.

GAS → INDEX is the null hypothesis of no Granger causality from GAS returns to INDEX returns.

GAS → IPI is the null hypothesis of no Granger causality from GAS returns to IPI.

GAS → IR is the null hypothesis of no Granger causality from GAS returns to IR.

OIL → INDEX is the null hypothesis of no Granger causality from OIL returns to INDEX returns.

OIL → IPI is the null hypothesis of no Granger causality from OIL returns to IPI.

OIL → IR is the null hypothesis of no Granger causality from OIL returns to IR.

COAL → INDEX is the null hypothesis of no Granger causality from COAL returns to INDEX returns.

COAL → IPI is the null hypothesis of no Granger causality from COAL returns to IPI.

COAL → IR is the null hypothesis of no Granger causality from COAL returns to IR.

INDEX → GAS is the null hypothesis of no Granger causality from INDEX returns to GAS returns.

INDEX → OIL is the null hypothesis of no Granger causality from INDEX returns to OIL returns.

INDEX → COAL is the null hypothesis of no Granger causality from INDEX returns to COAL returns.

INDEX → IPI is the null hypothesis of no Granger causality from INDEX returns to IPI.

INDEX → IR is the null hypothesis of no Granger causality from INDEX returns to IR.

IPI → INDEX is the null hypothesis of no Granger causality from IPI to INDEX returns.

IR → INDEX is the null hypothesis of no Granger causality from IR to INDEX returns.

Appendix 10. Results of the DLM regressions

	Obs.	Index L(1)	GAS	OIL	COAL	IPI	IR	D1	D1* GAS	D1* OIL	D1* COAL	D1* IPI	D1* IR	D2	D2* GAS	D2* OIL	D2* COAL	D2* IPI	D2* IR	Constant
Regression 1: Regressions using basic models without transformations																				
DAX Adj.R ² 0.011	169	NA	0.035 (0.026)	0.225*** (0.048)	-0.15*** (0.057)	-0.024 (0.153)	-0.013 (0.009)	NA	NA	NA	NA	NA	NA	NA	NA	NA	NA	NA	NA	0.006 (0.004)
CAC 40 Adj.R ² 0.132	168	NA	0.041* (0.024)	0.227*** (0.046)	-0.139** (0.058)	-0.136 (0.221)	-0.019 (0.011)	NA	NA	NA	NA	NA	NA	NA	NA	NA	NA	NA	NA	0.004 (0.004)
FTSE 100 Adj.R ² 0.155	169	NA	0.035* (0.019)	0.198*** (0.034)	-0.099*** (0.038)	-0.021 (0.134)	-0.014 (0.016)	NA	NA	NA	NA	NA	NA	NA	NA	NA	NA	NA	NA	0.003 (0.003)
OBX Adj.R ² 0.312	168	-0.14** (0.064)	0.059** (0.024)	0.403*** (0.046)	-0.066 (0.049)	0.021 (0.140)	-0.007 (0.037)	NA	NA	NA	NA	NA	NA	NA	NA	NA	NA	NA	NA	0.008** (0.004)
BEL 20 Adj.R ² 0.059	168	-0.014 (0.074)	0.260 (0.022)	0.155*** (0.043)	-0.075* (0.043)	0.134 (0.111)	-0.008 (0.008)	NA	NA	NA	NA	NA	NA	NA	NA	NA	NA	NA	NA	0.004 (0.003)
FTSE MIB Adj.R ² 0.097	169	-0.090 (0.077)	0.053* (0.029)	0.267*** (0.050)	-0.198*** (0.057)	-0.075 (0.122)	-0.058* (0.033)	NA	NA	NA	NA	NA	NA	NA	NA	NA	NA	NA	NA	0.001 (0.005)
OMXCPI Adj.R ² 0.118	168	0.13 (0.073)	0.026 (0.021)	0.123*** (0.032)	-0.084** (0.042)	-0.077 (0.082)	-0.01** (0.006)	NA	NA	NA	NA	NA	NA	NA	NA	NA	NA	NA	NA	0.001*** (0.00)
AEX Adj. R ² 0.14	168	-0.123 (0.071)	0.053** (0.020)	0.181*** (0.039)	-0.112*** (0.041)	0.097 (0.170)	-0.008 (0.011)	NA	NA	NA	NA	NA	NA	NA	NA	NA	NA	NA	NA	0.007** (0.003)
Regression 2: Regressions including dummies D1 and D2																				
DAX Adj.R ² 0.075	169	0.030 (0.083)	0.036 (0.027)	0.197*** (0.050)	-0.17*** (0.058)	-0.019 (0.164)	-0.013 (0.009)	0.009 (0.020)	NA	NA	NA	NA	NA	0.0001 (0.016)	NA	NA	NA	NA	NA	0.007 (0.004)
CAC 40 Adj.R ² 0.120	168	NA	0.042* (0.025)	0.228*** (0.047)	-0.144** (0.061)	-0.135 (0.226)	-0.020* (0.012)	0.001 (0.020)	NA	NA	NA	NA	NA	0.004 (0.016)	NA	NA	NA	NA	NA	0.003 (0.004)
FTSE 100 Adj.R ² 0.147	169	NA	0.034* (0.019)	0.197*** (0.035)	-0.101*** (0.038)	-0.015 (0.135)	-0.017 (0.016)	0.009 (0.012)	NA	NA	NA	NA	NA	0.005 (0.012)	NA	NA	NA	NA	NA	0.001 (0.003)
OBX Adj.R ² 0.306	168	-0.15** (0.064)	0.060** (0.024)	0.405*** (0.047)	-0.062 (0.050)	0.017 (0.141)	-0.001 (0.038)	-0.010 (0.015)	NA	NA	NA	NA	NA	-0.008 (0.015)	NA	NA	NA	NA	NA	0.009** (0.004)
BEL 20 Adj.R ² 0.048	168	-0.016 (0.075)	0.027 (0.022)	0.156*** (0.044)	-0.074* (0.044)	0.135 (0.112)	-0.008 (0.008)	-0.008 (0.017)	NA	NA	NA	NA	NA	-0.003 (0.013)	NA	NA	NA	NA	NA	0.004 (0.004)
FTSE MIB Adj.R ² 0.093	169	-0.095 (0.077)	0.052* (0.03)	0.266*** (0.051)	-0.20*** (0.058)	-0.071 (0.123)	-0.07** (0.035)	0.017 (0.019)	NA	NA	NA	NA	NA	0.013 (0.019)	NA	NA	NA	NA	NA	0.001 (0.005)
OMXCPI Adj.R ² 0.109	168	0.012 (0.074)	0.026 (0.021)	0.122*** (0.033)	-0.088** (0.043)	-0.081 (0.082)	-0.012** (0.006)	0.009 (0.014)	NA	NA	NA	NA	NA	-0.003 (0.014)	NA	NA	NA	NA	NA	0.001*** (0.004)

AEX Adj.R ² 0.130	168	-0.121 (0.072)	0.053*** (0.021)	0.181*** (0.032)	-0.11*** (0.041)	0.100 (0.171)	-0.009 (0.011)	-0.003 (0.013)	NA	NA	NA	NA	NA	0.004 (0.013)	NA	NA	NA	NA	NA	0.007** (0.003)
--	-----	-------------------	----------------------------	----------------------------	----------------------------	------------------	-------------------	-------------------	----	----	----	----	----	------------------	----	----	----	----	----	---------------------------

Regression 3: Regressions including D1 and its interactions with other explanatory variables

DAX Adj.R ² 0.097	169	NA	0.036 (0.027)	0.229*** (0.049)	-0.143** (0.058)	0.031 (0.161)	-0.03** (0.012)	0.039 (0.040)	0.019 (0.273)	-0.256 (0.508)	-0.188 (0.713)	1.294 (2.370)	0.029 (0.022)	NA	NA	NA	NA	NA	NA	0.005 (0.004)
CAC 40 Adj.R ² 0.113	168	NA	0.046* (0.026)	0.229*** (0.048)	-0.128** (0.060)	-0.184 (0.233)	-0.021* (0.012)	0.031 (0.062)	-0.070 (0.351)	-0.054 (0.558)	-0.187 (1.040)	0.992 (1.180)	-0.017 (0.115)	NA	NA	NA	NA	NA	NA	0.004 (0.004)
FTSE 100 Adj.R ² 0.148	169	NA	0.039** (0.020)	0.199*** (0.036)	-0.094** (0.043)	-0.039 (0.136)	-0.018 (0.018)	0.033* (0.022)	-0.168* (0.144)	-0.285* (0.172)	0.206 (0.202)	-0.360 (0.647)	0.050 (0.053)	NA	NA	NA	NA	NA	NA	0.002 (0.003)
OBX Adj.R ² 0.318	168	-0.15** (0.065)	0.061** (0.025)	0.42*** (0.048)	-0.043 (0.056)	0.017 (0.142)	-0.009 (0.039)	0.014 (0.020)	-0.082 (0.106)	-0.433* (0.230)	-0.137 (0.195)	1.846 (1.147)	0.207 (0.136)	NA	NA	NA	NA	NA	NA	0.009** (0.004)
BEL 20 Adj.R ² 0.058	168	-0.002 (0.075)	0.034 (0.023)	0.160*** (0.045)	-0.070 (0.049)	0.131 (0.115)	-0.013 (0.009)	0.047 (0.101)	-0.629 (1.663)	-0.448 (1.121)	0.411 (0.913)	1.708 (2.716)	-0.100 (0.462)	NA	NA	NA	NA	NA	NA	0.004 (0.004)
FTSE MIB Adj.R ² 0.081	169	-0.093 (0.078)	0.056* (0.031)	0.273*** (0.053)	-0.23*** (0.066)	-0.065 (0.125)	-0.066 (0.039)	0.039 (0.029)	-0.241 (0.219)	-0.342 (0.272)	0.374 (0.284)	0.747 (1.993)	0.082 (0.115)	NA	NA	NA	NA	NA	NA	0.00002 (0.005)
OMXCPI Adj.R ² 0.082	168	0.072 (0.073)	0.016 (0.022)	0.114*** (0.034)	-0.004 (0.048)	-0.084 (0.088)	-0.013 (0.009)	0.021 (0.021)	-0.133 (0.100)	-0.262 (0.202)	-0.02 (0.131)	-0.11 (0.316)	0.004 (0.013)	NA	NA	NA	NA	NA	NA	0.009*** (0.003)
AEX Adj.R ² 0.145	168	-0.125 (0.072)	0.057*** (0.022)	0.186*** (0.041)	-0.106** (0.049)	0.092 (0.178)	-0.020 (0.012)	0.020 (0.018)	-0.120 (0.085)	-0.205 (0.208)	0.106 (0.123)	0.139 (0.723)	0.051 (0.035)	NA	NA	NA	NA	NA	NA	0.007* (0.003)

Regression 4: Regressions including D2 and its interactions with other explanatory variables

DAX Adj.R ² 0.109	169	NA	0.024 (0.034)	0.208*** (0.051)	-0.067 (0.084)	-0.045 (0.158)	-0.01 (0.012)	NA	NA	NA	NA	NA	NA	0.022 (0.023)	0.023 (0.060)	0.211 (0.323)	-0.170 (0.131)	-0.22 (1.36)	-0.083 (0.067)	0.006 (0.004)
CAC 40 Adj.R ² 0.129	168	NA	0.034 (0.031)	0.230*** (0.050)	-0.122 (0.077)	-0.075 (0.228)	-0.017 (0.012)	NA	NA	NA	NA	NA	NA	0.017 (0.020)	0.028 (0.056)	-0.256 (0.256)	-0.024 (0.129)	-2.77** (1.32)	-0.068 (0.057)	0.003 (0.004)
FTSE 100 Adj.R ² 0.155	169	NA	0.024 (0.023)	0.196*** (0.036)	-0.065 (0.049)	-0.030 (0.134)	-0.010 (0.016)	NA	NA	NA	NA	NA	NA	0.027 (0.016)	0.039 (0.048)	-0.039 (0.176)	-0.075 (0.081)	4.481* (2.647)	-0.083 (0.080)	0.003 (0.003)
OBX Adj.R ² 0.344	168	-0.14** (0.065)	0.041 (0.029)	0.393*** (0.048)	-0.054 (0.062)	-0.078 (0.141)	0.014 (0.038)	NA	NA	NA	NA	NA	NA	0.018 (0.017)	0.071 (0.053)	0.222 (0.209)	-0.208* (0.120)	1.97*** (0.680)	-0.148 (0.147)	0.009** (0.004)
BEL 20 Adj.R ² 0.044	168	-0.026 (0.077)	0.035 (0.028)	0.154*** (0.047)	-0.083 (0.058)	0.158 (0.116)	-0.006 (0.008)	NA	NA	NA	NA	NA	NA	0.003 (0.016)	-0.046 (0.050)	-0.055 (0.188)	0.102 (0.099)	-0.602 (0.463)	-0.071 (0.047)	0.004 (0.004)
FTSE MIB Adj.R ² 0.78	169	-0.103 (0.079)	0.052 (0.036)	0.266*** (0.052)	-0.144* (0.075)	-0.072 (0.124)	-0.060* (0.037)	NA	NA	NA	NA	NA	NA	0.018 (0.025)	0.004 (0.068)	-0.053 (0.289)	-0.147 (0.129)	0.008 (1.116)	-0.049 (0.135)	0.0001 (0.005)
OMXCPI Adj.R ² 0.068	168	0.055 (0.076)	0.016 (0.026)	0.118*** (0.034)	-0.072 (0.054)	-0.033 (0.089)	-0.008 (0.006)	NA	NA	NA	NA	NA	NA	0.018 (0.017)	-0.018 (0.055)	0.290 (0.223)	0.084 (0.106)	-0.243 (0.299)	-0.076* (0.041)	0.009** (0.004)
AEX Adj.R ² 0.158	168	-0.116 (0.072)	0.038 (0.025)	0.179*** (0.040)	-0.069 (0.054)	0.081 (0.175)	-0.002 (0.012)	NA	NA	NA	NA	NA	NA	0.010 (0.019)	0.123* (0.067)	0.331 (0.222)	-0.33** (0.121)	2.055* (1.009)	-0.123 (0.054)	0.006* (0.003)

Notes: See note for Table 7.

